

HP SCAuto for Operations Manager for Unix

For the UNIX Operating System

Software Version: 1.50

User Guide

Document Release Date: March 2010
Software Release Date: March 2010



Legal Notices

Warranty

The only warranties for HP products and services are set forth in the express warranty statements accompanying such products and services. Nothing herein should be construed as constituting an additional warranty. HP shall not be liable for technical or editorial errors or omissions contained herein.

The information contained herein is subject to change without notice.

Restricted Rights Legend

Confidential computer software. Valid license from HP required for possession, use or copying. Consistent with FAR 12.211 and 12.212, Commercial Computer Software, Computer Software Documentation, and Technical Data for Commercial Items are licensed to the U.S. Government under vendor's standard commercial license.

Copyright Notices

© Copyright 1996-2010 Hewlett-Packard Development Company, L.P.

Trademark Notices

Microsoft® and Windows® are U.S. registered trademarks of Microsoft Corporation. UNIX® is a registered trademark of The Open Group.

HP ServiceCenter, HP SCAuto, and HP Operations Manager are registered trademarks of Hewlett-Packard Company.

Documentation Updates

The title page of this document contains the following identifying information:

- Software Version number, which indicates the software version.
- Document Release Date, which changes each time the document is updated.
- Software Release Date, which indicates the release date of this version of the software.

To check for recent updates or to verify that you are using the most recent edition of a document, go to:

<http://h20230.www2.hp.com/selfsolve/manuals>

This site requires that you register for an HP Passport and sign in. To register for an HP Passport ID, go to:

<http://h20229.www2.hp.com/passport-registration.html>

Or click the **New users - please register** link on the HP Passport login page.

You will also receive updated or new editions if you subscribe to the appropriate product support service. Contact your HP sales representative for details.

Support

Visit the HP Software Support Online web site at:

www.hp.com/go/hpsoftwaresupport

This web site provides contact information and details about the products, services, and support that HP Software offers.

HP Software online support provides customer self-solve capabilities. It provides a fast and efficient way to access interactive technical support tools needed to manage your business. As a valued support customer, you can benefit by using the support web site to:

- Search for knowledge documents of interest
- Submit and track support cases and enhancement requests
- Download software patches
- Manage support contracts
- Look up HP support contacts
- Review information about available services
- Enter into discussions with other software customers
- Research and register for software training

Most of the support areas require that you register as an HP Passport user and sign in. Many also require a support contract. To register for an HP Passport ID, go to:

<http://h20229.www2.hp.com/passport-registration.html>

To find more information about access levels, go to:

http://h20230.www2.hp.com/new_access_levels.jsp

Contents

1	Introduction	9
	Overview	9
	Knowledge Requirements	9
	Determining Current Product Version	10
	What's New	10
	SCAuto for OMU	10
	ServiceCenter	11
	Core Applications	11
	Additional Applications	11
	OMU	11
	Functional Areas	11
	Network Node Manager	12
	About SCAuto for OMU	12
	Operational Concepts	14
	Bi-directional Integration	14
	Planning Your ServiceCenter and OMU Integration	16
	Mode 1: Uni-directional Automatic Notification from OMU	16
	Process and Data Flow	16
	Mode 2: Bi-directional Exchange (Default Mode of Operation)	17
	Process and Data Flow	18
	Mode 3: Automatic Notification from OMU via Trouble Ticket Interface (TTI)	19
	Mode 4: New ServiceCenter Tickets Generate OMU Events	20
	Mode 5: Application Monitoring — OMU Monitors ServiceCenter	20
	Mode 6: Combined User Interface — Launch ServiceCenter from OMU Windows (for OMU 8 Only)	21
	OMU Business Logic Topics	22
	ServiceCenter Business Logic Topics	23
	SCAuto for OMU Business Logic Topics	24
2	Installation	25
	System Requirements	25
	Required Kernel Parameters	25
	Installation Requirements	26
	Installing SCAuto for OMU	26
	Install Procedure	27
	Uninstalling SCAuto for OMU	27
3	Basic Operations	29
	Starting and Stopping SCAuto for OMU Processes	29
	Starting SCAuto for OMU	29

Stopping SCAuto for OMU	32
Basic Maintenance	32
scito.ini Parameters	32
Basic Configuration	33
Troubleshooting	34
4 Product Architecture	37
Application Integration (for OMU 8 Only)	37
ServiceCenter Menu Options	38
Incident List	38
Event Integration	39
Integration Components	40
scevmon	41
sctoito	42
scfromitoTTI	42
scfromitoMSI	42
scfromitoMEI	42
5 Configuration	43
SCAuto for OMU Business Logic Configuration	43
Configuration Overview	43
OMU Variables	44
ServiceCenter TCL Event Object	47
Summary of ServiceCenter TCL Commands	47
create_sc_event	48
set_evtype	48
set_evfield	48
set_evuser	49
print	49
send	49
tcl_logprint	49
Static Map File	50
OMU Message Filtering the event.ini File	51
Sections	51
Using TTI - Trouble Ticketing Interface	55
Default Behavior	55
Example eventmapMSI.tcl Script	55
TCL Event Mapping from ServiceCenter to OMU	57
Configuration Overview	57
ServiceCenter TCL Variables	58
OMU Programming APIs as TCL Commands	59
Summary of OMU TCL Commands	59
opcif_write	59
opcmsg_annotation_add	61
opcmsg_ack	61
opcmsg_unack	61
opcmsg_own	61
opcmsg_disown	61

opcmg_op_action_start.....	61
opcmg_cma_set.....	61
tcl_logprint.....	62
Event Configuration File.....	62
Sections.....	62
Default Behavior.....	63
Default pmo.tcl Script.....	63
OMU Business Logic Configuration.....	66
General Process.....	66
Requirements Analysis.....	66
Design Phase.....	67
Implementation Phase.....	67
Design Considerations.....	67
Implementation Steps.....	67
Configuring OMU 8.....	68
Configuring OMU 9.....	82
ServiceCenter Business Logic Configuration.....	88
ServiceCenter Event Services.....	88
Event Registration.....	89
Event Maps.....	90
ServiceCenter Incident Management.....	91
6 Scenarios.....	93
Uni-directional Automatic Incident Ticket Creation (Mode 1).....	93
Bi-directional Incident Ticket/OMU Message Creation/Update/Close (Mode 2).....	94
Creating Incident Tickets with Trouble Ticket Interface (Mode 3).....	94
Node-based Incident Tickets.....	94
Cause-based Incident Tickets Per Node.....	95
OMU Message Group into ServiceCenter Category.....	95

1 Introduction

This chapter provides an introduction to HP SCAuto for Operations Manager for Unix (OMU).

It covers the following topics:

- Overview
- ServiceCenter
- About SCAuto for OMU
- Operational Concepts
- Planning Your ServiceCenter and OMU Integration
- OMU Business Logic Topics
- ServiceCenter Business Logic Topics
- SCAuto for OMU Business Logic Topics

Overview

Welcome to the *HP SCAuto for Operations Manager for Unix User Guide*. This guide provides instructions on how to implement the interface between OMU and ServiceCenter.

SCAuto for OMU allows you to automate the process of creating, updating, and closing trouble tickets in ServiceCenter, based on OMU Message Stream Interface (MSI) and Message Event Interface (MEI) events. It has the capability of annotating, owning, and acknowledging OMU messages from modifications done on ServiceCenter incident tickets.

This product is part of the suite of SCAuto interface products that integrate ServiceCenter with premier Network and Systems Management tools. The interface is based on event messages sent over TCP connection to the ServiceCenter server. Additional information about SCAuto can be found in the *SCAuto Applications for Windows NT and UNIX Guide*.



Throughout the guide, we refer to ServiceCenter only, however, the instructions work for both ServiceCenter and Service Manager. If you are using Service Manager just replace the term “ServiceCenter” with “Service Manager”.

Knowledge Requirements

This guide assumes the reader has:

- Working knowledge of ServiceCenter applications, ServiceCenter Client/Server, and the OMU graphical user interface, as well as a basic understanding of ServiceCenter applications and Event Services. While some procedures for these applications are explained, others are referenced. See the appropriate ServiceCenter documentation for a more detailed explanation.

- Familiarity with OMU and its components including the Network Node Manager (NNM). Working knowledge of the operating system environment in which you are working (such as a GUI or text-based environment).
- (As an Administrator) a thorough knowledge of the operating system where ServiceCenter, SCAuto, and the SCAuto for OMU product will be installed and implemented.

Determining Current Product Version

Knowing the current version of your SCAuto for OMU product is valuable when contacting HP Customer Support and deciding when to upgrade. From a ServiceCenter client, see the About menu to determine the current version of ServiceCenter.

Each of the executables `scfromitoMEI`, `scfromitoMSI`, `scfromitoTTI` and `sctoito` can be given a command line argument of “-v” to display their current versions and copyright information.

What's New

This new version adds the ability to support integration between ServiceCenter and OMU 9.

SCAuto for OMU

SCAuto for OMU offers integration between ServiceCenter applications and OMU. The interface of these two applications allows systems management functions of OMU to be extended and enhanced by the Incident Management functions of ServiceCenter.

This integration benefits customers of ServiceCenter and OMU by providing these features:

- A more robust environment for production IT operations
- Automated ticketing functions supported by the Incident Management processes
- The ability to structure and organize the real-time responses supported by the enterprise systems management functions.

The sections that follow give a high-level view of the operational concepts in this integration. These sections are:

- ServiceCenter
- OMU
- SCAuto for OMU
- Operational concepts
- Planning your ServiceCenter and OMU integration
- OMU business logic topics
- ServiceCenter business logic topics
- SCAuto for OMU business logic topics

ServiceCenter

Core Applications

ServiceCenter contains four core applications:

- Incident Management, which is a incident-tracking tool integrated with knowledge tools to speed resolution.
- Configuration Management, which maintains an operational database of assets used in the enterprise.
- Change Management, which allows you to manage the evolution of the enterprise to meet changing needs and requirements as they arise.
- Problem Management, which a problem-tracking tool integrated with knowledge tools to speed resolution.

Configuration Management tracks what the enterprise was expected to be, Incident Management works with the current state, Change Management offers a way to manage towards the desired final product, and Problem Management works with final resolution of issues and problems.

Additional Applications

ServiceCenter provides additional applications that support and enhance the core applications.

The additional ServiceCenter applications are described next:

- Service Management provides a call-based front end applications.
- Service Level Management (SLM) offers significant value with service desk automation based on service level agreements (SLAs).
- Request Management maintains catalogs of services and items and organizes the delivery of these.
- Schedule Maintenance enables you to set up and execute recurring tasks.

OMU

OMU is the foundation of HP OpenView's operational control of IT resources. It is a part of HP's OpenView suite of management applications.

OMU features data, event, and process level integration with other OpenView applications. It provides a central management console for enterprise systems management actions. It is built around a robust framework architecture, with an event console at the core.

Functional Areas

OMU has several functional areas that are built from the event messages handled by the event console. These functional areas are described next:

- Message groups and message templates directly impact the events.
- User groups collect OMU operators and allocate authorization roles.
- Node groups perform a similar function for the managed resources.
- Application groups structure the OMU monitored applications into organized, manageable components.

Network Node Manager

OMU incorporates the OpenView Network Node Manager (NNM) product. It performs SNMP-based network monitoring. It acts as a perfect companion for the event console of OMU because it generates event messages from incidents and faults on the network.

About SCAuto for OMU

SCAuto for OMU is designed in a modular way. Specific modules perform specific data processing functions. There are three separate modules that connect to three specific APIs:

- The Message Stream Interface (MSI) is a registration API that delivers notice whenever new events arrive at the event console.
- The Message Event Interface (MEI) is the interface that delivers messages upon status changes to existing events.
- The Trouble Ticket Interface (TTI) facilitates the help desk integration feature of message templates. When event messages match the conditions of templates, incident tickets may be opened automatically. The use of this API minimizes the configuration of the SCAuto for OMU adapter and allows the user to configure OMU. This creates an extension to make OMU interact with ServiceCenter automatically.

The MSI and the TTI function in a similar way. By registering with OMU at these APIs, new events received by OMU are output to SCAuto for OMU. This allows ServiceCenter to open new tickets. Subsequent actions against the event message (such as annotation or acknowledgment of the event) are output to SCAuto for OMU through the MEI API.

Individual APIs are used for individual data message exchange, but the combination of two separate APIs is used throughout the duration of the data exchange. Of the combinations, the TTI & MEI integration is preferred, and the MSI & MEI integration is also valid.

The following figure shows the architectural block diagram of the integration and the adapter.

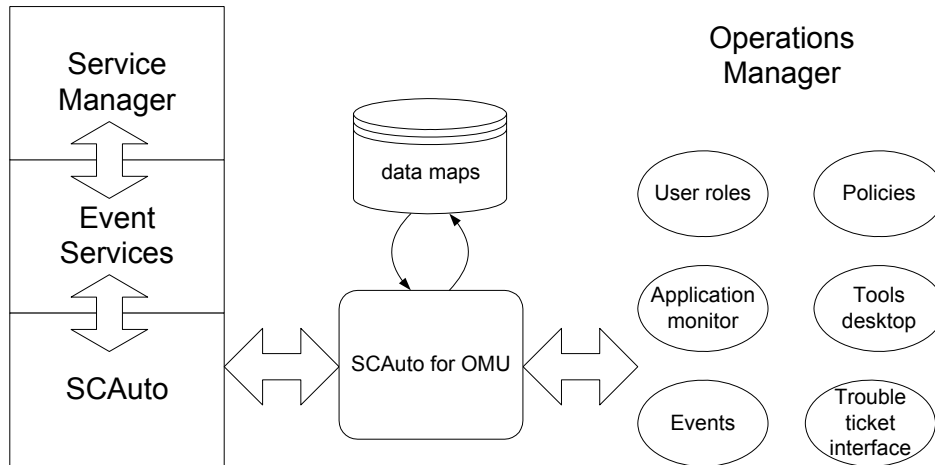

The following figure shows the modular components of SCAuto for OMU in a functional block diagram.

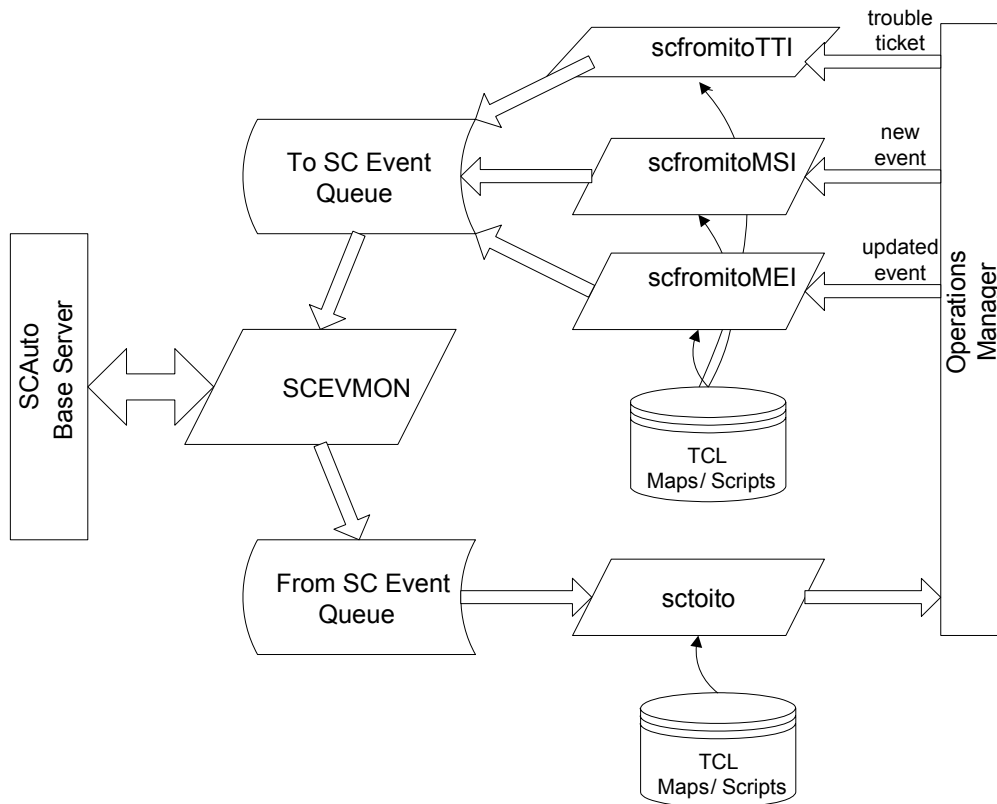

In addition to the programmatic connections, other components within OMU are configured by the installation of SCAuto for OMU. For example, a ServiceCenter message group is configured to provide a preconfigured view of the event messages delivered by ServiceCenter to OMU. Upon installation, the function is available for selection and activation without any configuration or customization required.

SCAuto for OMU also uses components that are a part of the standard SCAuto Software Development Kit (SDK). Key modules from the SDK are the event monitor (scevmon), the bi-directional event queues (ToSC and FromSC), and the event maps that formulate the conversion of incoming or outgoing messages.

Operational Concepts

The background of the static components was discussed previously. This section discusses the dynamic nature of the integration, which is a critical part of understanding the overall integration.

OMU is essentially a real-time management tool, while ServiceCenter delivers a process-oriented framework for operations. The synthesis of these domains is a dynamic environment where events and state changes drive procedure and process, and vice versa. This synthesis offers dramatic benefits for the customers of ServiceCenter and OMU.

For more information about integration, see [Chapter 4, Product Architecture](#).

Bi-directional Integration

The default mode of SCAuto for OMU operation is the bi-directional integration of ServiceCenter and OMU. In this mode, OMU events trigger ServiceCenter processes. By default, selected events automatically open incident tickets. Subsequent actions or event messages at OMU may update or close the tickets, or a similar exchange may occur from ServiceCenter into OMU.

Because most ServiceCenter applications can accept and generate event messages, this same operational flow can be applied to these ServiceCenter applications as well. This default mode of operation can be configured to meet specific end user requirements. The section [Planning Your ServiceCenter and OMU Integration](#) on [Planning Your ServiceCenter and OMU Integration](#) describes the modes of operation that can be derived from the default.

All event messages that are exchanged between ServiceCenter and OMU must be converted from their native format into a format compatible with the destination. Event messages sent to ServiceCenter must be formatted in the event message structure defined by the SCAuto SDK. SCAuto for OMU performs most of this formatting, but it relies upon ASCII text map files to specify how to convert specific OMU event message data fields into ServiceCenter event message data fields. A similar process is used for converting outbound event messages from ServiceCenter to OMU.

The adapter may create one-to-many relationships of OMU events to incoming SC event messages. This functionality is facilitated by the input maps that use the TCL scripting language. With this feature, for example, an SNMP Node Down event message can do any of the following:

- Open an incident ticket.
- Update a Configuration Management record.
- Start an SLA outage metric against a logical item, such as a database that runs on the node and is reported as down. (This is only available for installations with Service Level Management.)

The following figure shows a one OMU Event Message to Many ServiceCenter (SC) Event Messages.

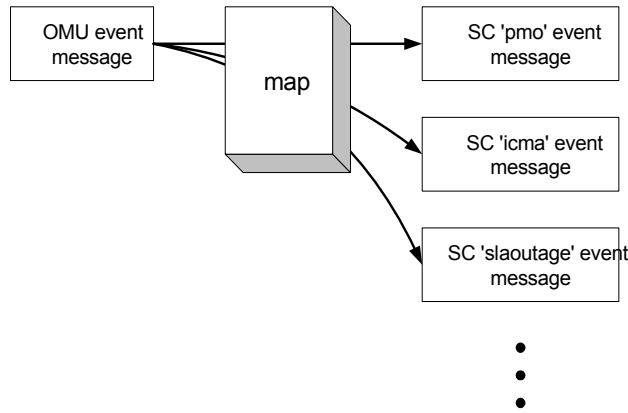

The adapter can also create one-to-many relationships of outgoing ServiceCenter events to OMU event messages or other actions. This output functionality is also supported by the use of TCL scripting language in the output maps. Since the maps are really script programs built to massage data fields, they can be edited easily to cause any desired actions.

The typical event message relationship will be one OMU event message to one ServiceCenter event message. Furthermore, many ServiceCenter event messages will be used to alter the state and the data of just one ServiceCenter incident ticket. For example, a OMU event message will create a ServiceCenter event message that will open an incident ticket. Then another OMU event message creates an update request type of ServiceCenter event message that adds new information to the original incident ticket. Then a final OMU event message will create a close request that ends the active life of the ticket.

The following figure shows One-to-One Event Message Relationships, with Many Event Messages Linked to Just One Incident Ticket.

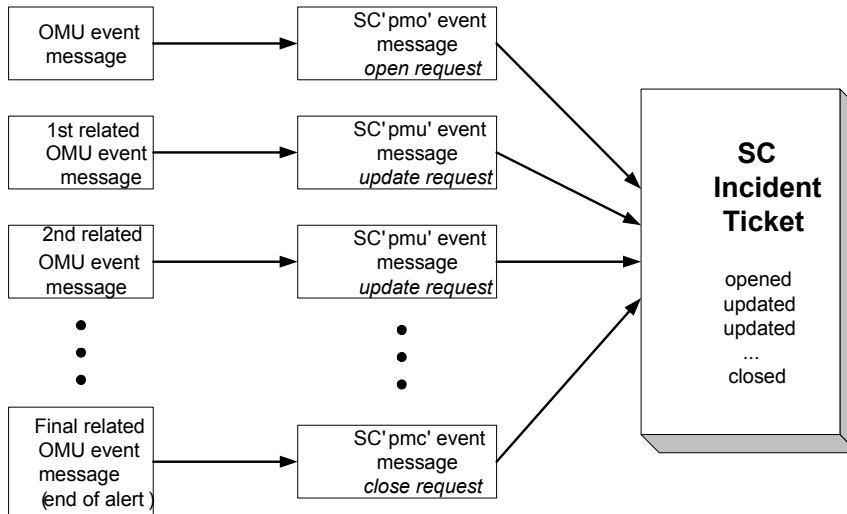

Planning Your ServiceCenter and OMU Integration

The following sections describe some of the ways in which SCAuto for OMU can be used. These scenarios help you plan and design your own implementation of OMU integrated with ServiceCenter using SCAuto for OMU. Any mode, combination of modes, or all modes can be used in a single deployment of SCAuto for OMU. Furthermore, an end user can extend the product to implement unique operational processes not described in any of the following mode sections.

For more scenarios, see [Chapter 6, Scenarios](#).

Mode 1: Uni-directional Automatic Notification from OMU

In this mode, OMU events drive ServiceCenter incident tickets. To understand this mode, you should assume that:

- Business logic is applied to the OMU event console to select which events are to be forwarded to ServiceCenter (see [OMU Business Logic Topics](#)).
- The only relationship between OMU and ServiceCenter consists of automatic tickets from OMU events. Operationally, this implies that the monitored systems and resources are proactively creating tickets when conditions are met. However, it also means that all actions on resolving the issue, fault or incident are coordinated and administered from ServiceCenter.
- The OMU event console becomes a “lights out” processing engine that feeds the service desk with intelligent real-time data, and then both expects and receives no further information or integration of service processes.

Process and Data Flow

This mode follows a process and data flow as shown in the following two flowchart diagrams.

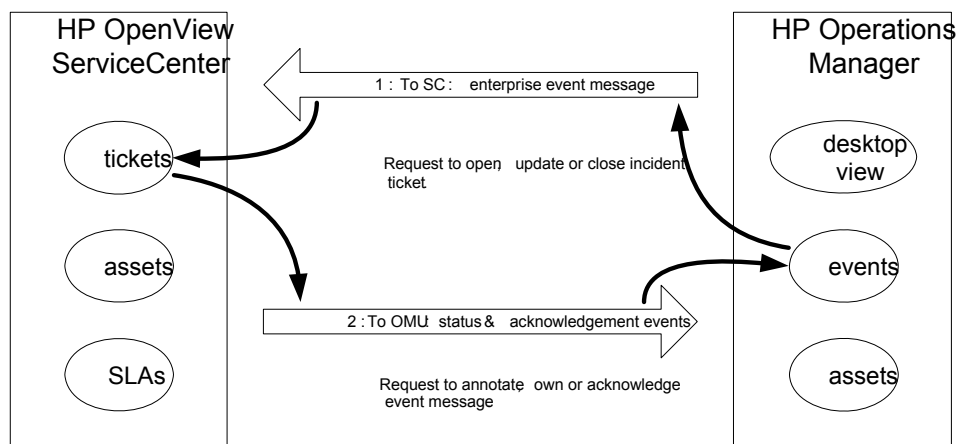

This mode is configured through the registered connection from OMU to ServiceCenter via the MSI API. This mode will invoke the following components of SCAuto for OMU:

- scfromitoMSI and scevmon processes
- ToSC Queue

- Event Maps (event.ini, and maps referenced in event.ini)

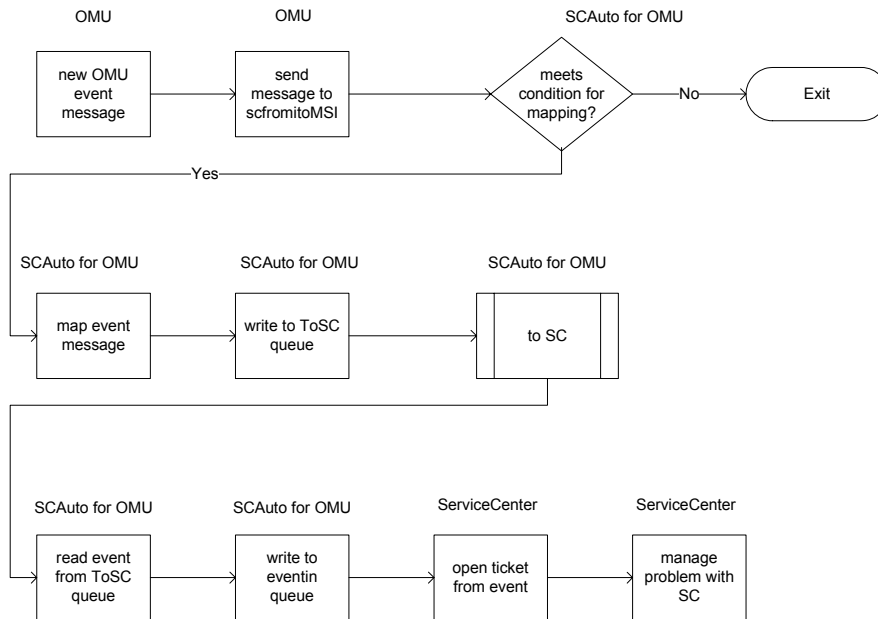

Mode 2: Bi-directional Exchange (Default Mode of Operation)

In this mode, OMU events drive ServiceCenter tickets (records), and the ServiceCenter tickets control OMU events. This creates a partnership of managing the events, where each application has a significant contribution to the event and incident management process.

This mode incorporates Mode 1, but it extends it by generating ServiceCenter events that are sent to OMU. From this bi-directional interface, there are multiple scenarios based upon state transitions and the path of service processing. For example, there are three actions on OMU events that are able to be taken (via specific event messages): annotate, acknowledge, or own. There are many more actions that can be taken on tickets, but the various instances always represent a generalized open, update, or close action on the ticket.

This mode of application partnership is the typical operational mode. It offers service desk functions to extend and enhance the real-time event management of OMU. It moves the service desk into more proactive fault management, allowing service desk analysts to respond to emerging issues, rather than reacting to fully developed faults.

This mode allows a richer protocol of integration. In effect, OMU may request the opening of tickets. In response, ServiceCenter acknowledges the open ticket and annotates the OMU event. Subsequent exchanges may inform the applications of changes in state and data values. This mode also supports a complete cycle of interaction in which a close ticket closes (acknowledges) an OMU event, and vice versa. Building this type of interaction involves business logic in both ServiceCenter and OMU.

Process and Data Flow

This mode follows a process and data flow as shown in the following two flowchart diagrams.

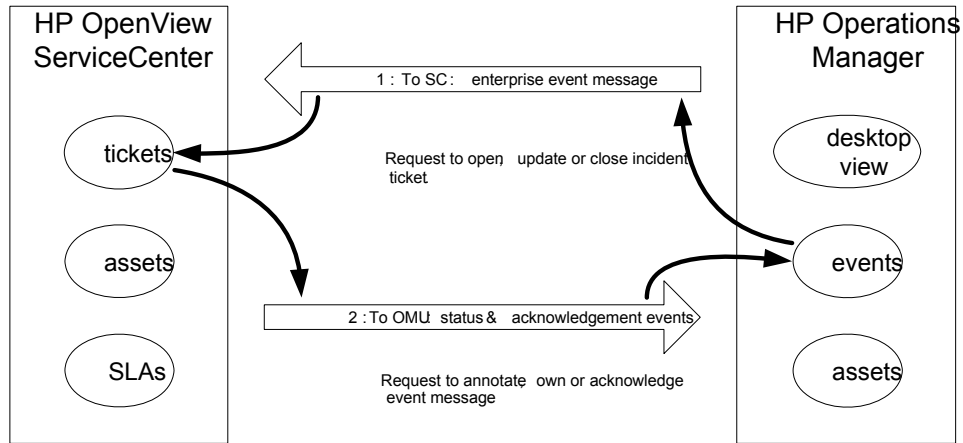

This mode is constructed through the registered connection from OMU to ServiceCenter via the MSI API, as well as the MEI API. This mode will invoke the following components of SCAuto for OMU:

- scfromitoMSI, scfromitoMEI, sctoito and scevmon processes
- ToSC and FromSC Queues
- Event Maps (event.ini, and maps referenced in event.ini)

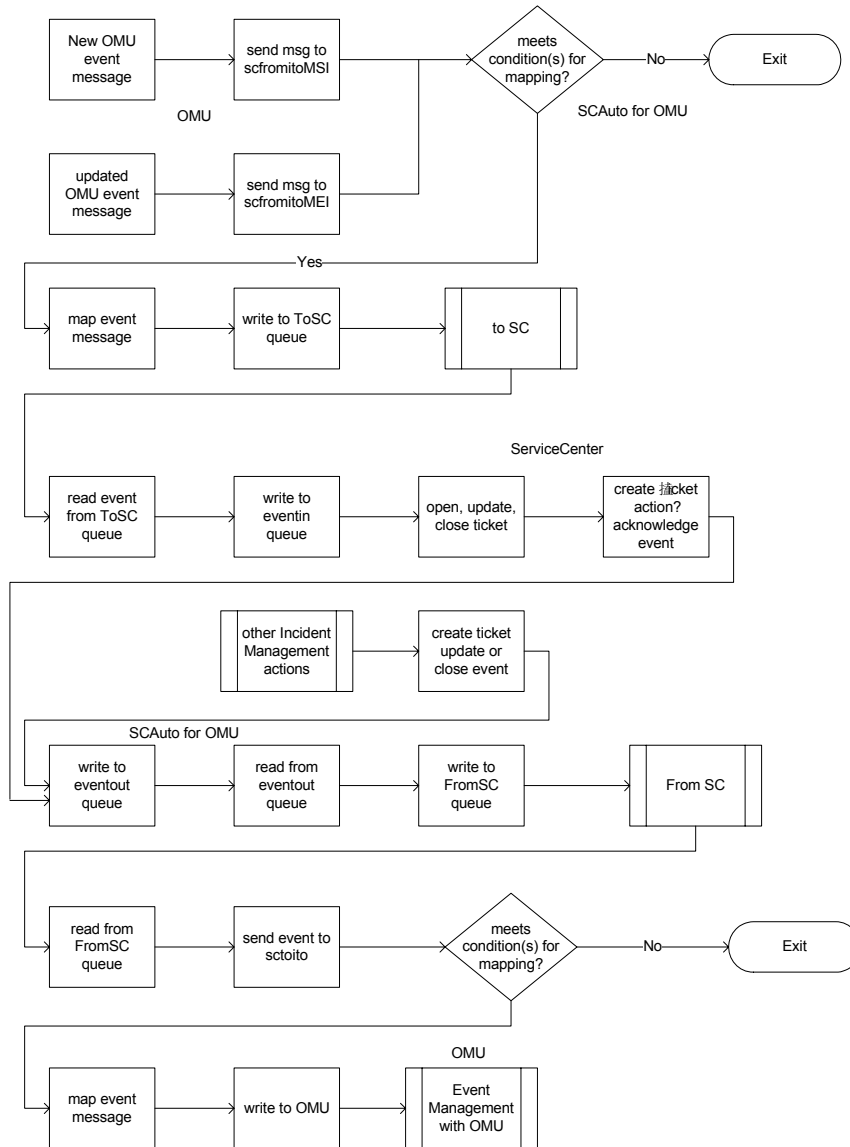

Mode 3: Automatic Notification from OMU via Trouble Ticket Interface (TTI)

This mode is an alternative configuration of Mode 1 (uni-directional) or Mode 2 (bi-directional). It uses the OMU TTI API as opposed to the MSI API. This allows for a more focused configuration of OMU Message Source Templates, freeing the MSI API to be used for other integration efforts, as well as avoiding the more complicated template formatting required with MSI configuration. With this mode, the MEI usage is identical to the previous modes.

This mode invokes the following components of SCAuto for OMU:

- scfromitoTTI, scfromitoMEI, sctoito and scevmon processes
- ToSC and FromSC Queues
- Event Maps (event.ini, and maps referenced in event.ini)

This mode uses the identical flowcharts shown earlier for Modes 1 and 2. The only difference is that references to scfromitoMSI are replaced with scfromitoTTI.

Mode 4: New ServiceCenter Tickets Generate OMU Events

This mode treats ServiceCenter as an event source or event generator. Through the application of ServiceCenter business logic, new incident tickets activate logic, which generates event messages that are sent to OMU. OMU Message Source Templates can be configured to treat these events like any other systems or network management events handled at the OMU console.

This mode begins like Mode 1, but reverses the direction of the first event message. Subsequent interaction looks exactly like Mode 2. In operation, Mode 4 would allow an OMU-centric model of service desk and enterprise management interaction. If desired, this would allow OMU to track certain ServiceCenter actions, as if they were SNMP traps, systems administration events, or any other typical OMU managed messages.

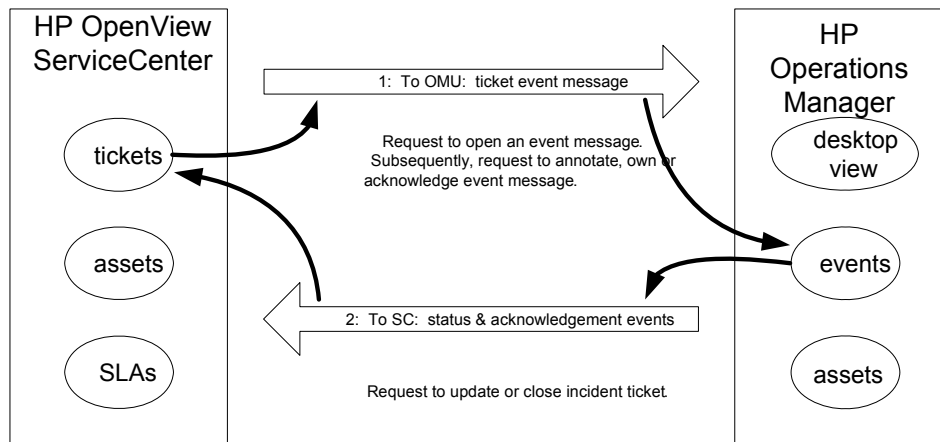

Mode 5: Application Monitoring — OMU Monitors ServiceCenter

This mode of operation acknowledges that a primary use of OMU is to monitor and manage computer applications. Upon installation of SCAuto for OMU, additional monitoring configuration functions are installed into the OMU Application Bank. These functions leverage the Application Response Measurement (ARM) specifications to offer consistent, standardized treatment of ServiceCenter. This mode also contains Message Source Templates, which allow OMU to be configured to generate events about the health of SCAuto for OMU and about the health of ServiceCenter itself. Further configuration of the Message Source Templates allows these events to become automatically generated incident tickets within ServiceCenter.

Mode 6: Combined User Interface — Launch ServiceCenter from OMU Windows (for OMU 8 Only)

To facilitate greater ease of use, SCAuto for OMU features several options for accessing ServiceCenter (6.1 or later) through a web browser directly from OMU. From the OMU root window, an icon launches a web browser using the url for the ServiceCenter web tier to open directly to the main menu. The function of this icon is also available from a pull-down menu on the root window.

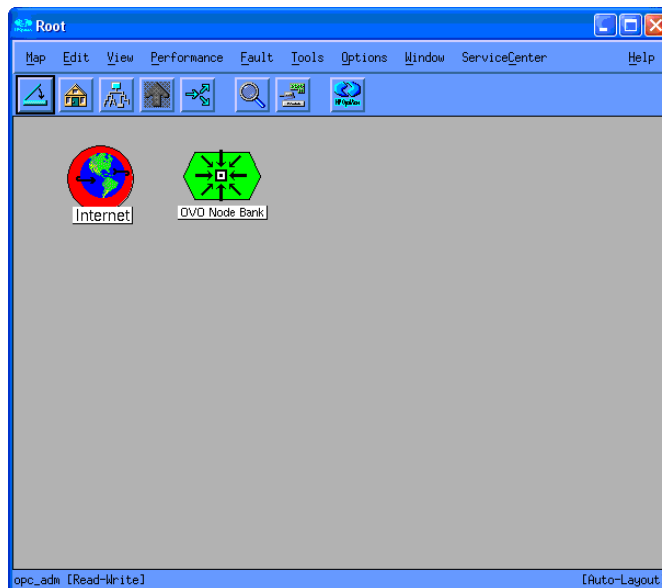

In addition to the root window, the OMU Node Bank window has a similar menu and icon to launch a connection to ServiceCenter to display specific ServiceCenter windows. In the node bank, it is possible to select a node and connect to the ServiceCenter web tier to view ServiceCenter data on the selected node. For example, this menu item lists incidents on the node.

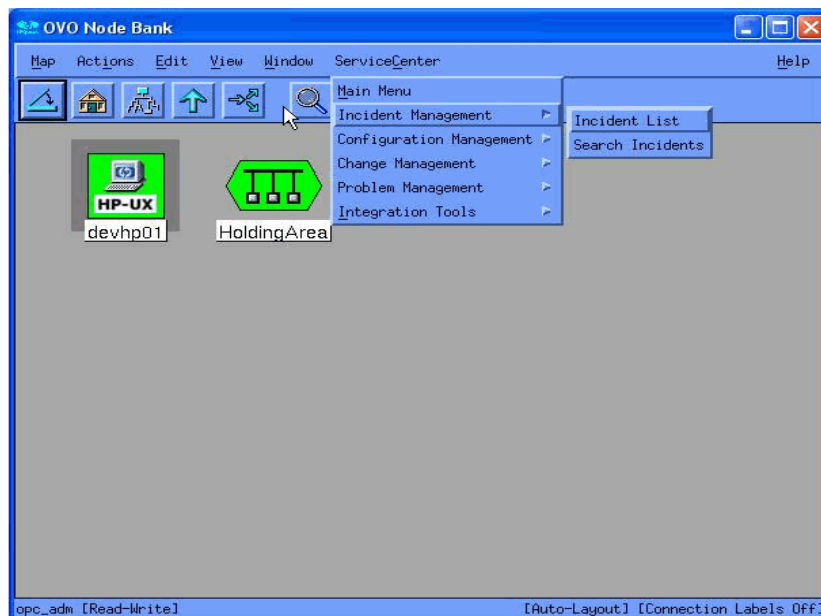

OMU Business Logic Topics

OMU automates repetitive tasks; it also enhances and supports operational processes through the tools of OMU. These benefits can be applied broadly because OMU has the ability to adapt to specific needs. This adaptability comes from OMU flexible approach to operations support. It results in an efficient way of collecting the logic of operations and the logic of running a business and using this business logic in repeatable, sustainable ways.

OMU captures business logic within its operational tools. For example, if an IT department must scrutinize user login attempts for security reasons, OMU can automate the process of such monitoring, and it can also automate the response to unusual conditions. The business logic is stored in Message Source Templates. These templates begin with expected enterprise events, and they configure the OMU processing engines to consistently respond to the events.

Message Source Templates have a wide variety of configuration parameters. Some configuration parameters condition and massage the data of the event messages. Other parameters specify actions and tasks to perform in response to received event messages. These are generic examples of programming business logic into an OMU environment. SCAuto for OMU relies on specific configuration of the templates to invoke application programming interfaces.

In a basic sense, OMU assumes that all events from all sources are potential candidates for integration with a help desk. OMU creates an API called the Trouble Ticket Interface (TTI) API for this purpose. Message Source Templates offer an option button to select this integration function, which automatically sends event messages to all applications that are registered and listening to the TTI API.

An advanced configuration of Message Source Templates is also available. Under these advanced options, you can specify that event messages from specific sources extend themselves to the Message Stream Interface (MSI) API. You can also select whether this is activated at the server or at the agent. When this option is selected, all event messages from the message source are copied to all applications that are registered and listening to the MSI API.

SCAuto for OMU leverages the above API configuration options to invoke its programs. This amounts to a business logic decision of when events of this type occur, invoke the service desk. This logic, in conjunction with the generic OMU configuration options (which capture filtering, data massage, and event message routing business logic), offers the OMU resident component capability of synthesizing the service desk with the enterprise systems management console.

ServiceCenter Business Logic Topics

ServiceCenter facilitates and automates the process of supporting business operations. Much like OMU, these benefits can be applied broadly because of ServiceCenter's flexibility and adaptability to address specific needs. Like OMU, this reflects ServiceCenter's ability to capture business logic within its applications.

ServiceCenter provides a significant amount of generic business logic within the service desk applications. The Incident Management application, for example, follows a well-defined help desk model of incident identification, tracking, and resolution. It can be used as is, or it can be customized to address specific organizational requirements. Custom business logic is most often applied to the escalation and notification aspects of the process model, although the process workflow is also frequently altered.

Business logic in ServiceCenter can be associated with several levels of ServiceCenter:

- At the bottom level are the ServiceCenter databases, where trigger mechanisms can dictate custom actions.
- Above the database level is a utilities level, which is composed of Schedules, Format Control, Macros, and Links. These tools offer the preferred location for applying custom business logic. All of the tools were designed to support this function. The ServiceCenter Event Services module essentially connects with ServiceCenter at the utilities level. This module provides equivalent functions related to processing incoming and outgoing event messages.
- The final level where business logic can be defined is at the ServiceCenter applications. This level either lends itself to easy customization of the user presentation of application data (via Forms Designer), or it involves more significant alterations that require a programming solution (via ServiceCenter's fourth generation language, RAD).

ServiceCenter Applications	
Forms	Workflow (RAD Applications)

SC Event Services	
Input Queue	Event Registration
	Event Mapping
Output Queue	Event Filtering

SC Utilities	
Database	Format Control
	Macros
	Links
	Scheduler

SCAuto for OMU utilizes the ServiceCenter Event Services module for its business logic integration with ServiceCenter. It leverages default configurations of event messages to open, update, or close an incident ticket. These event message requests are defined as event types of pmo, pmu, or pmc, respectively. The processing logic of these requests can be altered if needed, but the default configuration is satisfactory for integration with OMU.

Comparable to OMU's business logic decision of when events of this type occur, invoke the service desk, the SC Event Services response is when the service desk is invoked, receive and process the data, and then launch the appropriate service desk function. This logic is often

combined with Format Control utility logic, which injects programmed queries, tests, and automated actions into the application layer (and therefore into process model of the service desk).

This configuration of utility level business logic offers the ServiceCenter resident component of synthesizing the service desk with the enterprise systems management console. When combined with the OMU portion, the result is an extremely powerful integration that facilitates more effective and efficient IT operations and the operations of the business as a whole.

SCAuto for OMU Business Logic Topics

The previous two sections discussed capturing your business requirements in the configuration of OMU or ServiceCenter. As you define how your consolidated service desk functions, you will undoubtedly use the topics of the last two sections. However, when deploying such an enterprise solution, you may also need to put business logic into the middleware represented by SCAuto for OMU.

Other sections of this document discuss the features of this product that allow it to be customized and configured. Any of these features are sufficient for beginning to program business logic into the product. Realistically, any custom logic will be coded into the TCL scripts used for the data maps. Business logic captured in the map scripts will be able to affect many aspects of the overall integration: unique data items, selection of particular event messages, or creating many events from one input event. Regardless, see the earlier sections for more details on SCAuto for OMU's abilities of capturing business logic.

In today's business world, companies rely upon their IT resources. HP OpenView and ServiceCenter deliver the IT support that companies count on. The SCAuto for OMU product integrates these major applications, and creates a synthesis of real-time management and process oriented service delivery. Because of the natural dynamic nature of IT, there are constantly new challenges to be addressed in IT management. This new product helps address those challenges directly, and enables enterprise solutions built from the mature concepts of the consolidated service desk.

2 Installation

This chapter gives the requirements for installing SCAuto for Operations Manager for Unix (OMU) and provides step by step installation instructions.

System Requirements

To use SCAuto for OMU, your installation must be on a UNIX platform and must include the following:

- ServiceCenter version 5.1 or later
- Client launch only supported with ServiceCenter 6.1 or later
- OMU 8.20 or above, or OMU 9 on HP-UX 11.23 Itanium
- OMU 8.10 or above, or OMU 9 on Solaris 9
- OMU 9 on Linux 64
- 35 MB temporary unpack space
- 35 MB installed footprint

The ServiceCenter server can run on Windows, UNIX, or Linux. SCAuto for OMU presently runs exclusively on the UNIX platform.

OMU should be implemented and operational to the extent that meaningful events arrive at the Event Message browser, and at least one designated individual is familiar with the OMU product as well as defining OMU Event Message sources and OMU Message Actions.

SCAuto for OMU supports ServiceCenter 5.1 or later. By default, SCAuto for OMU is designed to work with the default ServiceCenter configurations. If ServiceCenter is tailored, you may also have to tailor SCAuto for OMU.

Customers with heavily customized or older systems should give consideration to use of Professional Services to implement SCAuto products.

Required Kernel Parameters

Your HP-UX or Solaris machine must have the following kernel parameter settings:

- The minimum value of any semaphore must be greater than or equal to 1 (SEMVMX).
- The maximum number of semaphore sets systemwide must be increased by 3 (SEMMNI).
- The maximum number of semaphores systemwide must be increased by 3 (SEMMNS).
- The minimum number of semaphores per semaphore set must be greater than or equal to 1 (SEMMSL).

- The maximum number of undo structures systemwide must be increased by 3 (SEMMNU).
- The minimum number of undo entries per undo structure must be greater than or equal to 1 (SEMUME).
- The minimum number of operations per semop must be greater than or equal to 1 (SEMOPM).

Installation Requirements

To install SCAuto for OMU, you must have administrator-level access both to the OMU server and the ServiceCenter server. Installation takes only a few minutes if you have determined the correct host name and port number values beforehand.

Before you begin installation, you need the following information about your OMU and ServiceCenter installations:

- Administrator authority at the OMU server
- Administrator-level access to the ServiceCenter server
- An authorization code for ServiceCenter
- The host name or IP address of the ServiceCenter server and the TCP port number for use by ServiceCenter and the SCAuto Base Server.
- Web tier host name and port number for the GUI (only for OMU 8).

Installing SCAuto for OMU

There are two major parts of the installation process:

- The Event Integration binaries and support files.
- The GUI Integration components, which can be broken down into:
 - ServiceCenter Message Group object and Application Group Objects

During installation, these parts will be configured with the customer's options and settings.

The deliverable image is available as a download or on a CD-ROM (ISO9660 format). The installation begins by executing the `install.sh` script. Installation includes these steps:

- 1 Mount the CD.
 - On HP-UX use the command `mount -o cdcase or pfs_mount`.
 - On Solaris the CD is mounted automatically.
- 2 Go to the appropriate directory. The directory name is:
 - `hp_11_ia64` for HP-UX 11.23 Itanium
 - `solaris` for Solaris 9
 - `linux` for Linux 64.
- 3 Execute `install.sh`.

Install Procedure

Important: The installation must be done as the root user.

The installation process consists of two scripts: `install.sh` and `config/install2.sh` in `scito.tar`. Executing `install.sh` unpacks `scito.tar` into a directory and then executes `config/install2.sh`. Interactive prompts enable you to stop the installation at any time. During this process, files are placed into a directory for potential manual installation. Note that stopping the installation is not recommended.

Provide the following information when prompted:

- Root directory of OMU (for example, `/opt/OV`).
- Target directory for product installation. (for example, `/opt/OV/scauto`).
- The ServiceCenter server host name and port number.
- The ServiceCenter web tier host name and port number.
- The OMU user name which is used to connect to the OMU Management Server. The default value is `opc_adm`.
- The password of the OMU user. The default value, `USE_ETC_PASSWD`, will suppress the password check for this user.



For ServiceCenter 6.1 or later, the ServiceCenter web tier information is required only if you want ServiceCenter Client GUI integration.

The installation script then takes you through the following steps:

- 1 Prompt for root directory of OMU.
- 2 Prompt for the target directory for installation, and it copies Event Maps and binaries over.
- 3 Create and configure `/etc/scauto/SCITO.init` file with the home directory of product.
- 4 Configure product ini file `scito.ini` with ServiceCenter Server information.
- 5 Configure and install HP Software Control Registration with product start/stop information.
- 6 Configure and add Menu/Toolbar GUI customizations to user `opc_adm` and `opc_op`. (Optional, for OMU 8 only)
- 7 Create ServiceCenter Message Group Object in Message Group Bank and Application Object in Application Bank. (Optional)



The “ServiceCenter Tools” Tool Group contains these Tools: Start SCITO Adapters, Stop SCITO Adapters, SCITO Adapters Status and Open Incident.

The “SCAuto_ITO” Policy Group containing these Policies: SCITO, Scevmon, ScfromitoMEI, ScfromitoMSI, and Sctoito.

If you encounter a problem that you are unable to resolve, please contact Customer Support.

Uninstalling SCAuto for OMU

To uninstall SCAuto for OMU, execute `deinstall.sh` in the installation media. You will be prompted to provide the following information:

- Root directory of OMU. (for example, /opt/OV).
- Installation directory for the product. (for example, /opt/OV/scauto).
- Options to remove configuration files, binaries, log files and so on.

After running the uninstall script, you should manually remove the Message Group, Tool Group, Tools, Policy Group and Policies added by the product at the time of installation. You can remove these items through the Administration UI.

3 Basic Operations

Starting and Stopping SCAuto for OMU Processes

The SCAuto for Operations Manager for Unix (OMU) applications are installed into OMU from HP Software Control registration files. This means that you can start and stop the processes using the HP `ovc` facility. The SCAuto for OMU processes consists of the event monitor (`scevmon`), ServiceCenter to OMU adapter (`sctoito`), and the OMU to ServiceCenter adapters (`scfromitoMEI`, `scfromitoMSI`, and `scfromitoTTI`).

Starting SCAuto for OMU

There are several ways to start the SCAuto for OMU adapter processes:

- If you chose the GUI integration during installation of SCAuto for OMU, you can start all processes by selecting **ServiceCenter > Integration Tools > Start All Adapters** from the menu on the OMU Root Window or the OMU Node Bank Window (only for OMU 8).
- You can use the OMU command line `ovc` with the `-start` parameter to start individual processes. For example, use `ovc -start scevmon` to start the `scevmon` process and `ovc -start scevmon scfromitoMSI` to start the `scevmon` and `scfromitoMSI` processes.
- In OMU 8, you can start SCAuto processes from the OMU Application Bank window through ServiceCenter Tools.

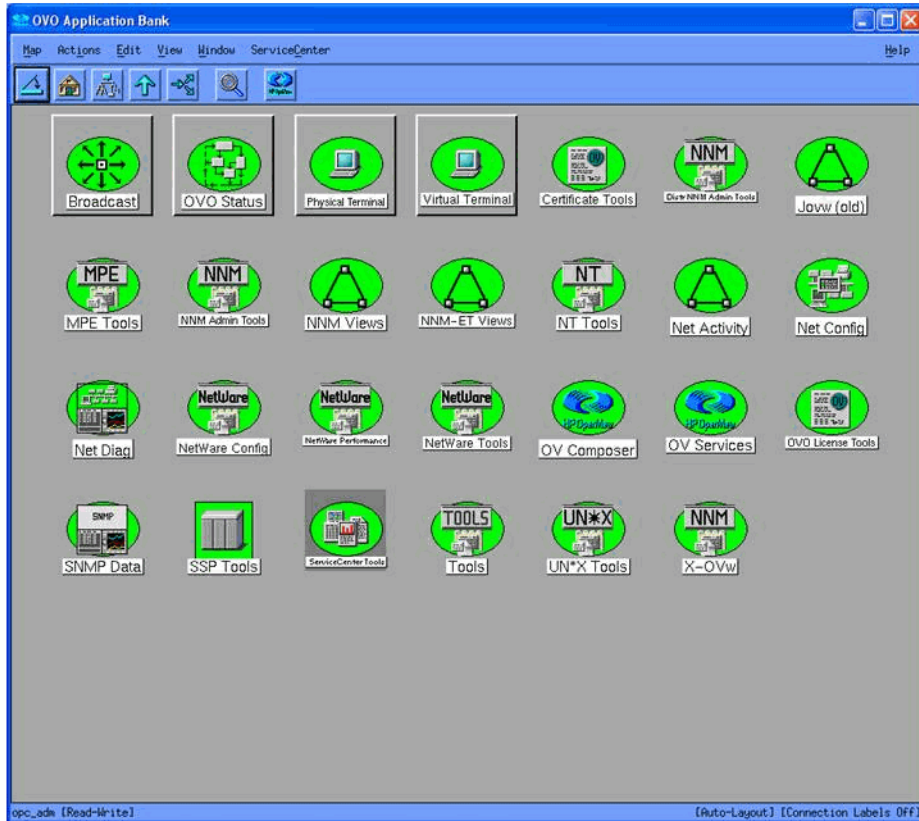

Select the **ServiceCenter Tools** icon in the OMU Application Bank window, the ServiceCenter Tools screen opens.

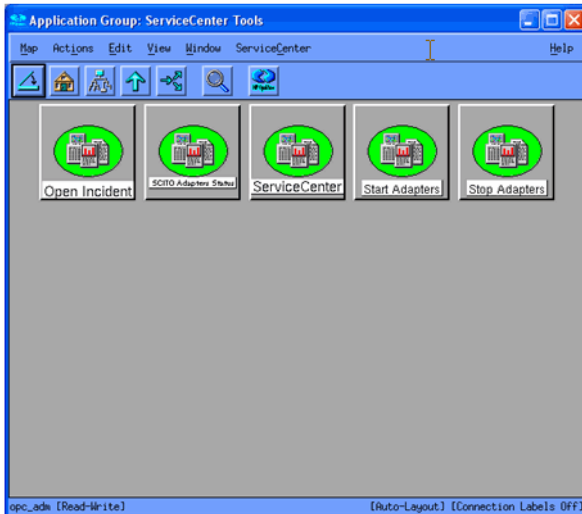

This window contains a set of icons that controls SCAuto for OMU and offers some control over ServiceCenter.

- Open Incident - allows user to open an incident ticket on selected messages in the Message Browser.
- SCITO Adapters Status - shows the operational status of the adapter processes.

- ServiceCenter - opens a connection to the ServiceCenter web tier (for ServiceCenter 6.1 or later only) if GUI integration chosen.
- Start Adapters - starts the SCAuto for OMU adapter processes.
- Stop Adapters - stops the SCAuto for OMU adapter processes.
- In OMU 9, you can start SCAuto processes in Java UI through ServiceCenter Tools.

Log in the Admin UI. In the Tool Bank page, select ServiceCenter Tools group. Select "Assign to User/Profile..." from the "Choose an action" drop-down menu to assign the tool group to an OMU user.

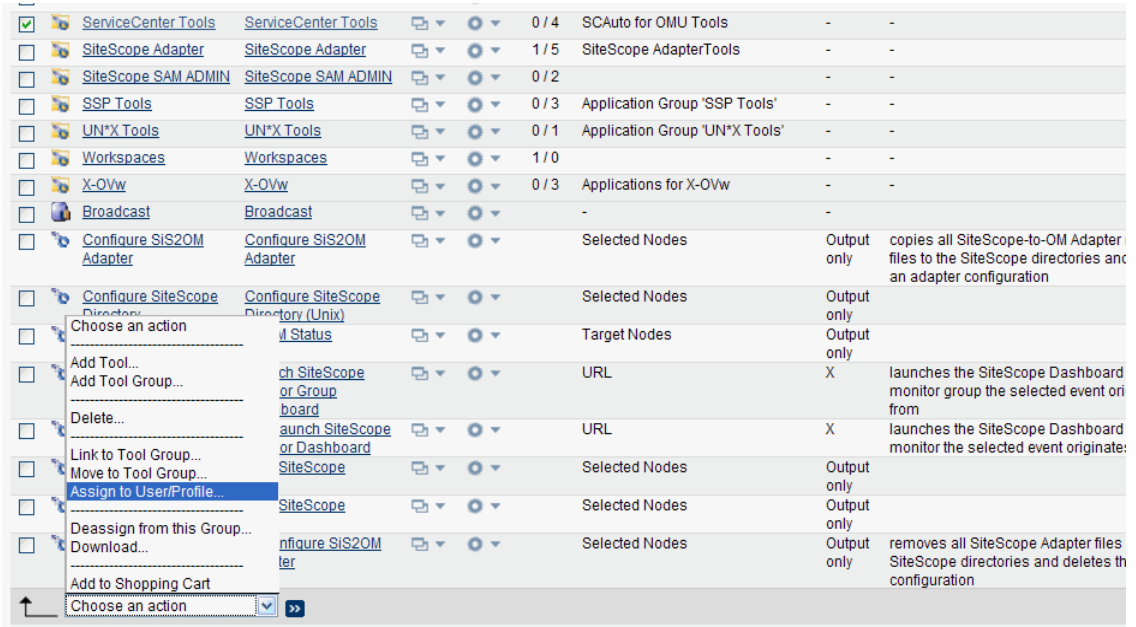

Use the user account which has been assigned to the ServiceCenter Tools group to log in Java UI, select the "Start SCITO Adapters" tool to start up SCAuto processes.

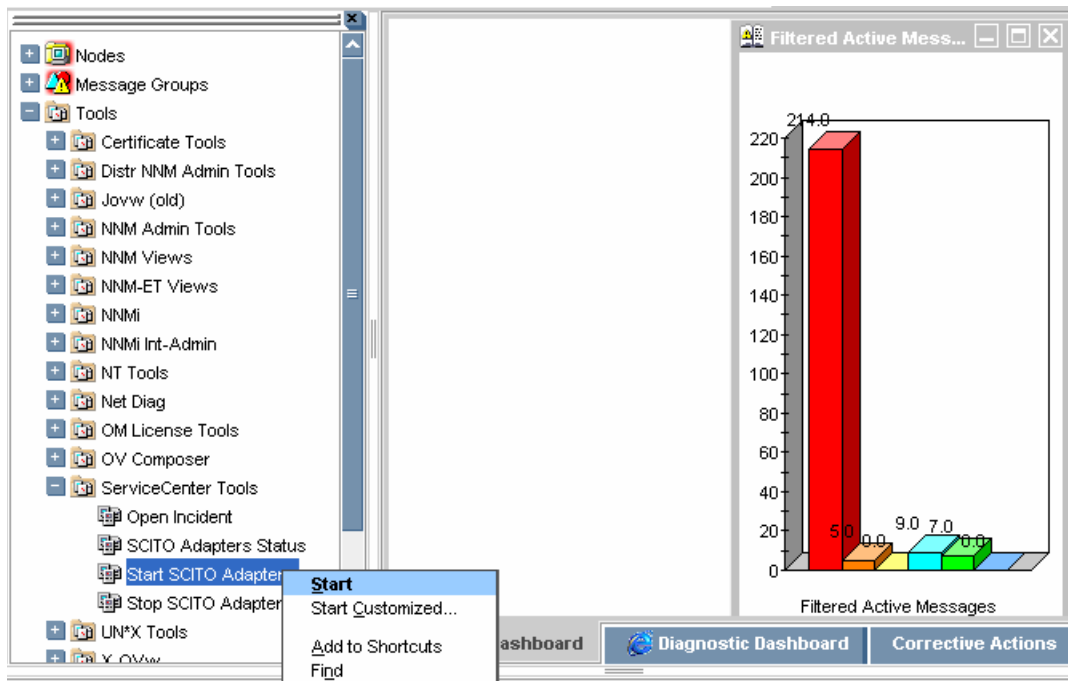

Stopping SCAuto for OMU

There are three ways to stop the SCAuto for OMU adapter processes:

- If you chose the GUI integration during installation of SCAuto for OMU, you can stop all processes by selecting the options listed below, in order, from the menu on the OMU Root Window or the OMU Node Bank Window (only for OMU 8).
- You can use the OMU command line `ovc` with the `-stop` parameter to stop individual processes. For example, use `ovc -stop scevmon` to stop the `scevmon` process and `ovc -stop scevmon scfromitoMSI` to stop the `scevmon` and `scfromitoMSI` processes.
- SCAuto for OMU can also be stopped from its icon (in the ServiceCenter Tools) in the application group Application Bank window (only for OMU 8).
- In OMU 9, you can stop SCAuto processes in Java UI through the Stop SCITO Adapters tool.

Basic Maintenance

In the product installation directory, the SCAuto for OMU adapter contains a log file called `scito.log`, as well as a parameter configuration file called `scito.ini`, where all informational and error messages from the product are stored.

The product requires very little maintenance once installed and running. By default the log file is archived to `scito.log.archive.yyyymmddhhmmss` (where `yyymmddhhmmss` is a timestamp) once it reaches 5M bytes. In addition, the event queues purge processed events to remove them once they reach 5M bytes each, retaining the unprocessed events.

scito.ini Parameters

This is a subset of the commonly used parameters that can be set in the `scito.ini` file:

- `sessid` - By default, this is set to `OPCENTER`. This is the license string for the SCAuto for OMU product. Do not modify.
- `scauto` - This is the `hostname.port` of the SCAuto server for SCAuto for OMU. This parameter is configured by the installation script.
- `event_map_dir` - This is the root directory name (starting from the installation directory) of the event mapping scripts and files. By default, it is configured as “EventMap”. It's not suggested to modify this parameter. Besides to modify the root folder name, all of the other places referring to this parameter also need to be modified.
- `log` - This is the file name for the log file. By default, it is configured as `scito.log`.
- `debugMEI :1, 2` - Set =1 turns on tracing for the `scfromitoMEI` process. Set =2 turns on more verbose tracing for the `scfromitoMEI` process.
- `debugMSI: 1, 2` - Set=1 turns on tracing for the `scfromitoMSI` process. Set =2 turns on more verbose tracing for the `scfromitoMSI` process.
- `debugTTI: 1, 2` - Set=1 turns on tracing for the `scfromitoTTI` process. Set=2 turns on more verbose tracing for the `scfromitoTTI` process.
- `debugTOITO: 1, 2` - Set=1 turns on tracing for the `sctoito` process. Set=2 turns on more verbose tracing for the `sctoito` process.

- `debugscautoevents`: - This is the SCAuto event debugging flag to output more debugging messages of the event type. Enable the parameter by setting it to 1.
- `debugscevmon`: 1,2 - Set=1 turns on tracing for the scevmon process. Set=2 turns on more verbose tracing for the scevmon process.
- `eventlogmaxlen` - This parameter defines the maximum size, in bytes, that the event queue files can reach before being purged of processed events. The default is 5M. The minimum size is 1M.
- `logmaxlen` - This parameter defines the maximum size in bytes that the log file can reach before it will be wrapped down to `logpreservelen`. The default is 5M. It is not recommended to set this value to less than 1M.
- `logpreservelen` - This parameter defines the size of the log file to wrap down to in the event it reaches `logmaxlen`. The default is 0 which causes an archive logfile to be created with a timestamp (yyyymmddhhmmss) appended to the file name when the `logmaxlen` is reached and empties the current `scito.log` file. The maximum is 128K.
- `usersepchar` - Allows user to define a separator character other than “^” (^ is the default value). To specify a different character, enter a decimal value of an ASCII character between 1 and 255.
- `scevents` - Specifies an optional list of event types which are to be retrieved from ServiceCenter's EVENTOUT queue. The default is to retrieve all types, however, this can be inefficient, because it can result in bringing over certain types of events, such as outbound page messages or email messages, which have no meaning to Operations. To restrict the types of events that are retrieved, code them in a list separated by commas and enclosed in parentheses. For example, `scevents: (pmo, pmu, pmc)`. To disable all retrieval of outbound events from ServiceCenter, use the `"noeventsfromsc:"` option.
- `noeventsfromsc` - Specifies whether or not scevmon should retrieve events from ServiceCenter's EVENTOUT queue. The default is 0 (which means events will be retrieved). To disable retrieval of all outbound events from ServiceCenter, code `"noeventsfromsc:1"`.
- `sceusers` - This parameter restricts the events which are to be retrieved from ServiceCenter's EVENTOUT queue based on the value in `evuser` field. The default is to retrieve all events regardless of the value of the `evuser` field, however, this can be inefficient, because it can result in bringing over certain events which are not intended for OMU. To use this parameter, code the values in a list separated by commas and enclosed in parentheses.

For example, `sceusers:falcon` only get events that have falcon as the `evuser`.
`sceusers:(falcon, SCITO)` only get events that have falcon or SCITO as the `evuser`.
- `scevmon_sleep_interval` - Specifies the amount of time in seconds that scevmon should sleep. The default is 5 seconds. For example, `scevmon_sleep_interval:1` tells scevmon to sleep for one second.

Basic Configuration

The SCAuto for OMU product is configured during installation. After the product is installed, it will work out of the box with the current OMU configuration. To further tailor the system to your business needs, see [Chapter 5, Configuration](#).

Troubleshooting

If incident tickets in ServiceCenter are not being created by OMU event messages, follow these steps to troubleshoot the problem:

- 1 Verify that the event monitor process `scevmon` is running. If this process is not running, execute `ovc -start scevmon` to start it.
- 2 Verify that the SCAuto for OMU event monitor is communicating with the SCAuto server. If the `scito.log` file contains the message
 - ... `scevmon : unable to connect ...`, do the following:
 - Check the `scito.ini` file for the parameter `scauto:`. Verify that it exists and points to the `<hostname>.<port number>` of the SCAuto server you are trying to connect to.
 - Log in to the ServiceCenter server host and verify that the SCAuto server is running.
 - Check the network by pinging the ServiceCenter Server host to see if it is reachable.
- 3 Verify that the `scfromitoMSI` and `scfromitoMEI` processes are currently running. If not, execute `ovc -start scfromitoMSI` and `ovc -start scfromitoMEI` to start them.
- 4 Verify that OMU event message sources are correctly set up to communicate with SCAuto for OMU. (See [Chapter 5, Configuration](#), for more details on configuring OMU message sources.)
 - If using TTI interface, verify that the event source has Trouble Ticketing enabled. Also verify that the Trouble Ticketing interface is correctly configured to use the `TTI.sh` script in the installed `scauto` directory.
 - If you are using the MSI interface, verify that the event source has Server MSI or Agent MSI message copy/divert enabled.
 - Verify that the `event.ini` configuration file in the `EventMap/ToSC` directory is properly configured.
- 5 Finally, check the `scito.log` file for any unusual error messages.

If ServiceCenter incident ticket modifications are not reaching the OMU message browser, follow these steps to troubleshoot the problem:

- 1 Verify that a record is generated in the `eventout` table in ServiceCenter. Configure format control to output equivalent records accordingly.
- 2 Check to see if the event monitor process `scevmon` is running at the OMU host. Execute `ovc -start scevmon` to start it.
- 3 Check to see if the SCAuto for OMU event monitor is communicating with the server. If the `scito.log` file contains the message ... `scevmon : unable to connect ...`, do the following:
 - Check the `scito.ini` file for the parameter `scauto:`. Verify that it exists and points to the `<hostname>.<port number>` of the SCAuto server you are trying to connect to.
 - Log in to the ServiceCenter server host and verify that the SCAuto server is running.
 - Check the network by pinging the ServiceCenter Server host to see if it is reachable.
- 4 Verify that the `sctoito` process is running using `ovc -status sctoito` on the OMU host. If it is not running, execute `ovc -start sctoito` to start it.
- 5 Check the configuration file `EventMap/FromSC/event.ini`, and verify that the user name and password are correct.

- 6 Finally, check the `scito.log` file for any unusual error messages.

4 Product Architecture

This chapter covers the architecture of HP SCAuto for Operations Manager for Unix (OMU), focusing on two primary topics:

- Application Integration
- Event Integration

Application Integration (for OMU 8 Only)

SCAuto for OMU provides an enhanced operator interface to ServiceCenter that can run under OMU. From an OMU window, you can access a number of ServiceCenter windows to gather information related to the current window or selected object.

This capability is only available if the ServiceCenter GUI interface is enabled during the SCAuto for OMU installation. If the GUI interface is not enabled, you can start a ServiceCenter client from the UNIX command line instead

➤ Refer to the appropriate ServiceCenter documentation for more information on using ServiceCenter.

ServiceCenter clients are started through the ServiceCenter menu in a OMU window. Depending upon the menu item selected, the client window will be opened to different ServiceCenter applications and windows.

All menu options are available if an icon for an object is selected in a OMU window. Specific requests requiring an object selection are grayed out if an icon is not selected.

The following windows are a tutorial representation of SCAuto for OMU general operations. Windows and functions may change from release to release, so reference the help files on your specific platform for the latest operational details.

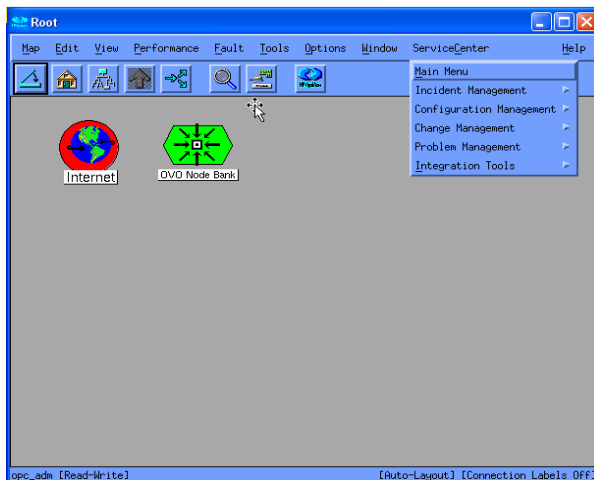

ServiceCenter Menu Options

The ServiceCenter menu options take you directly to the ServiceCenter applications from within OMU. The following sections provide a brief description of the windows.



While some of the ServiceCenter application options are mentioned in this manual, you should refer to the ServiceCenter documentation for complete instructions on using the ServiceCenter applications.

To use a ServiceCenter application under SCAuto for OMU:

- 1 Select the **ServiceCenter** menu in the OMU window and select the appropriate menu option. Some ServiceCenter menu options are not available unless an object is selected in the OMU window.
- 2 Use the mouse or keyboard to navigate through a window.
- 3 To leave the application, select the **Back** button or press F3. This takes you to the previous window or to a logout window.

Incident List

The Incident List menu option provides a list of incidents that are currently active in ServiceCenter for the selected object. When this option is selected, an incident list opens. Use the Options menu to display a list of operations to perform on the incidents. Double-click an item the incident ID to display the Incident Detail window.

Incident ID	Category	Problem Type	Severity	Status	SDU	Assignee	Brief Description
IM1005	shared infrastructure	none	2	alert stage 3	M/F SUPPORT		Cannot read information on disk. Messages of "can't read" and "can't seek"
IM1006	shared infrastructure	business applications	2	alert stage 3	SOFTWARE		Lfscan job abended with an svc99 error. Need to check into.
IM1013	network	not specified	3	alert stage 3	WAN SUPPORT		All the terminals have been frozen and non-functional for the last 2 days.
IM1014	business applications	client dependent	2	alert stage 3	PEREGRINE		System administrator deleted the operator file.
IM1016	other	none	2	open	SERVICE MANAGEMENT		All employees whose last names begin with "M" received two checks.
IM1021	shared infrastructure	business applications	2	alert stage 3	SOFTWARE		*PNMS took an A03 abend on the production system.

Update Incident Number IM1013 x

Update Incident Number IM1013

OK Cancel Previous Next Save Undo Close Find Fill Clocks

Incident ID	Open Time	Update Time	Alert Status	Category	Brief Description
IM1005	12/29/00	03/08/01	alert stage	shared	Cannot read information on disk. Messages of "can't read

Incident Number: IM1013 Ticket Status: Open

Incident Title: All the terminals have been frozen and non-functional for the last 2 days.

Incident Details Activities Contact Associated CI Attachment History Alerts Related Records Billing Information

Alert Status: alert stage 3 Owner: BOB.HELPDESK

Category: network Primary Asgn Group: WAN SUPPORT

Subcategory: wan Assignee Name:

Product Type: not specified Second Asgn Group:

Problem Type: not specified Hot Ticket: Total Loss of Service:

Manufacturer: Toshiba Severity: 3 - Medium

Class: class2 User Priority: Medium

Contact Time: Site Category: A - Critical Site

Service Contract: Cause Code: Site:

Company: PRGN Phone / extension: (619) 455-7654

Contact: FALCON, JENNIFER

Incident Description: Reported Via Self Service: Problem Management Candidate

All the terminals have been frozen and non-functional for the last 2 days.

Event Integration

SCAuto for OMU Event Integration is a collection of tools or components that is highly customizable for integrating event messages from OMU to create, update, or close a ServiceCenter incident ticket.

Event Message integration provides these capabilities:

- Ability to tap into the Message Stream Interface (MSI) for all new event messages based on event registration conditions and to create new ServiceCenter problem tickets.
- Ability to tap into the Message Event Interface (MEI) for modifications done to existing event messages based on event registration conditions, and to update or close existing ServiceCenter problem tickets.
- Provide a trouble ticketing interface from which configured OMU events may create ServiceCenter problem tickets.
- Ability to create new OMU event messages from ServiceCenter eventout output events.
- Ability to modify existing OMU event messages based on modification being done to related problem tickets in ServiceCenter using the eventout output events.
- Ability to correlate ServiceCenter problem tickets to one or more OMU event messages.
- Ability to correlate OMU event messages to a ServiceCenter incident ticket.

Integration Components

The following table shows the integration components for SCAuto.

File Name	File Type	File Description
scevmon	executable for manipulating queue files to and from ServiceCenter	This is the core technology of the SCAuto product that facilitates bi-directional queueing of messages to and from ServiceCenter.
sctoito	executable for reading the <i>from</i> queue file and forwarding to OMU	This executable functions to take an event forwarded from ServiceCenter eventout and generate/modify OMU event messages using a series of customizable TCL8.0 scripts. 80% of the OMU API library has been converted into TCL callable functions accessible by these scripts. This executable runs in the background waiting for events. The customer can do more than is provided by the OMU APIs, such as remote controlled processes.
scfromitoTTI	executable to interface with OMU Trouble Ticket Interface	Basically, OMU needs to customize interested events to forward to Trouble Ticketing first. Trouble Ticketing Interface will then call a script and pass as arguments static data describing the event. We are only interested in the first argument, which is the message ID. This executable is called once via a shell script indicated in the Trouble Ticketing custom dialog for every intended event.

File Name	File Type	File Description
sfromitoMSI	executable for writing the <i>to</i> queue from OMU Message Stream Interface	This executable will register events for the Message Stream Interface and run in the background waiting for event notification. Upon notification, it will use event maps and generate the appropriate SC events to the <i>to</i> queue. The Message Stream Interface will notify only new events in OMU.
sfromitoMEI	executable for writing the <i>to</i> queue from OMU Message Event Interface	This executable will register events for the Message Event Interface and run in the background waiting for event notification. Upon notification, it will use event maps and generate the appropriate SC events to the <i>to</i> queue. The Message Event Interface will only notify about changes done to existing events in OMU.
various map files/ TCL scripts	configuration text files	TCL scripts that are customizable for creating/modifying OMU events from ServiceCenter events as well as from OMU to ServiceCenter. Also, there are <i>ini</i> config files that need to be set up to facilitate scevmon and the locations of these files.

scevmon

This is the core of the SCAuto SDK V3. It is best described as an event message processor using *to* (ServiceCenter) and from (ServiceCenter) queue files to cache events generated by the other components. The basis of this design is to facilitate a fault recovery system that enables OMUevent messages to be queued up even while ServiceCenter is currently not available, as well as queueing up ServiceCenter events while waiting for OMU to be available. The contents of the queue files include the actual ServiceCenter events in “^” delimited format preceded by a header. These files should not be modified by hand.

The scevmon component typically runs in the background, makes a TCP connection to the SCAuto server, and waits for events to appear in the queue files. Once any of the other integration components writes an event string to the *to* queue file, scevmon picks it up, marks it as processed and forwards it to ServiceCenter's eventin table. On the other hand, if a problem ticket is modified and an entry gets created in the eventout table in ServiceCenter, scevmon picks it up, updates the sync file to point to the last entry in the eventout table, and writes the event string into the *from* queue file. At this point, the sctoito integration component picks it up, marks it as processed, and forwards it through the TCL mapping scripts to OMU.

The config files used by scevmon are:

- /etc/scauto/SCITO.init - a file that contains a variable pointing to the installed directory of the product.
- <installation directory>/scito.ini

The scevmon component reads these files:

- `$(SCITOHOM)/scevents.to.<host>.<port>` - contains ServiceCenter eventin events created by scfromito[MSI|MEI|TTI] programs. This file is updated to show processed events.
- `$(SCITOHOM)/syncfile.<host>.<port>` - synfile for the from queue with ServiceCenter eventout table.

The scevmon component writes these files:

- `$(SCITOHOM)/scito.log` - log file for informational and error messages.
- `$(SCITOHOM)/scevents.from.<host>.<port>` - contains ServiceCenter eventout events to be passed on to OMU. This file is read in by the sctoito program.
- `$(SCITOHOM)/syncfile.<host>.<port>` - synfile for the from queue with ServiceCenter eventout table.

sctoito

This is the background process that waits on the from queue, and reads in any new incoming events from ServiceCenter eventout table. It processes the event by passing it to a configurable TCL script and marks the event as processed.

This program is customized by `<installation directory>/EventMap/FromSC/event.ini` and will execute the TCL scripts pointed to by the event type names in the [EVENT] section. The [CONFIG] section is a place to specify the OMUusername and passwords to connect with. See [Chapter 5, Configuration](#), for more information about customizing the component.

The following are the components in SCAuto for OMU that read OMU messages using the Message Stream Interface or through direct OMU database APIs. They are customized by event.ini for parameters to register with the Message Stream Interface, as well as TCL scripts to execute for mapping the events to ServiceCenter event strings.

scfromitoTTI

This is the Trouble Ticket Interface adapter that can be executed using a shell script. It is the program defined for the OMU Trouble Ticketing Interface. The event source templates are customized to forward events to this application when it is running.

scfromitoMSI

This is the background process that writes to the from queue when registered OMU events appear in the Message Stream Interface.

scfromitoMEI

This is the background process that writes to the from queue when registered OMU events appear in the Message Event Interface.

These programs are customized by `$(SCITOHOM)/EventMap/ToSC/event.ini`.

5 Configuration

This chapter describes how to configure HP SCAuto for Operations Manager for Unix (OMU). It covers three main topics:

- SCAuto for OMU Business Logic Configuration
- OMU Business Logic Configuration
- ServiceCenter Business Logic Configuration

SCAuto for OMU Business Logic Configuration

This section discusses TCL language event mapping from OMU to ServiceCenter. This scripted approach to configuring the SCAuto for OMU product results in a flexible method of configuring or customizing it to meet specific business goals and requirements.

The mapping mechanism to map OMU message events into ServiceCenter incident tickets is made up of an active facility, which is a TCL script, acting on variables populated with OMU message elements to create a ServiceCenter TCL event object, using a passive facility, a static map file positionally defining each kind of interested ServiceCenter event. The send command of this ServiceCenter TCL object is then invoked to queue the event to be sent to ServiceCenter. In addition, the messages being handed to these facilities are themselves configurable to be filtered using OPCREG parameters at the interface program level using an `event.ini` configuration file.

Configuration Overview

By default, the mapping files reside in the EventMap directory in the product installation directory. The hierarchy and explanation of these files follows:

- EventMap
- EventMap/FromSC/ -- files to configure events from ServiceCenter to OMU
- EventMap/ToSC/ -- files to configure events from OMU to ServiceCenter

The following files are located in the EventMap/ToSC/ directory:

<code>event.ini</code>	Configuration file to specify MSI and MEI registration parameters to filter messages as well as which TCL map script to invoke by which application subcomponent. A detailed description will appear under the heading OMU Message Filtering The <code>event.ini</code> file.
<code>eventmapMSI.tcl</code>	The event map script for the MSI interface (<code>scfromitoMSI</code>).
<code>eventmapMEI.tcl</code>	The event map script for the MEI interface (<code>scfromitoMEI</code>).

eventmapTTI.tcl	The event map script for the TTI interface (scfromitoTTI).
pmo.map, pmu.map, pmc.map	Static map file templates used in the scripts to positionally define ServiceCenter event elements in the ServiceCenter TCL event object.
util.tcl	A utility script that contains commands to convert OMU severity values to ServiceCenter priority codes.

Basically, the `event.ini` file configures what the MSI and MEI interfaces will get from OMU and which TCL scripts to invoke when there is an OMU message. Then, the TCL scripts will use the static map files as a template to create ServiceCenter TCL event objects, populate its members, and finally send it off to the queue file to be sent to ServiceCenter eventin table.

OMU Variables

The available variables are the same as the attribute names of the `OPCDTYPE_MESSAGE`. This definition can be found in Chapter 4 of the *HP OpenView Developer's Toolkit Application Integration Guide*. These variables are made available as `TCL_GLOBAL` and will be accessible via the `$VARIABLE` syntax globally from within the called TCL script.

Variable Name	Short Definition
OPCDATA_MSGID	The unique OMU message ID.
OPCDATA_NODENAME	Name of the node producing the message. The message is only handled by the OMU manager if this system is part of the OMU Node Bank.
OPCDATA_CREATION_TIME	(Local) Time the message was created in seconds.
OPCDATA_RECEIVE_TIME	Time the message was received by the management server in seconds.
OPCDATA_MSGTYPE	Message type. This attribute is used to group messages into subgroups, e.g., to denote the occurrence of a specific incident. This information may be used by event correlation engines.
OPCDATA_GROUP	Message group.
OPCDATA_OBJECT	Object name to use for the OMU message.
OPCDATA_APPLICATION	Application which produced the message.
OPCDATA_SEVERITY	Severity of the message. Possible values are: 0 - OPC_SEV_UNCHANGED 4 - OPC_SEV_UNKNOWN 8 - OPC_SEV_NORMAL 16 - OPC_SEV_WARNING 32 - OPC_SEV_CRITICAL 64 - OPC_SEV_MINOR 128 - OPC_SEV_MAJOR

Variable Name	Short Definition
OPCDATA_AACTION_NODE	Defines the node on which the automatic action should run.
OPCDATA_AACTION_CALL	Command to use as automatic action for the OMU message.
OPCDATA_AACTION_ANNOTATE	Defines whether OMU creates start and end annotations for the automatic action. 0 - do not create annotations 1 - create annotations
OPCDATA_AACTION_ACK	Auto Acknowledge after successful execution of the Automatic Action. 0 - do not auto-acknowledge 1 - auto-acknowledge
OPCDATA_OPACTION_NODE	Defines the node on which the operator initiated action should run.
OPCDATA_OPACTION_CALL	Command to use as operator-initiated action for the OMU message.
OPCDATA_OPACTION_ANNOTATE	Define whether OMU creates start and end annotations for the operator initiated action. 0 - do not create annotations 1 - create annotations
OPCDATA_OPACTION_ACK	Auto Acknowledge after successful execution of the operator initiated action. 0 - do not auto-acknowledge 1 - auto-acknowledge
OPCDATA_MSG_LOG_ONLY	Message is Server Log Only.
OPCDATA_UNMATCHED	Defines whether or not the message matches a condition. 0 - the message was sent to the server because it matched a match condition 1 - the message did not match a match condition of the assigned templates, but was forwarded nevertheless
OPCDATA_TROUBLETICKET	Forward message to Trouble Ticket System.
OPCDATA_TROUBLETICKET_ACK	Acknowledge message after forwarding it to the Trouble Ticket System
OPCDATA_NOTIFICATION	Notification

Variable Name	Short Definition
OPCDATA_INSTR_IF_TYPE	Type of the instruction interface 0 - OPC_INSTR_NOT_SET 1 - OPC_FROM_OPC 2 - OPC_FROM_OTHER 3 - OPC_FROM_INTERNAL
OPCDATA_INSTR_IF	Name of the external instruction text interface. The external instruction text interface must be configured in OMU.
OPCDATA_INSTR_PAR	Parameters for a call to the external instruction text interface.
OPCDATA_MSGSRC	Message Source. For example, the name of the encapsulated log file if the message originated from log file encapsulation or the interface name if the message was sent via an instance of the Message Stream Interface.
OPCDATA_INSTRUCTIONS	The instructions for the message.
OPCDATA_MSGTEXT	Message Text.
OPCDATA_ORIGMSGTEXT	Original Message Text. Allows you to set additional source information for a message. It is only useful if the message text was reformatted but the OMU operator needs to have access to the original text as it appeared before formatting.
OPCDATA_ANNOTATIONS	This is not a OMU data element. It is created by the adapter product to contain a text string of all the annotations of the message.
OPCDATA_LAST_ANNOTATION	This is not a OMU data element. It is created by the adapter product to contain a text string of the last annotation of the message.

There are also three non-OPC variables added for programmability.

Variable name	Short definition
INSTALLDIR	The home directory where the product was installed.
SC_MSGTYPE	A converted message type string denoting which type of message it is. Valid values are: <ul style="list-style-type: none"> • New message • Message Owned by a user • Message Disowned by a user • Message Acknowledged • Message has new annotation(s) • All annotations of Message deleted • Automatic action of message started • Automatic action of message finished • Operator initiated action of message started • Operator initiated action of message finished
SC_PROBLEM_NUMBER	The ServiceCenter incident number embedded in the OMU Message annotation text when its a new message, or the Object of message Group ServiceCenter when its a ServiceCenter created message.

To check for the OMU Group of OS only to create a new ticket in `eventmapsMSI.tcl`, do the following:

```
....
if { $OPCDATA_GROUP != "OS" } { return }
....
```

This statement in the beginning of the script returns from the script without creating and queueing a ServiceCenter event to be sent.

ServiceCenter TCL Event Object

Legend:

<> required parameter

[] optional parameter

Summary of ServiceCenter TCL Commands

```
create_sc_event <object name>
<object name> set_evtype <event type> [ use_template <template name> ]
<object name> set_evfield <0...80>|<field name> <field value>
<object name> print
<object name> send
tcl_logprint
```

create_sc_event

```
create_sc_event <ObjectName>
```

The resultant object from this command will have methods to populate its data members and a send method to queue the event to ServiceCenter. The methods are invoked by using the newly created object name itself and therefore will have its own context. There is a limit of 10 objects that can be created in each script.

```
create_sc_event eventObject
```

The object named eventObject is created and can be used to set values and finally send it to ServiceCenter.

set_evtype

```
<ObjectName> set_evtype <evtype name> [use_template <template name>]
```

This command sets the evtype field of the event to *<evtype name>* (e.g., pmo, pmu pmc etc.). There are two optional parameters that can be specified for the event to use a Static Map File for setting the event values:

- use_template
- <template name>

If these optional parameters are not specified, setting of object fields can still be done using integer indexes, as shown in the following examples:

```
create_sc_event eventObject
# create the event object
eventObject set_evtype pmo use_template "EventMap/ToSC/pmo.map"
# make it of type pmo, and use the template for
# named indexes.
```

The event object eventObject is created. It is then set to type pmo, essentially, the evtype field of the event is set to pmo. The static map file EventMap/ToSC/pmo.map is used to define the named indexes that will be used later to set the other fields.

```
create_sc_event eventObject
# create the event object
eventObject set_evtype pmo
# set the evtype to pmo. do not use templates for indexing
```

The event object eventObject is created. It is then set to pmo for evtype. Because a template was not used here, subsequent setting of evfields will have to use integer indexes.

set_evfield

```
<ObjectName> set_evfield <0 ... 80>|<evfield name> <value>
```

This command sets the event fields with values. If the use_template option was used during the set_evtype command, then you may use field names defined in the static map file templates to set the values, otherwise, you have to use positional integer indexes to set the evfield values. See the following examples:

```
create_sc_event eObject
# create the event object
eObject set_evtype pmo
# set the evtype to "pmo". do not use templates for indexing
eObject set_evfield 1 $OPCDATA_NODENAME
```



```
# set evfield position 1 to ITO nodename variable
```

The event object is created, set to evtype “pmo” without using a static map file for template. The first field of the event object is set to the OMU variable for nodename.

```
create_sc_event eObject
# create the event object
eObject set_evtype pmo use_template "EventMap/ToSC/pmo.map"
# set the evtype
# use a templates for indexing
eObject set_evfield logical.name $OPCDATA_NODENAME
# set logical.name evfield to ITO nodename variable
```

The event object is created, set to evtype “pmo” using a static map file for template. The logical.name field of the event object is set to the OMU variable for nodename.

set_evuser

```
<ObjectName> set_evuser <value>
```

This command sets the evuser field of the event to <value>. The maximum length of <value> is 24 characters. The default value for the evuser field is SCITO. For example:

```
# create the event object
create_sc_event eventObject

# set evuser to SCITO-WEST
eventObject set_evuser "SCITO-WEST"
```

print

```
<ObjectName> print
```

This command outputs to stderr all the contents of the object including the template field names if used.

send

```
<objectName> send
```

This command queues the event object to be sent to ServiceCenter's eventin table.

For more examples on how to use the commands, see the example script file.

tcl_logprint

```
tcl_logprint "Message"
```

This command is used to write messages from the tcl script to the SCAuto for OMU log file (scito.log).

Example:

```
tcl_logprint "eventmapTTI.tcl: queueing new ticket to be opened.
($OPCDATA_MSGID)"
```

Static Map File

The static map file that is usable in a `set_evtype` command as the template is an ascii text file. Each row denotes a positional field name of the intended ServiceCenter event map starting at index 1, for example, row 1 = field 1 in event map.

By default, three maps for event types `pmo`, `pmu` and `pmc` are delivered. These maps match the ServiceCenter event maps.

Example `pmo.map` used in `eventmapMSI.tcl`.

```
----- begin file -----
logical.name
network.name
reference.no
cause.code
action
action2
action3
network.address
type
category
domain
objid
version
model
serial.no.
vendor
location
contact.name
contact.phone
resolution
assignee.name
priority.code
failing.component
system
ci.date.time
flow
server.id
system.state
units
value
port.index
severity.code
site.category
fix.type
resolution.code
subcategory
product.type
problem.type
adj.resolution.time
explanation1
class
----- end file-----
```

The map template file is not a required piece of the configuration; it is used to make it convenient and manageable to name the event fields in the ServiceCenter TCL event object. Without this file, however, you can still set the values using integer indexes.

OMU Message Filtering the event.ini File

The `event.ini` file in the `<install_dir>/EventMap/ToSC` directory is a means of configuring the `scfromitoMSI`, `scfromitoMEI` and `scfromitoTTI` components of the interface.

In the `event.ini` file, you can specify:

- How you want to filter MSI event messages
- How you want to filter MEI event messages
- Which TCL map files to execute when a message of type MSI, MEI and/or TTI is available

There are two main structures in the ini file, and this file closely follows the format of a Microsoft Windows ini file format.

Sections

Section header names are identified by enclosing them in square brackets [...]. The brackets group sets of configurable parameters. There are three required section header names:

- `MSI_CONFIG` Section for configuring the MSI interface
- `MEI_CONFIG` Section for configuring the MEI interface
- `TTI_CONFIG` Section for configuring the TTI interface

Each section header name contains its own set of required parameters.

Section name	Required parameters
MSI_CONFIG	<p>OPC_USER - This is the OMU user the MSI interface will connect as to retrieve message details.</p> <p>OPC_PASSWORD - This is the password for the OPC_USER. Optionally, you may specify the string literal USE_ETC_PASSWD in this field. This parameter suppresses the password check.</p> <p>MSI_OPCREG_MSGTYPE - This is an MSI registration attribute to filter on which OMU message type to notify. This is a String value of maximum 36 characters, no spaces. Consult your OMU Message Source Templates for available message types. If you specify the keyword "ALL" in this field, all messages copying/diverting to the Message Stream Interface will be notified.</p> <p>MSI_OPCREG_GROUP - This is an MSI registration attribute to filter on which OMU message group to notify. This is a String value of maximum 32 characters, no spaces. Consult your OMU Message Source Templates for available message groups.</p> <p>MSI_OPCREG_NODENAME - This is an MSI registration attribute to filter on which OMU node name to notify. This is a String value of maximum 254 characters, no spaces.</p> <p>MSI_OPCREG_OBJECT - This is an MSI registration attribute to filter on which OMU message object to notify. This is a String value of maximum 32 characters, no spaces. Consult your OMU Message Source Templates for available message objects.</p>

Section name	Required parameters
	<p>MSI_OPCREG_SEVERITY - This is an MSI registration attribute to filter on which OMU message severity to notify. This is a String value of 1 or more characters to denote ORing of values. Valid characters are:</p> <p>"c" - critical "w" - warning "n" - normal "u" - unknown "j" - major "m" - minor "cwj" - critical or warning or major. This is the only attribute you don't need the ' ' to denote ORing.</p> <p>MSI_OPCREG_APPLICATION - This is an MSI registration attribute to filter on which OMU message application to notify. This is a String value of maximum 32 characters, no spaces. Consult your OMU Message Source Templates for available message applications.</p> <p>POLL_INTERVAL 0 means blocking read for opcif_read call. # means number of seconds to sleep before calling non-blocking opcif_read.</p> <p>MSI_EVENTMAPS - This parameter specifies which section header to fall into, to look for the attribute "mapname" for specifying which TCL script to execute for this interface.</p> <p>Note: Values with more than one attribute implicitly assume a logical ANDing of all non-null attributes.</p> <p>Note: Within each individual attribute, use the ' ' character to logically OR more than one value.</p>
MEI_CONFIG	<p>OPC_USER - This is the OMU user the MEI interface will connect as to retrieve message details.</p> <p>OPC_PASSWORD - This is the password for the OPC_USER. Optionally, you may specify the string literal USE_ETC_PASSWD in this field. This parameter suppresses the password check.</p> <p>MEI_OPCREG_MSG_EVENT_MASK - This is an OMU Message Event Interface event mask to specify which type of change-in-message should be notified. Valid values are:</p> <ul style="list-style-type: none"> • OPC_MSG_EVENT_OWN - when a message is owned • OPC_MSG_EVENT_DISOWN - when a message is disowned • OPC_MSG_EVENT_UNACK - when a message is unacknowledged • OPC_MSG_EVENT_ACK - when a message is acknowledged • OPC_MSG_EVENT_ANNO - when a message is annotated • OPC_MSG_EVENT_NO_ANNO - when there are no annotations • POLL_INTERVAL: • 0 means blocking read for opcif_read call • # means seconds to sleep before calling non-blocking opcif_read <p>MEI_EVENTMAPS - This parameter specifies which section header to fall into, to look for the attribute "mapname" for specifying which TCL script to execute for this interface.</p> <p>Note: For MEI_OPCREG_MSG_EVENT_MASK, use the ' ' character to denote logical OR'ing of event types.</p>

Section name	Required parameters
TTI_CONFIG	<p>OPC_USER - This is the OMU user the MEI interface will connect as to retrieve message details.</p> <p>OPC_PASSWORD - This is the password for the OPC_USER. Optionally, you may specify the string literal USE_ETC_PASSWD in this field. This parameter suppresses the password check.</p> <p>TTI_EVENTMAPS - This parameter specifies which section header to fall into, to look for the attribute "mapname" for specifying which TCL script to execute for this interface.</p>

Example event.ini file:

```

----- begin file -----
[ MSI_CONFIG ]
OPC_USER=opc_adm
OPC_PASSWORD=USE_ETC_PASSWD
MSI_OPCREG_MSGTYPE=ALL
MSI_OPCREG_GROUP=
MSI_OPCREG_NODENAME=
MSI_OPCREG_OBJECT=
MSI_OPCREG_SEVERITY=
MSI_OPCREG_APPLICATION=
MSI_EVENTMAPS=MSI_EVENTMAPS
POLL_INTERVAL=0

[ MEI_CONFIG ]
OPC_USER=opc_adm
OPC_PASSWORD=USE_ETC_PASSWD
MEI_OPCREG_MSG_EVENT_MASK=OPC_MSG_EVENT_OWN|OPC_MSG_EVENT_DISOWN|OPC_MSG_
EVENT_UNACK|OPC_MSG_EVENT_ACK|
OPC_MSG_EVENT_ANNO|OPC_MSG_EVENT_NO_ANNO
MEI_EVENTMAPS=MEI_EVENTMAPS
POLL_INTERVAL=0

[ TTI_CONFIG ]
OPC_USER=opc_adm
OPC_PASSWORD=USE_ETC_PASSWD
TTI_EVENTMAPS=TTI_EVENTMAPS

[ MSI_EVENTMAPS ]
mapname=EventMap/ToSC/eventmapMSI.tcl

[ MEI_EVENTMAPS ]
mapname=EventMap/ToSC/eventmapMEI.tcl

[ TTI_EVENTMAPS ]
mapname=EventMap/ToSC/eventmapTTI.tcl

----- end file -----

```

Using TTI - Trouble Ticketing Interface

To use TTI in OMU 8:

- 1 Identify which message source you want to forward to the TTI in the Message Source Template and enable it.
- 2 In the Node Bank submap OMU, select the following menu commands, in order: **Actions > Utilities > Trouble Ticket**.
- 3 Enable the interface by clicking on the check box.
- 4 Enter in the Call of trouble ticket field `<install dir>/TTI.sh`. `<install dir>` is the SCAuto product install directory.

To use TTI in OMU 9:

- 1 Log in to Admin UI, select **Edit > Edit Trouble Ticket Interface** from the menu bar.
- 2 Select "Use Trouble Ticket System" and fill in the "Call of Trouble Ticket Interface" field with the value of `<install dir>/TTI.sh`. `<install dir>` is the SCAuto product install directory.

Default Behavior

The `scfromitoMSI` process picks up all events that copy or divert to the Message Stream Interface. If the host name of the occurring event is different, ServiceCenter creates a new incident ticket. If the host name of the occurring event is the same, the same ticket is updated by default, and a new ServiceCenter OMU event is created with a ServiceCenter Group attribute. You can use the ServiceCenter Message Group in the OMU Message Group Bank to filter the messages.

The `scfromitoMEI` process only picks up events that were previously opened as ServiceCenter incident tickets or ServiceCenter event group events if the message for the incident or event has been modified by the OMU message browser. This modification can consist of an operator owning, acknowledging, or annotating a ServiceCenter event type or a OMU event that caused a incident ticket. When this type of modification occurs, a pmu is generated to modify the same incident ticket in ServiceCenter.

Example eventmapMSI.tcl Script

```
----- begin file -----
#
# create only if its a new message from OPC
#
if { $SC_MSGTYPE != "New message" } {
    tcl_logprint "eventmapMSI.tcl: skipping event - $SC_MSGTYPE"
    return
}

#
# skip ServiceCenter events
#
if { $OPCDATA_GROUP == "ServiceCenter" } {
    tcl_logprint "eventmapMSI.tcl: skipping ServiceCenter event -
$SC_MSGTYPE"
    return
}
```

```

}

#
# skip Normal severity events
#
if { $OPCDATA_SEVERITY == "8" } {
    tcl_logprint "eventmapMSI.tcl: skipping \"Normal\" severity event -
($OPCDATA_MSGID)"
    return
}

#
# OPCDATA_CREATION_TIME processing
# save the incoming (seconds) value in new variable
# format as previous release
# create value that SC will like for a date/time field
#
set OPCDATA_CREATION_TIME_SECONDS $OPCDATA_CREATION_TIME
set OPCDATA_CREATION_TIME [clock format $OPCDATA_CREATION_TIME_SECONDS
-format "%a %b %d %T %Y"]
set OPCDATA_CREATION_TIME_SC [clock format $OPCDATA_CREATION_TIME_SECONDS
-format "%m/%d/%Y %T" -gmt true]

#
# do the same for OPCDATA_RECEIVE_TIME
#
set OPCDATA_RECEIVE_TIME_SECONDS $OPCDATA_RECEIVE_TIME
set OPCDATA_RECEIVE_TIME [clock format $OPCDATA_RECEIVE_TIME_SECONDS
-format "%a %b %d %T %Y"]
set OPCDATA_RECEIVE_TIME_SC [clock format $OPCDATA_RECEIVE_TIME_SECONDS
-format "%m/%d/%Y %T" -gmt true]

#
# create the event object
#
create_sc_event eventObject

#
#set evuser to this hostname
#
eventObject set_evuser "SCITO-[lindex [split [info hostname] .] 0]"

#
# set the event type using a template to define field names
# * if you don't use a template, you can use integer
# * indexes into the evfield array.
#
eventObject set_evtype pmo use_template "EventMap/ToSC/pmo.map"

#
# start mapping field names to OMU values
#
eventObject set_evfield logical.name $OPCDATA_NODENAME
eventObject set_evfield network.name $OPCDATA_NODENAME
eventObject set_evfield reference.no $OPCDATA_MSGID

```



```

eventObject set_evfield cause.code $OPCDATA_MSGSRC

eventObject set_evfield action [ format "%s on %s (Original message:
%s)\nInstructions:\n%s\n<ITOMSGID:%s,%s>\n" $OPCDATA_MSGTEXT
$OPCDATA_CREATION_TIME $OPCDATA_ORIGMSGTEXT $OPCDATA_INSTRUCTIONS
$OPCDATA_MSGID $SC_MSGTYPE ]

eventObject set_evfield network.address $OPCDATA_NODENAME
eventObject set_evfield type ITOEvent
eventObject set_evfield category example

#
# convert OMU severity to ServiceCenter severity code proc is defined in
util.tcl
#
source "$INSTALLDIR./EventMap/ToSC/util.tcl"
set SC_SEVERITY [ ConvertSeverity "$OPCDATA_SEVERITY" ]

eventObject set_evfield severity.code $SC_SEVERITY
eventObject set_evfield priority.code $SC_SEVERITY

eventObject set_evfield failing.component [ concat $OPCDATA_GROUP ","
$OPCDATA_OBJECT "," $OPCDATA_APPLICATION ]
eventObject set_evfield system $OPCDATA_MSGSRC

#
# print out a debug of event created
#
#eventObject print

#
# send the event to queue
#
tcl_logprint "eventmapMSI.tcl: queueing new ticket to be opened.
($OPCDATA_MSGID)"
eventObject send
----- end file -----

```

TCL Event Mapping from ServiceCenter to OMU

The mapping mechanism to map ServiceCenter events into OMU messages is done by invoking a TCL script. ServiceCenter event fields are made into TCL_GLOBAL variables that can be accessed in the targeted script with the \$VARIABLE syntax. Various OMU programming APIs are also made into TCL_Command commands callable from within the same script, thus effectively bridging the two domains.

Configuration Overview

By default, the mapping files reside in an EventMap directory within the product installation directory. The hierarchy and function of the EventMap directory structure follows:

- EventMap
- EventMap/FromSC/ - files to configure events from ServiceCenter to OMU

- EventMap/ToSC/ - files to configure events from OMU to ServiceCenter

The following files are located in the EventMap/FromSC/ directory:

event.ini	The configuration file that specifies OMU user and password, and TCL scripts to invoke based on event types.
pmo.tcl	The event map script to invoke when there is a pmo (Incident Opened).
pmu.tcl	The event map script to invoke when there is a pmu (Incident Updated).
pmc.tcl	The event map script to invoke when there is a pmc (Incident Closed).
util.tcl	Utility TCL script that contains command to convert ServiceCenter priority codes to OMU Severity values.
default.tcl	A default TCL script to invoke when an event type is received and there is no equivalent TCL script.
showEvent.tcl	A debug script that will display all event field values from a ServiceCenter event.

The event.ini file configures the OMU user name and password, along with the TCL scripts that are invoked based on the evttype field of the incoming ServiceCenter event.

ServiceCenter TCL Variables

The available variables depend on the evttype type field and are in accordance with the event maps from Events Services in ServiceCenter for that type. These variables are made available as TCL_GLOBAL and will be accessible via the \$VARIABLE syntax globally from within the called TCL script. See the Event Services User's Guide for more detail about event maps.

Variable name	Short description
INSTALLDIR	The directory path where the product was installed. This is not part of an event field and is added for convenience in locating helper scripts.
SCEVTYPE	ServiceCenter registration name for the event, for example, pmo.
SCEVTIME	Date and time event occurred.
SCEVSYSSEQ	ServiceCenter eventout queue sequence number. Used as checkpoint in sync file.
SCEVUSRSEQ	A user-assigned sequence number used to trace an event through ServiceCenter.
SCEVSYSOPT	A code to identify system options.
SCSCEVUSER	The event user name; if passed, it is used as the operator name.
SCEVPSWD	The event user's password.

Variable name	Short description
SCEVSEPCHAR	The character used to separate fields in the \$SCEVFIELDS variable. Default is "^".
SCEVFIELDS	The data describing the event, with fields separated by the \$SCEVSEPCHAR character.
SCEVFIELDS_1..2..3 ...*	The event fields from the \$SCEVFIELDS string parsed out as individual field values using the \$SCEVSEPCHAR separator value.



The specific field definition depends on the evtype coming back and is documented in the `<evtype>.tcl` scripts themselves. It is up to the user to define types that do not have a corresponding TCL script.

OMU Programming APIs as TCL Commands

LEGEND:

< > required parameter

[] optional parameter

These are OMU Programming APIs that have been wrapped in TCL commands and made available during the script invocation. Specifically, the available APIs consists of `opcif_*` types for writing to the Message Stream Interface, and `opcmsg_*` types for retrieving message details from the database.

Summary of OMU TCL Commands

- `opcif_write <Message Text> <Application> <Message Group> <Message Type> <Node Name> <Object> <Severity>`
- `opcmsg_annotation_add <Message Id> <Annotation Text>`
- `opcmsg_ack <Message Id>`
- `opcmsg_unack <Message Id>`
- `opcmsg_own <Message Id>`
- `opcmsg_disown <Message Id>`
- `opcmsg_op_action_start <Message Id>`
- `opcmsg_cma_set <Message Id> <CMA Name> <CMA Value>`
- `tcl_logprint`

opcif_write

`opcif_write <Message Text> <Application> <Message Group> <Message Type> <Node Name> <Object> <Severity>`

The `opcif_write` command creates a new OMU message. To pass a null value, use "" for an empty string instead. There are seven required arguments to this command:

Message Text	The message text of the newly created OMU message.
Application	The application that this message belongs to. Check your Message Source Templates for valid application names.
Message Group	The group that this message belongs to. Check your Message Source Templates for valid application names.
Message Type	The type that this message belongs to. Check your Message Source Templates for valid application names.
Node Name	The OMU node name that this message is created for.
Object	The object that this message belongs to. Check your Message Source Templates for valid application names.
Severity	The OMU severity value for this message. Check the utility script <code>EventMap/FromSC/util.tcl</code> for the conversion utility to convert from ServiceCenter priority codes. Valid values are: c - Critical j - Major m - Minor w - Warning n - Normal

Example:

```
# source in the util.tcl script to get the ConvertSeverity command
source "$INSTALLDIR./EventMap/FromSC/util.tcl"

# construct a formatted message text to be passed to opcif_write
set OPC_Message_Text "Incident ticket $SCEVFIELDS_2 opened on
$SCEVFIELDS_4 by $SCEVFIELDS_5 for Message ID $SCEVFIELDS_14\n Category:
$SCEVFIELDS_3\n Assigned to: $SCEVFIELDS_9\n Severity: $SCEVFIELDS_8\n
CauseCode: $SCEVFIELDS_17\n Hostname: $SCEVFIELDS_18\n Group:
$SCEVFIELDS_19\n Location: $SCEVFIELDS_21\n Action: $SCEVFIELDS_26\n
Contact: $SCEVFIELDS_32 $SCEVFIELDS_34\n NetworkName: $SCEVFIELDS_35\n
Resolution: $SCEVFIELDS_37\n UpdateAction: $SCEVFIELDS_38"

# convert ServiceCenter severity code to ITO Severity indicator
set SCSEVERITY [ ConvertSeverity "$SCEVFIELDS_8" ]

# create the new ITO message
opcif_write "$OPC_Message_Text" "ServiceCenter_pmo" "ServiceCenter"
"TroubleTicket" "$SCEVFIELDS_18" "pmo" "$SCSEVERITY"
```

In this example, a new OMU message is created with a formatted message text from ServiceCenter event fields of `Application="ServiceCenter_pmo"`, `Group="ServiceCenter"`, `Type="TroubleTicket"`, node name from ServiceCenter event `logical.name` field, `Object="pmo"` and a converted Severity that is equivalent to the ServiceCenter priority code.

opcmsg_annotation_add

```
opcmsg_annotation_add <Message Id> <Annotation Text>
```

This command adds an annotation to an existing OMU message. This command requires two arguments, consisting of a OMU message ID and free-form annotation text.

Example:

```
# pre-format an annotation text to use from ServiceCenter field values
set OPC_Annotate_Text "Incident ticket $SCEVFIELDS_2 opened on
$SCEVFIELDS_4 by $SCEVFIELDS_5\n Category: $SCEVFIELDS_3\n Assigned
to: $SCEVFIELDS_9\n Severity: $SCEVFIELDS_8"

# annotate and existing ITO message
opcmsg_annotation_add "$SCEVFIELDS_14" "$OPC_Annotate_Text"
```

The previous example pre-formats annotation text to be used to annotate an existing OMU message identified by the message ID stored in event field index 17 of the evfields string.

opcmsg_ack

```
opcmsg_ack <Message Id>
```

Given the message ID of an existing OMU message, this command will acknowledge it as the user defined in the event.ini file.

opcmsg_unack

```
opcmsg_unack <Message Id>
```

Given the message ID of an existing OMU message, this command will unacknowledge it as the user defined in the event.ini file.

opcmsg_own

```
opcmsg_own <Message Id>
```

Given the message ID of an existing OMU message, this command will own it as the user defined in the event.ini file.

opcmsg_disown

```
opcmsg_disown <Message Id>
```

Given the message ID of an existing OMU message, this command will disown it as the user defined in the event.ini file.

opcmsg_op_action_start

```
opcmsg_op_action_start <Message Id>
```

Given the message ID of an existing OMU message, this command will start the pre-defined operator action that the user defined in the event.ini file.

opcmsg_cma_set

```
opcmsg_cma_set <Message Id> <CMA Name> <CMA Value>
```

Parameters:

Message Id **The universally unique message id used by OM.**

CMA Name **The name assigned to the Custom Message Attribute.**

CMA Value **The value assigned to the Custom Message Attribute.**

Example:

```
if [catch {opcmsg_cma_set "$OMU_MSGID" "Ticket Number" "$SC_TICKET"} rc]
{
    tcl_logprint "pmo.tcl: Unable to set CMA Ticket Number for OMU message
($OMU_MSGID)"
    tcl_logprint "pmo.tcl: $rc"
} else {
    tcl_logprint "pmo.tcl: OMU message CMA Ticket Number set to $SC_TICKET"
}
```

tcl_logprint

```
tcl_logprint "Message"
```

This is used to write messages from the tcl script to the SCAuto for OMU log file (scito.log).

Example:

```
tcl_logprint "pmo.tcl: ITO message created for pmo. $SCEVFIELDS_2"
```

Event Configuration File

The `event.ini` file in the `<install_dir>/EventMap/FromSC` directory is a means of configuring the scito component of the interface. In here, you may specify:

- The user name/password to connect to OMU to retrieve message details from its database.
- The TCL map script to invoke when a certain event type is read from ServiceCenter.

Sections

Section header names are identified by square brackets "[...]". The brackets group sets of configurable parameters. There are two required section header names:

CONFIG	Section for specifying OMU username/password to connect as.
EVENT	Section for configuring event types to the TCL map script to execute.

Each section header name has its own set of required parameters.

Section name	Required parameters
CONFIG	<p>OPC_USER - The OMU user name.</p> <p>OPC_PASSWORD - This is the password for the OPC_USER. Optionally, you may specify the string literal USE_ETC_PASSWD in this field. This parameter suppresses the password check.</p>
EVENT	<p><code><event type>=<TCL map script to execute></code></p> <p>For example:</p> <pre>pmo=EventMap/FromSC/pmo.tcl</pre> <p>This will tell the interface to execute the script <code><install dir>/EventMap/FromSC/pmo.tcl</code> when a "pmo" event is received from ServiceCenter.</p>

Default event.ini file.

```
----- begin file -----
[ CONFIG ]
OPC_USER=opc_adm
OPC_PASSWORD=USE_ETC_PASSWD

[ EVENT ]
pmo=EventMap/FromSC/pmo.tcl
pmu=EventMap/FromSC/pmu.tcl
pmc=EventMap/FromSC/pmc.tcl
----- end file -----
```

Default Behavior

When there is a pmo in the eventout table (such as when a ticket is newly created), sctoito treats it as an acknowledgment of the new incident ticket and annotates the originating event. sctito also creates a new ServiceCenter opened event with the IM number being the Object.

When there is a pmu in eventout (such as when its created by a pmu in eventin, or when a ServiceCenter operator modifies the ticket), if the actor or user field is not SCITO, sctoito annotates the originating event and creates a new ServiceCenter update event with the IM number being the Object. This prevents automatic annotations from OMU from going into an infinite loop, updating ServiceCenter and vice-versa.

Similarly, when eventout has a pmc that is not from user SCITO, the originating event will be annotated and a new ServiceCenter closed OMU event will be generated.

Default pmo.tcl Script

```
[comments deleted]
#
#check for OMU message id (should be in field 14) for a value and skip
processing if it's blank
#

set OMU_MSGID "$SCEVFIELDS_14"
```

```

if { $OMU_MSGID != "" } {
    tcl_logprint "pmo.tcl: Processing event $SCEVSYSSEQ for msgid
$OMU_MSGID"

#
*****
****
# BEGIN data block
# Define data value mapping between ServiceCenter event variables to OMU
variables
# to be used by the commands in action block.
#
*****
****

    set SC_TICKET "$SCEVFIELDS_2"

    set OPC_Annotate_Text "Incident ticket $SC_TICKET opened on
$SCEVFIELDS_4 by $SCSCEVUSER\nCategory: $SCEVFIELDS_3\nAssigned to:
$SCEVFIELDS_9\nSeverity: $SCEVFIELDS_8\nLocation: $SCEVFIELDS_21\nContact:
$SCEVFIELDS_32\nPhone: $SCEVFIELDS_34"

    set OPC_Message_Text "Incident ticket $SC_TICKET opened for Message ID
$OMU_MSGID on $SCEVFIELDS_4 by $SCSCEVUSER Category: $SCEVFIELDS_3
Assigned to: $SCEVFIELDS_9 Severity: $SCEVFIELDS_8 Location:
$SCEVFIELDS_21 Contact: $SCEVFIELDS_32 Phone: $SCEVFIELDS_34"

    set OPC_Application "ServiceCenter"

    set OPC_Message_Group "ServiceCenter"

    set OPC_Message_Type "TroubleTicket"

    set OPC_Node_Name "$SCEVFIELDS_18"

#
# convert ServiceCenter severity code to OMU severity using proc defined in
util.tcl
#

    set rc [catch {set SCSEVERITY [ ConvertSeverity "$SCEVFIELDS_8" ]}]
    set OPC_Severity "$SCSEVERITY"

#
*****
****
# BEGIN Action block
# Define OMU message updating/creating logic using variables mapped in
data block.
#
*****
****

#

```



```

# set CMA's
#

if [catch {opcmsg_cma_set "$OMU_MSGID" "Ticket Number" "$SC_TICKET"} rc]
{
    tcl_logprint "pmo.tcl: Unable to set CMA Ticket Number for OMU message
($OMU_MSGID)"
    tcl_logprint "pmo.tcl: $rc"
} else {
    tcl_logprint "pmo.tcl: OMU message CMA Ticket Number set to $SC_TICKET"
}

if [catch {opcmsg_cma_set "$OMU_MSGID" "Assignment" "$SCEVFIELDS_9"} rc]
{
    tcl_logprint "pmo.tcl: Unable to set CMA Assignment for OMU message
($OMU_MSGID)"
    tcl_logprint "pmo.tcl: $rc"
} else {
    tcl_logprint "pmo.tcl: OMU message CMA Assignment set to $SCEVFIELDS_9"
}

if [catch {opcmsg_cma_set "$OMU_MSGID" "Status" "$SCEVFIELDS_12"} rc] {
    tcl_logprint "pmo.tcl: Unable to set CMA Status for OMU message
($OMU_MSGID)"
    tcl_logprint "pmo.tcl: $rc"
} else {
    tcl_logprint "pmo.tcl: OMU message CMA Status set to $SCEVFIELDS_12"
}

if [catch {opcmsg_cma_set "$OMU_MSGID" "ContactName" "$SCEVFIELDS_32"}
rc] {
    tcl_logprint "pmo.tcl: Unable to set CMA ContactName for OMU message
($OMU_MSGID)"
    tcl_logprint "pmo.tcl: $rc"
} else {
    tcl_logprint "pmo.tcl: OMU message CMA ContactName set to
$SCEVFIELDS_32"
}

#
# first try to annotate original message, if message doesn't exist, create
a new one.
# also put in special identifying text **** WARNING **** do not modify
#

if [catch {opcmsg_annotation_add "$OMU_MSGID"
"$OPC_Annotate_Text\n<scito:$SC_TICKET,pmo>"} rc] {
    tcl_logprint "pmo.tcl: Unable to annotate OMU message ($OMU_MSGID) for
pmo. $SC_TICKET"
    tcl_logprint "pmo.tcl: $rc"
} else {
    tcl_logprint "pmo.tcl: Added annotation to OMU message ($OMU_MSGID) for
pmo. $SC_TICKET"
}

```

```

#
# now lets try to own the message.
#

# if [catch {opcmsg_own "$OMU_MSGID"} rc] {
#   tcl_logprint "pmo.tcl: Unable to own OMU message ($OMU_MSGID) for pmo.
$SC_TICKET"
#   tcl_logprint "pmo.tcl: $rc"
# } else {
#   tcl_logprint "pmo.tcl: Owned OMU message ($OMU_MSGID) for pmo.
$SC_TICKET"
# }

#
# lets make a new ServiceCenter message.
#

    if [catch {opcif_write "$OPC_Message_Text" "$OPC_Application"
"$OPC_Message_Group" "$OPC_Message_Type" "$OPC_Node_Name" "$SC_TICKET"
"2"} rc] {
        tcl_logprint "pmo.tcl: Unable to create OMU message for pmo.
$SC_TICKET"
        tcl_logprint "pmo.tcl: $rc"
    } else {
        tcl_logprint "pmo.tcl: OMU message created for pmo. $SC_TICKET"
    }

#
# Not an OMU message
#
} else {
    tcl_logprint "pmo.tcl: Skipping event $SCEVSYSEQ - not an OMU message"
}

```

OMU Business Logic Configuration

This section contains a step-by-step process for configuring OMU to enable automatic event message integration with ServiceCenter. This process is part of the normal configuration process upon installation of SCAuto for OMU.

General Process

Requirements Analysis

To take full advantage of OMU and ServiceCenter integration, you need a high-level plan for application integration. While the integration can automatically create incident tickets from any events managed by OMU, a defined set of application requirements enables you to focus this general capability into specific measurable results.

For example, you can choose to have all kernel alarms open incident tickets automatically, but this process will create hundreds of incident tickets. If the design is reviewed from a requirements standpoint, where the service desk is pursuing operations in accordance with a service level management (SLM) agreement, perhaps it can be refined to open tickets only on critical events from a small set of critical hosts. In this case, defining the requirements helps meet the specific goals of the SLM agreement by notifying the service desk of potentially huge impacts on meeting the contract.

The process of defining requirements precedes the configuration of any software. It consists of analyzing your business and application and service desk requirements, and organizing these requirements to suit your needs. It is the first step in the Analyze, Design, and Implement process described in this section.

Design Phase

After you have defined the requirements of your consolidated service desk environment, you can determine the specific monitored sources help needed to meet these requirements. This is the Design step of the process. In OMU, this amounts to identifying what Message Sources are relevant. This may be done for individual Message Sources or for groups. Beyond noting which Message Sources are relevant, the next step is to define the parameterization and configuration of each relevant Message Source.

Implementation Phase

With a coherent design that meets the requirements, it is then possible to modify the OMU Message Source Templates to meet this design specification. This is the Implement step of the process.

After the modified templates are saved, they need to be pushed to the managed nodes to which they apply. This step, which is the final configuration action, acknowledges that the modified templates are controlled centrally from OMU but are distributed broadly to the nodes or groups that are specified as the appropriate recipients of the policy.

Design Considerations

When designing your system, consider these guidelines:

- If you expect to receive many of the same types of messages that will cause OMU to ServiceCenter interaction, use the Message Stream Interface (MSI). SCAuto for OMU support of MSI involves a daemon process that is constantly waiting for new messages in the message stream. This is not processor intensive, and it is implemented to be a lightweight background process for performing regular, repeated event message processing.
- If you expect to receive fewer and less frequent, and consequently more important messages, use the Trouble Ticket Interface (TTI). SCAuto for OMU support of TTI involves a single thread of execution that is started upon receipt of the event message. This amounts to a processing intensive approach that offers a direct message delivery.

Implementation Steps

This section describes how to configure OMU 8 and OMU 9.

Configuring OMU 8

The following steps describe how to modify a Message Source Template to activate automated event messages from OMU to ServiceCenter. These steps are modeled from a process that implemented a high-level goal, stated as:

Integrate Security alerts into Incident Tickets where any failed switch user (su) command causes OMU alerts.

Task 1: Review templates assigned to a node.

From the OMU Node Bank window, go to the Actions menu, click **Agents**, then click **Assign Templates**.

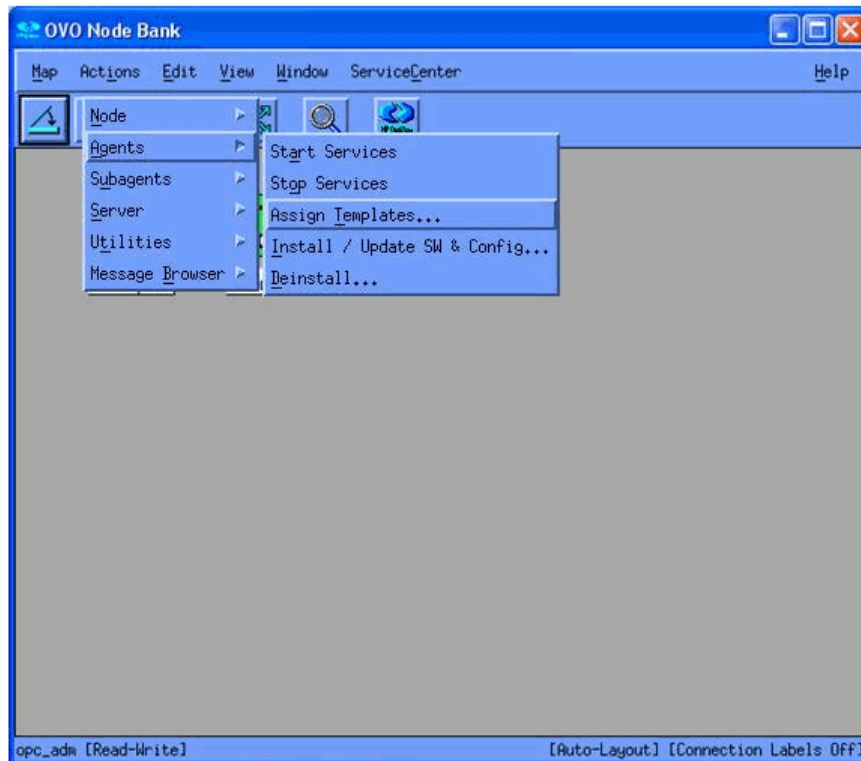

The Define Configuration window opens.

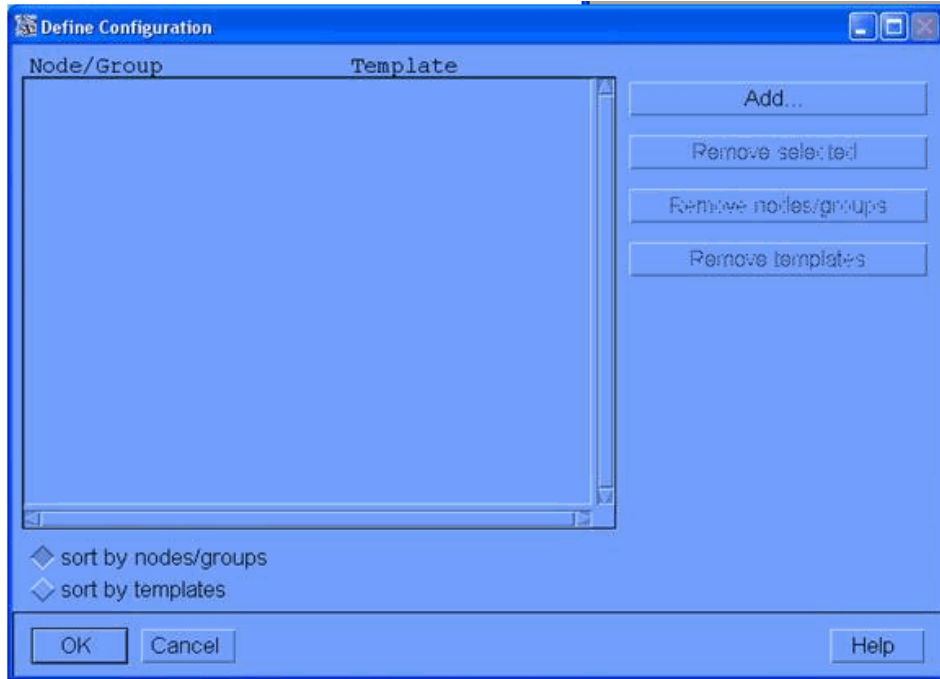

In this window, identify which templates have been assigned to specific nodes or groups. If the template that you want is already assigned, you need to push it out again to its subscribers once you complete your modifications. Plan to do this in addition to, or along with, the template that you push out in [Task 7](#).

Task 2: Begin modifying templates (to assign to a node)

In the OMU Node Bank window, go to the Window menu and click **Message Source Templates**. The Message Source Templates window is displayed. This window contains two panes:

- The left pane contains the message source groups available for you to select.
- The right pane displays the unique Message Source Templates in a selected group. Navigate the groups by clicking on items to show values in the right pane or double-clicking to expand items in the left pane.

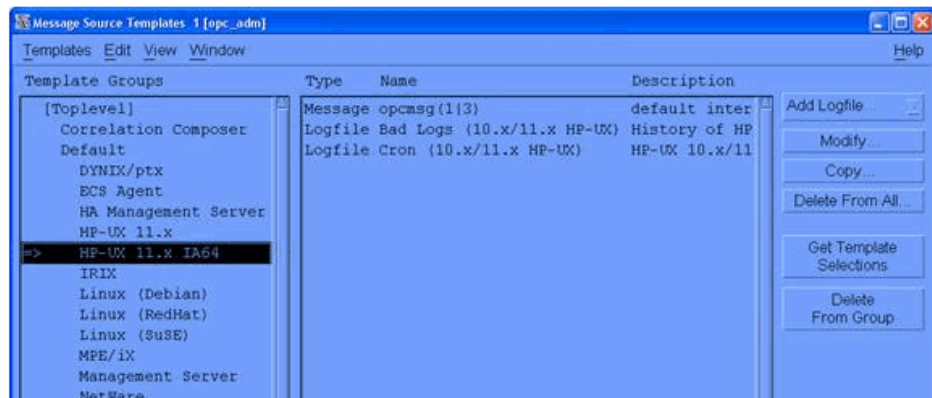
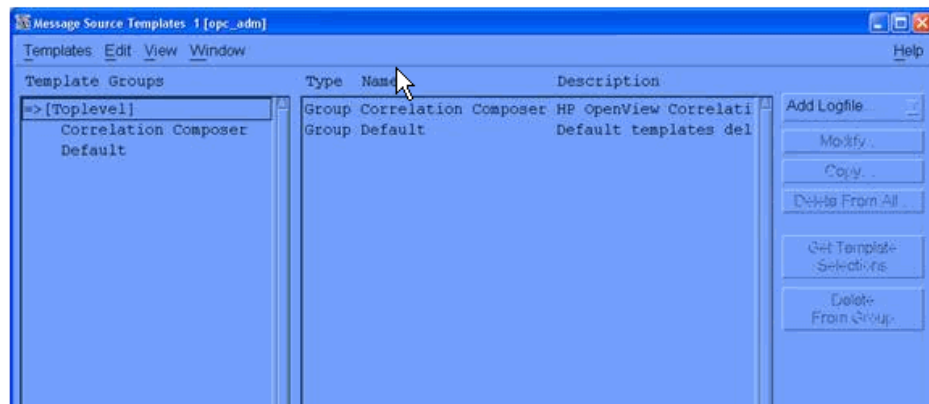
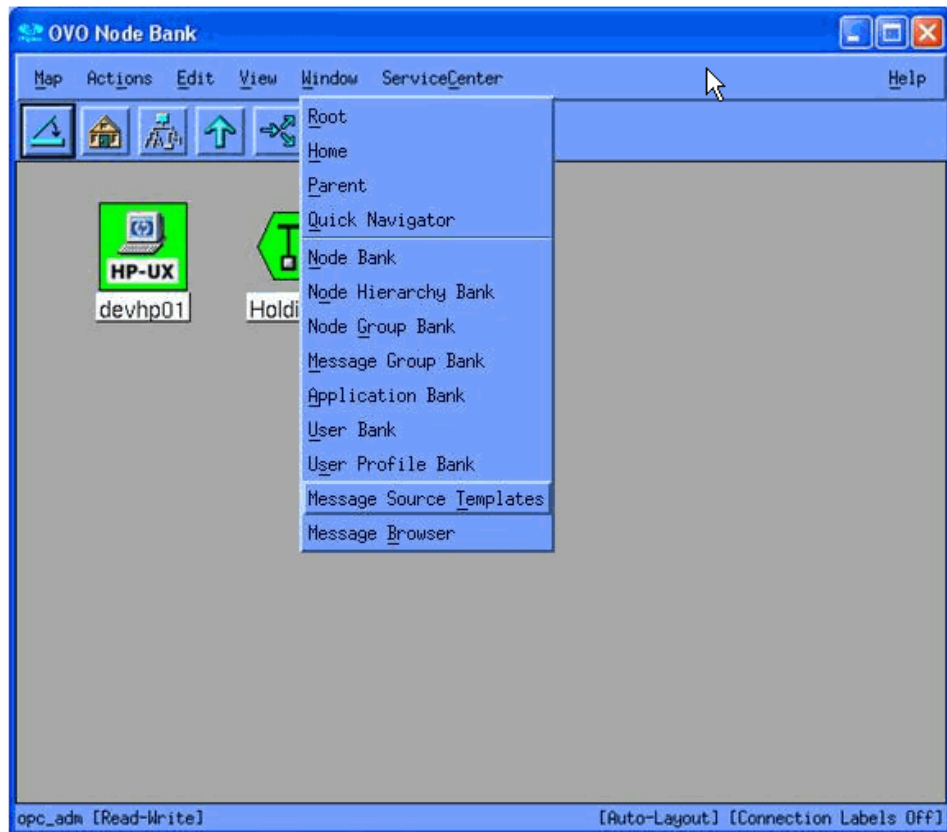

When you find the group you are interested in, select it in the left pane. The **HP-UX 11.x IA64** group is used in this example.

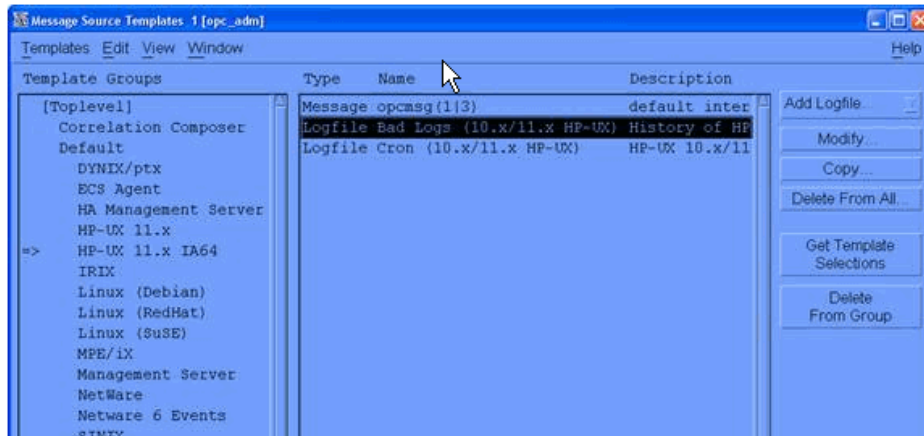

The right pane contains the members of the selected group. For the HP-UX 11.x IA64 group, there is a **Logfile: Bad Logs** item. When this item is selected, it activates the **Conditions** button. Press this button to edit the configuration of the Logfile Bad Logs template. This displays the Message & Suppress Conditions window.

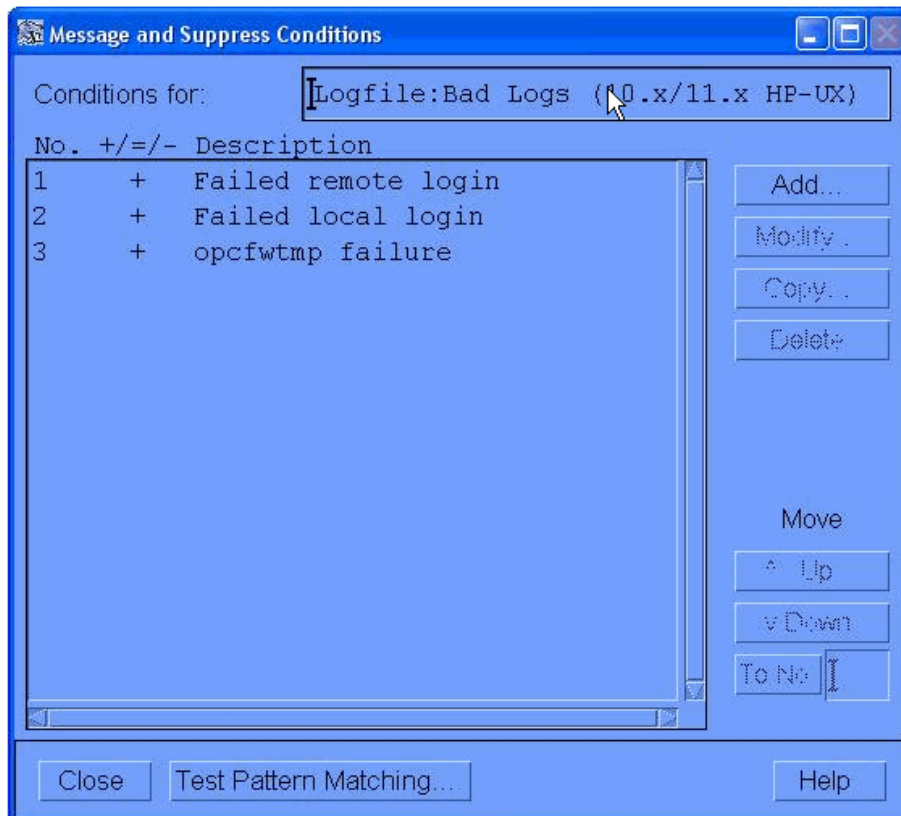

Task 3: Modify templates (to assign to a node)

From the Message & Suppress Conditions window, ensure that the conditions are set as you require. For example, to suppress a condition, be sure that it has a minus sign (-) in the window. To activate a condition, it needs a plus sign (+). To change the setting, select the condition and press the **Modify** button. This displays the Condition No. <N> window (where N is the number of the condition in the list, according to the condition you select).

Condition No. 1

Description
Failed remote login

Condition

Node
[]

Message Text
FAILED <@.user> <@.tty> <@.host> <*.date> <*.time>

- Suppress Matched Condition Advanced Options...
 = Suppress Unmatched Condition
 + Message on Matched Condition

Set Attributes

Severity	Node	Application	Message Group	Object
unchanged	[]	[]	[]	<user>

Message Text
Failed login of <user> on <tty> from <host> at <time> <date>

Service Name
[]

Message Type
[] Custom Attributes... Instructions... Message Correlation...

Actions

	Node	Command	Anno	Ackn
<input type="checkbox"/> On Server Log Only (put directly into History Log)	[]	[]	No	No
Automatic	[]	[]	No	No
Operator initiated	[]	[]	No	No
<input type="checkbox"/> Forward to Trouble Ticket				No
<input type="checkbox"/> Notification				

OK Cancel Test Pattern Matching... Help

Task 4: Modify template conditions to forward to trouble ticket

To invoke the TTI interface, select the **Forward to Trouble Ticket** check box on the Condition No. <N> window. This action completes the Message Source Template configuration. Save your edits by clicking the **OK** button (closes the **Condition No. <N>** window), and proceed to [Task 7](#)



If you wish to use the MSI interface, proceed to the next step without configuring the Trouble Ticket Interface.

Condition No. 2

Description
Failed local login

Condition

Node
[]

Message Text
FAILED <@.user> <@.tty> <*.date> <*.time>

- Suppress Matched Condition
 = Suppress Unmatched Condition
 + Message on Matched Condition

Advanced Options...

Set Attributes

Severity	Node	Application	Message Group	Object
unchanged	[]	[]	[]	<user>

Message Text
Failed login of <user> on <tty> at <time> <date>

Service Name
[]

Message Type
[]

Custom Attributes... Instructions Message Correlation...

Actions

On Server Log Only (put directly into History Log)

	Node	Command	Anno.	Ackn.
Automatic	[]	[]	No	No
Operator initiated	[]	[]	No	No

Forward to Trouble Ticket

Notification

OK Cancel Test Pattern Matching... Help

This form is the same place where you would set up automatic actions, such as executing a command on the node that generated this event message. Certain attributes can also be set here. These attributes can then be used for processing actions in SCAuto for OMU maps (scripts) and can later be used within ServiceCenter. The attribute settings will apply regardless of the choice of MSI or TTI setting.

For example, the Message Group attribute in the center of this form can be set to variable values or literal values (constants). This attribute value is passed to SCAuto for OMU in an environment variable named \$OPCDATA_GROUP. For example, the Message Group attribute can be given a value of TEST in the form. Then, the SCAuto for OMU TCL script can use the \$OPCDATA_GROUP as the name of the category variable used in the ServiceCenter event message. This implies that a new ticket will be created in the TEST incident ticket category, if it exists.

Furthermore, if you create OMU Message Groups that match ServiceCenter incident ticket categories, there will be both a high-level logical relationship between your OMU implementation and your ServiceCenter implementation, and you will also have a detailed connection through this use of message source template attributes.

Task 5: Modify template conditions to use message stream interface.

To use the MSI interface, click the **Advanced Options** button in the Condition No. <N> window. The Message Conditions Advanced Options window opens.

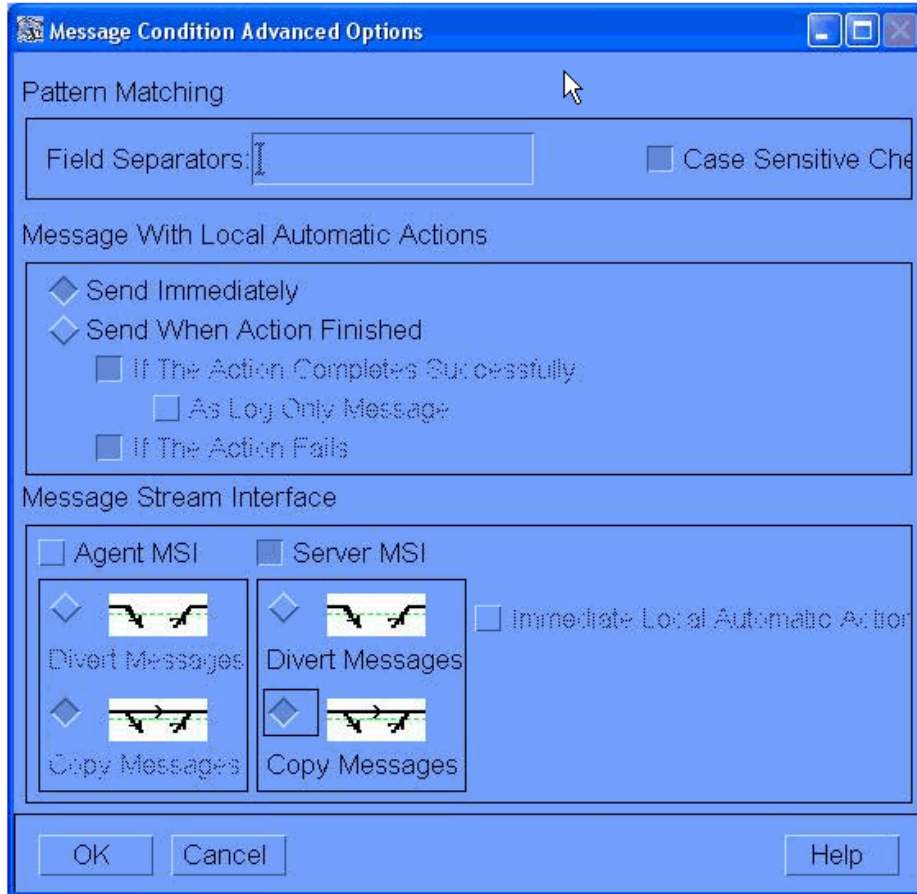

In the Message Conditions Advanced Options window, there is a section labeled Message Stream Interface. Within this section, there are two areas: Agent MSI and Server MSI. Activate just the Server MSI interface by checking the box. Then, select the **Copy Message** button once the Server MSI interface is activated.

Save your edits by clicking the **OK** button. This closes the Message Conditions Advanced Options window. Continue to click the **OK** or **Close** buttons in the remaining open windows until you return to the Message Source Templates window.

Using this form, you can also set up various Message Stream parameters, such as suppressing duplicate event messages.



If you leave the Message Source Template window open, with the selected (now modified) template, this streamlines [Task 6](#).

Task 6: Add modified template to configuration.

From the OMU Node Bank window, go to the **Actions** menu and click **Agents**. Then, click **Assign Templates** to display the Define Configuration window. This process repeats the commands and actions of [Task 1](#).

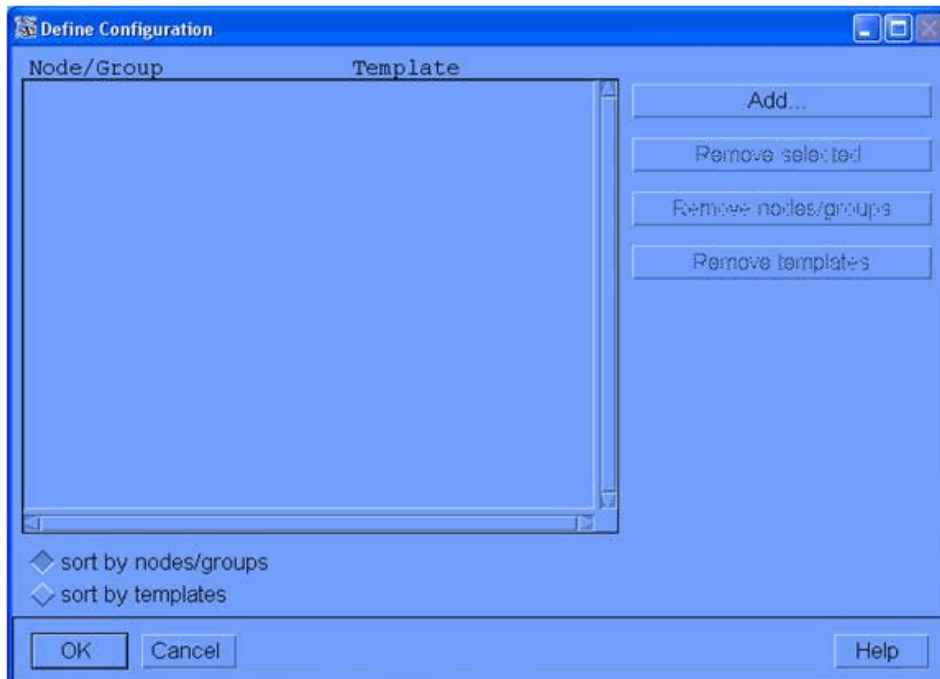
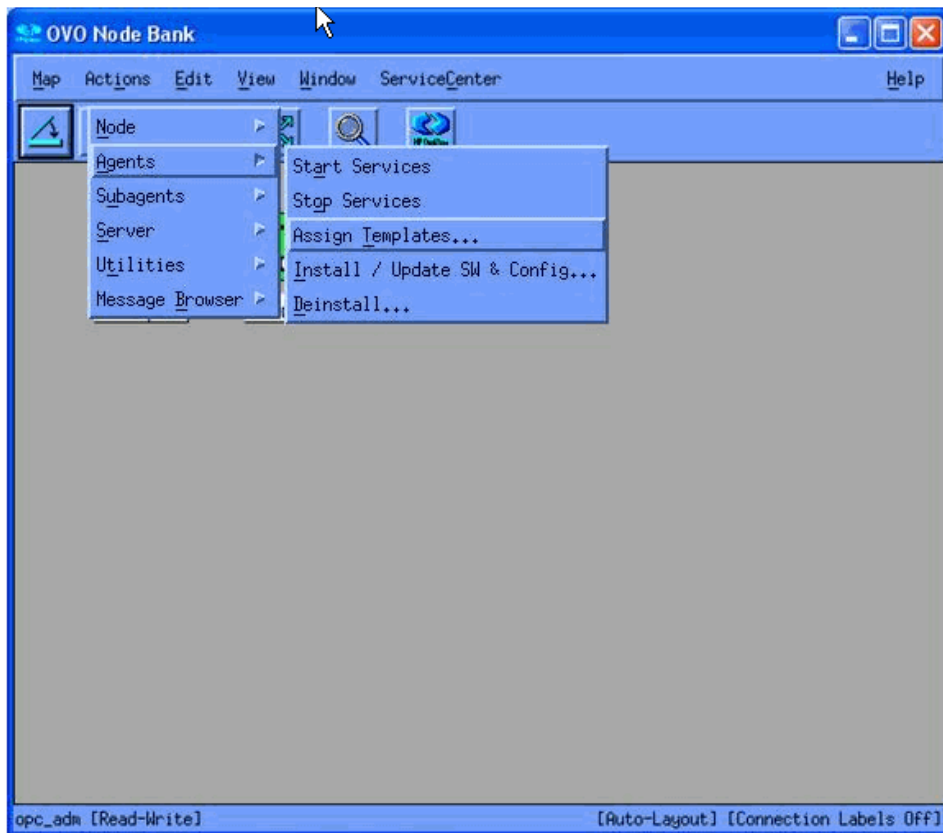

In the Define Configurations window, click the **Add** button to launch an **Add Configurations** window.

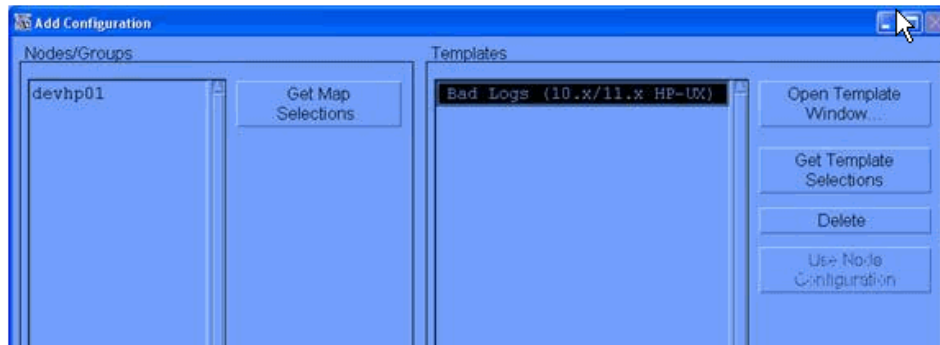

This window contains a **Get Template Selections** button. This is used, for example, when you have an unusual workflow. In this case, you would open a new window, select your modified template in the new window, and then return to the first window and click the **Get Template Selections** button to import your selection.

If your Message Source Template window is still open from the last step, and contains a selected template, you can click the **Get Template Selections** button to complete this step. Otherwise, continue with the instructions here.

To open the window where you can select a template, click the **Open Template Window** button in the Add Configurations window. This displays the Message Source Templates window.

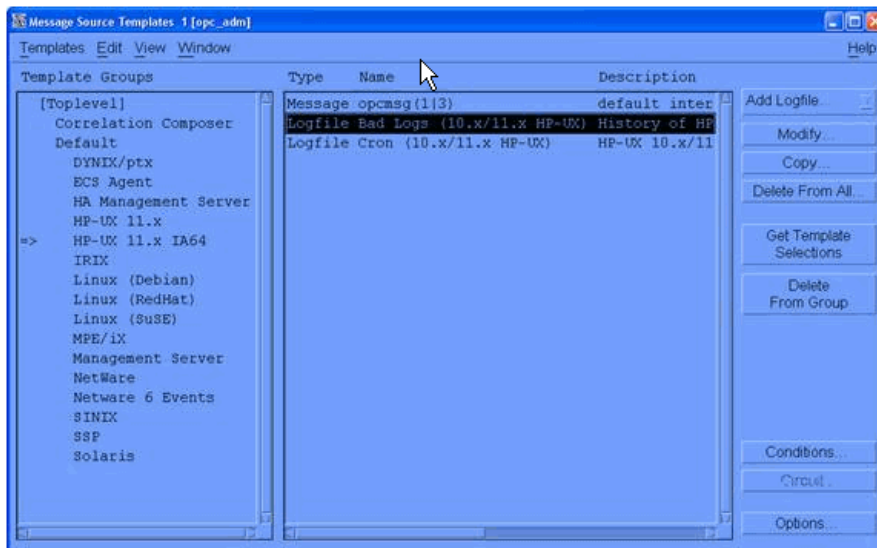
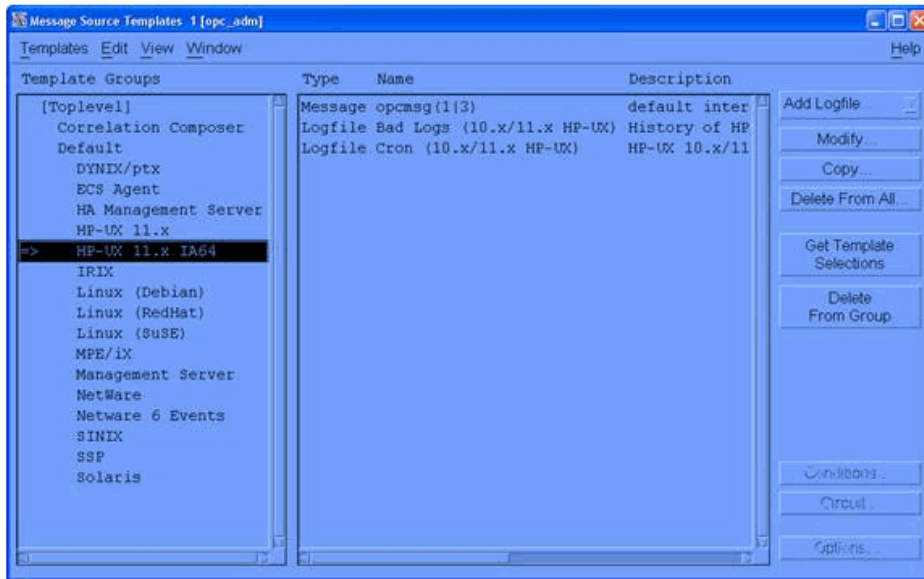

When you finish assigning your modified templates, click the **OK** button to save your edits. This returns you to the Define Configuration window. Verify that your newly assigned template is displayed in this window. Press the **OK** button until you return to the OMU Node Bank window. This completes the steps to define and add the desired templates.

The Message Source Templates window may still be open from [Task 5](#). You can close it now as well.

Task 7: Install Templates to Selected Nodes

This step involves “pushing” the configuration to the endpoints. Once the message source templates are installed at the endpoints, any activity that triggers the template at the nodes will cause OMU event messages and subsequent activation of SCAuto for OMU.

From the OVO Node Bank window, highlight one or more nodes to receive the configuration. On the Actions menu, click **Agents**, then click **Install / Upgrade S/W Configuration**. This displays the Install/Upgrade OVO Software and Configuration window.

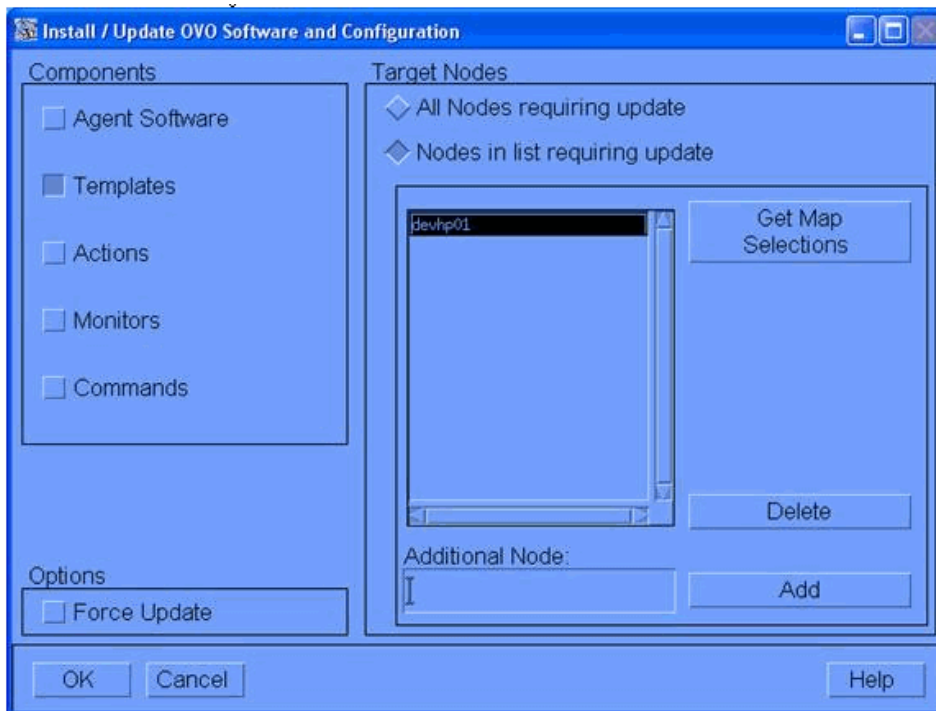
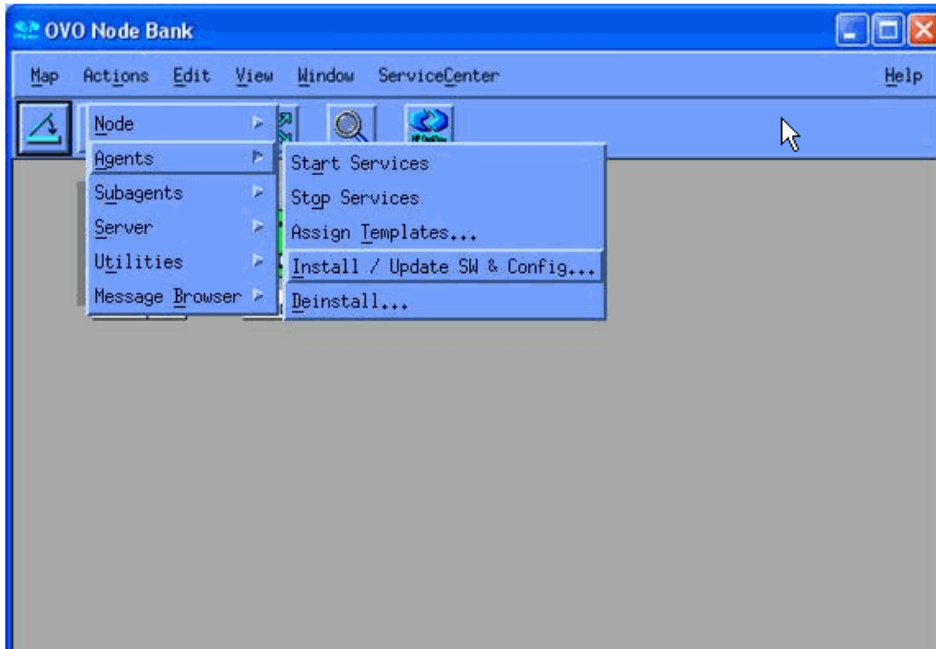

Verify that your node or group is in the list of target nodes. You must also verify that the Templates checkbox is selected in the Components area in the left part of the window. Your message source may also require **Actions**, **Monitors**, and **Commands**.

When you click **OK**, the template configuration is sent to the node and it replaces any existing configuration at the node. If you have an OMU message browser open, you will see an opcdista type of event message that confirms that the configuration has been received by the endpoint .

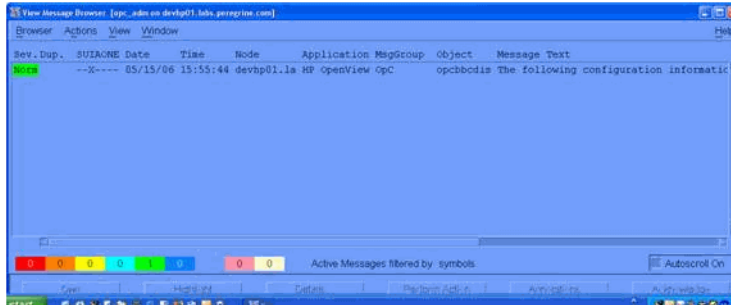

Task 8: Final configuration for use of trouble ticket interface

If you chose to use the TTI interface, there is one additional configuration step. You need to specify which program OMU should run whenever the TTI function is invoked.

From the OMU Node Bank window, go to the **Actions** menu and click **Utilities**. Then, click **Trouble Ticket** to display the Trouble Ticket dialog box.

In the Trouble Ticket dialog box, select the **Use Trouble Ticket System** checkbox. In the Call of Trouble Ticket field, enter a full path name and script name to invoke the SCAuto for TTI program. (The program's name is `TTI.sh`. The default location for this is `/opt/OV/scauto/TTI.sh`; however, your installation may have placed this program in a different location.)

When you click **OK**, OMU will look for and validate that the program is available and executable.

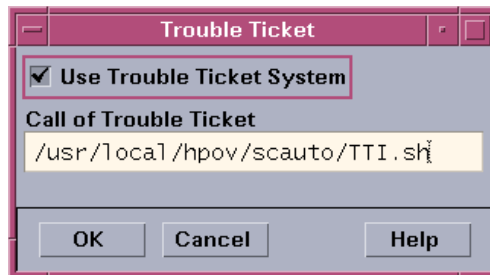

Task 9: Final configuration for use of message stream interface.

From the OMU Node Bank window, select **Actions > Server > Configure**. In the Configure Management Server window under Message Stream Interface, select **Enable Output**.

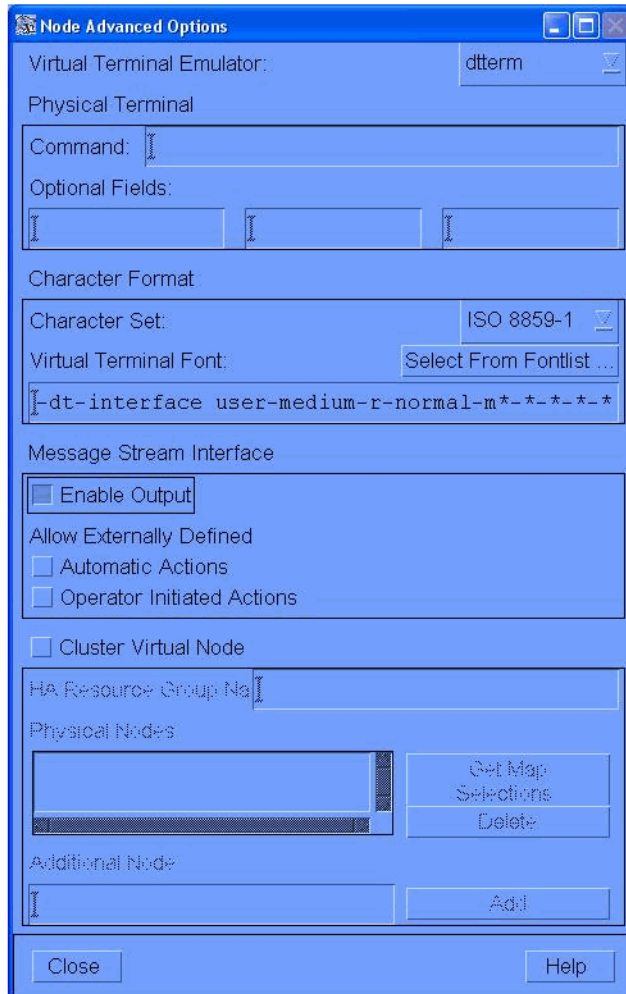

There is one more parameter that must be verified before the configuration is complete. To allow specific nodes to use the MSI or not, OMU has a parameter related to enabling outputs from nodes to the MSI.

From the OMU Node Bank window, select one or more nodes. Right-click the mouse, and click the **Modify** command. This opens the Modify Node window. Click on the **Advanced Options** button, and the Node Advanced Options window appears. In the section of this window labeled Message Stream Interface, click on the **Enable Output** checkbox. This is also the place to enable automatic actions and operator initiated actions.

To save your edits, click **OK** until you get back to the OMU Node Bank window. You are now fully configured for automated event integration between OMU and ServiceCenter.

Node Advanced Options

Virtual Terminal Emulator: hpterm

Physical Terminal

Command: []

Optional Fields: [] [] []

Character Format

Character Set: Roman 8

Virtual Terminal Font: Select From Fontlist ...

am-prestige-medium-r-normal--19-160-72-72-m-110-hp-roman&

Message Stream Interface

Enable Output

Allow Externally Defined

Automatic Actions

Operator Initiated Actions

Installation Method

Default Installation Method

Pull SD Package

Depot: [] From Node: lev.paragrine.com

Compressed Package Transfer

Communication Parameters

Communication Type: DCE RPC (UDP)

DCE Security Level: No Authentication of RPCs

Allowed Port Range: []

Network Security Protocol: None

Logging

Log Directory: /var/opt/OV/log/Op Max. Size (KB): 10000

Close Help

This completes the configuration of the OMU business logic inherent in the Message Source Templates.

Configuring OMU 9

To perform the following configuration tasks, you must log in to the OMU 9 Administration UI.



The image shows the login page for the HP Operations Manager for Unix Administration UI. The top left features the HP logo and the text "HP Operations Manager for Unix". The top right shows a landscape image of a tree in a field under a blue sky. Below the header, there is a login form with the following fields: "User Name" (containing "admin"), "Password" (masked with dots), "Display" (empty), and "Language" (set to "English"). There are "Login" and "Clear" buttons. At the bottom, there is a small icon of a person and some copyright information: "HP Operations Manager for Unix Administration UI 9.0.1 (c)Copyright 2009 blue elephant systems GmbH (c)Copyright 2009 Hewlett-Packard Development Company, L.P."

Task 1: Configuration for use of message stream interface

This includes sever and node configuration, and policy configuration.

Server and Node Configuration

In the Administration UI, select **Edit > Edit Management Server Configuration**.

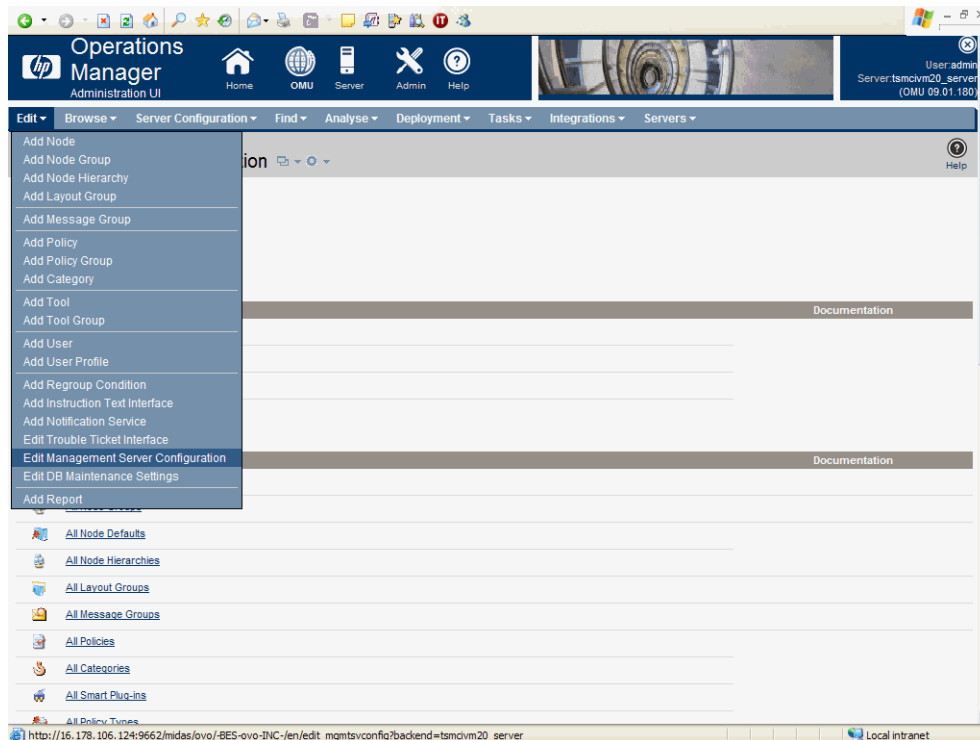

In the Edit Server Configuration page, check the **Enable Output**, and **Send all messages to Server MSI** checkboxes, and select **Divert Messages**. Click **Save**.

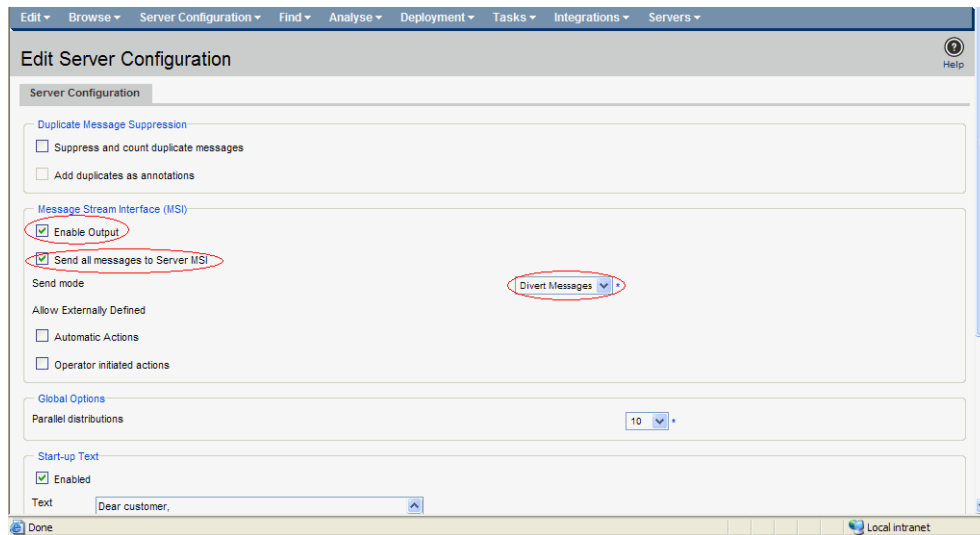

After saving, the Management Server Configuration page should look like the following.

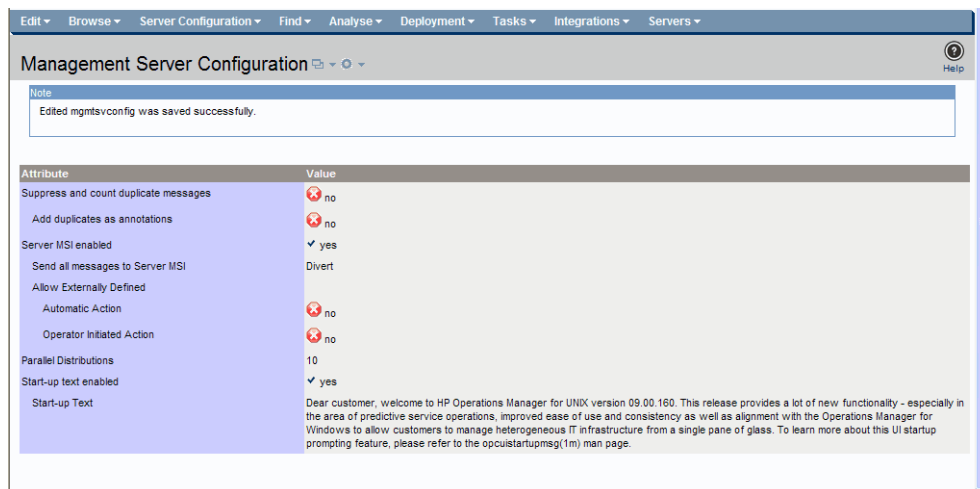

In the Administration UI, select **Browse > Node Bank**.

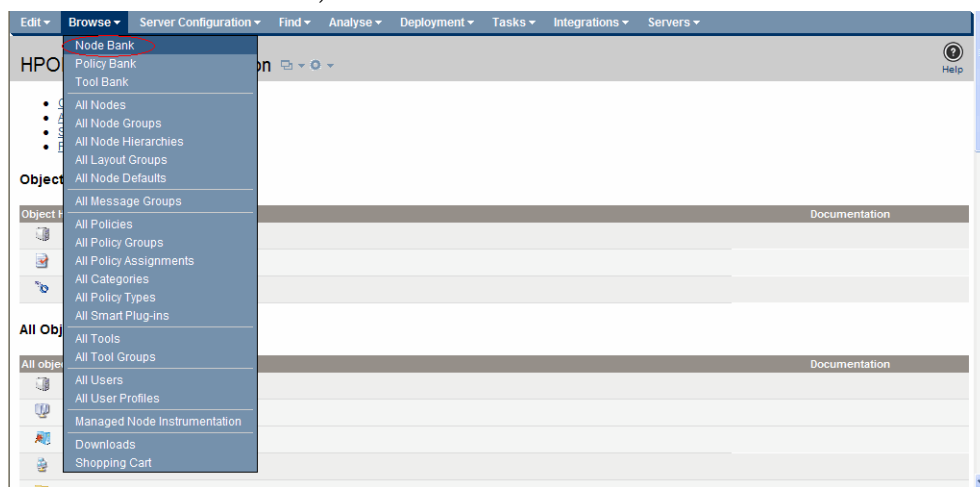

In the Elements in Node Hierarchy "HPOM Node Bank" page, select the node you want to configure, for example, **tsmcivm32**. Select **Edit...** from the **Actions** drop-down menu.

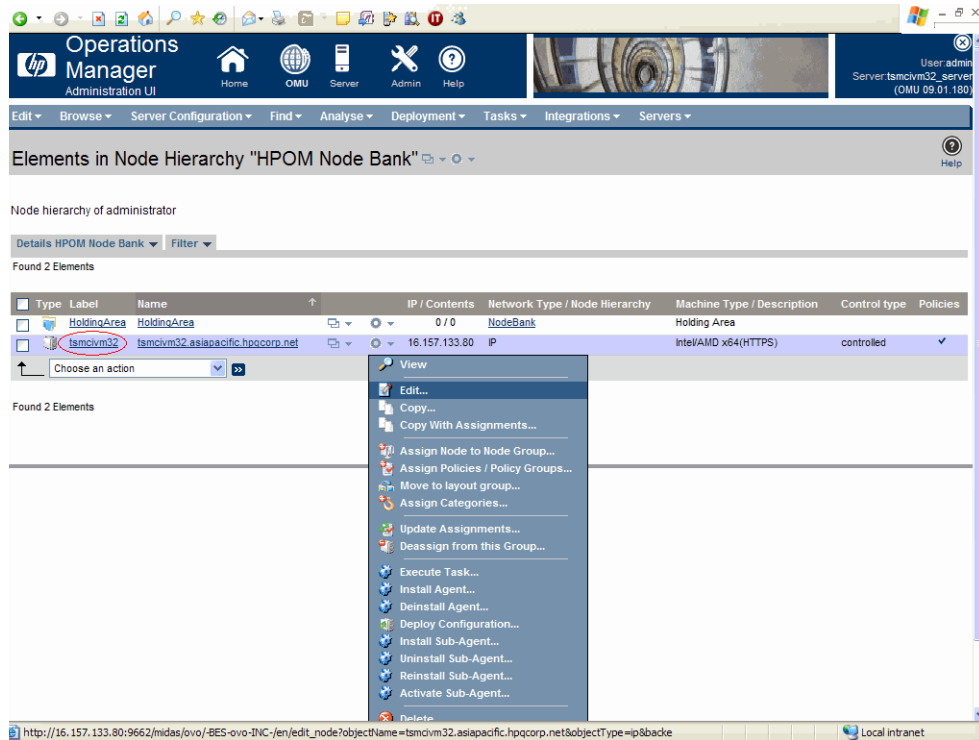

In the Advanced tab of the Edit Node page, check the **Enable Output** checkbox, and then click **Save**.

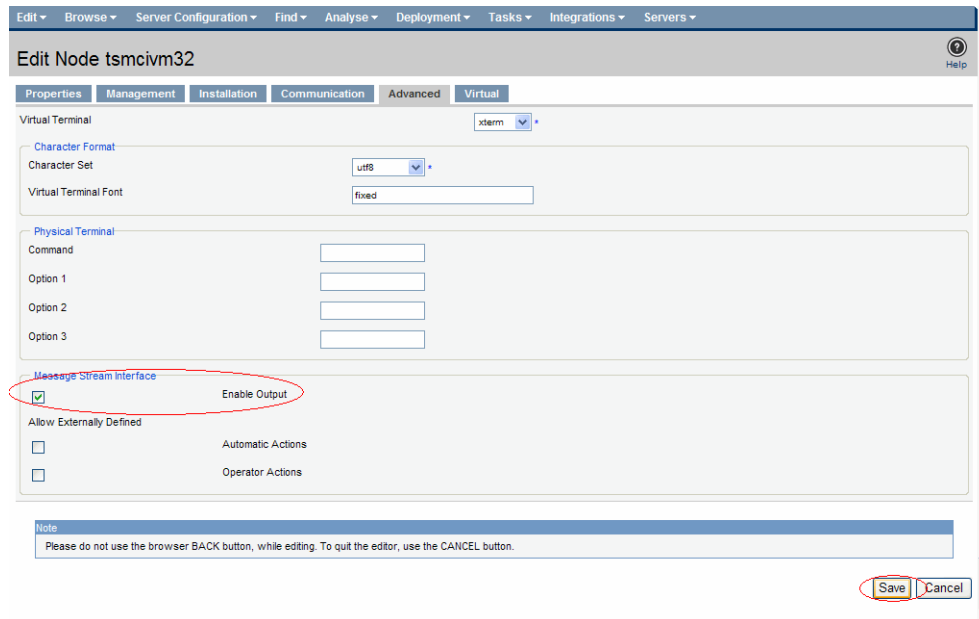

Policy Configuration

The following description takes the "Cron (RedHat Linux)" policy as an example.

In the Policy "Cron (RedHat Linux)" (OM Version 9.0) page, click **Edit**.



In the **Conditions** tab of the Edit Policy page, select the condition that you want to use to send messages to MSI. In the **Advanced** tab, select **Server MSI**, and check the **Divert Messages** checkbox. Click **Save**.

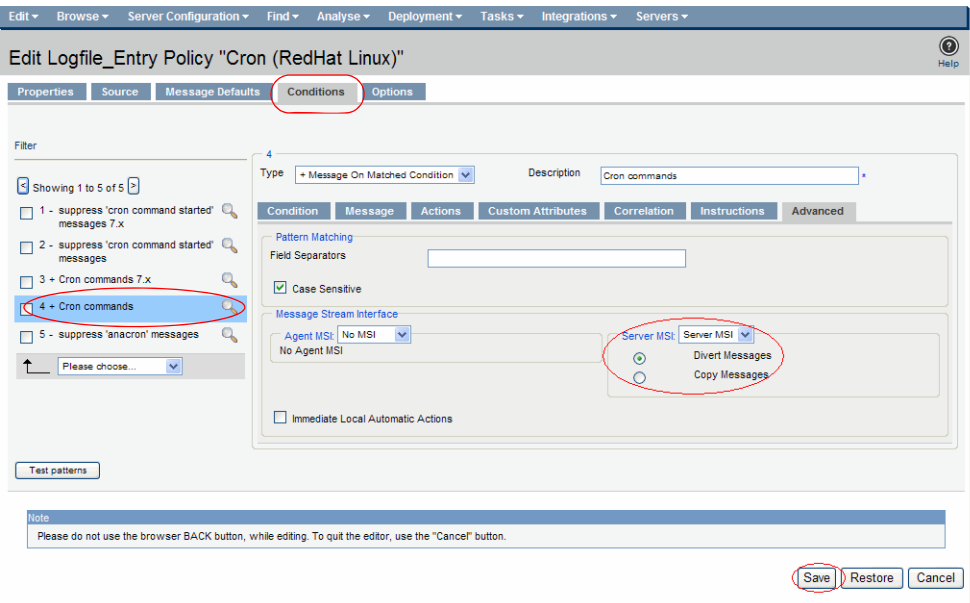

Assign and deploy this policy to Management Server or the node you are interested in.

Task 2: Configuration for use of trouble ticket interface

This includes server configuration and policy configuration.

Server Configuration

In the Administration UI, select **Edit > Edit Trouble Ticket Interface**.

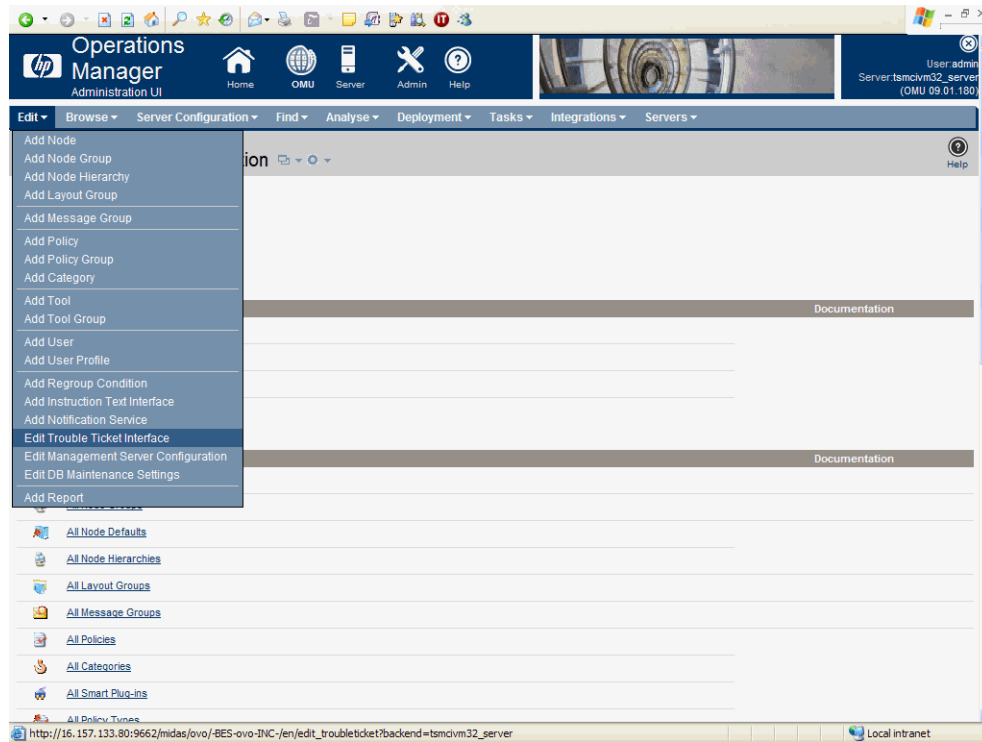

In the Configure the Trouble Ticket Interface page, check the **Use Trouble Ticket System** checkbox, and type `/opt/OV/scauto/TTI.sh` for the “Call of Trouble Ticket Interface” option. Click **Save**.

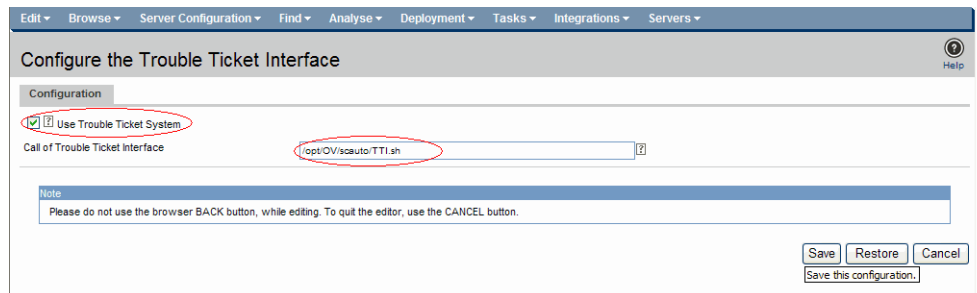

After saving, the Trouble Ticket Interface page should look like the following.

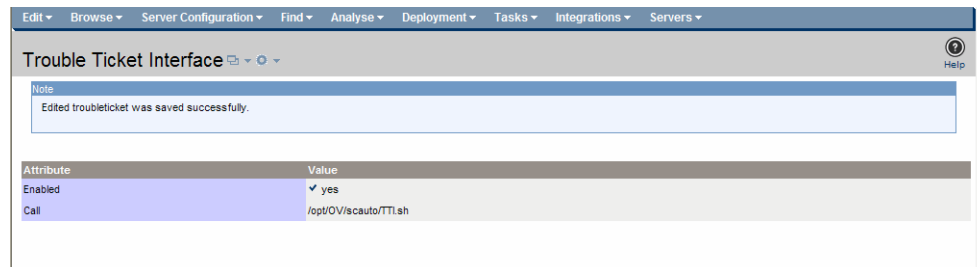

Policy Configuration

The following description takes the "Cron (RedHat Linux)" policy as an example.

In the Policy "Cron (RedHat Linux)" (OM Version 9.0) page, click **Edit**.

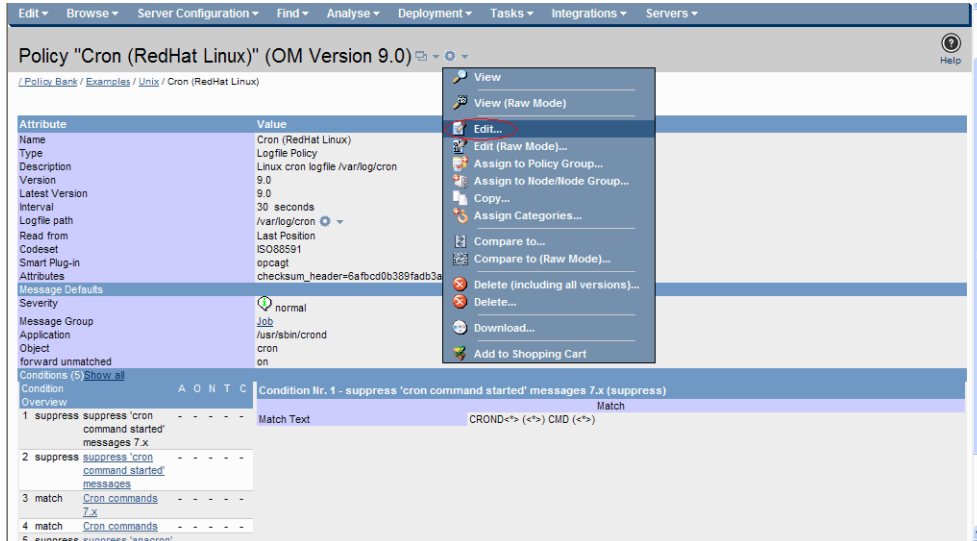

In the **Conditions** tab of the Edit Policy page, select the condition that you want to use to send messages to TTI. In the **Actions** tab, check the **Forward To Trouble Ticket** checkbox. Click **Save**.

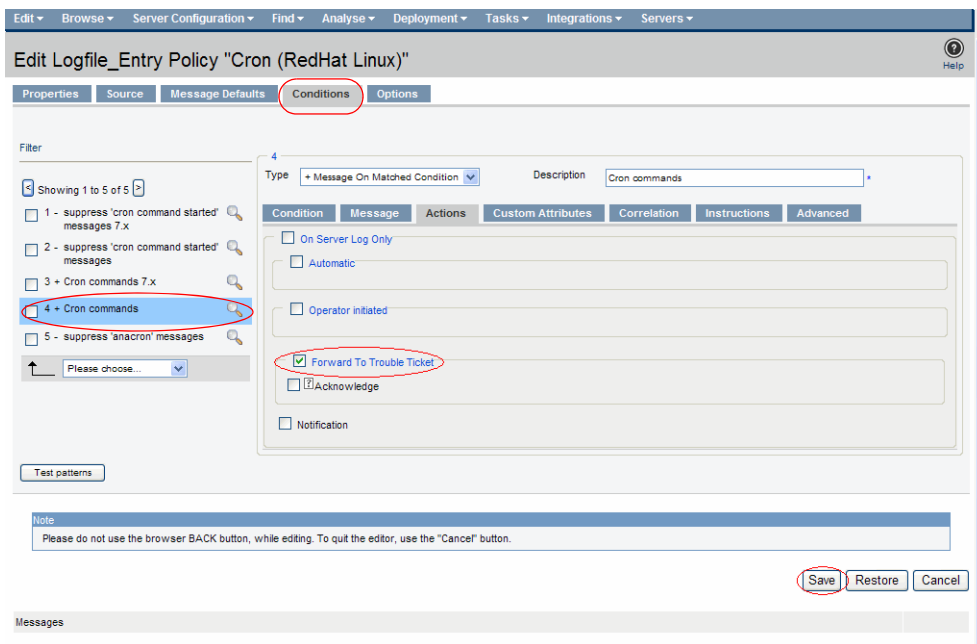

Assign and deploy this policy to Management Server or the node you are interested in.

ServiceCenter Business Logic Configuration

SCAuto integration relies on ServiceCenter Event Services to implement business logic in ServiceCenter. SC event services is responsible for processing input event records generated from OMU messages and creating output event records for integration software to update corresponding OMU messages.

ServiceCenter Event Services

To access Event Services, click the **Event Services** button on the Main ServiceCenter menu. Select the **Administration** tab to reach **Event Registration, Filters, and Maps**.

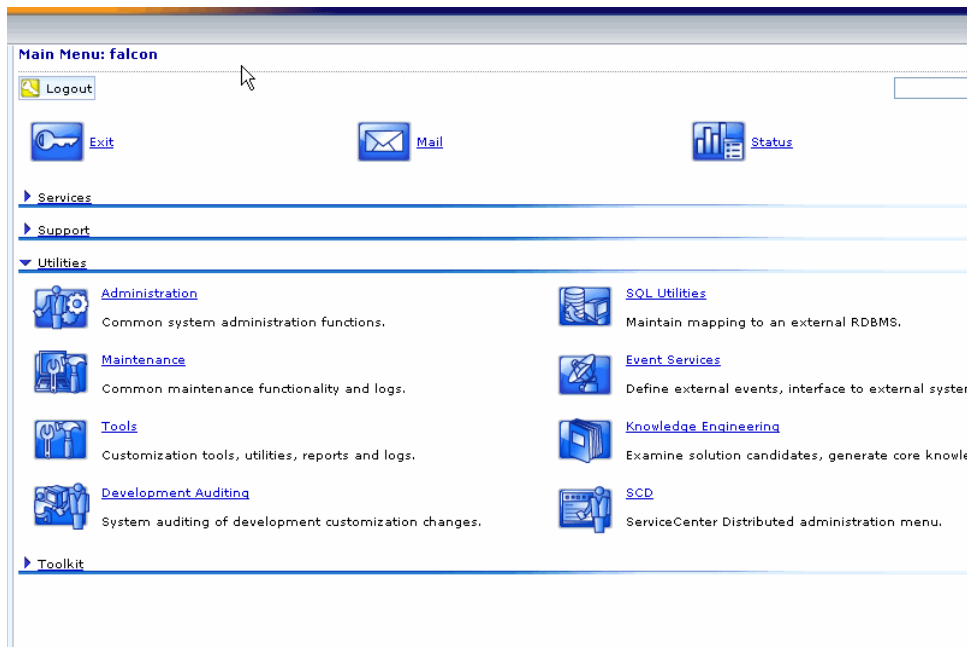

Event Registration

On the Administration tab, click the **Registration** button to display the Event Registration form, which contains the definitions for events processed by the system. The Event Registration form contains three tabs: **Expressions**, **Basics**, and **Application**.

The screenshot shows the 'EVENT REGISTRATION' form in the 'Basics' tab. At the top, there is a search bar with the text 'Search eventregister Records' and a list of actions: 'Back', 'Add', 'Search', 'Find', and 'Fill'. Below the search bar, the form title 'EVENT REGISTRATION' is displayed. The form contains several fields: 'Event Code:' with an empty text box, 'Sequence:' with an empty text box, 'Input or Output?' with a dropdown menu, and 'Translate?' with a dropdown menu. There is also a checkbox labeled 'Process input events synchronously?'. The 'Expressions' tab is currently selected, showing a list of four empty rows for defining processing logic.

The Expressions tab displays the processing logic associated with the event type (for example, pmo).

This screenshot shows the same 'EVENT REGISTRATION' form, but with the 'Expressions' tab selected. The form fields for 'Event Code:', 'Sequence:', 'Input or Output?', and 'Translate?' are visible. The 'Process input events synchronously?' checkbox is also present. The 'Expressions' tab shows a list of four empty rows for defining processing logic, with a vertical scrollbar on the right side.

The Applications tab displays the RAD application that is associated with the event, as well as the parameters that are used when running the application upon processing of the event.

Search eventregister Records

Back Add Search Find Fill

EVENT REGISTRATION

Event Code: Input or Output? Translate?
 Sequence:
 Process input events synchronously?

Expressions Basics **Application**

Application Name:
 Execute Condition:

Description	Parameter Names	Parameter Values
<input type="text"/>	<input type="text"/>	<input type="text"/>
<input type="text"/>	<input type="text"/>	<input type="text"/>

Application to Call on Error Condition:

Event Maps

Event Maps are the guides to recording and processing events, including data type and the name of the file where event data is stored.

Search eventmap Records

Back Add Search Find Fill

Event Map

Map Name: Type: Fixed or Variable:
 Sequence: Position: Length:

Basics Expressions

File Name:
 Query:

Field Name: Nullsub:
 Data Type: Translate:

Array Information

Element Type: Element Separator: Element Separator (structure):
 Element Length:

The Expressions tab contains additional instructions for event processing.

All Event Services features are addressed in greater detail in the *Event Services User's Guide* or ServiceCenter online help. See this guide if you plan to make modifications discussed in this section.

ServiceCenter Incident Management

You may want to customize and configure the definition of incident ticket formats and management in ServiceCenter. Based on your needs, you may need to create additional incident categories to reflect the automatic incident ticket processing supported by the SCAuto for OMU product. You can use the incident category named example as a guide or template to build new automated ticket categories and their associated forms and database dictionary definitions.

The following figure shows a portion of the database dictionary structure for the incident table. This can be used as reference for custom categories based on the probsummary table. For more detailed information, see the *Database Dictionary* section in the *Base Utilities Guide*.

File Name: problem Root Record (if -1 then on SQL): 50373011

Case Mode: Case Sensitive

Field Name	Type	Index	Level
descriptor	Structure	1	0
header	Structure	1	1
number	Character	1	2
number.attach	Character	1	2
vj.number.5	Character	1	2
vj.number.4	Character	1	2
vj.number.3	Character	1	2
vj.number.2	Character	1	2
vj.number.1	Character	1	2

Keys: File Number/Pools

- No Nulls
 - header,number
 - header,last
- Unique
 - header,number
 - header,page

Event data is channeled and presented in ServiceCenter according to controls defined in the Format Control records associated with specific incident category formats (display forms). See the *Format Control Guide* for complete information on Format Control in ServiceCenter.

Additionally, the Forms Designer tool is used to create custom forms for added incident categories and customizations to accommodate the automated incident ticket generation from SCAuto for OMU events. See the *Forms Designer Guide* or ServiceCenter online help for more details on form (format) development and customization.

6 Scenarios

This chapter provides scenarios of different high-level configurations that can be accomplished using SCAuto for Operations Manager for Unix (OMU). Depending on your business needs, the following examples may be implemented individually or in combination to achieve your business goals.

Uni-directional Automatic Incident Ticket Creation (Mode 1)

This implementation is described in [Chapter 1, Introduction](#) as Mode 1 of the Operational Concepts.

In this mode, OMU events drive ServiceCenter tickets. This occurs through the registered connection from OMU to ServiceCenter via the MSI API. This mode requires the following components of SCAuto for OMU:

- `sfromitoMSI` and `scevmon` processes
- ToSC Queue file
- Event Maps (`event.ini`, TCL scripts, and maps referenced in `event.ini`)

In this mode, you only need to start `sfromitoMSI` and `scevmon` processes by executing `ovc -start sfromitoMSI scevmon`.

Bi-directional Incident Ticket/OMU Message Creation/Update/Close (Mode 2)

This implementation is described in [Chapter 1, Introduction](#), as Mode 2 of the Operational Concepts. This is the out-of-box default behavior.

In this mode, OMU events drive ServiceCenter tickets, and the ServiceCenter tickets control OMU events. This amounts to a partnership of managing the events, where each application provides a significant contribution to the event and incident management process. This mode is constructed through the registered connection from OMU to ServiceCenter via the MSI API, as well as the MEI API. This mode requires the following components of SCAuto for OMU:

- `sfromitoMSI`, `sfromitoMEI`, `sctoito`, and `scevmon` processes
- ToSC and FromSC Queues
- Event Maps (`event.ini`, TCL scripts, and maps referenced in `event.ini`)

You can start the adapter processes by using the OMU command `ovc -start sfromitoMSI sfromitoMEI sctoito scevmon`. To stop the adapter processes, you can execute `ovc -stop sfromitoMSI sfromitoMEI sctoito scevmon`.

Creating Incident Tickets with Trouble Ticket Interface (Mode 3)

This implementation is described in [Chapter 1, Introduction](#), as Mode 3 of the Operational Concepts.

This mode is an alternative configuration of Mode 1 (Uni-directional) or Mode 2 (Bi-directional). It uses the OMU TTI API instead of the MSI API. This allows for a more focused configuration of OMU Message Source Templates, freeing the MSI API to be used for other integration efforts, if desired. MEI usage with this mode is identical to the previous modes.

This mode requires the following components of SCAuto for OMU:

- `sfromitoTTI` and `SCEVMON` processes
- ToSC and FromSC Queues
- Event Maps (`event.ini`, TCL scripts, and maps referenced in `event.ini`)
- IT/O configurations for TTI to execute `<installed directory>/TTI.sh`, as well as source templates to Forward message to Trouble Ticket Interface.

Node-based Incident Tickets

By default, after installing the product, the To ServiceCenter TCL scripts are configured to generate `pmo` events with the category of `example`. Also, the default behavior for the `example` category in ServiceCenter is to match incident tickets based on the `logical.name` field in the `pmo` event. If this is the desired effect, you do not have to customize the product.

If you want the `pmo` to go into a specific ServiceCenter category, you must take the following steps:

- Make sure that the targeted category contains format control logic to handle a pmo the same way as the example category.
- Customize the TCL scripts to generate the desired category in the resulting pmo event.

See [Chapter 5, Configuration](#) for more information about these steps.

Cause-based Incident Tickets Per Node

This implementation is primarily designed for a typical OMU configuration. It essentially takes the node-based concept of OpenView NNM to another level, to an Application-based or Cause-based event per node in the managed environment.

For example, in a node-based system, every event that is configured to be captured by OMU on the same node will funnel into the same incident ticket, regardless of the nature or cause of the message. In contrast, a Cause-based or Application-based system makes a distinction, for example, between a Security event and an OS event by opening different incident tickets for these events. By default, ServiceCenter and SCAuto for OMU are cause-based.

OMU Message Group into ServiceCenter Category

This implementation facilitates the management of large numbers of OMU event messages by funneling them into different ServiceCenter categories based on the OMU Message Group name. This enables the OMU Administrator to control which OMU message opens a incident ticket in which category. This grouping of incident tickets by OMU Message Groups is a logical approach to eventually assigning incident tickets to the same group of technical support staff based on their expertise.

To configure for incident tickets to be opened in categories specified by the Message Group of the OMU Message:

- In ServiceCenter, create categories matching the OMU Message Group names. This will later enable the SCAuto for OMU adapter to assign events to these specific categories based on the OMU Message Group of the interested event. Also, make sure that the correct event registration and format control logic are built into these new categories.
- In SCAuto for OMU, modify the default “ToSC” TCL scripts to generate specific category and cause.code in the resulting pmo. By default, the category field is hard-wired to the literal example. If desired, you can use the OMU Message Group value to populate this field by changing the line:

```
eventObject set_evfield category example

to

eventObject set_evfield category $OPCDATA_GROUP
```

