hp OpenView TeMIP



SQM TeMIP Gateway

Installation, Configuration and User's Guide

Edition: 1.2

January 2005

© Copyright 2005 Hewlett-Packard Company

Legal Notices

Warranty

Hewlett-Packard makes no warranty of any kind with regard to this manual, including, but not limited to, the implied warranties of merchantability and fitness for a particular purpose. Hewlett-Packard shall not be held liable for errors contained herein or direct, indirect, special, incidental or consequential damages in connection with the furnishing, performance, or use of this material.

A copy of the specific warranty terms applicable to your Hewlett-Packard product can be obtained from your local Sales and Service Office.

Restricted Rights Legend

Use, duplication or disclosure by the U.S. Government is subject to restrictions as set forth in subparagraph (c)(1)(ii) of the Rights in Technical Data and Computer Software clause in DFARS 252.227-7013.

Hewlett-Packard Company

United States of America

Rights for non-DOD U.S. Government Departments and Agencies are as set forth in FAR 52.227-19(c)(1,2).

Copyright Notices

©Copyright 2000-2004 Hewlett-Packard Company, all rights reserved.

No part of this document may be copied, reproduced, or translated to another language without the prior written consent of Hewlett-Packard Company. The information contained in this material is subject to change without notice.

Trademark Notices

Adobe® and Acrobat® are trademarks of Adobe Systems Incorporated.

HP-UX Release 10.20 and later and HP-UX Release 11.00 and later (in both 32 and 64-bit configurations) on all HP 9000 computers are Open Group UNIX 95 branded products.

Java™ is a U.S. trademark of Sun Microsystems, Inc.

Microsoft® is a U.S. registered trademark of Microsoft Corporation.

Netscape is a U.S. trademark of Netscape Communications Corporation.

NMOS™ is a trademark of RiverSoft Technologies Limited.

Oracle® is a registered U.S. trademark of Oracle Corporation, Redwood City, California.

Oracle7™ and Oracle7 Server™ are trademarks of Oracle Corporation, Redwood City, California.

PostScript® is a trademark of Adobe Systems Incorporated.

Riversoft™ is a trademark of RiverSoft Technologies Limited.

UNIX® is a registered trademark of The Open Group.

Windows® and Windows NT® are U.S. registered trademarks of Microsoft Corporation.

X/Open® is a registered trademark, and the X device is a trademark of X/Open Company Ltd. in the UK and other countries.

All other product names are the property of their respective trademark or service mark holders and are hereby acknowledged.

Contents

Preface	5
Chapter 1	7
Introduction	7
1.1 OpenView Service Quality Manager	7
1.2 OpenView TeMIP	8
1.3 SQM TeMIP Gateway solution.....	8
Chapter 2	9
What does the SQM TeMIP Gateway Perform?	9
2.1 Reporting of SQM Events in TeMIP	10
2.1.1 Associating the SNMP Action Executor to SQM Events	10
2.1.2 SQM TeMIP Gateway Entity Model.....	11
2.1.3 TeMIP Alarm Mapping from SQM Event	12
2.1.4 Displaying Alarms	23
2.2 SQM SLA Monitoring and TeMIP Client Integration	24
2.2.1 From TeMIP Client to SQM SLA Monitoring.....	24
2.2.2 From SQM SLA Monitoring to TeMIP Client.....	25
Chapter 3	27
Architecture Overview	27
Chapter 4	29
SQM TeMIP Gateway Lifecycle on SQM SLM Primary Server.....	29
4.1 Software and Hardware Requirements.....	30
4.2 SQM SNMP Action Executor	30
4.2.1 Installation.....	30
4.2.2 Configuring for the SQM TeMIP Gateway	30
4.2.3 Configuring the SLA Administration.....	31
4.2.4 Startup, shutdown and configuration reloading	31
4.2.5 Uninstallation	31
Chapter 5	33
SQM TeMIP Gateway Lifecycle on TeMIP Director.....	33
5.1 Software and Hardware Requirements.....	34
5.2 SQM TeMIP Gateway Management Modules for TeMIP V5.....	34
5.2.1 Installation.....	34
5.2.2 Configuration.....	35
5.2.3 Starting and Stopping the SQM TeMIP Gateway SNMP AM	39

5.2.4	Starting and Stopping the SQM TeMIP Gateway Model FM	39
5.2.5	Uninstallation	39
Chapter 6	41
SQM TeMIP Gateway Lifecycle on the Monitoring Director	41
6.1	Software and Hardware Requirements.....	41
6.2	SQM TeMIP Client Plug-in.....	42
6.2.1	Installation.....	42
6.2.2	Setting-up the Plug-in for the TeMIP Client	45
6.2.3	Uninstallation	46
Appendix A	49
Troubleshooting	49
An Error Occurred when Initializing the Clone's Event Sink SNMP Session		49
SNMP Trap OID is not defined in the dictionary		49
On V5, Traps are not Forwarded		49
Additional Text Parsing Problem.....		50
No alarm displayed in the TeMIP Client Alarm Handling.....		50
Appendix B	51
Additional Text Parsing Configuration	51
Introduction.....		51
Customizing the TeMIP SQM Gateway Management Module Additional Text format		52
Merging an TeMIP Client alarm object fields customization		54
Appendix C	56
TeMIP IST Configuration	56
Appendix D	57
Manual registration of the TeMIP Global Instances	57
Discovery.....		57
Registration		58
Declaration as member of the SQM domain.....		59

Preface

This document describes how to install and configure the HP OpenView Service Quality Manager (SQM) TeMIP Gateway solution. It provides an overview of the SQM TeMIP Gateway solution and describes how to:

- Install the SQM TeMIP Gateway
- Set up the SQM TeMIP Gateway
- Start and stop the SQM TeMIP Gateway.

Intended Audience

This document addresses service designers, service operators, and anyone involved in service monitoring who needs to understand how SQM can be connected with TeMIP fault management.

Required Knowledge

It is assumed that the reader is familiar with the functionality of OpenView SQM and has previous experience of the following:

- System administration and operations
- Service Level Management

It is assumed that the reader is familiar with the concepts described in the following books:

- *OpenView SQM Overview*
- *OpenView SQM Installation Guide*
- *OpenView SQM SLA Monitoring UI User's Guide*
- *OpenView SQM Getting Started Guide*
- *OpenView SQM Planning Guide*
- *OpenView SQM Installation Guide*
- *OpenView SQM Administration Guide*
- *OpenView SQM Action Executor for SNMP User's Guide*

Refer to the following document for useful reference information:

- *OpenView TeMIP Installation Guide.*
- *OpenView TeMIP Planning guide.*
- *OpenView TeMIP State Management Users' Guide.*
- *OpenView TeMIP Fault Management User's documentation.*
- *HP OpenView TeMIP - Internet SNMP Toolkit (IST) Configuration and Troubleshooting Guide (TeMIP V5).*

Software Versions

The term UNIX is used as a generic reference to the operating system, unless otherwise specified.

The software versions referred to in this document are specified for each hosts in Sections:

- 4.1 - Software and Hardware Requirements.
- 5.1 - Software and Hardware Requirements.
- 6.1 - Software and Hardware Requirements.

Typographical Conventions

The following typographical conventions are used in this book:

Bold	New terms and to emphasize important words.
<i>Italic</i>	File names, programs, and parameters. The names of other documents referenced in this manual.
Monospace	Source code and examples of file contents. Commands that you enter on the screen. Pathnames. Keyboard key names.

Associated Documents

For a full list of TeMIP user documentation, refer to Appendix A of the *OpenView TeMIP Product Family Introduction*.

For a full list of OpenView SQM user documentation, refer to the *HP OpenView Service Quality Manager Product Family Introduction*.

Support

Please visit our HP OpenView web site at: [HP OpenView](#)

There you will find contact information as well as details about the products, services, and support HP OpenView has to offer.

The HP OpenView support area of the HP OpenView web site includes:

- Downloadable documentation
- Troubleshooting information
- Patches and updates
- Problem reporting
- Training information
- Support program information

Introduction

1.1 OpenView Service Quality Manager

OpenView SQM provides a complete service quality management solution. It consolidates quality indicators across all domains — telecom, IT networks, servers, and applications — providing end-to-end visibility on service quality. OpenView SQM links service quality degradations to potential effects on business, allowing network support personnel to address problems and prioritize actions proactively.

OpenView SQM monitors the service quality by aggregating information coming from all data sources, such as the network, the IT infrastructure, and the service provider's business processes. Using this information, service operators can pinpoint infrastructure problems and identify their potential affect on customers, services, and Service Level Agreements (SLAs).

Figure 1 OpenView SQM Main Components

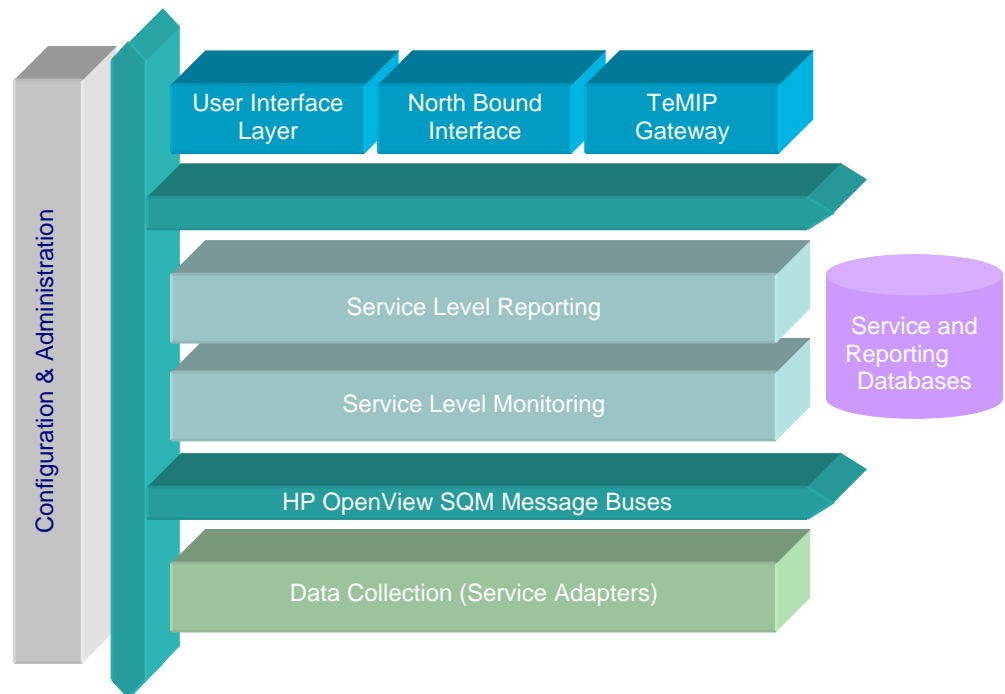

For a detailed description of OpenView SQM, refer to the *HP OpenView Service Quality Manager Overview*.

1.2 OpenView TeMIP

OpenView TeMIP is the HP OpenView family of software products for the management of telecommunications networks, addressing the needs of operators of fixed, wireless, voice, data and IP networks. The TeMIP product family provides multi-vendor and multi-technology integration for switching, transmission, optical, IP and data, and cellular radio, including the migration to next generation of fixed and mobile networks.

For more information on TeMIP product family, please refer to the *OpenView TeMIP Product Family Introduction*.

1.3 SQM TeMIP Gateway solution

Based on these product families, HP has built a solution that integrates SQM with TeMIP. Through TeMIP and SQM, HP provides comprehensive network, service and service level management, for the assurance, fulfillment, service and business processes. With an HP OSS integrated with SQM, solution network and service operators can improve the speed and quality of service they deliver, while reducing the cost of operation.

OpenView SQM TeMIP Gateway solution is an “interface” designed specifically for the OpenView TeMIP Fault Management solution. It exports a full OpenView TeMIP fault model in Management Specification Language (MSL) and acts as a bridge between OpenView SQM northbound and TeMIP, collecting data from OpenView SQM, and reporting these data into TeMIP.

So the OpenView SQM TeMIP Gateway solution translates service degradations, SLA violations, and compliance alarms into OpenView TeMIP fault management OSI alarms.

Chapter 2

What does the SQM TeMIP Gateway Perform?

Once TeMIP, SQM, and the SQM TeMIP Gateway solution are installed and configured, the SQM TeMIP Gateway solution mainly offers the two following functionalities:

- The reporting of SQM Events in TeMIP.
- The TeMIP Client integration with SQM SLA Monitoring UI for Windows.

The SQM TeMIP Gateway solution is composed of the following components:

SQM SNMP Action Executor with special customization

SQM TeMIP Gateway Management Modules:

- SQM TeMIP Gateway SNMP Access Module
- SQM TeMIP Gateway Model Functional Module

TeMIP Client Plug-In for SQM

Their interactions are described in the following figure:

Figure 2 Interactions between components of the TeMIP Gateway solution

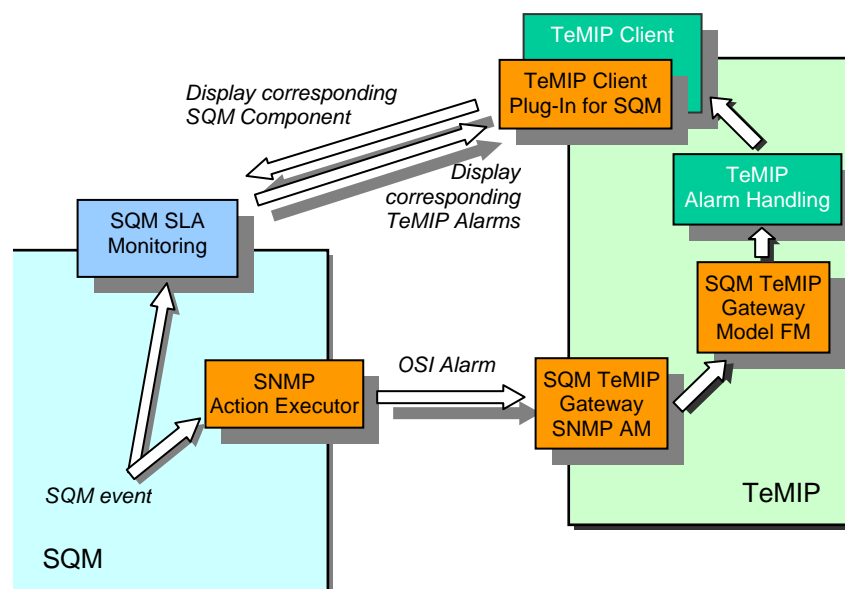

2.1 Reporting of SQM Events in TeMIP

The SQM TeMIP Gateway solution reports in TeMIP the following SQM Events:

- Service and Service components degradations and violations.
- SLA degradation and violation.
- Parameter Threshold crossing.
- Compliance Service and Service component degradations and violations.
- SLA compliance degradation and violation.
- Compliance parameter threshold crossing.

These events are reported to TeMIP via “TeMIP fault management OSI alarms” that are emitted by the SQM SNMP Action Executor. These alarms are listened and managed by the SQM TeMIP Gateway Management Modules AM before being reported in the TeMIP Alarm Handling.

The emitted OSI alarms have a managed object, global classes of which are mapped from the originating SQM entities: SERVICE_CUSTOMER for the Customer related events and SERVICE_OPERATION for the Operation related events. A third global class maps such SQM events when several customers or operations are impacted: SERVICE_ROOT.

2.1.1 Associating the SNMP Action Executor to SQM Events

The Association between the SNMP Action Executor and the SQM Events is done:

- For Parameter Threshold Crossing events, at Service Level Objective (SLO) definition level
- For Objective Status Changed events:
 - At SNMP Action Executor filter configuration if the Objective Status filtering is enabled (default configuration).
 - At SLO definition is if the Objective Status filtering is disabled.

The association of the SNMP Action Executor to SQM events is described in the *SQM Action Executor for SNMP User's Guide* document.

The only difference with others SNMP Action Executor lies in the name used to associate the SNMP Action Executor with a SLO.

Association of the SNMP Action Executor with the SLO for the TeMIP Gateway solution

To send OSI Alarms when a parameter crosses a SLO threshold, the SLO definition must have the following action executor:

- Executor: **TeMIPAlarm**
- Action: **SendAlarm**
- The **On Argument** and **Off Argument** provide the severity of the emitted OSI Alarm when the parameter threshold is crossed. See Section 2.1.3.1 OSI Alarm on Parameter Threshold Crossing, which explains how these two severity arguments are used.

Important

The Executor, Action, On Argument and Off Argument fields are case sensitive.

Figure 3 Defining a threshold with Action Executor in the SLA Administration UI

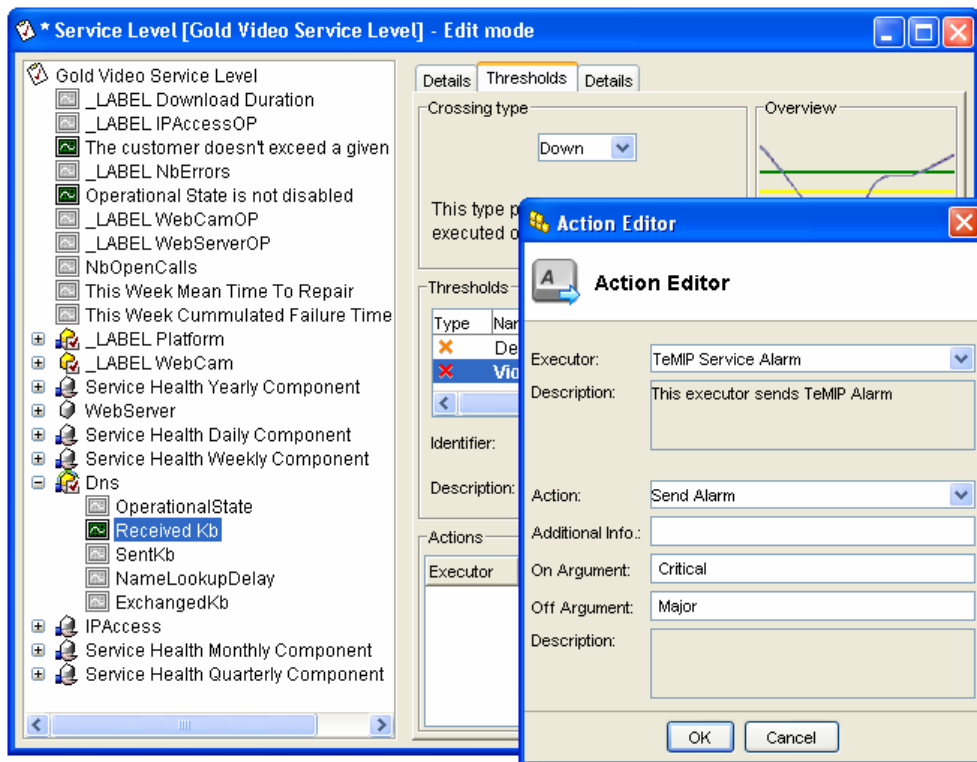

2.1.2 SQM TeMIP Gateway Entity Model

The SQM TeMIP Gateway exports three similar entity model hierarchies in TeMIP. One global class is defined for each SQM SLA type, as follows:

- The *SERVICE_CUSTOMER* global class on which SQM degradation and violation events from *customer* SLA are targeted.

Figure 4 *SERVICE_CUSTOMER* entity hierarchy

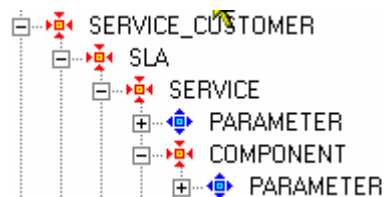

- The *SERVICE_OPERATION* global class on which SQM degradation and violation events from *operational* SLA and the *default* SLA are targeted.

Figure 5 *SERVICE_OPERATION* entity hierarchy

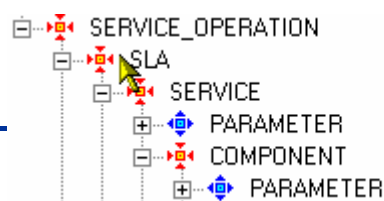

- The *SERVICE_ROOT* global class on which SQM degradation and violation events from the *default* SLA are targeted.

Figure 6 *SERVICE_ROOT* entity hierarchy

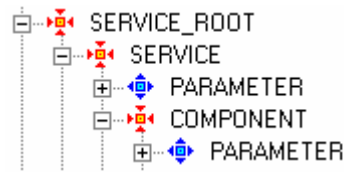

Managed objects of the *SERVICE_CUSTOMER* class, *SERVICE_OPERATION*, represent instances of customer SLA in SQM, operational SLA.

Managed objects of the *SLA* child class, respectively *SERVICE* and *COMPONENT*, represent instances of SLA in SQM, respectively service, and component.

Managed objects of the *PARAMETER* class, child class of *SERVICE*, respectively *COMPONENT*, represent parameters of corresponding service instance in SQM, respectively, of service component instance.

The managed object instance name is built with the name of the SQM instance, and not the label.

2.1.3 TeMIP Alarm Mapping from SQM Event

This section explains how OSI alarms are mapped in TeMIP from SQM violation and degradation events.

2.1.3.1 OSI Alarm on Parameter Threshold Crossing

An OSI alarm on Parameter Threshold Crossing is generated when a Service Level Objective associated to a monitored parameter is crossed.

OSI Alarm Managed Object

The OSI alarm managed object field is retrieved in the corresponding SQM event. It is given by the *Entity Name*, the *SLA Name*, the *SI Name*, the *SCI Name* and the *Parameter Name* attributes of the crossed threshold.

For a Customer SLA, here is an example of the managed object:

```

SERVICE_CUSTOMER entityName SLA slaName SERVICE siName
(COMPONENT sciName -if not null-) PARAMETER
sloMntrdParamName
  
```

For an Operational SLA, here is an example for the managed object:

```

SERVICE_OPERATION entityName SLA slaName SERVICE siName
(COMPONENT sciName -if not null-) PARAMETER
sloMntrdParamName
  
```

OSI Alarm Severity

The OSI alarm severity is retrieved in the corresponding SQM event. It is given by the *On Argument* or *Off Argument* optional attributes of the crossed threshold action executor.

If the threshold crossing corresponds to a Quality of Service decreasing, the severity is indicated by the *On Argument* (*action.on*) attribute.

If the threshold crossing corresponds to a Quality of Service increasing, the severity is indicated by the *Off Argument* (*action.off*) attribute.

If the threshold crossing corresponds to a Quality of Service decreasing, and the crossed threshold is a violation threshold, the OSI alarm severity is always mapped to **Critical** even if the *On Argument (action.on)* attribute is filled.

The following diagram shows an example with three thresholds.

Figure 7 Threshold Crossing SNMP Traps severity

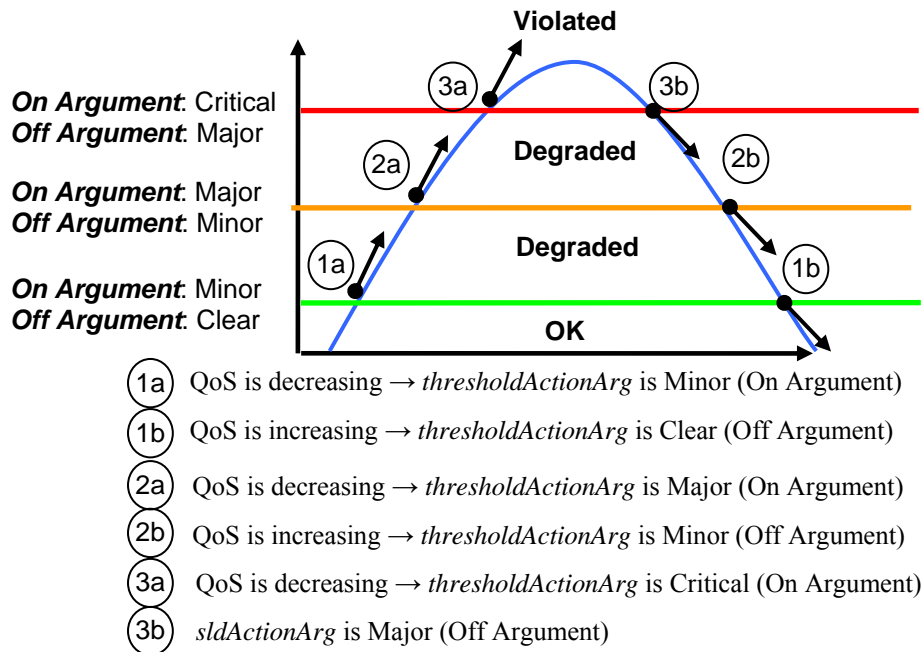

If no *On Argument* (or *Off Argument*) is provided, the OSI alarm severity is deduced from the crossed threshold *eventType*:

- If the crossed threshold is a violation threshold and the Quality of Service is decreasing, the OSI alarm severity is mapped to **Critical**.
- If the crossed threshold is a violation threshold and the Quality of Service is increasing, the OSI alarm severity is mapped to **Major**.
- If the crossed threshold is a degradation threshold, the OSI alarm severity is mapped to the default severity: **Major**.
- If the parameter is no longer degraded, the SQM TeMIP Gateway issues a **Clear** severity OSI alarm.

The available severities are:

- Critical
- Major
- Minor
- Warning
- Clear

Other severities are not allowed and are ignored by the SQM TeMIP Gateway.

Important

The severities are case sensitive. The first letter must always be in upper case.

OSI Alarm Event Type and Probable Cause

The Event Type OSI alarm field is set to **QualityOfServiceAlarm** and the Probable Cause OSI alarm field is set to **ThresholdCrossed**.

Other TeMIP Alarm Additional Text mapping

The following table lists the mapping between the SQM events fields and the OSI alarm fields.

Table 1 TeMIP Alarm Additional Text mapping

SQM Object	TeMIP Alarm Additional Information Fields
Customer label	Entity Label
Customer name	Entity Name
Type (Customer, Operation)	Entity Type
Number of impacted SLAs	Number of Impacted SLAs ¹
Parameter Value	Parameter Measure
-	Root Problem ²
Component Definition label	Component Definition Label
Component Definition name	Component Definition Name

¹ Only for Root Alarm

² True when Root Alarm

SQM Object	TeMIP Alarm Additional Information Fields
Component label	Service Component Label
Component name	Service Component Name
Service or Component flag	Service Component Type
Service Definition label	Service Definition Label
Service Definition name	Service Definition Name
Service label	Service Label
Service name	Service Name
SLA label	SLA Label
SLA name	SLA Name
SLA Monitoring type	SLA Monitoring Type
Service Level label	Service Level Label
Service Level name	Service Level Name
Component Service Level label	Component Service Level Label
Component Service Level name	Component Service Level Name
Crossing Type	Crossing Type
Service Level Objective label	Service Level Objective Label
Service Level Objective name	Service Level Objective Name
Parameter label	Parameter Label
Parameter name	Parameter Name
Parameter datatype	Parameter Type
Threshold Action name	Action Name
Objective Threshold label	Threshold Label
Objective Threshold name	Threshold Name
Threshold Reference Value	Threshold Reference Value
Threshold Action. on or .off field	Action Arg
Acquisition Timestamp	Time Stamp

Example of OSI alarm generated

Figure 8 Threshold Crossing OSI Alarm generated

```
Event: Quality Of Service Alarm
OSI Alarm : failure in the quality of service detected
  Probable Cause = ThresholdCrossed
  Specific Problem = { customerSLA }
  Perceived Severity = Minor
  Monitored Attributes = { ( ( ( SQM_SYSTEM ) , snmpTrapOID ) ,
    ".iso(1).org(3).dod(6).internet(1).private(4).enterprises(1).hp(11).nm(2).openView(17)
    .telco(15).sqmMIB(1).sqmTraps(1).customerParamThresCrossing(2).customerSLADegradationS
    tart(3)" ) ,
    ( ( ( SQM_SYSTEM , SQM , slaTable ) , slaMonitoringType ) , customer ) ,
    ( ( ( SQM_SYSTEM , SQM , sqmTraps , sqmScalars ) , rootCause ) , False ) ,
    ( ( ( SQM_SYSTEM , SQM , serviceTable ) , siName ) , "Paris" ) ,
    ( ( ( SQM_SYSTEM , SQM , serviceTable ) , siLabel ) , "_LABEL Paris" ) ,
    ( ( ( SQM_SYSTEM , SQM , serviceTable ) , siDefName ) , "Video" ) ,
    ( ( ( SQM_SYSTEM , SQM , serviceTable ) , siDefLabel ) , "Video" ) ,
    ( ( ( SQM_SYSTEM , SQM , entityTable ) , entityName ) , "Compaq" ) ,
    ( ( ( SQM_SYSTEM , SQM , entityTable ) , entityLabel ) , "_LABEL Compaq" ) ,
    ( ( ( SQM_SYSTEM , SQM , entityTable ) , entityType ) , customer ) ,
    ( ( ( SQM_SYSTEM , SQM , slaTable ) , slaServiceLevelName ) , "Gold-Video" ) ,
    ( ( ( SQM_SYSTEM , SQM , slaTable ) , slaServiceLevelLabel ) , "Gold Video Service
    Level" ) ,
    ( ( ( SQM_SYSTEM , SQM , slaTable ) , slaName ) , "GoldVideoFR" ) ,
    ( ( ( SQM_SYSTEM , SQM , slaTable ) , slaLabel ) , "_LABEL GoldVideoFR" ) ,
    ( ( ( SQM_SYSTEM , SQM , serviceComponentTable ) , sciName ) , "platform-CamWeb" ) ,
    ( ( ( SQM_SYSTEM , SQM , serviceComponentTable ) , sciLabel ) , "_LABEL
    platform-CamWeb" ) ,
    ( ( ( SQM_SYSTEM , SQM , serviceComponentTable ) , sciDefName ) , "PlatformV" ) ,
    ( ( ( SQM_SYSTEM , SQM , serviceComponentTable ) , sciDefLabel ) , "Platform" ) ,
    ( ( ( SQM_SYSTEM , SQM , serviceComponentTable ) , sciType ) , component ) ,
    ( ( ( SQM_SYSTEM , SQM , sqmTraps , sqmScalars ) , timeStamp ) , Wed Mar 17 09:17:37
    2004 ) ,
    ( ( ( SQM_SYSTEM , SQM , sqmTraps , sqmScalars ) , addText ) , "ADD INFO DEG MINOR" ) ,
    ( ( ( SQM_SYSTEM , SQM , sqmTraps , sqmScalars ) , measuredParamValue ) , "41" ) ,
    ( ( ( SQM_SYSTEM , SQM , sloTable ) , sloComponentServiceLevelName ) , "PLATFORMV6843" ) ,
    ( ( ( SQM_SYSTEM , SQM , sloTable ) , sloComponentServiceLevelLabel ) , "_LABEL
    Platform" ) ,
    ( ( ( SQM_SYSTEM , SQM , sloTable ) , sloName ) , "CPULoadBelow" ) ,
    ( ( ( SQM_SYSTEM , SQM , sloTable ) , sloLabel ) , "CPU Load below 60 percent" ) ,
    ( ( ( SQM_SYSTEM , SQM , sloTable ) , sloMntrdParamName ) , "CPULoad" ) ,
    ( ( ( SQM_SYSTEM , SQM , sloTable ) , sloMntrdParamLabel ) , "_LABEL CPULoad" ) ,
    ( ( ( SQM_SYSTEM , SQM , sloTable ) , sloMntrdParamType ) , global ) ,
    ( ( ( SQM_SYSTEM , SQM , sloTable ) , sloCrossingType ) , up ) ,
    ( ( ( SQM_SYSTEM , SQM , sloTable ) , sloThreshName ) , "degradation_2" ) ,
    ( ( ( SQM_SYSTEM , SQM , sloTable ) , sloThreshLabel ) , "_LABEL Level 0" ) ,
    ( ( ( SQM_SYSTEM , SQM , sloTable ) , sloThreshReferenceValue ) , "40" ) ,
    ( ( ( SQM_SYSTEM , SQM , sloTable ) , sloThreshActionName ) , "EmitTrap" ) ,
    ( ( ( SQM_SYSTEM , SQM , sqmTraps , sqmScalars ) , thresholdActionArg ) , "Minor" ) }
  Additional Text = "This trap is sent each time a parameter crosses the associated threshold and that the
  event leads to the degradation of Customer SLA(s).
  @@SLAMonitoringType customer!!ServiceName Paris!!ServiceLabel _LABEL
  Paris!!ServiceDefinitionName Video!!ServiceDefinitionLabel Video!!ServiceComponentName
  platform-CamWeb!!ServiceComponentLabel _LABEL platform-CamWeb!!ServiceComponentType
  component!!ComponentDefinitionName PlatformV!!ComponentDefinitionLabel
  Platform!!TimeStamp Wed, Mar 17, 2004 09:17:37 AM!!ParameterMeasure 41!!RootProblem
  False!!NumberOfImpactedSLA !!AdditionalText ADD INFO DEG MINOR!!ServiceLevelName
  Gold-Video!!ServiceLevelLabel Gold Video Service Level!!SLAName GoldVideoFR!!SLALabel
  _LABEL GoldVideoFR!!EntityName Compaq!!EntityLabel _LABEL Compaq!!EntityType
  customer!!ComponentServiceLevelName PLATFORMV6843!!ComponentServiceLevelLabel _LABEL
  Platform!!ServiceLevelObjectiveName CPULoadBelow!!ServiceLevelObjectiveLabel CPU Load
  below 60 percent!!ParameterName CPULoad!!ParameterLabel _LABEL CPULoad!!ParameterType
  global!!CrossingType up!!ThresholdName degradation_2!!ThresholdLabel _LABEL Level
  0!!ThresholdReferenceValue 40!!ActionName EmitTrap!!ActionArg Minor##"
  Additional Information = { (
    information = {
      enterprise = ".iso(1).org(3).dod(6).internet(1).private(4).enterprises(1).hp(11).nm(2).openView
      (17).telco(15).sqmMIB(1).sqmTraps(1).customerParamThresCrossing(2)",
      agent-address = 10.1.1.53,
      timestamp = 0,
      community-name = "public",
      trap-id = ".iso(1).org(3).dod(6).internet(1).private(4).enterprises(1).hp(11).nm(2).openView
      (17).telco(15).sqmMIB(1).sqmTraps(1).customerParamThresCrossing(2).customerSLADegr
      adationStart(3)" ) ,
      significance = True } }
  Managed Object = SERVICE_CUSTOMER cha_ns:Compaq SLA "GoldVideoFR" SERVICE "Paris" COMPONENT
  "platform-CamWeb" PARAMETER "CPULoad"
  Event Type = QualityofServiceAlarm
  Event Time = Wed Mar 17 10:17:39 2004
```

2.1.3.2 OSI Alarms on Service Objective Status Changed

An OSI alarm on Service Objective Status Changed is generated when an SLA, Service Instance (SI) or Service Component Instance (SCI) status has changed.

This OSI alarm may be reported at the *COMPONENT*, *SERVICE* or *SLA* levels. It is never reported at *PARAMETER* level.

OSI Alarm Managed Object

The OSI alarm managed object field is retrieved in the corresponding SQM event. It is given by the *Entity Name*, *SLA Name*, *SI Name* and *SCI Name* attributes of the objective status.

For a Customer SLA, here is an example of the managed object:

```
SERVICE_CUSTOMER entityName SLA slaName (SERVICE siName  
-if not null-) (COMPONENT sciName -if not null-)
```

For an Operational SLA, here is an example for the managed object:

```
SERVICE_OPERATION entityName SLA slaName (SERVICE  
siName -if not null-) (COMPONENT sciName -if not null-)
```

OSI Alarm Severity

The OSI alarm is based on the value of the Service Objective Status, as reported by OpenView SQM.

The SQM SNMP Action Executor defines two local fields, which are used to define the OSI alarm severity.

- If the Objective Status is less than the ObjectiveStatusViolationLevel, the OSI Alarm severity is set to **Critical**.
- If the Objective Status is greater than or equal to the ObjectiveStatusViolationLevel, and less than the ObjectiveStatusDegradationLevel, the OSI Alarm severity is set to **Major**.
- If the Objective Status is greater than or equal to the ObjectiveStatusDegradationLevel, the OSI Alarm severity is set to **Clear**.

OSI Alarm Event Type and Probable Cause

The Event Type OSI alarm field is set to **QualityOfServiceAlarm** and the Probable Cause OSI alarm field is set to **ThresholdCrossed**.

Other OSI Alarm fields mapping

The following table lists the mapping between the SQM event fields and the OSI alarm fields.

Table 2 Other OSI Alarm fields mapping

SQM Object	TeMIP Alarm Additional Information Fields
Component Objective Status	Objective Status Value
SLA Objective Status Value	SLA Objective Status Value
Previous Component Objective Status Value	Previous Objective Status Value
Previous SLA Objective Status Value	Previous SLA Objective Status Value

SQM Object	TeMIP Alarm Additional Information Fields
Customer label	Entity Label
Customer name	Entity Name
Type (Customer, Operation)	Entity Type
Component Definition label	Component Definition Label
Component Definition name	Component Definition Name
Component label	Service Component Label
Component name	Service Component Name
Service or Component flag	Service Component Type
Service Definition label	Service Definition Label
Service Definition name	Service Definition Name
Service label	Service Label
Service name	Service Name
SLA label	SLA Label
SLA name	SLA Name
SLA Monitoring type	SLA Monitoring Type
Acquisition Timestamp	Time Stamp

Example of OSI alarm generated

Figure 9 Objective Status OSI Alarm generated

```
SERVICE_CUSTOMER cha_ns:HP SLA "BronzeVideoFR"
On director: cha_ns:temip.charon_director
AT Wed Mar 17 10:30:35 2004 NOTIFICATION EVENTS

Event: Quality Of Service Alarm
OSI Alarm : failure in the quality of service detected
  Probable Cause = ThresholdCrossed
  Specific Problem = { customerService }
  Perceived Severity = Critical
  Monitored Attributes = { ( ( ( SQM_SYSTEM ) , snmpTrapOID ) ,
    ".iso(1).org(3).dod(6).internet(1).private(4).enterprises(1).hp(11).nm(2).openView(17)
    .telco(15).sqmMIB(1).sqmTraps(1).customerSrvObjStatus(4).customerServiceObjectiveViola
    tion(1)" ) ,
    ( ( ( SQM_SYSTEM, SQM, slaTable ) , slaMonitoringType ) , customer ) ,
    ( ( ( SQM_SYSTEM, SQM, slaTable ) , slaName ) , "BronzeVideoFR" ) ,
    ( ( ( SQM_SYSTEM, SQM, slaTable ) , slaLabel ) , "_LABEL_BronzeVideoFR" ) ,
    ( ( ( SQM_SYSTEM, SQM, entityType ) , entityType ) , "HP" ) ,
    ( ( ( SQM_SYSTEM, SQM, entityType ) , entityType ) , "_LABEL_HP" ) ,
    ( ( ( SQM_SYSTEM, SQM, entityType ) , entityType ) , customer ) ,
    ( ( ( SQM_SYSTEM, SQM, sqmTraps, sqmScalars ) , timeStamp ) , Wed Mar 17 09:30:32
    2004 ) ,
    ( ( ( SQM_SYSTEM, SQM, sqmTraps, sqmScalars ) , previousStatus ) , 100 ) ,
    ( ( ( SQM_SYSTEM, SQM, sqmTraps, sqmScalars ) , currentStatus ) , 0 ) }
  Additional Text = "This trap is sent each time a Service Objective Status indicates a violation of a
  SLA/SI/SCI.
  @@SLAMonitoringType customer!!ServiceName !!ServiceLabel !!ServiceDefinitionName
  !!ServiceDefinitionLabel !!ServiceComponentName !!ServiceComponentLabel
  !!ServiceComponentType !!ComponentDefinitionName !!ComponentDefinitionLabel !!SLAName
  BronzeVideoFR!!SLALabel _LABEL_BronzeVideoFR!!EntityName HP!!EntityLabel _LABEL
  HP!!EntityType customer!!TimeStamp Wed, Mar 17, 2004 09:30:32
  AM!!PreviousSLAObjectiveStatusValue 100!!SLAObjectiveStatusValue 0##"
  Additional Information = { ( (
    information = {
      enterprise = ".iso(1).org(3).dod(6).internet(1).private(4).enterprises(1).hp(11).nm(2).openView
      (17).telco(15).sqmMIB(1).sqmTraps(1).customerSrvObjStatus(4)" ,
      agent-address = 10.1.1.53,
      timestamp = 0,
      community-name = "public",
      trap-id = ".iso(1).org(3).dod(6).internet(1).private(4).enterprises(1).hp(11).nm(2).openView
      (17).telco(15).sqmMIB(1).sqmTraps(1).customerSrvObjStatus(4).customerServiceObject
      iveViolation(1)" ) ,
      significance = True } ) }
  Managed Object = SERVICE_CUSTOMER cha_ns:HP SLA "BronzeVideoFR"
  Event Type = QualityOfServiceAlarm
  Event Time = Wed Mar 17 10:30:34 2004
```

2.1.3.3 Root Alarm

The violation or the degradation events may impact several customers or operation SLAs. This OSI alarm called the root alarm is generated only if the violation or the degradation impacts several customers or SLAs and if the Component Instance impacted is a shared component between Services Instances.

This alarm keeps track of the root of the degradation or violation, and includes the number of impacted SLAs.

Note

If only one SLA/Customer is impacted, only one alarm is generated.

OSI Alarm Managed Object

The OSI alarm managed object field for the root alarm is retrieved in the corresponding SQM event. It is given by the *SCI Name* and the *Parameter Name* attributes of the crossed threshold.

For the root alarm, here is an example of the managed object:

```
SERVICE_ROOT defaultSLA SERVICE defaultSI (COMPONENT
sciName -if not null-) PARAMETER sloMntrdParamName
```

OSI Alarm Event Type and Probable Cause

The Event Type OSI alarm field is set to **QualityOfServiceAlarm** and the Probable Cause OSI alarm field is set to **ThresholdCrossed**.

Other OSI Alarm fields mapping

The following table lists the mapping between the SQM event fields and the OSI alarm fields for a root alarm.

Table 3 Other OSI Alarm fields mapping

SQM Object	TeMIP Alarm Additional Information Fields
Number of impacted SLAs	Number of Impacted SLAs ³
ParameterValue	Parameter Measure
True	Root Problem ⁴
Component Definition label	Component Definition Label
Component Definition name	Component Definition Name
Component label	Service Component Label
Component name	Service Component Name
Service or Component flag	Service Component Type
SLA Monitoring type	SLA Monitoring Type
Component Service Level label	Component Service Level Label
Component Service Level name	Component Service Level Name
Crossing Type	Crossing Type
Service Level Objective label	Service Level Objective Label
Service Level Objective name	Service Level Objective Name
Parameter label	Parameter Label
Parameter name	Parameter Name
Parameter datatype	Parameter Type
Threshold Action name	Action Name
Objective Threshold label	Threshold Label
Objective Threshold name	Threshold Name
Threshold Reference Value	Threshold Reference Value
Threshold Action. on or .off field	Action Arg
Acquisition Timestamp	Time Stamp

Example of OSI root alarm generated

In the following example, the root alarm generated concerns a component parameter (Platform-Camweb CPULoad) that is shared between two Service Instances (Video Paris and Video Lyon) and shared between two SLAs.

³ Only for Root Alarm

⁴ True when Root Alarm

Figure 10 OSI Root Alarm Generated

```

TelMIP>
!!!!!!!!!!!!!! Alarm, Thu, Mar 18, 2004 10:21:48 AM !!!!!!!!!!!!!!! [1]
Domain: cha_ns::SQM_SYSTEM_domain                               Severity: Minor
Notification Entity: SERVICE_ROOT cha_ns::defaultSLA SERVICE "defaultSI" COMPONENT "platform-CamWeb" PARAMETER "CPULoad"
Event Source: SERVICE_ROOT cha_ns::defaultSLA SERVICE "defaultSI" COMPONENT "platform-CamWeb" PARAMETER "CPULoad"
Event: Quality Of Service Alarm
OSI Alarm : failure in the quality of service detected
    Probable Cause = ThresholdCrossed
    Specific Problem = { customerSLA }
    Perceived Severity = Minor
    Monitored Attributes = { ( ( ( SQM_SYSTEM ), snmpTrapOID ),
        ".iso(1).org(3).dod(6).internet(1).private(4).enterprises(1).hp(11).nm(2).openView(17).telco(15).sqmMIB(1).sqmTraps(1).customerParamThresCrossing(2).customerSLADegradationStart(3)" ),
        ( ( ( SQM_SYSTEM, SQM, slaTable ), slaMonitoringType ), customer ),
        ( ( ( SQM_SYSTEM, SQM, sqmTraps, sqmScalars ), impactedSLANumber ), 2 ),
        ( ( ( SQM_SYSTEM, SQM, sqmTraps, sqmScalars ), rootCause ), True ),
        ( ( ( SQM_SYSTEM, SQM, serviceTable ), siDefName ), "Video" ),
        ( ( ( SQM_SYSTEM, SQM, serviceTable ), siDefLabel ), "Video" ),
        ( ( ( SQM_SYSTEM, SQM, serviceComponentTable ), sciName ), "platform-CamWeb" ),
        ( ( ( SQM_SYSTEM, SQM, serviceComponentTable ), sciLabel ), "_LABEL platform-CamWeb" ),
        ( ( ( SQM_SYSTEM, SQM, serviceComponentTable ), sciDefName ), "PlatformV" ),
        ( ( ( SQM_SYSTEM, SQM, serviceComponentTable ), sciDefLabel ), "Platform" ),
        ( ( ( SQM_SYSTEM, SQM, serviceComponentTable ), sciType ), component ),
        ( ( ( SQM_SYSTEM, SQM, sqmTraps, sqmScalars ), timeStamp ), Thu, Mar 18, 2004 09:21:45 AM ),
        ( ( ( SQM_SYSTEM, SQM, sqmTraps, sqmScalars ), addText ), "ADD INFO DEG MINOR" ),
        ( ( ( SQM_SYSTEM, SQM, sqmTraps, sqmScalars ), measuredParamValue ), "41" ),
        ( ( ( SQM_SYSTEM, SQM, sloTable ), sloComponentServiceLevelName ), "PLATFORMV6843" ),
        ( ( ( SQM_SYSTEM, SQM, sloTable ), sloComponentServiceLevelLabel ), "_LABEL Platform" ),
        ),
        ( ( ( SQM_SYSTEM, SQM, sloTable ), sloName ), "CPULoadBelow" ),
        ( ( ( SQM_SYSTEM, SQM, sloTable ), sloLabel ), "CPU Load below 60 percent" ),
        ( ( ( SQM_SYSTEM, SQM, sloTable ), sloMntrdParamName ), "CPULoad" ),
        ( ( ( SQM_SYSTEM, SQM, sloTable ), sloMntrdParamLabel ), "_LABEL CPULoad" ),
        ( ( ( SQM_SYSTEM, SQM, sloTable ), sloMntrdParamType ), global ),
        ( ( ( SQM_SYSTEM, SQM, sloTable ), sloCrossingType ), up ),
        ( ( ( SQM_SYSTEM, SQM, sloTable ), sloThreshName ), "degradation_2" ),
        ( ( ( SQM_SYSTEM, SQM, sloTable ), sloThreshLabel ), "_LABEL Level 0" ),
        ( ( ( SQM_SYSTEM, SQM, sloTable ), sloThreshReferenceValue ), "40" ),
        ( ( ( SQM_SYSTEM, SQM, sloTable ), sloThreshActionName ), "EmitTrap" ),
        ( ( ( SQM_SYSTEM, SQM, sqmTraps, sqmScalars ), thresholdActionArg ), "Minor" ) }
    Additional Text = "This trap is sent each time a parameter crosses the associated threshold and that the event leads to the degradation of Customer SLA(s).
@@SLAMonitoringType customer!!ServiceName !!ServiceLabel !!ServiceDefinitionName
Video!!ServiceDefinitionLabel Video!!ServiceComponentName
platform-CamWeb!!ServiceComponentLabel _LABEL platform-CamWeb!!ServiceComponentType
component!!ComponentDefinitionName PlatformV!!ComponentDefinitionLabel
Platform!!TimeStamp Thu Mar 18 09:21:45 2004!!ParameterMeasure 41!!RootProblem
True!!NumberOfImpactedSLA 2!!AdditionalText ADD INFO DEG MINOR!!ServiceLevelName
!!ServiceLevelLabel !!SLAName !!SLALabel !!EntityName !!EntityLabel !!EntityType
!!ComponentServiceLevelName PLATFORMV6843!!ComponentServiceLevelLabel _LABEL
Platform!!ServiceLevelObjectiveName CPULoadBelow!!ServiceLevelObjectiveLabel CPU Load
below 60 percent!!ParameterName CPULoad!!ParameterLabel _LABEL CPULoad!!ParameterType
global!!CrossingType up!!ThresholdName degradation_2!!ThresholdLabel _LABEL Level
0!!ThresholdReferenceValue 40!!ActionName EmitTrap!!ActionArg Minor##"
    Additional Information = { (
        information = {
            enterprise = ".iso(1).org(3).dod(6).internet(1).private(4).enterprises(1).hp(11).nm(2).openView(17).telco(15).sqmMIB(1).sqmTraps(1).customerParamThresCrossing(2)",
            agent-address = 10.1.1.53,
            timestamp = 0,
            community-name = "public",
            trap-id = ".iso(1).org(3).dod(6).internet(1).private(4).enterprises(1).hp(11).nm(2).openView(17).telco(15).sqmMIB(1).sqmTraps(1).customerParamThresCrossing(2).customerSLADegradationStart(3)" ),
            significance = True ) }
    Managed Object = SERVICE_ROOT cha_ns::defaultSLA SERVICE "defaultSI" COMPONENT "platform-CamWeb" PARAMETER "CPULoad"
    Event Type = QualityofServiceAlarm
    Event Time = Thu, Mar 18, 2004 10:21:46 AM

```

2.1.3.4 Fan-Out Processing

The SQM TeMIP Gateway generates as many OSI alarms on service, component and parameter as there are impacted customers and operation SLAs, along with the related root alarm.

This processing is controlled by the fan-out local field in the Central Repository (please refer to the *OpenView SQM Action Executor for SNMP User's Guide* for more information on this field), and is called the alarming fan-out.

When the alarming fan-out feature is disabled, only the root alarm is generated.

Note

By default, the Fan-Out processing is enabled.

2.1.3.5 OSI Alarm on SQM Service Compliance Event

The SQM TeMIP Gateway performs a similar mapping for the OpenView SQM compliance events. The Compliance OSI alarm is mapped from OpenView SQM compliance degradation and violation events.

The processing of Compliance events in the SQM TeMIP Gateway can be disabled. An SNMP Action Executor local field called «*ComplianceEnabled*» in the Central Repository controls this processing. Please refer to the *OpenView SQM Action Executor for SNMP User's Guide*.

Note

By default, compliance events are not processed.

Compliance OSI alarms can be reported on parameter threshold crossing and on Service Objective Status changes. By default, OSI alarms are reported only on parameter threshold crossing. An SNMP Action Executor local field in the Central Repository called «*ComplianceMapping*» controls this processing. Please refer to the *OpenView SQM Action Executor for SNMP User's Guide*.

2.1.4 Displaying Alarms

Once the SQM TeMIP Gateway is correctly configured (refer to Chapter 4 **Error! Reference source not found.**), the TeMIP Client Alarm Handling is ready to display the generated alarms.

1. Launch the TeMIPSQM.exe located on the desktop.



Important

It is important to launch this executable (TeMIPSQM.exe) in order to have the TeMIP Client and SLA Monitoring UI working together. If you separately launch the TeMIP Client and the SLA Monitoring UI applications, the integration will not work.

2. Select and enable the previously configured operation context.

The TeMIP Client Alarm Handling is now ready to display the alarms coming from SQM.

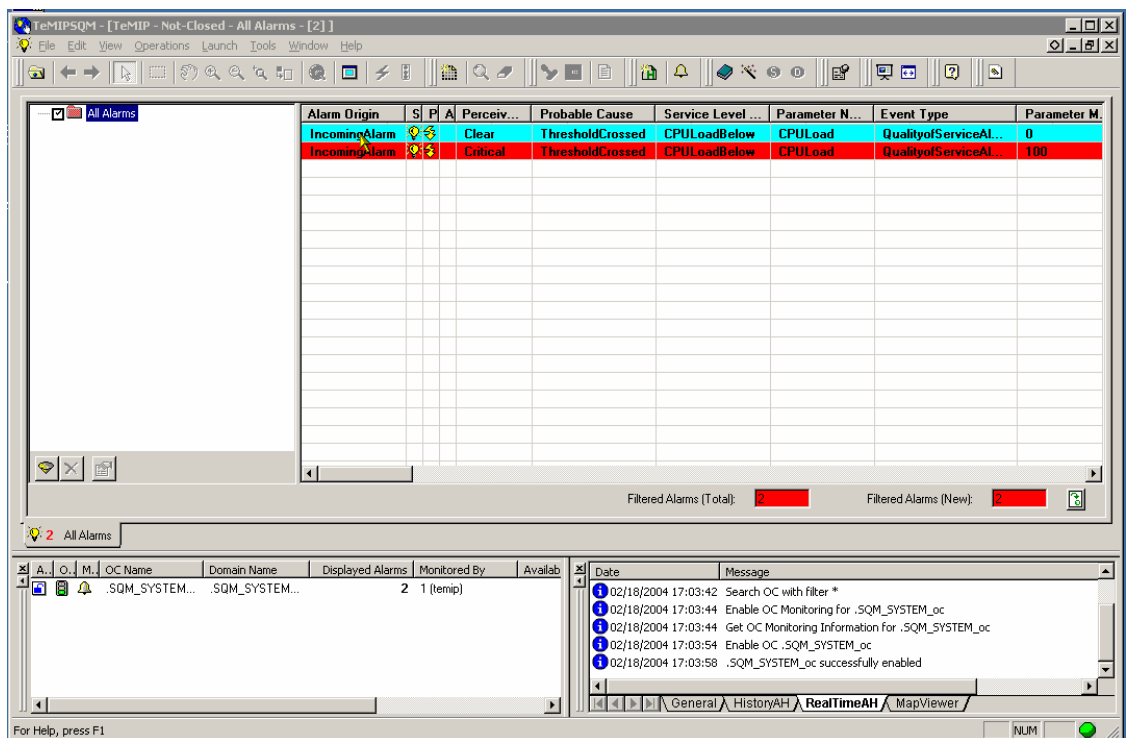

Figure 11 TeMIP Client Alarm Handling displaying 'SQM' alarms

2.2 SQM SLA Monitoring and TeMIP Client Integration

The integration between the SQM SLA Monitoring and the TeMIP Client offers the following possibilities:

From the TeMIP Client, display in the SQM SLA Monitoring SQM object corresponding to an alarm.

From the SLA Monitoring, display in the TeMIP Client the alarms associated to a degraded or a violated SLA, SI or SCI.

From the SLA Monitoring, display in the TeMIP Client the alarms associated to a Parameter Threshold crossing.

2.2.1 From TeMIP Client to SQM SLA Monitoring

To view the impacted object (SLA, SI, SCI, or Parameter) in SQM SLA Monitoring:

1. Click on the MB3 button while selecting an alarm object row.
2. Select the menu option **Find Managed Object in SLA Monitoring**, as shown in the following figure.

Figure 12 Find Managed Object in SLA Monitoring MB3 menu

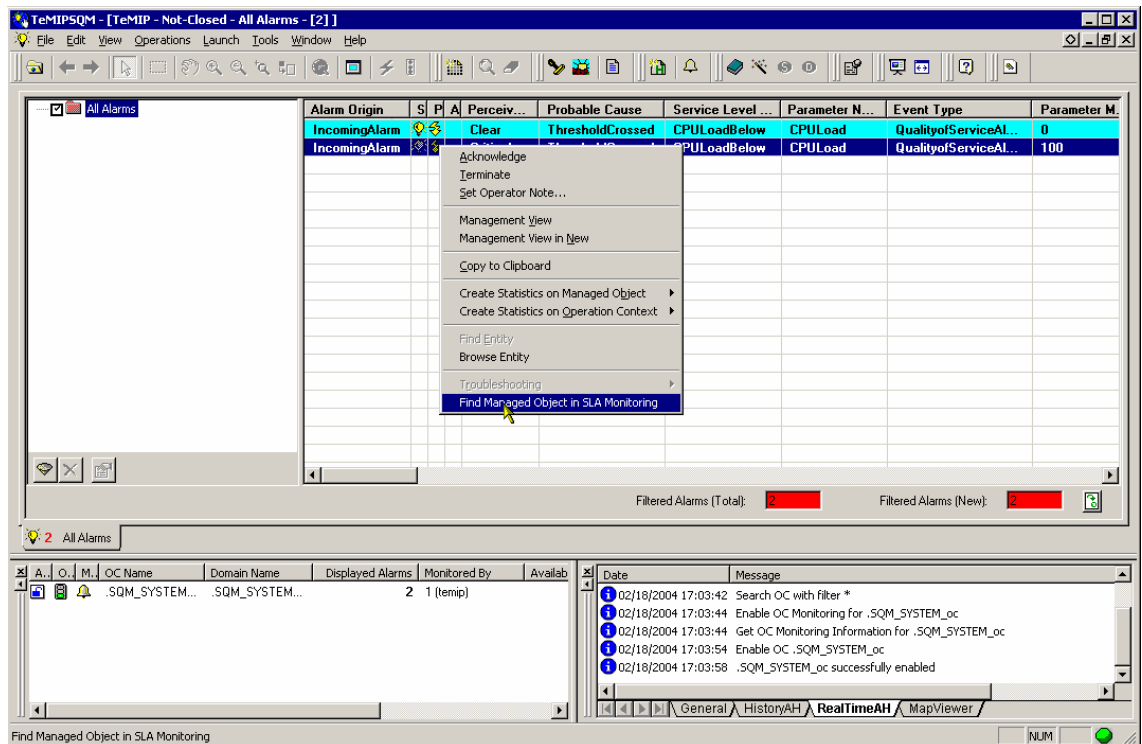

The SQM SLA Monitoring pops-up and shows the impacted Managed Object (SLA, SI, SCI, or Parameter).

2.2.2 From SQM SLA Monitoring to TeMIP Client

To view the associated alarms in TeMIP Client Alarm Handling from an impacted object (SLA, SI, SCI, or Parameter) in the SQM SLA Monitoring:

1. Select this object on the screen.
2. Click on the MB3 button and select the **Display Associated Alarms** menu option.

The same can be achieved by using the **Display Associated Alarms** option, from the **Tools/Launch** menu when selecting an object in the SQM SLA Monitoring.

Figure 13 Display Associated Alarms Menu

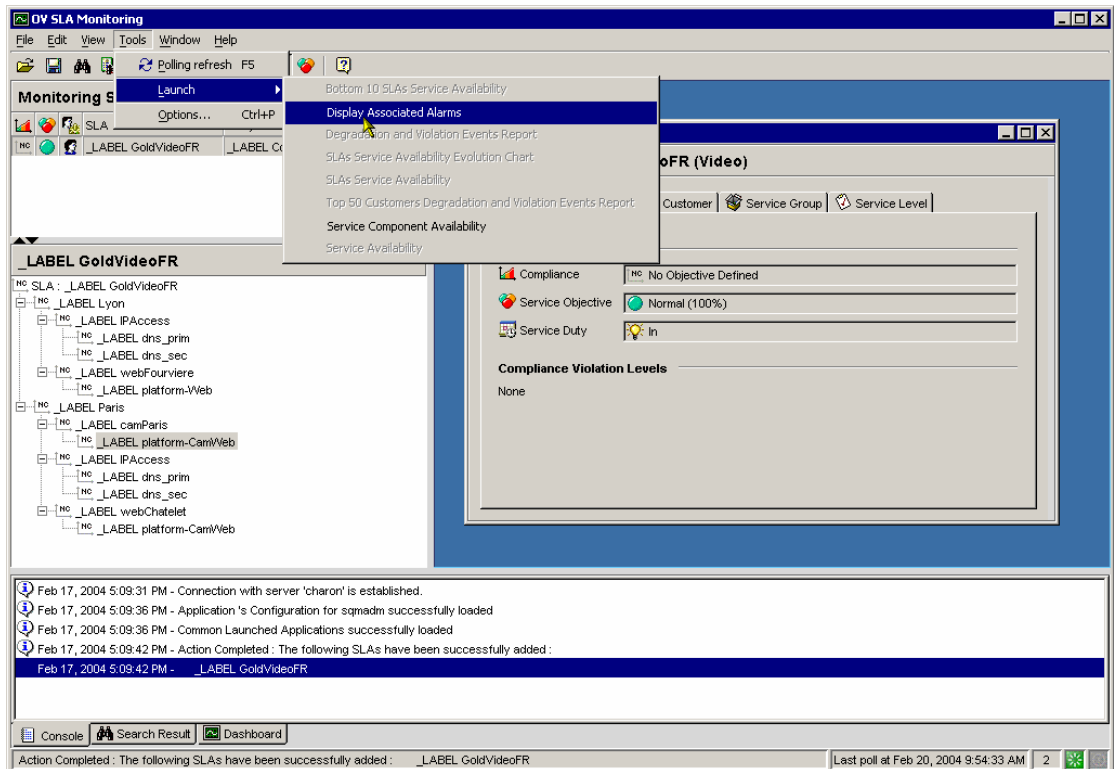

Architecture Overview

The recommended architecture for the SQM TeMIP Gateway Solution is composed of 3 hosts:

- A server running the SQM SLM Primary Server.
- A server running the TeMIP framework.
- A workstation (PC) running the SQM SLA Monitoring and the TeMIP Client.

Figure 14 SQM TeMIP Gateway solution architecture

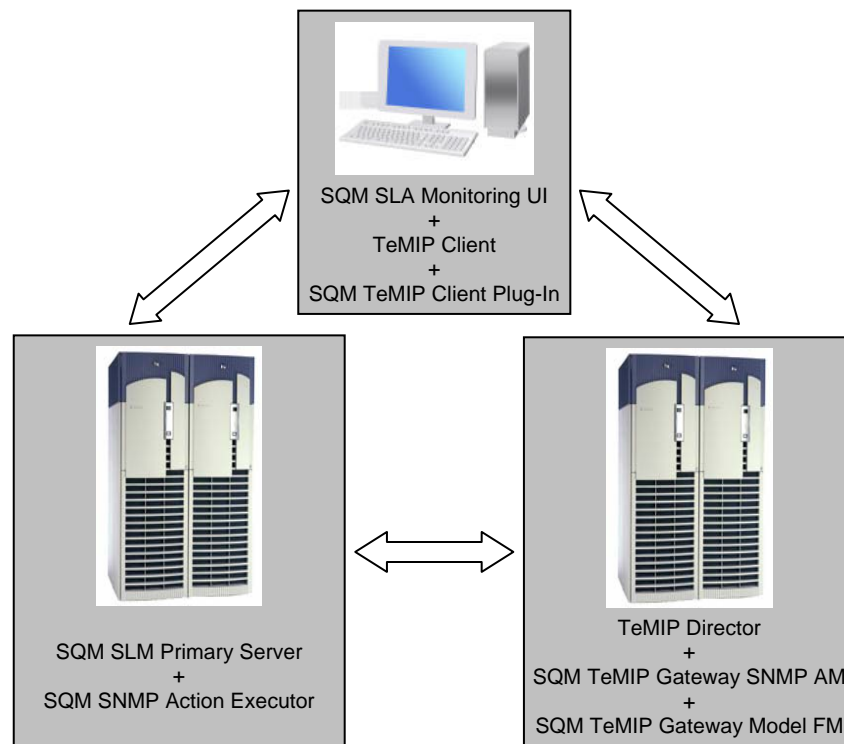

Important

The SQM TeMIP Client Plug-In component requires the SQM SLA Monitoring UI and the TeMIP Client applications to be installed on the same workstation.

Chapter 4

SQM TeMIP Gateway Lifecycle on SQM SLM Primary Server

This section describes the lifecycle of the SQM TeMIP Gateway components running on the SQM SLM Primary Server.

Figure 15 Lifecycle on SQM SLM Primary Host

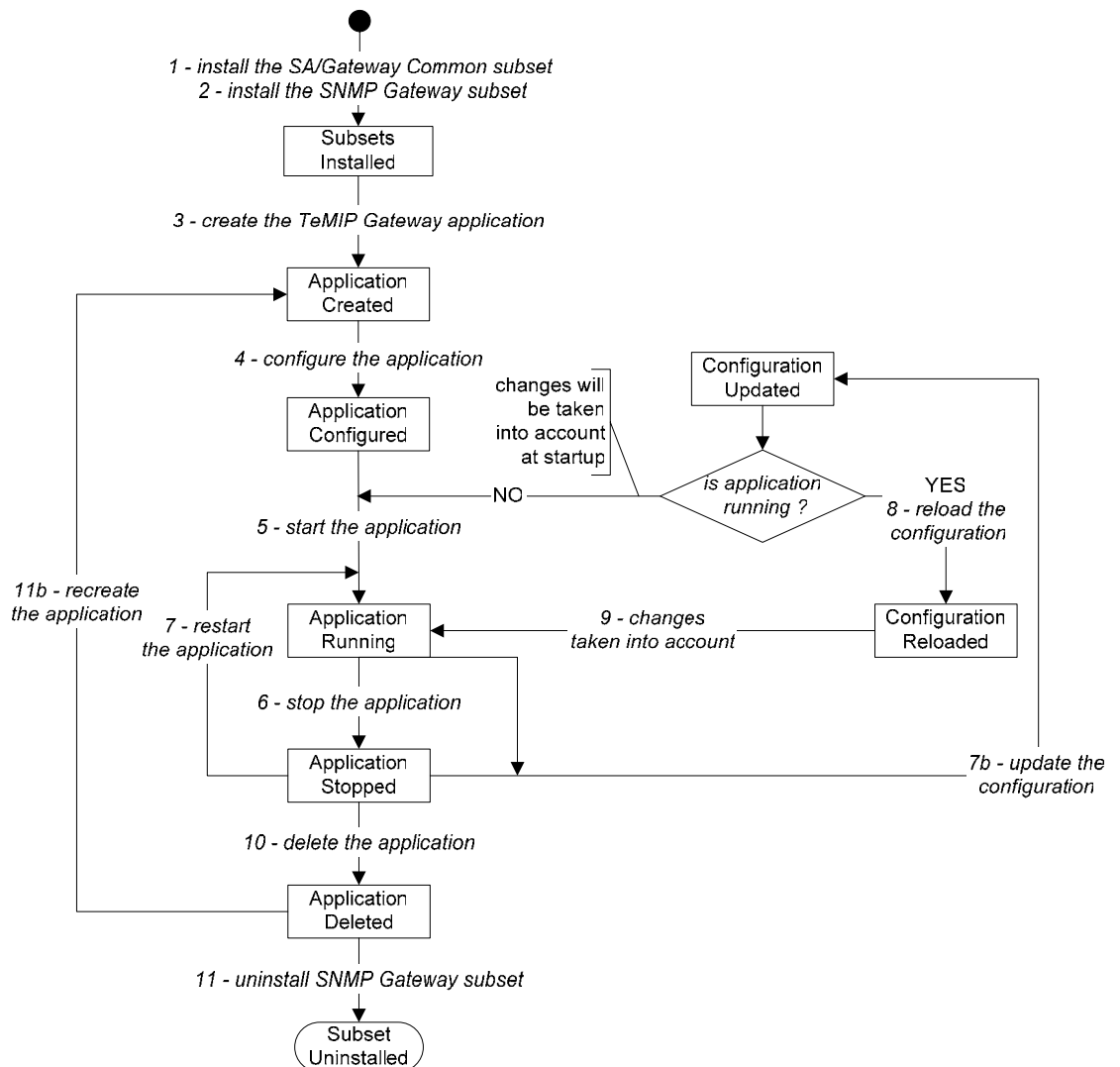

4.1 Software and Hardware Requirements

For software and hardware requirements, refer to the *HP OpenView Service Quality Manager Installation Guide*.

The HP UX machine where SQM V1.2 has been configured, and is running, is called the SQM SLM Primary Server. There is a possibility to have several hosts in a SQM Configuration but this host is the recommended installation target.

On the SQM SLM Primary Server, the SQM TeMIP Gateway solution requires:

- A SQM platform configured and running with the core of the SQM product (refer to the *OpenView SQM Installation Guide*).

4.2 SQM SNMP Action Executor

4.2.1 Installation

Please refer to the *SQM Action Executor for SNMP User's Guide* for more details on how to install the SQM SNMP Action Executor component.

4.2.2 Configuring for the SQM TeMIP Gateway

Create the TeMIP Gateway application

Once the SNMP action executor installed, you have to create the TeMIP Gateway application.

To create the TeMIP Gateway application, perform the following steps:

1. Log on as root
2. Specify the hostname of the TeMIP Director in the TeMIP Gateway repository file (if TeMIP and SQM are running on the same system, you can skip to the next step). To do it update the TeMIP Gateway template repository file located in: **\$TEMIP_SC_HOME/Gateways/SNMP/v1_2/repository/TeMIPGateway_template.exp**
In this file replace the default value (localhost) of the field named “**SNMPManager**” by the hostname of the TeMIP Director.
For instance if the TeMIP hostname is temip.hp.com, the file should contain:
<string name="SNMPManager" value="temip.hp.com"/>
3. Go to the `$TEMIP_SC_HOME/setup/bin` directory
4. Invoke the **temip_sc_setup -addOn TeMIPGateway_v1_2_addOn.tmpl_cfg -appliName <your TeMIP Gateway application name>** command.

Example:

```
# temip_sc_setup -addOn TeMIPGateway_v1_2_addOn.tmpl_cfg  
-appliName TeMIPGateway
```

Once you have completed this procedure, the TeMIP Gateway application is created in the current OpenView SQM platform. This application belongs to the **gateway** director and it has the specified name (the name behind the *-appliName* option).

It is possible to choose a different director name using the **-dirName <director name>** option.

Example:

```
# temip_sc_setup -addOn TeMIPGateway_v1_2_addOn.tmpl_cfg  
-appliName TeMIPGateway -dirName myGtwDirector
```

To check that the application has been correctly created you can perform the command: **temip_sc_show_platform -platform slmv12 -director gateway** (using the *sqmadm* user with all OpenView SQM environment variables set).

For more information, refer to the *HP OpenView Service Quality Manager Administration Guide*.

Configuring the created TeMIP Gateway Application

The configuration of the created TeMIP Gateway is identical to any other SNMP Action Executor (except the Executor Name that is 'TeMIPAlarm'). This configuration is described in the *SQM Action Executor for SNMP User's Guide* document.

4.2.3 Configuring the SLA Administration

In order to set **TeMIPAlarm** as Action Executor for the threshold definitions, a file provided with the SLA Administration has to be modified.

This file is located under the SQM SLA Administration installation folder (by default C:\Program Files\HP OpenView\SQM).

1. Go to the following directory:

```
# cd %TEMIP_SC_HOME%\UI\SLAClient\properties
```

2. Edit the *AvailableActions.xml* file

3. Add the following lines at the end of the file (before the tag `</AvailableActions>`):

```
<Executor executor.name = "TeMIPAlarm" executor.label = "TeMIP  
Service Alarm">  
  <Descr>This executor sends TeMIP Alarm</Descr>  
  <Action action.name = "SendAlarm" action.label = "Send  
Alarm" action.info = "" />  
</Executor>
```

4.2.4 Startup, shutdown and configuration reloading

Please refer to the *SQM Action Executor for SNMP User's Guide* for more details on how to startup, shutdown and configuration reloading of the SQM SNMP Action Executor component.

4.2.5 Uninstallation

Please refer to the *SQM Action Executor for SNMP User's Guide* for more details on how to uninstall the SQM SNMP Action Executor component.

Chapter 5

SQM TeMIP Gateway Lifecycle on TeMIP Director

This section describes the lifecycle of the SQM TeMIP Gateway components running on the TeMIP Director.

Figure 16 Lifecycle on TeMIP Director

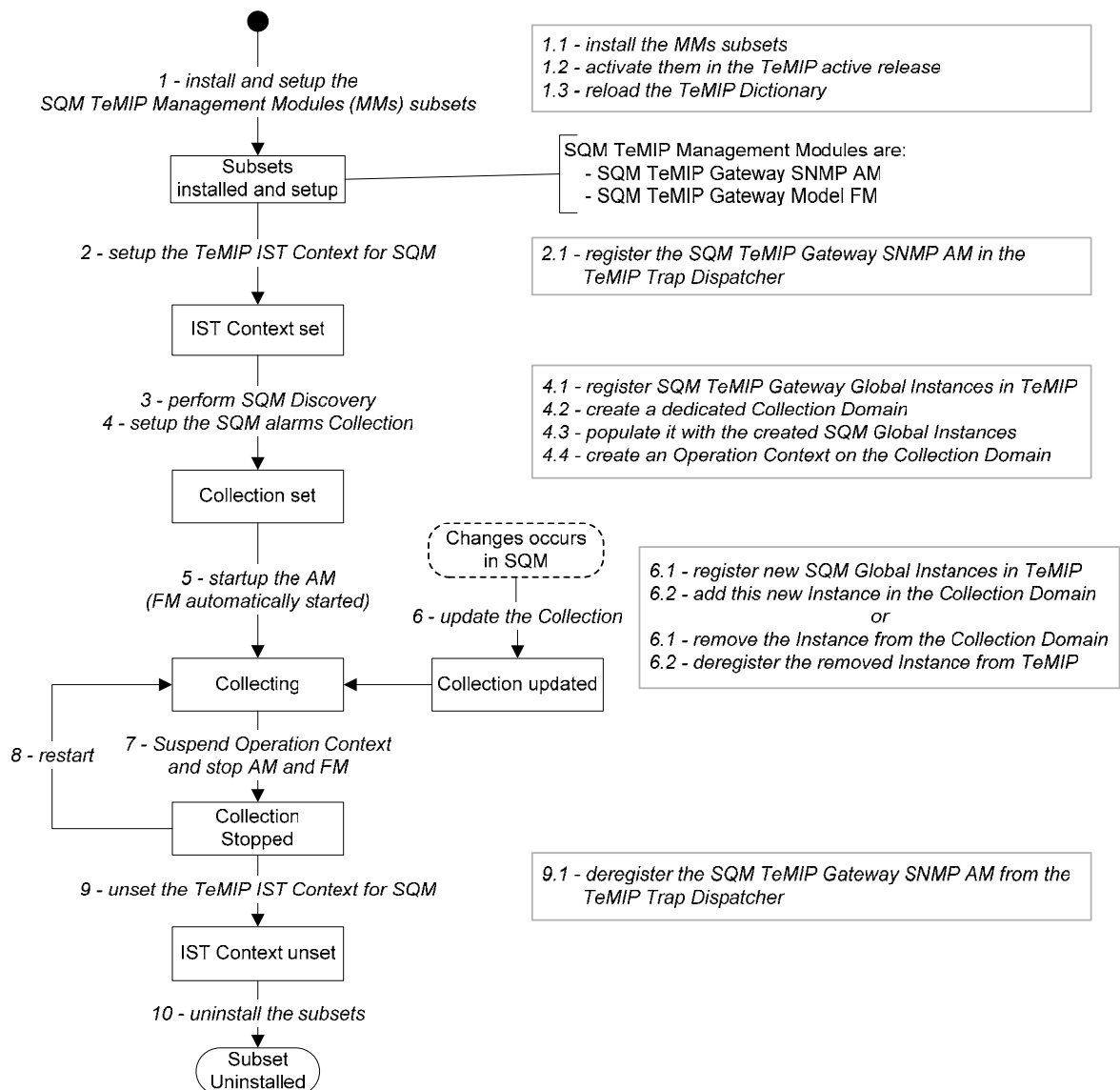

5.1 Software and Hardware Requirements

On the TeMIP Director, the SQM TeMIP Gateway solution requires:

- The TeMIP V5.0 framework on HP-UX server with the TeMIP V5.0 HP-UX server consolidated maintenance release installed and configured (refer to the *OpenView TeMIP Installation Guide*).
- The TeMIP Internet SNMP Toolkit Base V5.0 system (SNMP AM is installed and configured).
- The TeMIP TAL Orbix Server V5.0 must be installed and configured (if the TeMIP Director is also used as TeMIP PM Server).

5.2 SQM TeMIP Gateway Management Modules for TeMIP V5

The SQM TeMIP Gateway Management Modules are:

- The SQM TeMIP Gateway SNMP AM.
- The SQM TeMIP Gateway Model FM.

5.2.1 Installation

Important

You should not install the SQM TeMIP Gateway SNMP AM and Model FM kit on a system configured as a TeMIP client director (PM Server), because this type of director cannot run the SNMP_AM Module.

Important 2

The SQM TeMIP Gateway SNMP AM and Model FM have to be installed on the same system.

Logging On

You must have root privileges to install the SQM TeMIP Gateway Management Modules kit.

You can set the current working directory to the top level (or root) directory using the following command:

```
# cd / [Return]
```

Kit Installation

Note

If the SQM TeMIP Gateway SNMP AM and Model FM kit are already installed, you must remove them before installing a new version.

4. Insert the SQM SAs and Gateways CD-ROM in your CD-ROM drive.
5. Set up your display.
6. Mount the CD-ROM drive on the /cdrom local directory:

```
# mkdir /cdrom [Return]
# /usr/sbin/pfs_mount /cdrom [Return]
```

7. Copy the **ISTRTSQM100.tape.gz** kit in your working directory. This file is located under the following directory:

```
/cdrom/SQM-1.20.00-SAGTW/HP-UX/<subsetname>
```

8. Unzip the tar file in the working directory where the kit file has been copied from the SA and Gateways CDROM:

```
# gunzip ISTRTSQM100.tape.gz [Return]
```

9. Determine the TeMIP active release (TeMIP-Release):

```
# temip_inventory
```

```
Active TeMIP Release: /usr/opt/TeMIPV50
```

```
...
```

10. Install the SQM TeMIP Gateway SNMP AM.

To install it, enter the following commands from the directory in which the file has been decompressed:

```
# swinstall -s /<absolute-path-to-kit>/ISTRTSQM100.tape  
ISTRTSQM100.ISTSQCST100V50H:/usr/opt/<TeMIP-Release> [Return]
```

where:

<TeMIP-Release> represents the root of the TeMIP release tree

<absolute-path-to-kit> represents the full path of the directory where the kit has been copied.

11. Install the SQM TeMIP Gateway Model FM.

To install it, enter the following commands from the directory in which the file has been decompressed:

```
# swinstall -s /<absolute-path-to-kit>/ISTRTSQM100.tape  
ISTRTSQM100.ISTSQMMFM100V50H:/usr/opt/<TeMIP-Release> [Return]
```

where:

<TeMIP-Release> represents the root of the TeMIP release tree

<absolute-path-to-kit> represents the full path of the directory where the kit has been copied.

12. Activate the Management Modules in the TeMIP active release.

To do this, enter the `temip_activate` command with its full path:

```
# /usr/opt/<TeMIP-Release>/temip/bin/temip_activate [Return]
```

where:

<TeMIP-Release> represents the root of the TeMIP release tree

13. Reload the TeMIP dictionary by issuing the following command:

```
Manage > reloaddict mcc 0 [Return]
```

The installation is now complete.

You must now configure the SQM TeMIP Gateway SNMP AM and Model FM.

5.2.2 Configuration

This section explains how to set up the configuration of the SNMP Agent and Trap Dispatcher. It also explains how to register and deregister SQM TeMIP Global Instances in TeMIP and provides explanations on how to start and stop the SQM TeMIP Gateway SNMP AM and Model FM.

Important

Before configuring the SQM TeMIP Gateway SNMP AM and Model FM, ensure that the TeMIP IST is setup and configured (see Appendix C).

5.2.2.1 SNMP Agent Configuration

The AGENT class is a child class of SNMP_CONFIGURATION. This class instance gives a detailed representation of the SNMP agent (description, configuration and characteristics).

The AGENT class attributes can be organized in two major categories:

- SNMP agent attributes (agent name, IP address and so on)
- Managed Entity identifier attributes (SQM_SYSTEM global class instance)

An SQM_SYSTEM AGENT class instance has to be created. Refer to the *HP OpenView TeMIP - Internet SNMP Toolkit (IST) Configuration and Troubleshooting Guide* for details.

The following is given as an example:

```
Register a global class instance
# manage
TeMIP > register SQM_SYSTEM .sqm_system1
Create an SNMP CONFIGURATION
TeMIP > create SNMP_CONFIGURATION <snmp_conf_name> AGENT
SQM_SYSTEM_agent MANAGED ENTITY = SQM_SYSTEM .sqm_system1,
ADDRESS = <IP Address>
```

5.2.2.2 Trap Dispatcher Configuration for the SQM_GTW_AM

The Trap Dispatcher is documented in the *HP OpenView TeMIP - Internet SNMP Toolkit (IST) Configuration and Troubleshooting Guide*.

The use of the Trap dispatcher is mandatory when using an SNMP AM clone as the SQM_GTW_AM. No specific setting is required for the SNMP agent of the remote network element if it is managed from a cloned AM. For each clone, a filter file tells the trap dispatcher to dispatch (or not) an incoming trap, identified by its trap OID, to the matching clone.

SQM_GTW_AM Registration with the Trap Dispatcher

Each clone AM requires owning a UDP port to receive its traps forwarded by the trap dispatcher. The trap dispatcher itself owns the standard SNMP trap UDP port (162), thus the SQM_GTW_AM SINK cannot use this port.

The UDP port value is entered during the registration of the SQM_GTW_AM in the Trap dispatcher. This registration is performed using the following command (with root user account):

```
# ist_setup -m sqm_gtw_am -p <port number> tdregappl
```

The same registration command can be executed through interactive menus of the IST tool setup tool (ist_setup). Please refer to the *HP OpenView TeMIP - Internet SNMP Toolkit (IST) Configuration and Troubleshooting Guide*.

AM Interaction with the Trap Dispatcher

If the SQM_GTW_AM coexists with other SNMP AM clones on the same AM director, Quality of Service (QoS) alarms may appear when several SNMP AM clones are entitled to receive the same SNMP traps. To avoid unnecessary alarms being raised, the following TeMIP Environment Variables are required:

```
IST_EVT_NOLOG_ON_UNKNOWN_ME=ON
IST_EVT_NOLOG_ON_UNKNOWN_ME_SQM_GTW_AM=ON
```

Note that IST_EVT_NOLOG_ON_UNKNOWN_ME_SNMP_AM does not exist.

The purpose of these Environment Variables is explained below. You can also refer to the *HP OpenView TeMIP Internet SNMP Toolkit (IST) Configuration and Troubleshooting Guide*.

The variables can be set using the related UNIX command in the shell where `temip_start` is performed, or they can be set in the following file (edited with the root user):

```
# /var/opt/temip/conf/.temip_config
```

When a trap is handled by several cloned AMs (this is typically the case of all the generic SNMP traps from MIBII) the trap dispatcher ignores which AM manages which network element identified by its IP address. The trap dispatcher systematically forwards the incoming trap towards all the clones that handle it.

Note

If a trap is not managed by any of the clones, it is by default forwarded to the base `SNMP_AM`.

A trap can be dispatched to a Clone AM, while another clone manages its sender network element. In that case an unnecessary alarm is raised. A QoS alarm stating:

The corresponding entity cannot be handled by the AM.

is generated over the `SNMP_CONFIGURATION AGENT` entity of the network element. Since the trap is also properly dispatched to the `SQM_GTW_AM` clone AM that manages the network element, the trap is properly converted to a matching OSI alarm by `SQM_GTW_AM`. To avoid such a misleading QoS alarm, the AM dependent environment variable `IST_EVTNOLOG_ON_UNKNOWN_ME_SQM_GTW_AM` must be set to ON.

The solution to avoid unnecessary QoS alarms over the `SNMP_CONFIGURATION AGENT` TeMIP entities is to set the non AM dependent environment variable `IST_EVTNOLOG_ON_UNKNOWN_ME` to ON. Then, an incoming trap will generate a QoS alarm over the `SNMP_CONFIGURATION` entity if it comes from a network element whose address is not an IP address of a network element managed by any one of all the enrolled `SNMP_AM` clones.

5.2.2.3 Setup of the TeMIP Alarm Collection context

In order to be monitored in TeMIP, SQM customers (used by Customer SLA) or operations (used by operational SLA) must be registered as Global Instances, themselves member of a TeMIP domain.

Thus, the setup of the TeMIP Collection Context consists in the following operations:

- The discovery of the SQM customers and operations.
- The registration of the corresponding TeMIP Global Instances.
- The creation (if needed) of a Collection Domain with an associated Operation Context.
- The declaration of the registered Global Instances as member of the Collection Domain.

To ease these operations, the `'temip_data_load'` tool, delivered with the SQM SNMP Action Executor, aims to:

- Discover the SQM customers and operations
- Generate a TeMIP Command Line file able to:
 - Register the corresponding SQM TeMIP Gateway Global Instances in TeMIP

- Optionally create as Collection Domain and declare the registered Global Instances as member of the created domain

Information

Appendix D explains how to manually register the TeMIP Global Instances.

Using the 'temip_data_load' tool

To use the 'temip_data_load' tool, perform the following operations:

1. Log on as 'sqmadm' user on the SNMP Action Executor host (usually, the SQM SLM Primary Server).
2. Ensure that:
 - the SQM Environment is set
 - the SQM Kernel is running
 - the SQM Service Repository Manager is running
3. Go to the following directory:

```
$STEMIP_SC_HOME/Gateways/SNMP/v1_2/utilities/temip
```

4. Perform the following command:

```
'temip_data_load'
```

Example:

```
> temip_data_load  
Generating TeMIP command file in: /tmp/SQMDataLoad_27744.cmd
```

The generated file looks like:

```
register SERVICE_CUSTOMER Compaq  
register SERVICE_CUSTOMER HP  
register SERVICE_OPERATION MyOperation  
register SERVICE_OPERATION VideoMaintenance  
register SERVICE_ROOT DefaultSLA
```

To create a Collection Domain and declare the registered Global Instances as member of it, replace the step 4 by the following operation:

```
'temip_data_load -temipDomain <SQM_Collection_Domain_name>'
```

Example:

```
> temip_data_load -temipDomain SQMDomain  
Generating TeMIP command file in: /tmp/SQMDataLoad_27758.cmd
```

With the '-temipDomain' option, the generated file looks like:

```
create DOMAIN SQMDomain  
register SERVICE_CUSTOMER Compaq  
create domain SQMDomain member Compaq  
register SERVICE_CUSTOMER HP  
create domain SQMDomain member HP  
register SERVICE_OPERATION MyOperation  
create domain SQMDomain member MyOperation  
register SERVICE_OPERATION VideoMaintenance  
create domain SQMDomain member VideoMaintenance  
register SERVICE_ROOT DefaultSLA  
create domain SQMDomain member DefaultSLA
```

Loading the generated TeMIP Command Line file

To load the TeMIP Command Line file generated by the 'temip_data_load' tool, perform the following operations:

1. Copy the generated file on the TeMIP Director host.

2. Log on as 'temip' user.
3. Perform the following command:

Example:

```
> manage do SQMDataLoad_27758.cmd
```

Creating the Operation Context

In order to collect alarms generated on these instances, an operation context associated to the collection domain must be created and registered.

Here are some recommendations for the OC settings:

Table 4 Recommended Operation Context settings

Property	Value
Similarity Mode	<i>SameProblemType</i>
Severity Propagation Mode	<i>Latest</i>
Reduction Mode	<i>automatic</i>
Automatic Terminate on Clearance	<i>True</i>

Please refer to the OpenView *TeMIP Fault Management User's documentation* for more information.

5.2.3 Starting and Stopping the SQM TeMIP Gateway SNMP AM

To start the SQM TeMIP Gateway SNMP AM application, enter the following command:

```
Manage > start mcc 0 appli SQM_GTW_AM
```

To stop the SQM TeMIP Gateway SNMP AM application, enter the following command:

```
Manage > stop mcc 0 appli SQM_GTW_AM
```

5.2.4 Starting and Stopping the SQM TeMIP Gateway Model FM

To start the SQM TeMIP Gateway Model FM application, enter the following command:

```
Manage > start mcc 0 appli SCGTW_FM
```

To stop the SQM TeMIP Gateway Model FM application, enter the following command:

```
Manage > stop mcc 0 appli SCGTW_FM
```

5.2.5 Uninstallation

Logging On

You must have root privileges to install the SQM TeMIP Gateway Management Modules kit.

You can set the current working directory to the top level (or root) directory using the following command:

```
# cd /
```

Uninstall the SQM TeMIP Gateway SNMP AM

If you need to remove a version of the SNMP or the SQM TeMIP Gateway AM kit from the system, delete the package that was installed.

To delete a package that unloads the customizations contained in AM - use *swremove*, for example:

1. Log in as root user
2. Enter the following commands (subset deletion):

```
# swremove ISTRSQM100.ISTRSQMCST100V50H
```
3. Remove the SQM TeMIP Gateway AM itself (subset deletion):

```
# swremove ISTRSQM100.ISTRSQMAM100V50H
```

Uninstall the SQM TeMIP Gateway Model FM

If you need to remove a version of the SNMP or the SQM TeMIP Model FM kit from the system, delete the package that was installed.

1. Log in as root user
2. Enter the following commands (subset deletion):

```
# swremove ISTRSQM100.ISTRSQMMFM100V50H
```

Chapter 6

SQM TeMIP Gateway Lifecycle on the Monitoring Director

This section describes the lifecycle of the SQM TeMIP Gateway components running on the Monitoring Director.

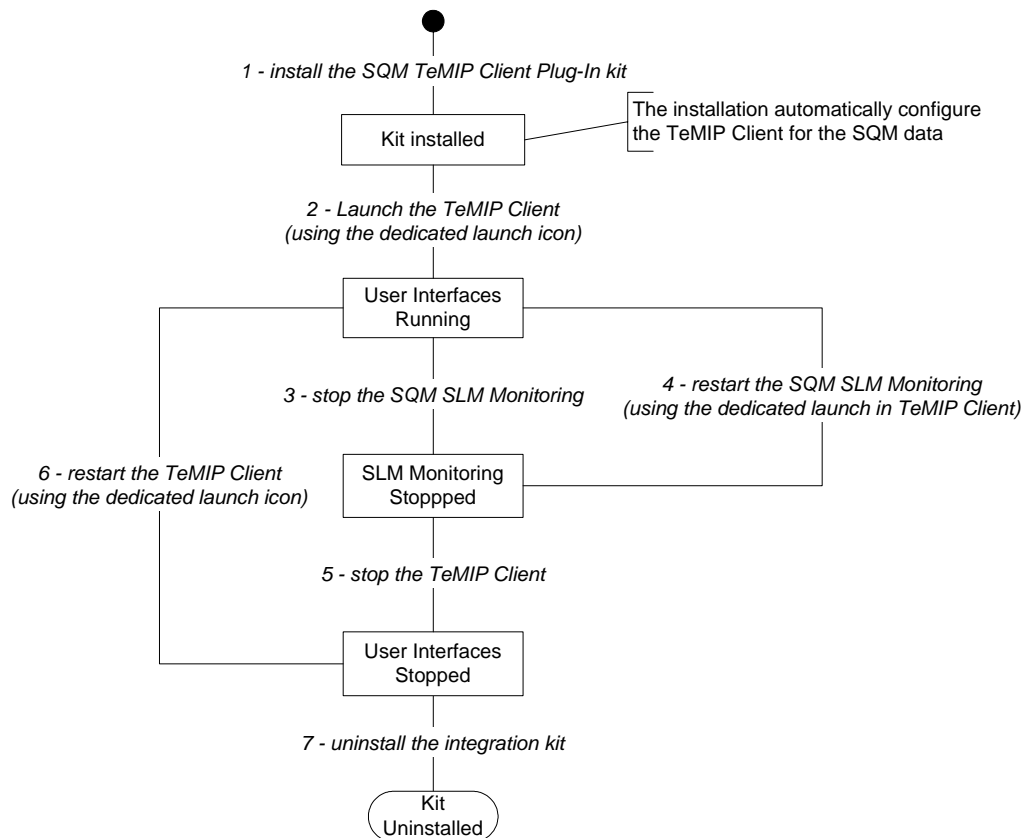

Figure 17 Lifecycle on Monitoring Director

6.1 Software and Hardware Requirements

The Monitoring Director is a client Windows 2000 system.

On the Monitoring Director, the SQM TeMIP Gateway solution requires:

- The SQM SLA monitoring UI installed.
Refer to the *OpenView SQM Installation Guide*.
- The TeMIP Client V5.0 Level 2 Revision G installed and configured.
Refer to the *OpenView TeMIP Installation Guide*.

6.2 SQM TeMIP Client Plug-in

6.2.1 Installation

The SQM TeMIP Client Plug-In must be installed on the system where the TeMIP Client and the SQM SLA Monitoring UI applications are installed.

2 kits are available. They correspond to the 2 supported versions of TeMIP Client. Take care to install the corresponding kit regarding the version of TeMIP Client

Version of TeMIP Client	SQM TeMIP Client Plug-In corresponding kit
TeMIP Client V5.0 Level 2 Consolidation Patch	SQMAHCL-1.20.00
TeMIP Client V5.1 Level 2 Maintenance Release	SQMUIMAHCL510L02-1.20.00

Logging On

Before you start the installation, log onto the administrator account on the system where you want to install the SQM TeMIP Client Plug-In.

Kit Installation

To install the SQM TeMIP Client Plug-In, complete the following steps:

1. Make sure the TeMIP Client V5.0 (or V5.1) for Windows is correctly installed (refer to the OpenView *TeMIP Client V5.0 (or V5.1) for Windows Installation Guide*).
2. Insert the SQM CD-ROM in your CD-ROM drive.
3. Go to the SQM-1.20.00/Windows sub-folder.
4. Install the SQM TeMIP Client Plug-In kit by executing
 - the SQMUIMAHCL-1.20.00.exe program if you are using TeMIP Client V5.0 Level 2
 - the SQMUIMAHCL510L02-1.20.00.exe program if you are using TeMIP Client V5.1 Level 2

The installation **Introduction** window is displayed.

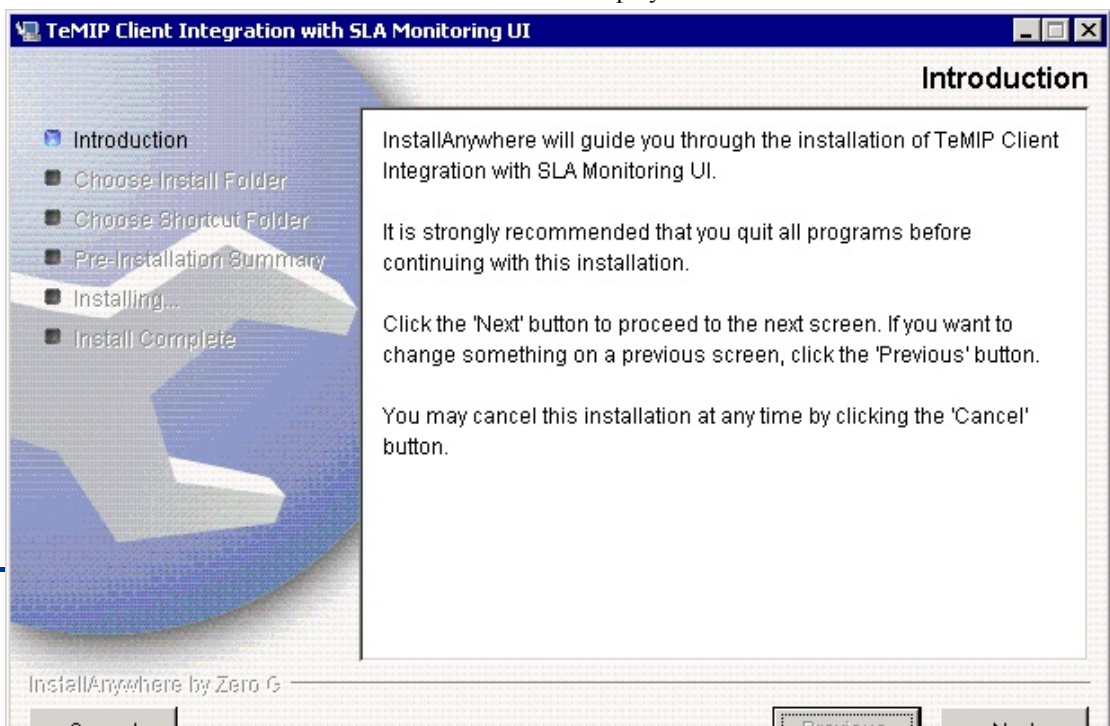

5. Click **Next**.
The installer asks you to choose the product feature to install.
6. Choose **TeMIP Client Integration with SLA Monitoring**.

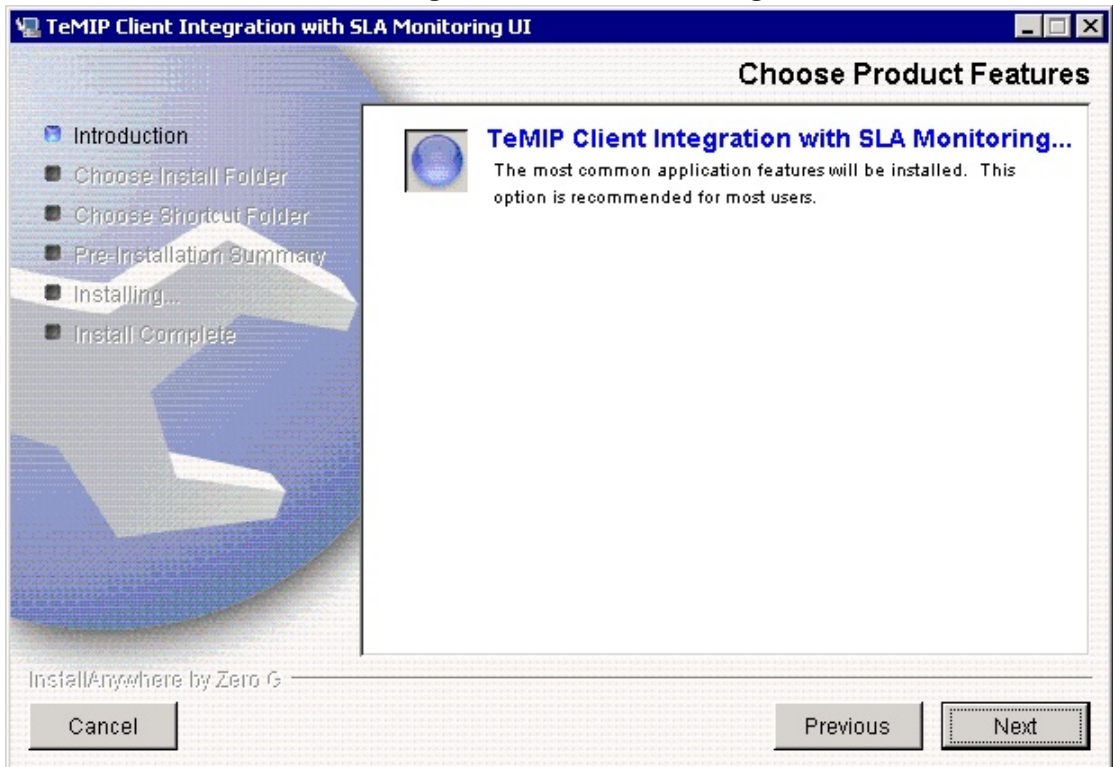

7. Click **Next**.
The installer asks you to choose the TeMIP Client V5.0 for Windows installation folder.
8. Choose the installation folder.

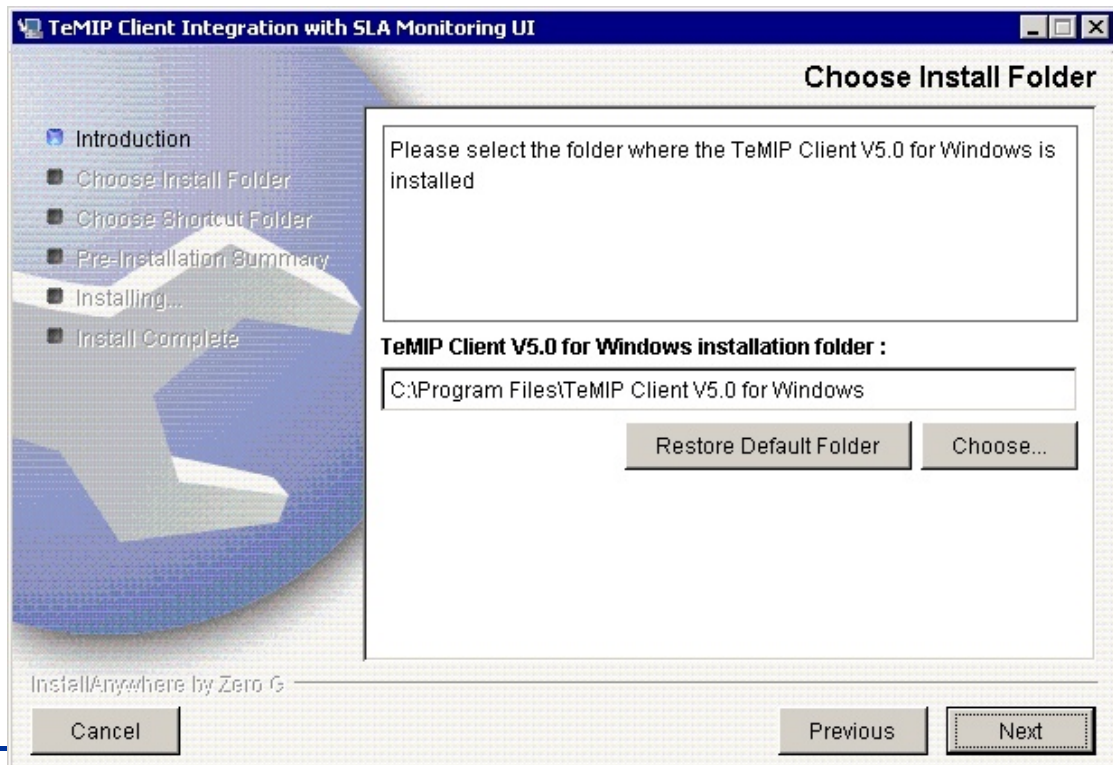

By default, the installer points to the TeMIP Client installation directory. If this is not your choice, click **Choose**, and then use the **Browse for Folder** window to select the TeMIP Client V5.0 (5.1) for Windows installation directory.

Important

It is important to choose the directory `%TEMIP_CLIENT_HOME%` when browsing the installation directory. The `%TEMIP_CLIENT_HOME%` represents the root TeMIP Client installation directory.

9. Click **OK**, then **Next**.

The **Pre-Installation Summary** window is displayed.

10. If there any items you want to change, click **Previous**. Otherwise, click **Install**.

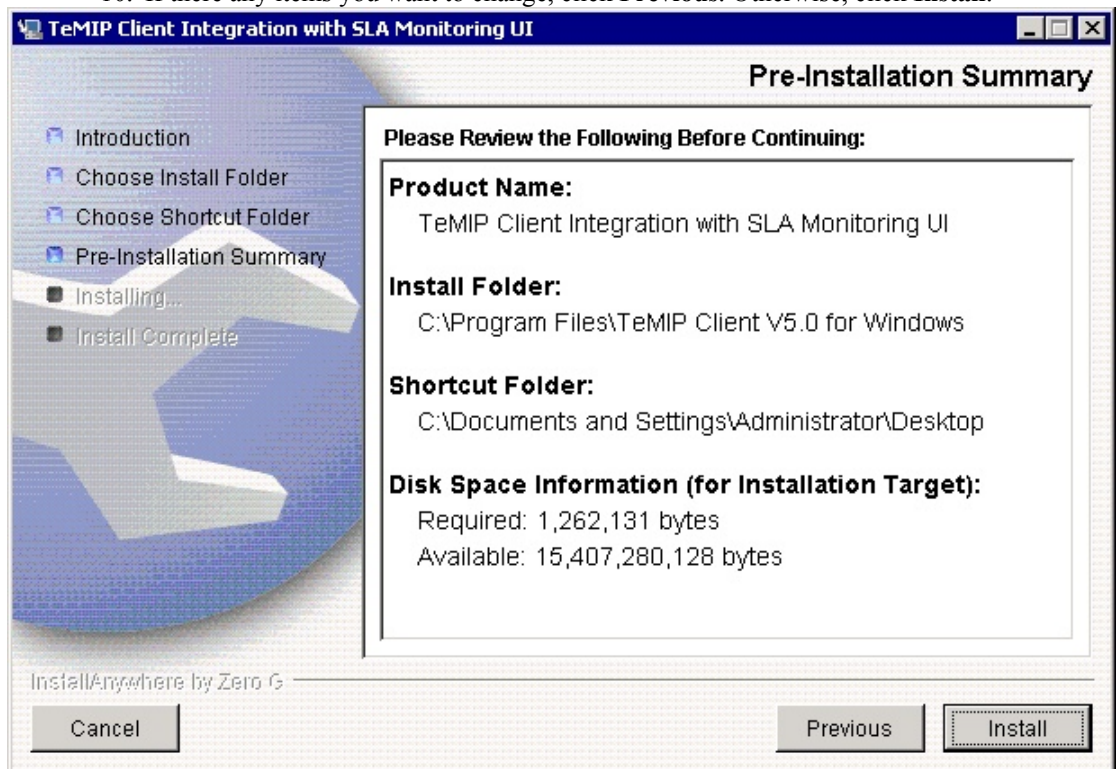

The software is installed and the **Install Complete** window is displayed.

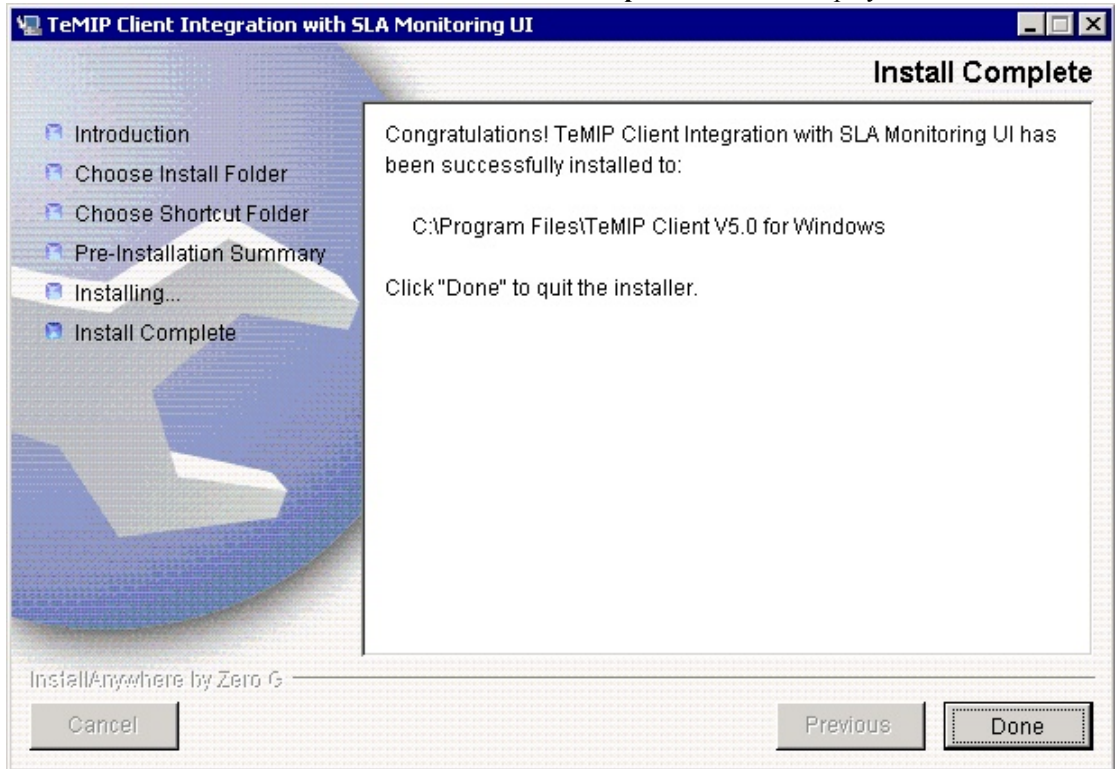

11. To end the installation process, click **Done**.

6.2.2 Setting-up the Plug-in for the TeMIP Client

6.2.2.1 Icon to Launch the TeMIP Client with the SQM SLA Monitoring

Once the TeMIP Client Plug-In for SQM has been installed, an icon called



TeMIP SQM . exe is installed on the desktop.

To run the TeMIP Client with the SQM SLA Monitoring, double-click the icon of the TeMIP SQM . exe application.

This icon is a shortcut to the TeMIP SQM . exe application from the TeMIP Client install directory (by default C:\Program Files\TeMIP Client V5.0 for Windows or C:\Program Files\TeMIP Client V5.1 for Windows).

6.2.2.2 Additional Text Parsing Configuration File

In order to see additional useful columns for the SQM alarms in the TeMIP Client, the *RealTimeAHSsystem.conf* and *HistoryAHSsystem.conf* files must contain the additional text parsing part.

This additional text parsing part is automatically added to these two files at install time.

If for any reason this parsing definition is not present, refer to Appendix B and append the provided lines at the end of these two files.

6.2.3 Uninstallation

Logging On

With the administrator account, log on the system where the TeMIP Client Plug-In for SQM kit is installed.

Kit Uninstallation

1. Locate to the TeMIP Client installation directory.
`cd %TEMIP_CLIENT_HOME%`
2. Go to the `UninstallerDataForTeMIPClientIntegration` sub-directory.
3. Execute the `Uninstall TeMIPClientIntegration.exe` program.

The Introduction screen is displayed.

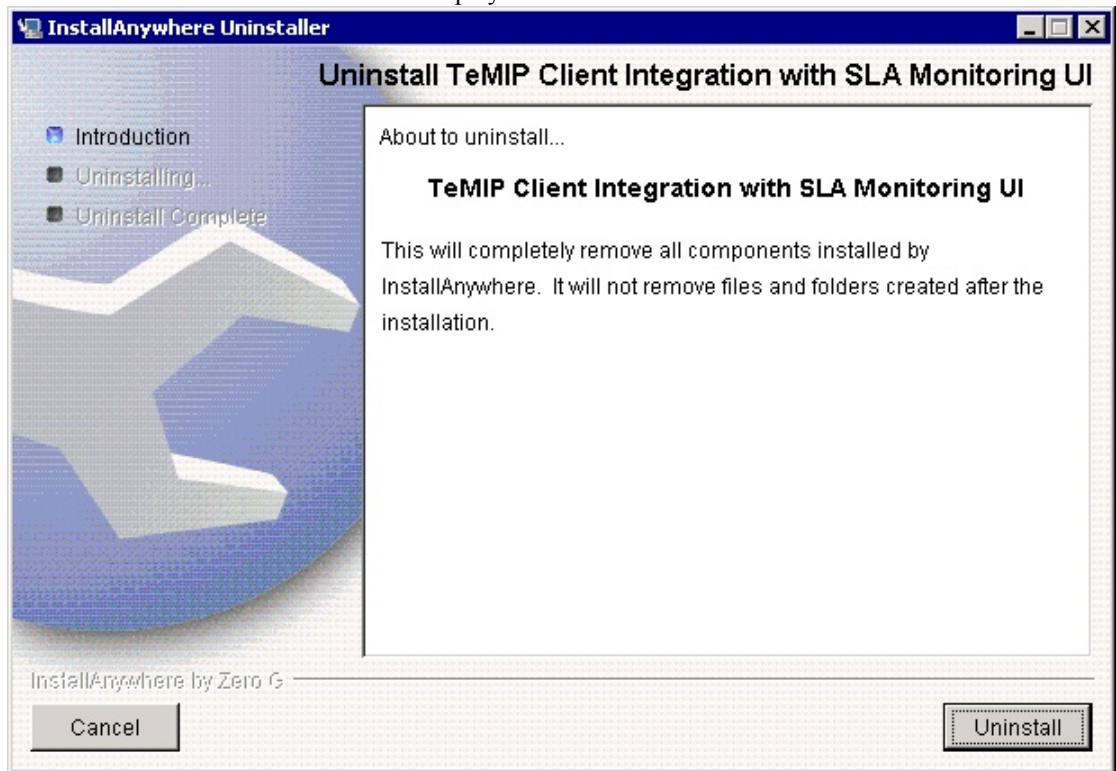

4. Click **Uninstall**. The software is uninstalled from your system.

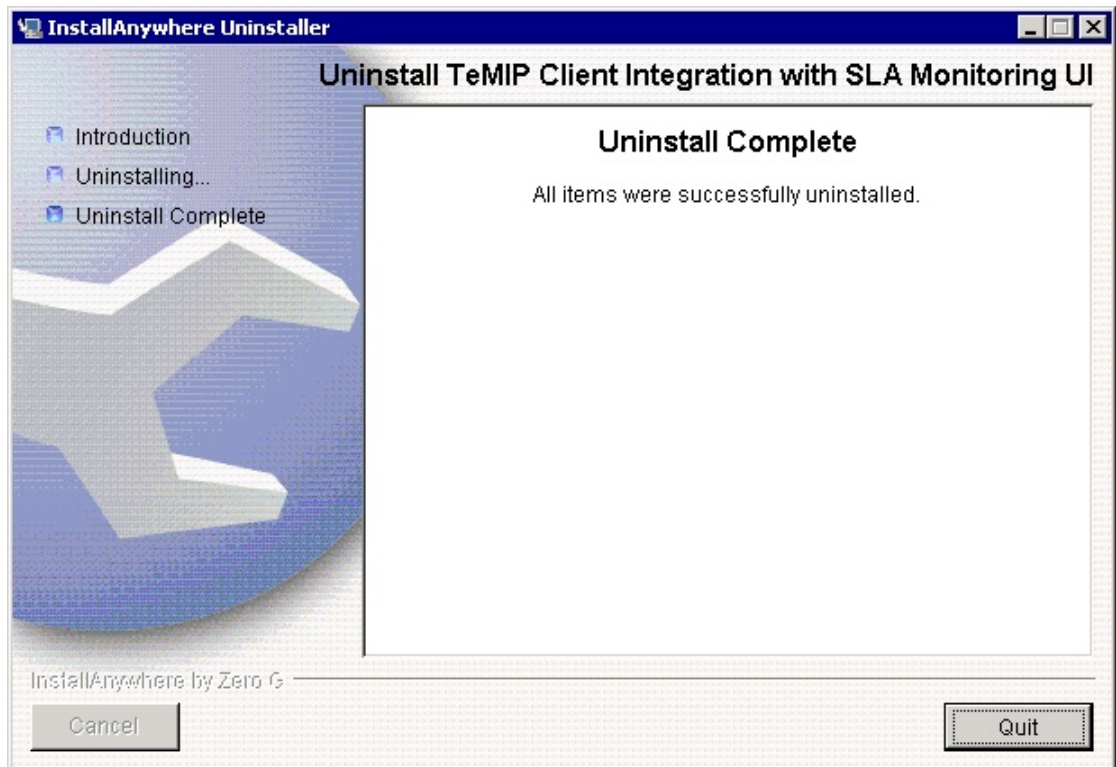

5. To finish, click **Quit**.

Appendix A

Troubleshooting

In this section, we provide useful information for troubleshooting potential problems with the SQM TeMIP Gateway solution.

An Error Occurred when Initializing the Clone's Event Sink SNMP Session

The reason of this error is that the trap dispatcher has never been initialized on the host.

To solve the problem, add the port for the default trap dispatcher in the `/etc/services` file.

Add the following line in the `/etc/services` file:

```
# ist-sink 4242/udp
```

SNMP Trap OID is not defined in the dictionary

The reason of this error is that the `SQM_GTW_AM` is not registered with the trap dispatcher (no UDP port is associated). This can be done through the `ist_setup` command.

```
# ist_setup -m sqm_gtw_am
```

Select option 5 (Trap Dispatcher Management) and then option 8 (Register the Management Module). Enter the port number you want to use.

Another reason of this error can be a `syno` database problem. Check that the `syno` database is running.

Please refer to the *HP OpenView TeMIP Internet SNMP Toolkit (IST) Configuration and Troubleshooting Guide* for more details.

On V5, Traps are not Forwarded

The reason of this error is that the `SQM_GTW_AM` is not registered with the trap dispatcher (no UDP port is associated). This can be done through the `ist_setup` command.

```
# ist_setup -m sqm_gtw_am
```

Select option 5 (Trap Dispatcher Management) and then option 8 (Register the Management Module). Enter the port number you want to use.

Additional Text Parsing Problem

If the additional text parsing is not done correctly in the TeMIP Client Alarm Handling, ensure that you do not have the '!!' characters in the labels of the SQM objects. The '!!' is a reserved keyword in the additional text parsing. It corresponds to the additional text field delimiter.

No alarm displayed in the TeMIP Client Alarm Handling

The first thing to do is to validate that the SQM Host can communicate with the TeMIP Host.

On the SQM host, get the value of the SNMP Manager configuration field set in the SQM SNMP Action Executor component and enter the following command:

```
On SQM Host
# ping <SNMP Manager>
```

Then, on the SQM host, get the value of the Agent Address of the SNMP CONFIGURATION defined and enter the following command:

```
On TeMIP Host
# ping <Agent Address>
```

Additional Text Parsing Configuration

Introduction

The SQM TeMIP Client Plug-in kit provides a customization of the TeMIP Client alarm object fields in order to see additional useful columns for the SQM alarms in the TeMIP Client.

This customization is done by the following configuration file delivered by the TeMIP Client Plug-in and used only when starting the TeMIP client through the TeMIPSQM icon located on the Windows desktop:

```
%TEMIP_CLIENT_HOME%\TeMIPSQM_Config\RealTimeAHSsystem.conf
```

Note

The customization file used when starting the standard TeMIP Client application (clicking on icon named TeMIP Client V5.x for Windows) is located in:
%TEMIP_CLIENT_HOME%\RealTimeAHSsystem.conf

This customization allows parsing the additional text OSI field of the incoming Alarm Objects.

The additional text OSI field is customized with the following parsing information:

- Parsing rules:
[Additional Field General]
start_tag = @@
end_tag = ##
mode = 0
field_sep = !!
nb_additional_field = 40
[End Additional Field General]
- Field definition rule (one for each field)
[Additional Field1]
keyword = RootProblem
header_label = Root Problem
datatype = ALPHANUMERIC
def_value = Unknown
[End Additional Field1]

The TeMIP SQM Gateway Management Module is also customized to emit TeMIP Alarms having the additional text OSI field formatted for this customization. The customization is done in an IST customization file.

As the TeMIP Client supports only one unique definition of additional text parsing. As a consequence if another customization is already used, it is necessary to merge the customization provided by the SQM TeMIP Client Plug-in kit with the existing one. To merge both customizations it is necessary to:

1. Customize the TeMIP SQM Gateway Management Module to use the same type of additional text formatting than other Management Modules.
2. Merge the existing TeMIP Client alarm object fields customization with the customization provided by the SQM TeMIP Client Plug-in kit

Customizing the TeMIP SQM Gateway Management Module Additional Text format

For customizing the Alarms sent by the TeMIP SQM Gateway Management Module it is necessary to update the IST customization associated to the AM.

The customization consists in:

1. Install the MIB subset provided in the The SQM TeMIP Gateway kit . This subset contains the IST customization used by the the TeMIP SQM Gateway Management Module and all the MIB files necessary to compile.
2. Update the IST Customization to modify the format of the additional text OSI fields
3. Reload the updated customization in the AM

Prerequisite

The TeMIP Internet SNMP Toolkit Utilities subset (IST.ISTTKV50H) must be installed on the TeMIP director for being able to update the IST customization. Indeed it implies compiling an IST customization file

MIB subset Installation

4. Insert the SQM SAs and Gateways CD-ROM in your CD-ROM drive.
5. Set up your display.
6. Mount the CD-ROM drive on the /cdrom local directory:

```
# mkdir /cdrom [Return]
# /usr/sbin/pfs_mount /cdrom [Return]
```
7. Copy the **ISTRTSQM100.tape.gz** kit in your working directory. This file is located under the following directory:

```
/cdrom/SQM-1.20.00-SAGTW/HP-UX/<subsetname>
```
8. Unzip the tar file in the working directory where the kit file has been copied from the SA and Gateways CDROM:

```
# gunzip ISTRTSQM100.tape.gz [Return]
```
9. Determine the TeMIP active release (TeMIP-Release):

```
# temip_inventory
```

```
Active TeMIP Release: /usr/opt/TeMIPV50
...
```

10. Install the SQM TeMIP Gateway SNMP AM MIB subset.

To install it, enter the following commands from the directory in which the file has been decompressed:

```
# swinstall -s /<absolute-path-to-kit>/ISTRTSQM100.tape
ISTRTSQM100.ISTSQMMIB100V50H:/usr/opt/<TeMIP-Release> [Return]
```

where:

<TeMIP-Release> represents the root of the TeMIP release tree
<absolute-path-to-kit> represents the full path of the directory where the kit has been copied.

Updating IST Customization

The IST customization must be updated to follow the same additional text formatting rules as the other Management Modules deployed in the TeMIP solution.

It is necessary to replace the delimiter tags by those used by the other MMs.

Example of OSI Additional Text field customization:

```
ADDITIONAL TEXT = "This trap is sent each time a threshold is cross down
indicating the end of operation SLA(s) degradation.\n@@SLAMonitoringType
$slaMonitoringType!!ServiceName $siName!!ServiceLabel
$siLabel!!ServiceDefinitionName $siDefName!!ServiceDefinitionLabel
$siDefLabel!!ServiceComponentName $sciName!!ServiceComponentLabel
$sciLabel!!ServiceComponentType $sciType!!ComponentDefinitionName
$sciDefName!!ComponentDefinitionLabel $sciDefLabel!!TimeStamp
$timeStamp!!ParameterMeasure $measuredParamValue!!RootProblem
$rootCause!!NumberOfImpactedSLA $impactedSLANumber!!AdditionalText
$addText!!ServiceLevelName $slaServiceLevelName!!ServiceLevelLabel
$slaServiceLevelLabel!!SLAName $slaName!!SLALabel $slaLabel!!EntityName
$entityName!!EntityLabel $entityLabel!!EntityType
$entityType!!ComponentServiceLevelName
$sloComponentServiceLevelName!!ComponentServiceLevelLabel
$sloComponentServiceLevelLabel!!ServiceLevelObjectiveName
$sloName!!ServiceLevelObjectiveLabel $sloLabel!!ParameterName
$sloMntrdParamName!!ParameterLabel $sloMntrdParamLabel!!ParameterType
$sloMntrdParamType!!CrossingType $sloCrossingType!!ThresholdName
$sloThreshName!!ThresholdLabel $sloThreshLabel!!ThresholdReferenceValue
$sloThreshReferenceValue!!ActionName $sloThreshActionName!!ActionArg
$thresholdActionArg!!";
```

Update only all the Additional Text defined in the IST customization. Do not modify other fields.

The customization file do modify is located in:

```
/usr/opt/TeMIPV50H/temip/IST/SQMMIB100/SQM_SYSTEM.cst
```

Loading the updated IST customization in the SQM Gateway AM

To update the IST customization

1. Log as root user
2. Go to the customization file directory

```
# cd /usr/opt/TeMIPV50H/temip/IST/SQMMIB100
```

3. Run the IST customization tool

```

# ist_custom_tool -c SQM_SYSTEM.cst -m SQM_GTW_AM
>> Set the customization filename...

<< Set the customization filename : SQM_SYSTEM.cst
Done

      TeMIP IST Customization tool
      -----

Please select one of the following actions:

0) Exit the TeMIP IST Customization tool
1) Set the customization filename : [SQM_SYSTEM.cst]
2) Set the SNMP module name : [sqm_gtw_am]
3) Customization Management
4) Customization MSL Management
5) Customization SNMP Dictionary Management
6) Customization Configuration file Management
7) AM trap dispatcher filter file management
8) AM Management
9) Deployment kit management

Action to execute (or help):

```

4. Select action 5 (**Customization SNMP Dictionary Management**):

```

      Customization SNMP Dictionary Management Menu
      -----

Please select one of the following actions:

0) Return to main menu
1) Generate the SNMP dictionary file for the customization
2) Add the SNMP dictionary file to the AM SNMP dictionary
3) Remove the SNMP dictionary file from the AM SNMP
dictionary
4) Update the SNMP dictionary file

Action to execute :

```

5. Select action 1 (Generate the SNMP dictionary file for the customization) to generate the new SNMP Dictionary
6. Select action 4 to load the new SNMP Dictionary in the SQM Gateway AM. The SNMP Dictionary is reloaded on the fly without stopping the AM.

Merging an TeMIP Client alarm object fields customization

This section describes how merging existing alarm object fields customization with those defined by SQM TeMIP Client Plug-in kit. Merging both customization will allow using a single TeMIP Client desktop instead of 2 desktop, 1 for the standard TeMIP Client, the other for the SQM TeMIP Client.

The merge consists in:

1. Define the Launch Application provided by the SQM TeMIP Client Plug-in kit into the standard TeMIP Client desktop. To do it, copy the file
 %TEMIP_CLIENT_HOME%\TeMIPSQM_SystemLaunch\TeMIPSQM_Launch.conf into the directory
 %TEMIP_CLIENT_HOME%\TeMIPClient_SystemLaunch

2. Merge the SQM columns customization in the default customization, by merging the file
%TEMIP_CLIENT_HOME%\TeMIPSQM_Config\RealTimeAHSsystem.conf
into %TEMIP_CLIENT_HOME%\RealTimeAHSsystem.conf:

The SQM columns customization defines 40 columns. So if the existing customization defines 10 columns update the option 'nb_additional_field'

```
[Additional Field General]
start_tag = @@
end_tag = ##
mode = 0
field_sep = !!
nb_additional_field = 50
[End Additional Field General]
```

- a. Add in the file
%TEMIP_CLIENT_HOME%\RealTimeAHSsystem.conf the 40 columns defined in the SQM customization
(%TEMIP_CLIENT_HOME%\TeMIPSQM_Config\RealTimeAHSsystem.conf)

```
[Additional Field1]
keyword = RootProblem
header_label = Root Problem
datatype = ALPHANUMERIC
def_value = Unknown
[End Additional Field1]
```

Important

Once the merge is done, the TeMIP Client must be started using the standard TeMIP client icon located on the Windows desktop (icon named TeMIP Client V5.x for Windows)

For more information about TeMIP Client alarm object fields customization see the hp OpenView TeMIP Client Installation and Configuration Guide chapter 2.2.1.3

Appendix C

TeMIP IST Configuration

Before configuring the SQM TeMIP Gateway SNMP AM and Model FM, it is necessary that the TeMIP IST is setup and configured.

To configure the IST, perform the following operations:

Configure the IST applications (SNMP AM and TeMIP Trap Dispatcher):

/usr/opt/temip/bin/ist_setup

Option 2: to run a full configuration: installation of the Internet System, MIBII and TNS customizations + creation of the SNMP_CONFIGURATION instance + configuration of the TeMIP Trap Dispatcher

Option 5 → **2:** Enable the TeMIP trap dispatcher.

Appendix D

Manual registration of the TeMIP Global Instances

Discovery

To manually discover the SQM Customers and Operations, perform the following operations:

1. Log on as 'sqmadm' user on the SQM SLM Primary Server.
2. Set the SQM Environment.
To do this, source the '\$TEMIP_SC_VAR_HOME/temip_sc_env.sh' file.
Example:

```
> . /var/opt/OV/SQM/slmv12/temip_sc_var_home.sh
```

3. Ensure that the SQM Kernel is running.
To do this, perform the 'temip_sc_show_kernel' command.
Example:

```
>temip_sc_show_kernel

MINE  PID  UID  Component  Status  Start Time  CPU Time
Yes   9587 sqmadm  rvd        R Sep 27   88:16 tcp:6600 -http:9699
Yes   9580 sqmadm  tibhawkhma R Sep 27   11:00
Yes   9576 sqmadm  scha       R Sep 27   85:42
Yes   9578 sqmadm  schaw      R Sep 27   47:17
Yes   9589 sqmadm  Repository R Sep 27   28:51
Yes   9622 sqmadm  schawkevent R Sep 27   25:48
```

4. Ensure that the SQM Service Repository Manager (SRM) is running.
To do this, perform the 'temip_sc_show_application' command.
Example:

```
> temip_sc_show_application -platform slmv12 -director slmonitoring
-application SRM

Processing /tibco/private/adaptor/ServiceCenter/PlatformDescription/
slmv12/platform ...
Application SRM :
  applicationType = Monitored
  host           = <hostname>
Application SRM is RUNNING
```

Else, start it using the 'temip_sc_start_application' command.

Example:

```
> temip_sc_start_application -platform slmv12 -director slmonitoring
-application SRM
```

5. Perform the 'temip_sc_get_cust' command.

This command returns an XML file describing the current SQM Customers and Operations Example:

```
> temip_sc_get_customer
...
<?xml version="1.0" encoding="UTF-8"?>
<!DOCTYPE sc:GetFilteredCustListReply SYSTEM
"DTD/tsc CustomerDefSrv.dtd">
<sc:GetFilteredCustListReply
xmlns:sc="http://www.compaq.com/TeMIP/ServiceCenter" msg.id="43">
  <sc:CustomerDefs
xmlns:sc="http://www.compaq.com/TeMIP/ServiceCenter">
    <sc:CustomerDef
xmlns:sc="http://www.compaq.com/TeMIP/ServiceCenter"
customer.name="Compaq" customer.label="_LABEL Compaq"
creationTimeStamp="2004-10-20T15:15:01.528"
modificationTimeStamp="2004-10-20T15:15:01.528" type="Customer">
    ...
    </sc:CustomerDef>
    <sc:CustomerDef
xmlns:sc="http://www.compaq.com/TeMIP/ServiceCenter"
customer.name="HP" customer.label="_LABEL HP"
creationTimeStamp="2004-10-20T15:15:02.102"
modificationTimeStamp="2004-10-20T15:15:02.102" type="Customer">
    ...
    </sc:CustomerDef>
    <sc:CustomerDef
xmlns:sc="http://www.compaq.com/TeMIP/ServiceCenter"
customer.name="MyOperation" customer.label="Default Operation"
creationTimeStamp="2004-09-23T06:34:20.698"
modificationTimeStamp="2004-09-23T06:34:20.698" type="Operation">
    ...
    </sc:CustomerDef>
    <sc:CustomerDef
xmlns:sc="http://www.compaq.com/TeMIP/ServiceCenter"
customer.name="VideoMaintenance" customer.label="_LABEL
VideoMaintenance" creationTimeStamp="2004-10-20T15:15:02.610"
modificationTimeStamp="2004-10-20T15:15:02.610" type="Operation">
    ...
    </sc:CustomerDef>
  </sc:CustomerDefs>
</sc:GetFilteredCustListReply>
```

Registration

Any SQM customer or operation must be registered as follows (on the TeMIP Director, with the 'temip' user):

- Every TeMIP instance corresponding to a SQM customer must be registered as an instance of the SERVICE_CUSTOMER global class.
- Every TeMIP instance corresponding to a SQM operation must be registered as an instance of the SERVICE_OPERATION global class.

Example of invocation:

```
Manage > register SERVICE_CUSTOMER HP
Manage > register SERVICE_OPERATION VideoMaintenance
```

Moreover, it is mandatory to register the 'default SLA' (on which the root alarms are targeted) as an instance of the SERVICE_ROOT class.

Corresponding invocation:

```
Manage > register SERVICE_ROOT DefaultSLA
```

Declaration as member of the SQM domain

All the SQM TeMIP Gateway Global instances created in TeMIP must be members of a domain (on the TeMIP Director, with the 'temip' user).

Example of invocation (when the domain is named 'SQMDomain':

```
Manage > create domain SQMDomain member MyOperation
```