



Operations Manager i

Software Version: 10.61

OMi Integrations Guide

Document Release Date: April 2017

Software Release Date: April 2017



Hewlett Packard
Enterprise

Legal Notices

Warranty

The only warranties for Hewlett Packard Enterprise products and services are set forth in the express warranty statements accompanying such products and services. Nothing herein should be construed as constituting an additional warranty. Hewlett Packard Enterprise shall not be liable for technical or editorial errors or omissions contained herein.

The information contained herein is subject to change without notice.

Restricted Rights Legend

Confidential computer software. Valid license from Hewlett Packard Enterprise required for possession, use or copying. Consistent with FAR 12.211 and 12.212, Commercial Computer Software, Computer Software Documentation, and Technical Data for Commercial Items are licensed to the U.S. Government under vendor's standard commercial license.

Copyright Notice

© 2015 - 2017 Hewlett Packard Enterprise Development LP

Trademark Notices

Adobe® and Acrobat® are trademarks of Adobe Systems Incorporated.

AMD, the AMD Arrow symbol and ATI are trademarks of Advanced Micro Devices, Inc.

Citrix® and XenDesktop® are registered trademarks of Citrix Systems, Inc. and/or one more of its subsidiaries, and may be registered in the United States Patent and Trademark Office and in other countries.

Google™ and Google Maps™ are trademarks of Google Inc.

Intel®, Itanium®, Pentium®, and Intel® Xeon® are trademarks of Intel Corporation in the U.S. and other countries.

iPad® and iPhone® are trademarks of Apple Inc.

Java is a registered trademark of Oracle and/or its affiliates.

Linux® is the registered trademark of Linus Torvalds in the U.S. and other countries.

Microsoft®, Windows®, Lync®, Windows NT®, Windows® XP, Windows Vista® and Windows Server® are either registered trademarks or trademarks of Microsoft Corporation in the United States and/or other countries.

NVIDIA® is a trademark and/or registered trademark of NVIDIA Corporation in the U.S. and other countries.

Oracle is a registered trademark of Oracle Corporation and/or its affiliates.

Red Hat® is a registered trademark of Red Hat, Inc. in the United States and other countries.

SAP® is the trademark or registered trademark of SAP SE in Germany and in several other countries.

UNIX® is a registered trademark of The Open Group.

Documentation Updates

To check for recent updates or to verify that you are using the most recent edition of a document, go to: <https://softwaresupport.hpe.com/>.

This site requires that you register for an HPE Passport and to sign in. To register for an HPE Passport ID, click **Register** on the HPE Software Support site or click **Create an Account** on the HPE Passport login page.

You will also receive updated or new editions if you subscribe to the appropriate product support service. Contact your HPE sales representative for details.

Support

Visit the HPE Software Support site at: <https://softwaresupport.hpe.com/>.

Most of the support areas require that you register as an HPE Passport user and to sign in. Many also require a support contract. To register for an HPE Passport ID, click **Register** on the HPE Support site or click **Create an Account** on the HPE Passport login page.

To find more information about access levels, go to: <https://softwaresupport.hpe.com/web/softwaresupport/access-levels>.

HPE Software Solutions Now accesses the Solution and Integration Portal website. This site enables you to explore HPE product solutions to meet your business needs, includes a full list of integrations between HPE products, as well as a listing of ITIL processes. The URL for this website is <https://softwaresupport.hpe.com/km/KM01702731>.

Contents

Part I: Introduction	9
Chapter 1: Integrating with Other Applications - Overview	10
Part II: Operations Manager i - Application Performance Management Integration	11
Chapter 2: OMi - APM Integration Overview	12
Chapter 3: How to Integrate BSM with OMi	14
Before You Begin: To integrate a BSM deployment that has been upgraded from BSM 9.24 (or earlier)	14
(RTSM only) Step 1: Install the UCMDB Data Flow Probe	19
(external UCMDB only) Step 1: Prepare the topology synchronization ...	21
Task 1: Create Integration Point in UCMDB for BSM	21
Task 2: Create Integration Job to pull CIs from BSM	22
Task 3: Create Integration Point in UCMDB for OMi	22
Task 4: Create Integration Job to Push CIs to OMi	23
Task 5: Verify the Topology Synchronization	24
Step 2: Set Up TLS and Root Certificates	24
Step 3: Configure Lightweight Single Sign-On	25
Step 4: Create the Integration User	26
How to Change the Integration User's Password	27
(APM 9.30 only) Creating a Standard User with Integration User Role	28
Step 5: Set Up an APM Connected Server in OMi and Complete the Integration	29
Verify the Integration	32
Continue the Setup of BSM in OMi and Start the Integration	33
(APM 9.30 only) Step 6: Enabling Alert and Status Forwarding	34
(APM 9.30 only) Step 7: Creating OMi Authentication User Name and Password	34
(APM 9.30 only) Step 8: Importing Certificates for REST Service	35
(APM 9.30 only) Step 9: Using Unsecured http REST Access	36
Step 10: KPI Assignments in OMi	37
Additional APM-OMi Integration Configurations	38

Troubleshooting for the APM-OMi Integration	39
Chapter 4: How to Display BSM Data in OMi	42
Chapter 5: How to Customize BSM-OMi Integration	44
Chapter 6: How to Create and Forward End User Management Alerts to OMi	45
Part III: Operations Manager i - HPE SiteScope Integration	46
Chapter 7: SiteScope Integration - Overview	47
Chapter 8: SiteScope Integration - Tasks	48
Part IV: Operations Manager i - HPE Operations Manager Integration	57
Chapter 9: Operations Manager i - HP Operations Manager Integration Overview	58
Chapter 10: Workflow: Configuring Connections Between Operations Manager i and OM	60
Chapter 11: Establishing a trust relationship for a server connection	62
Chapter 12: Verifying the trusted relationship	65
Chapter 13: How to Create a Connection to an OM Server	66
Chapter 14: How to Run Topology Synchronization	70
Chapter 15: How to Configure the OM for Windows Forwarding Policy	76
Chapter 16: How to Configure the OM for UNIX or Linux Forwarding Policy	79
Chapter 17: How to Validate Event Synchronization	83
Chapter 18: How to Set up Operations Manager i in an Environment Managed by OM	85
Optional. How to Set Up Forwarding Targets for OM Agent Node Creation	85
Chapter 19: OMi Field Mapping	87
Chapter 20: Troubleshooting	90
Part V: Operations Manager i - Service Manager Integration	92
Chapter 21: Operations Manager i - Service Manager Integration Overview	93
Versions	93
Integration Options	93
Chapter 22: OMi-SM Integration with RTSM	97
Data Flow Probe	97
Create User Accounts for the OMi-SM Integration (RTSM)	98
RTSM-Service Manager Integration	99
Enable LW-SSO for the OMi-SM Integration (RTSM)	100
View Actual State in SM (RTSM)	108

Event Forwarding from OMi to SM (RTSM)	109
Step 1: Configure the Service Manager server as a connected server in OMi	109
Step 2: (optional) Configure an Event Forwarding Rule	113
Step 3: Configure the OMi integration in Service Manager	114
Step 4: Configure Launch of Service Manager Incident Details from OMi	119
(optional) Step 5: Attribute Synchronization	120
Step 6: Test the Event Forwarding and Cross Launches	125
Advanced Configuration	127
Downtime Forwarding from Service Manager to OMi (RTSM)	131
Step 1: Add an SMBSM_DOWNTIME integration instance in SM	131
Step 2: Tailor Service Manager to handle phase change	134
Step 3: Set up downtime sync jobs in OMi	135
Step 4: Set up creation of BSM Downtime CIs	136
Step 5: Verify the SM-OMi downtime synchronization setup	137
Sending downtime notifications from OMi to SM (RTSM)	140
Step 1: Send OMi Downtime Events to SM	140
View Changes and Incidents in OMi (RTSM)	141
Prerequisite	142
Step 1: Configure the Service Manager Adapter Time Zone	142
Step 2: Create an Integration Point in OMi	143
Step 3: Edit Integration TQLs	144
Step 4: Verify View changes and incidents	145
How to Customize the Changes and Incidents Component	145
Naming Constraints for New Request for Change TQLs	146
Naming Constraints for New Incident TQLs	147
Business Impact Report (BIR) (RTSM)	148
Step 1: Add a Business Impact Report Integration in SM	148
Step 2: Launch a Business Impact Report from an Incident	150
Customizing the Service Manager Integration	150
Mapping Table: OMi Event to BDM Incident Property	159
Chapter 23: OMi-SM Integration with UCMDB	166
Data Flow Probes	167
Create User Accounts for the OMi-SM Integration (UCMDB)	168

UCMDB-Service Manager Integration	169
OMi-UCMDB Integration	169
Enable LW-SSO for the OMi-SM Integration (UCMDB)	170
View Actual State in SM (UCMDB)	178
Event Forwarding from OMi to SM (UCMDB)	179
Step 1: Configure the Service Manager server as a connected server in OMi	180
Step 2: (optional) Configure an Event Forwarding Rule	183
Step 3: Configure the OMi integration in Service Manager	184
Step 4: Configure Launch of Service Manager Incident Details from OMi	189
(optional) Step 5: Attribute Synchronization	190
Step 6: Test the Event Forwarding and Cross Launches	196
Advanced Configuration	197
Downtime Forwarding from Service Manager to OMi (UCMDB)	201
Step 1: Add an SMBSM_DOWNTIME integration instance in SM	202
Step 2: Tailor Service Manager to handle phase change	204
Step 3: Set up downtime sync jobs in UCMDB	205
Step 4: Set up creation of BSM Downtime CIs	206
Step 5: Verify the SM-OMi downtime synchronization setup	207
Sending downtime notifications from OMi to SM (UCMDB)	210
Step 1: Send OMi Downtime Events to SM	210
View Changes and Incidents in OMi (UCMDB)	212
Prerequisite	212
Step 1: Configure the Service Manager Adapter Time Zone	213
Step 2: Create an Integration Point in OMi	213
Step 3: Edit Integration TQLs	214
Step 4: Verify View changes and incidents	215
How to Customize the Changes and Incidents Component	216
Naming Constraints for New Request for Change TQLs	217
Naming Constraints for New Incident TQLs	218
Business Impact Report (BIR) (UCMDB)	218
Step 1: Add a Business Impact Report Integration in SM	219
Step 2: Launch a Business Impact Report from an Incident	220
Customizing the Service Manager Integration	221

Mapping Table: OMi Event to BDM Incident Property	230
Part VI: Operations Manager i - Network Node Manager i Integration	236
Chapter 24: Operations Manager i - Network Node Manager i Integration Overview	237
Chapter 25: How to Integrate Network Node Manager i with Operations Manager i	238
Chapter 26: NNMi Components in My Workspace	240
Part VII: Operations Manager i - Operations Orchestration Integration	242
Chapter 27: Operations Manager i - Operations Orchestration Integration Overview	243
Chapter 28: How to Integrate Operations Manager i and Operations Orchestration	244
Chapter 29: Troubleshooting Integration Problems	252
Chapter 30: Examples of Operations Manager i and Operations Orchestration Integrations	254
Part VIII: Operations Manager i - Operations Bridge Analytics Integration	255
Chapter 31: Operations Manager i - Operations Bridge Analytics Integration Overview	256
Chapter 32: Operations Bridge Analytics Cross Launch	257
How to set up a Cross Launch Integration for OMi Events	257
How to Use a Cross Launch Integration from OMi	258
Chapter 33: Workflow: Configuring Connections Between OMi and OBA ..	259
Overview: Forwarding OBA Alerts and Anomalies to OMi	260
OpsA 2.3x Only: Installing the Operations Agent on the OpsA Server ...	260
How to Connect the Operations Agent to OMi	261
Importing Content Packs from the OBA Server	262
How to Deploy and Assign Management Templates to an OBA Server	263
Chapter 34: OBA Dashboard Integration	265
Part IX: OpsCx Integrations	267
Send documentation feedback	269

Part I: Introduction

Chapter 1: Integrating with Other Applications - Overview

Integrating OMi with other software products is a great way to extend your IT management capability. This document describes some of the major integrations between OMi and other HPE products, but does not constitute a full list of all possible integrations. For a complete list of available product integrations, see the [Integrations Catalog](#) on HPE Software Support.

Note: If you are running OMi as part of the Operations Bridge Suite in a containerized environment, be sure to read the Operations Bridge Suite help before following the instructions in this guide. While much of the information in this guide also applies to a containerized deployment, the Operations Bridge Suite help points out important differences that you must keep in mind when reading the information presented here.

OMi-OMi Integrations

Integrations between multiple OMi deployments enable the exchange of events by using event synchronization and topology synchronization.

For more information on working with multiple OMi deployments, see the *OMi Administration Guide*.

OMi-Configuration Management Systems Integrations

OMi integrates with HPE Universal CMDB to enable sharing topologies (CIs and relationships) between instances and enabling a consistent CI ID in an environment. The integration uses the Configuration Management System (CMS) topology. A single instance is configured to be the CMS and the global ID generator; synchronization is achieved by using the topology synchronization.

For details on setting up these integrations, see the *Data Flow Management Guide*.

SSL Setup

Ensure that the software products that you are integrating use the same SSL setup. For example, it is not supported to use HTTP for OO and at the same time HTTPS for OMi, or vice versa.

Part II: Operations Manager i - Application Performance Management Integration

Chapter 2: OMi - APM Integration Overview

Important: In the following sections, we will refer to the *product* as BSM, and to the *integration* of BSM 9.25 and later, and APM 9.30, with OMi as the APM Integration.

The Application Performance Management (APM) integration of BSM with OMi enables you to:

- Integrate user interface components from separately deployed APM systems directly into the OMi's MyWorkspace pages. In this way, relevant information is shown directly within the OMi user interface, although this data comes from the BSM system.
- Use the OMi embedded graphing component to show performance data stored within the Profile database of the BSM system. For detailed information around business transactions, business transaction flows, or specific information about location-based monitoring within BSM, it will be required to drill down into MyBSM pages. For this purpose, OMi provides drill-down operations that allow to launch the BSM user interface in the context of a specific CI or event.

For information on supported version see the [Integrations Catalog](#).

Understanding the Integration Process

Each instance of the APM Integration is represented in OMi as a connected server. If you are integrating multiple BSMs, each one will be a separate connected server.

When you integrate BSM with OMi, there are a number of steps that occur behind the scenes:

1. **Topology Synchronization.** The first step of the integration involves pulling the topology of CIs from BSM into OMi. This can take some time, and in very large environments can take several hours.

The topology of domain-specific CIs such as Business Transactions (BTs) and Business Transaction Flows (BTFs) are not synchronized by default. Instead, we synchronize the Business Application CI which reflects any status changes to these CIs and any BT/BTF CIs that are related to it in BSM.

Note that the following procedure describes how to integrate BSM into OMi by using the default integration TQLs. If you have any topologies not covered by the out-of-the-box TQLs, create a custom integration TQL. The TQL needs to be defined on the BSM side. For information on how to create an integration TQL, see the *Modeling Guide*.

Topology from BSM can also be synchronized via an external UCMDB. In this case, BSM CIs are pulled into the UCMDB and then pushed to OMi. For more information on setting up the topology synchronization with an external UCMDB, see "[\(external UCMDB only\) Step 1: Prepare the topology synchronization](#)" on page 21.

2. **BSM Status Change Alert Creation.** After the BSM topology is integrated into OMi, BSM status change alerts are created within BSM to generate events upon HI or KPI status change. Forwarding rules then define that these alerts will be sent to OMi. As a result, when a CI's status changes in BSM, an event is sent to OMi to update the CI's status.

3. **Initial Status Synchronization.** When setting up the APM-OMi integration, there is an initial status synchronization so that each CI in OMi receives the status it has in BSM. After the initial synchronization, whenever a CI's status changes in BSM, OMi receives a status change event. This event changes the CI's status in OMi, but the event is *not* displayed in the Event Console.

In general, when a KPI's status changes in BSM, the KPI changes status in OMi. In addition, if an HI's status changes on one of the CIs that we synchronized from BSM into OMi, this status change is reflected directly in OMi.

4. **Downtime Synchronization.** After the above steps are complete, you can synchronize downtimes, so that any downtimes defined in OMi will also apply to BSM. This includes the downtime CI, the CIs connected to the downtime, and the scheduling and action configurations (such as stopping monitoring, sending alerts and emails, and so on). In addition, OMi serves as the central downtime management location, so you can enable one time initial synchronization of BSM downtime to OMi, in order to help start managing all downtimes on the OMi side.

Chapter 3: How to Integrate BSM with OMi

To integrate BSM with an OMi deployment, complete the following steps if your BSM deployment is not upgraded from BSM 9.24 (or earlier):

- "(RTSM only) Step 1: Install the UCMDB Data Flow Probe" on page 19 or "(external UCMDB only) Step 1: Prepare the topology synchronization" on page 21
- "Step 2: Set Up TLS and Root Certificates" on page 24
- "Step 3: Configure Lightweight Single Sign-On" on page 25
- "Step 4: Create the Integration User" on page 26
- "Step 5: Set Up an APM Connected Server in OMi and Complete the Integration" on page 29
- "(APM 9.30 only) Step 6: Enabling Alert and Status Forwarding" on page 34
- "(APM 9.30 only) Step 7: Creating OMi Authentication User Name and Password" on page 34
- "(APM 9.30 only) Step 8: Importing Certificates for REST Service" on page 35
- "(APM 9.30 only) Step 9: Using Unsecured http REST Access" on page 36
- "Step 10: KPI Assignments in OMi " on page 37
- "Troubleshooting for the APM-OMi Integration" on page 39

Before You Begin: To integrate a BSM deployment that has been upgraded from BSM 9.24 (or earlier)

To integrate a BSM 9.25 (or later) deployment that has been upgraded from a running BSM 9.24 (or earlier), you must complete the following steps first.

If you integrate remotely, copy all the content packs to your computer and then point to the local location to deploy the package.

1. (For BSM 9.2x only) On your BSM server, check if uCMDB content pack 11.13.859 is installed. On the BSM system, navigate to:

Admin > RTSM Administration > Administration > Package Manager.

Click **Install Content Pack**. If the Install Content Pack window displays the current version of the installed content pack, continue with the next step. Otherwise, install the content pack by using the Package Manager as follows:

- a. Navigate to **Admin > RTSM Administration > Administration > Package Manager** to open the RTSM Package Manager.
 - b. Click  **Install Content Pack** to open the **Install Content Pack** window.
 - c. Select 11* from **Version** and click **Install** to install the content pack version 11. Note that you will only see content packs that are available but not yet installed. Those that are installed, you will not see here.
2. On your BSM server, import all the packages listed below. Note that you must import these .zip files, even if these files are already present on the BSM server:

BLE.zip



Business.zip

Diagnostics.zip



OMi_Integration.zip

Sitescope.zip

To get the TQLs from BLE.zip:



- a. Navigate to **Admin > RTSM Administration > Administration > Package Manager** to open the RTSM Package Manager.
- b. Click  to open the **Deploy Packages to Server** window and click .
- c. Navigate to `<BSM_HOME>/odb/conf/factory_packages`.
- d. Open BLE.zip, then click BLE.zip to see the list of resources.
- e. Click **Deploy** to deploy your resource and click **ok** in the box **Resources have been deployed successfully**.

To get the TQLs from Business.zip:



- a. Navigate to **Admin > RTSM Administration > Administration > Package Manager** to open the RTSM Package Manager.
- b. Click  to open the **Deploy Packages to Server** window and click .
- c. Navigate to `<BSM_HOME>/odb/conf/factory_packages`.
- d. Open Business.zip, then click Business.zip to see the list of resources.

- e. Click **Deploy** to deploy your resource and click **ok** in the box **Resources have been deployed successfully**.



To get the TQLs from Diagnostics.zip:

- a. Navigate to **Admin > RTSM Administration > Administration > Package Manager** to open the RTSM Package Manager.
- b. Click  to open the **Deploy Packages to Server** window and click .
- c. Navigate to `<BSM_HOME>/odb/conf/factory_packages`.
- d. Open `Diagnostics.zip`, then click `Diagnostics.zip` to see the list of resources.
- e. Click **Deploy** to deploy your resource and click **ok** in the box **Resources have been deployed successfully**.

To get the TQLs from OMi_Integration.zip:

- a. Navigate to **Admin > RTSM Administration > Administration > Package Manager** to open the RTSM Package Manager.
- b. Click  to open the **Deploy Packages to Server** window and click .
- c. Navigate to `<BSM_HOME>/odb/conf/factory_packages`.
- d. Open `OMi_Integration.zip`, then click `OMi_Integration.zip` to see the list of resources.
- e. Click **Deploy** to deploy your resource and click **ok** in the box **Resources have been deployed successfully**.

To get the TQLs from Sitescope.zip:

- a. Navigate to **Admin > RTSM Administration > Administration > Package Manager** to open the RTSM Package Manager.
- b. Click  to open the **Deploy Packages to Server** window and click .
- c. Navigate to `<BSM_HOME>/odb/conf/factory_packages`.
- d. Open `Sitescope.zip`, then click `Sitescope.zip` to see the list of resources.
- e. Click **Deploy** to deploy your resource and click **ok** in the box **Resources have been deployed successfully**.

To validate that these packages containing individual TQLs have been loaded correctly, you can look them up in the Modeling Studio. Navigate to:

a. **Administration > RTSM Administration > Modeling > Modeling Studio**

- b. Select **Resource Type: Queries**. In the list, expand **Root** and scroll down to verify that `CIs_For_CIStatusChange_in_OMi` is present. Next, expand **Root > Integration > OMi_ Integration** to verify that the following packages are present:

```
OMi_Sync_Biz
OMi_Sync_BPI
OMi_Sync_Diag_TV
OMi_Sync_SiS
OMi_Sync_SiS_EMS
```

3. On your BSM or APM deployment, proceed as follows to check whether OMi is configured for single sign-on configuration. First, read out the values from the JMX console to determine whether further steps are required:

- a. For BSM versions 9.25, open the JMX console on your BSM gateway server by typing in a web browser:

```
http://localhost:8080/jmx-console/HtmlAdaptor?action=inspectMBean&name=Foundations%3Aservice%3DInfrastructure+Settings+Manager
```

- b. For BSM versions 9.26 or APM 9.30, open the JMX console on your BSM gateway server by typing in a web browser:

```
http://localhost:29000
```

Navigate to **Foundations > Foundations: service=Infrastructure Settings Manager**

- c. Find the method `java.lang.String getGlobalSettingValue()`.
- d. Change `contextName` to `SingleSignOn`.
- e. Change `settingName` to `lw.sso.configuration.xml`.
- f. Click **Invoke**.

In the resulting output, search for the string `omi`. If the string `omi` is present twice, your deployment is configured correctly and no further steps are required.

4. If the resulting output does not contain the string `omi`, BSM is not yet correctly configured for integrating with OMi. In this case, you must append the necessary data:
- a. On your BSM Gateway Server, copy and paste the entire result output in a text editor and append the following URLs between the `<restURLs>` and the `</restURLs>` tags:

```

<url>./topaz./omi./integration.*</url>
<url>./topaz./acweb.*</url>
<url>./topaz./personalization.*</url>
<url>./topaz./bsmLight.*</url>
<url>./topaz./ldapContext.*</url>
<url>./topaz./bsmLight./BPM.*</url>

```

- b. Also append the following between the <inbound> and </inbound> tag:

```

<service service-pattern=
".*/topaz./omi./integration.*" service-type="rest">
<in-lwssso refid="ID000001"/>
<in-custom
classname="com.mercury.topaz.reportsExt.login.BsmLwSsoBasicAuthHandler"/>
<in-lwsssoAutoCreate refid="ID000002"/>
</service>

```

- c. Copy the entire content from the two steps above.
- d. Open the JMX console on your BSM gateway server by typing in a web browser, preferably Firefox:

```

http://localhost:<port>/jmx-
console/HtmlAdaptor?action=inspectMBean&name=Foundations%3Aservice%3DInfrast
ructure+Settings+Manager

```

For BSM 9.25, <port> is 8080.

For BSM 9.26 and APM 9.30, <port> is 29000.

- e. Find the method **void setGlobalSettingValue()**.
- f. Change the **contextName** to SingleSignOn.
- g. Change the **settingName** to lw.sso.configuration.xml.
- h. Paste the new content into the **Value** field.
- i. Click **Invoke**.
- j. Restart the Mercury AS process.

Note: In a distributed environment, you must manually establish a trust relationship between your BSM and OMi systems. Run the following command on the BSM data processing server:

```
<OMi_HOME>/opr/bin/BBCTrustServer.[bat|sh] <FQND of OMi data processing server>
```

(RTSM only) Step 1: Install the UCMDB Data Flow Probe

If you plan a direct integration between BSM-OMi (no external UCMDB) to integrate BSM CIs directly into the RTSM, complete the following steps. If you plan to synchronize topology from BSM via an external UCMDB, skip these steps and instead begin with "[\(external UCMDB only\) Step 1: Prepare the topology synchronization](#)" on page 21.

The UCMDB Data Flow Probe pulls data from BSM to OMi. To install the UCMDB Data Flow Probe for OMi:

1. Get the UCMDB Data Flow Probe installation bits from the OMi media kit. The UCMDB Data Flow Probe must be of the same version as the RTSM that OMi uses. The UCMDB Data Flow Probe can be installed on either the OMi gateway server or data processing server. For more details on the installation of the Data Flow Probe, see the Data Flow Probe ReadMe on the media kit.
2. Install the UCMDB Data Flow Probe according to the instructions in the *UCMDB Data Flow Probe Installation Guide*. Make sure:
 - The UCMDB Data Flow Probe is connected to OMi.
 - **HP BSM** is selected as the application server.
 - The OMi gateway server or virtual server name is specified.
3. Set credentials so that the domain name appears in a drop-down list during configuration of the connected server:
 - a. Navigate to:
Administration > RTSM Administration > Data Flow Management > Data Flow Probe Setup
 - b. Select **DefaultDomain(Default)** and expand **Credentials** to go to **Generic Protocol**.
 - c. Click  **New** in the **Generic Protocol** pane to open the **Generic Protocol Parameters** wizard.

- d. Leave the default values in the **General** section.
 - e. Enter the user name and password of one of the following in the **Generic** section:
 - BSM user who has SDK permission and is allowed to perform synchronizations
 - BSM administrator
 - Integration user (as described in "[Step 4: Create the Integration User](#)" on page 26)
4. Start the Data Flow Probe before integrating BSM, by using

```
<INSTALL_DIR>/UCMDB/DataFlowProbe/bin/gateway.bat|sh start.
```

To see whether the UCMDB Data Flow Probe started successfully, check the following log file :

```
<INSTALL_DIR>/UCMDB/DataFlowProbe/runtime/log/WrapperProbeGw.log
```

Allow approximately 10 minutes for this process to finish as the Data Flow Probe is uploading a large number of files from the RTSM.

5. Increase the RTSM timeout in these two places if network latency is likely:

Note: The JMX Console can only be used remotely when its use is configured in BSM or OMi respectively. For information on how to configure your JMX Console remotely, see the *OMi Administration Guide*.

To log in the JMX Console, use the user name `sysadmin` and the password `admin`.

- a. On your OMi deployment, open the RTSM JMX console in a web browser:

```
http://localhost:21212/jmx-console/.
```

Click **UCMDB:service=Settings Services**.

Click **setSettingValue**.

For **customerID**, enter value 1.

For **name**, enter `task.DataAccess.Manager.getAdapterClassesConfig.timeOut`.

For **value**, enter the increased RTSM timeout in milliseconds (default is 20000).

- b. Also, in the RTSM JMX console `http://localhost:21212/jmx-console/HtmlAdaptor`,

Click **UCMDB:service=Settings Services**.

Click **setSettingValue**.

For **customerID**, enter value 1.

For **name**, enter `configuration.remote.action.timeout`.

For **value**, enter the increased RTSM timeout in milliseconds (default is 35000).

(external UCMDB only) Step 1: Prepare the topology synchronization

If you plan to synchronize topology via an external UCMDB, follow these steps to synchronize CIs between BSM, OMi, and the UCMDB. In this case, HPE advises that you use the external UCMDB as Global ID generator.

Make sure that the Data Flow probe has been installed on the UCMDB server.

If you plan to integrate BSM CIs directly into the RTSM, see "[\(RTSM only\) Step 1: Install the UCMDB Data Flow Probe](#)" on page 19.

This section includes:

- "[Task 1: Create Integration Point in UCMDB for BSM](#)" below
- "[Task 2: Create Integration Job to pull CIs from BSM](#)" on the next page
- "[Task 3: Create Integration Point in UCMDB for OMi](#)" on the next page
- "[Task 4: Create Integration Job to Push CIs to OMi](#)" on page 23
- "[Task 5: Verify the Topology Synchronization](#)" on page 24

Task 1: Create Integration Point in UCMDB for BSM

Create an integration point in the UCMDB for BSM:

1. In the UCMDB, go to:

Managers > Data Flow Management > Integration Studio

2. Click **New Integration Point** or **Edit**, enter a name and description of your choice, and select the adapter: **UCMDB 9.x**
3. Enter the following information for the adapter:
 - **Hostname/IP:** *<gateway server hostname>*
 - **Port:** *< 80 or 443 depending on your protocol>*

- **Protocol:** <communication protocol>
 - **Remote Machine State:** Actual
 - **Push Back Ids For Population:** Enabled
 - **CMDB State (Data Push):** Actual
 - **Data Flow Probe:** CMDB
4. Specify the credentials for the user you created to access the BSM system.
 5. Click **OK**, then click the **Save** button above the list of the integration points.

Task 2: Create Integration Job to pull CIs from BSM

Next, create an integration job that will pull the CIs from BSM based on the TQLs specified:

1. Select the Integration Point you created in Step 1. Click the **Population** tab on the right pane, and click **Create New**.
2. Click  **Add** and go to **Root > Integration > OMi_integration**.
3. Choose the following five TQLs (running order does not matter for this integration):
 - OMi_Sync_Biz
 - OMi_Sync_BPI
 - OMi_Sync_Diag_TV
 - OMi_Sync_SiS
 - OMi_Sync_SiS_EMS

Note: The required TQLs must reside on the BSM system, not on the external UCMDDB. They can be imported to BSM. For details, see ["Before You Begin: To integrate a BSM deployment that has been upgraded from BSM 9.24 \(or earlier\)"](#) on page 14.

4. Select the check box **Allow Integration Job to delete removed data**.
5. In the **Scheduler Definition** section, define the job schedule.

Task 3: Create Integration Point in UCMDDB for OMi

Create an integration point in the UCMDDB for OMi:

1. In the UCMDB, go to:
Managers > Data Flow Management > Integration Studio
2. Click **New Integration Point** or **Edit**, enter a name and description of your choice, and select the adapter: **UCMDB 10.x**
3. Enter the following information for the adapter:
 - **Hostname/IP:** *<gateway/LB server hostname>*
 - **Port:** *< 80 or 443 depending on your protocol>*
 - **Protocol:** *<communication protocol>*
 - **Remote Machine State:** Actual
 - **Push Back Ids for Population:** Enabled
 - **Push Back Ids for Push:** Disabled
 - **CMDB State (Data Push):** Actual
 - **Data Flow Probe:** CMDB
4. Specify the credentials for the user you created to access the OMi system.
5. Click **OK**, then click the **Save** button above the list of the integration points.

Task 4: Create Integration Job to Push CIs to OMi

Next, create an integration job that will push the CIs from the UCMDB to OMi based on the TQLs specified:

1. Select the Integration Point you created in Step 3. Click the **Data Push** tab on the right pane, and click **Create New**.
2. Based on the CIs you would like to push from the UCMDB to OMi, use an appropriate TQL. As a starting point, you can use `RTSMtoCMSSync`.

If you use the `RTSMtoCMSSync` TQL as a starting point, you must make sure that the correct attributes for your integration are synchronized. Right click any node and select **Properties** to bring up the **Query Node Properties** window. On the **Element Layout** tab, select **Select attributes for layout**. In the **Conditions** section, adjust the conditions in order to include the attributes you need. If you would like to include all attributes, set **Attributes condition** to **All**.

Task 5: Verify the Topology Synchronization

Run the integration jobs and verify the integration results in the UCMDB Manager.

Step 2: Set Up TLS and Root Certificates

If you have hardened your OMi server, you must configure TLS in the Data Flow Probe and establish trust between the Data Flow Probe server and the OMi server.

1. Enable TLS in the DFP to connect to OMi:
 - a. Open `<DFP_HOME>\conf\DataFlowProbe.properties`.
 - b. Change the property `appilog.agent.probe.protocol` from HTTP to HTTPS.
 - c. Change the property `serverPortHttps` from 8443 to 443.
2. Establish trust between the DFP server and the OMi server:

- a. Import issue of OMi server certificate into JRE's trust store:

```
<UCMDB_HOME>\UCMDB\DataFlowProbe\bin\jre\bin\keytool -import -trustcacerts -  
file <CA cert>.pem -alias <ca cert alias> -keystore
```

```
<UCMDB_HOME>\UCMDB\DataFlowProbe\bin\jre\lib\security\cacerts
```

- b. Import issue of BSM server certificate into JRE's trust store:

```
<UCMDB_HOME>\UCMDB\DataFlowProbe\bin\jre\bin\keytool -import -trustcacerts -  
file <CA cert>.pem -alias <ca cert alias> -keystore
```

```
<UCMDB_HOME>\UCMDB\DataFlowProbe\bin\jre\lib\security\cacerts
```

3. Restart the DFP server.

You must import the root certificate from your certification authority to the OMi and the BSM data processing servers and gateway servers.

1. On the OMi gateway and data processing servers, run the following command:

```
<OMi_HOME>\bin\opr-cert-mgmt.[bat|sh] -import <alias> <path>
```

2. On the BSM gateway and data processing servers, run the following command:

```
<BSM_HOME>\JRE\bin\keytool.[exe, sh]-import -trustcacerts -file <Root  
Certificate of your Certificate Authority> -alias <any name> -keystore <BSM_  
HOME>\JRE\lib\security\cacerts
```

3. Restart the OMi and BSM gateway and data processing servers.

Step 3: Configure Lightweight Single Sign-On

Note: If you use IDM SSO, you must temporarily switch to Lightweight Single Sign-On and restart OMi for the change to take effect, before proceeding with the integration. Once the integration is up and running, you can switch back to IDM SSO.

A limitation after switching back to IDM SSO:

- Once established, the data flow probe will store credentials in its cache and does not need LW SSO. However, if you want to change the credentials used by the data flow probe to connect to APM, or if the data flow probe cache is cleared, you must temporarily switch back to LW SSO and configure the data flow probe.

Aligning Lightweight Single Sign-On on both deployments enables you to view BSM components in the OMi user interface.

Set up Lightweight Single Sign-On (LW-SSO) and align `initString` on both systems. It is good practice that the product added to the existing environment gets the same key as the already existing deployments. For example, if OMi is added last, the key needs to be changed in OMi. If more than one BSM server is connected to the same OMi server, change the `initString` parameter on the BSM side.

Note: LW-SSO will not work if TLS is enabled for one product but not the other. Make sure that the TLS setup is consistent between products before trying to configure LW-SSO.

- In OMi:
 - a. Navigate to Authentication Management:

Administration > Users > Authentication Management
 - b. In the Single Sign-On Configuration section, click  **Edit** to open Single Sign On Editor panel.
 - c. In the Single Sign On Editor panel, select **Lightweight**.
 - d. Copy the **Token Creation Key (initString)** value.

- e. Click **Save** to save your configuration.

For details on configuring LW-SSO, see the *OMi Administration Guide*.

Note: If you are using OMi 10.61 and this is the first time you integrate the system with APM, you must disable useHTTPOnly for the LWSSO cookie by running the following command:

```
Windows: <OMi_Home>\opr\support>opr-jmxClient.bat -r -s localhost:4447 -b  
"Topaz:service=LW-SSO Configuration" -m setUseHTTPOnly -a false
```

```
Linux: <OMi_Home>/opr/support>opr-jmxClient.sh -r -s localhost:4447 -b  
"Topaz:service=LW-SSO Configuration" -m setUseHTTPOnly -a false
```

This is *not* required if you upgraded to OMi 10.61 from a previous version and already had set up an integration with APM.

- For BSM versions 9.25 and higher and APM version 9.30, perform the following in your BSM or APM deployment:
 - a. Navigate to the gateway server and open via browser <http://localhost:29000/>
 - b. Insert your credentials which you configured in the Configuration Server Wizard.
 - c. Search for **Topaz:service=LW-SSO Configuration**.
 - d. Paste the **Token Creation Key (initString)** value that you copied from OMi in the previous instructions.
 - e. Click **Set** to save your changes.

Step 4: Create the Integration User

Note: This step is not relevant for APM 9.30 or if you use user admin. For APM 9.30, see "[\(APM 9.30 only\) Creating a Standard User with Integration User Role](#)" on page 28.

In this step you will begin by creating your integration user in the BSM JMX console, and then configure the user by using the BSM user interface.

1. In your BSM deployment (DPS), go to the jmx console: <http://localhost:21212/jmx-console>
2. Select **UCMDB:service=Security Services**.
3. Go to **createIntegrationUser()** and create your integration user using the following values:

```
customerID: 1
userName: <integration user name>
password: <pwd>
dataStoreOrigin: <any value>
```

4. Click **Invoke**.
5. Invoke the **getUsersList MBean** with **customerID=1** to check if the user is shown in the list of integration users.
6. In your BSM deployment go to **Admin > Platform > User and Permissions > User Management**.
7. Select **Create New Users** with the same user name as the integration user created previously.
8. Click the icon of the user you have just created.
9. Go to the tab **Permissions** tab.
10. Grant the **Administrator** role to your integration user.
11. Click **Apply Permissions** to finish.

Note: You must wait at least ten minutes for the changes to take effect. You can define this in the following setting:

Navigate to: **Admin > Platform > Setup and Maintenance > Infrastructure Settings**

Select the context: **Applications - Operations Management**

Scroll to **Operations Management - Topaz Authorization Service Settings**

Click the edit button in the line **Refresh Interval** and enter 10 in the field **Value** in the **Edit Setting** dialog box.

How to Change the Integration User's Password

When you change the integration user's password on the BSM system, the password must be updated in BSM User Management and in the OMi connected server. To change the integration user's password, perform the following steps:

1. In your BSM deployment (DPS), go to the jmx console: <http://localhost:21212/jmx-console>
2. Select **UCMDB Service:Security Services**.
3. Go to **changeIntegrationUserPassword()** and use the following values:

```
customerID: 1
userName: <integration user name>
password: <new pwd>
```

4. Click **Invoke**.
5. In your BSM deployment go to **Admin > Platform > User and Permissions > User Management**.
6. Select your integration user in the Groups/Users list.
7. On the **General** tab, enter the new password in the Password and Confirm Password fields. Click **Apply**.
8. In your OMi deployment, navigate to **Administration > Setup and Maintenance > Connected Servers**.
9. Edit the APM connected server. In the Server Properties section, enter the new password in the Password and Verify password fields and save.
10. In the Synchronization section, re-trigger steps 1-3 to avoid any inconsistencies after the password change.

(APM 9.30 only) Creating a Standard User with Integration User Role

Note: Do not perform this step if you upgraded from BSM 9.2x and already created an integration user. It will be created automatically as part of the upgrade.

For APM 9.30, you must create a standard user with SDK access permissions.

1. Navigate to **APM UI > Admin > Platform > Users and Permissions > User Management**.
2. Create a new user.
3. Click the **Permissions** tab, and assign an appropriate role to the user.
4. In **Managers > Administration > Security Manager**, navigate to the Customize tab. Grant the created user **Access to SDK** permission.

Step 5: Set Up an APM Connected Server in OMi and Complete the Integration

Note: This step will auto-detect the target APM version. BSM 9.25 and higher and APM 9.30 are supported.

In the previous steps, you set up your environment to enable the APM Integration. In the following section, you will perform the integration. In this step, you enable the following:

- Configure and initiate topology synchronization.
- Initiate event, status, and UI integration.
- Initiate status and downtime synchronization.

To integrate the configuration items (CIs) that exist in BSM to OMi, perform the following steps:

1. Make sure port 383 is open.
2. On your OMi deployment, navigate to:
Administration > Setup and Maintenance > Connected Servers
3. In the central Connected Servers pane, click ✖ **New** and select **APM**. Alternatively, you can click ✖ **New** in the Application Performance Management (APM) area in the right pane.

The Create APM Server panel opens.

4. In the General section, enter a display label, an identifier (a unique internal name if you want to replace the automatically generated one), and, optionally, a description of the connection being specified.
5. In the Server Properties section, complete the following information:
 - a. Enter the fully qualified domain name of the Application User URL setting. To find this FQDN, follow these steps:
 - i. On your BSM deployment, navigate to **Admin > Platform > Setup and Maintenance > Infrastructure Settings**.
 - ii. Select **Foundations** and use the list to set the administration context to **Platform Administration**.
 - iii. Go to the **Platform Administration - Host Configuration** section.
 - iv. Copy the FQDN part of the URL in the Value field of the Default Virtual Gateway Server for Application Users URL entry. The FQDN part of the URL is the URL without `https://` and `<port number>`.
 - v. Paste this FQDN part into the Fully qualified domain name field.
 - b. Enter the user name and password of your integration user.
 - c. *Optional*. If the URL path has changed, you must add the new URL, otherwise leave this field empty.
 - d. Enter the port number of the APM server. The default port value is automatically inserted and can be restored by clicking **Set default port**.
 - e. Make sure the **Use secure HTTP** check box is selected if you are using secure communication (default).
 - f. Select the **Sync event updates back to APM servers** check box if you want to synchronize event updates back to the APM server.
6. In the Synchronization section, complete the following information:

Note: If you plan to synchronize topology from BSM via an external UCMDB, skip this step, as CIs have already been synchronized during "(external UCMDB only) Step 1: Prepare the topology synchronization" on page 21. You can proceed directly to "Continue the Setup of BSM in OMi and Start the Integration" on page 33.

If you integrate BSM CIs directly into the RTSM, click the box on the left of **Step 1: Topology**:

- a. If the **Use OMi as Global ID Generator** option is editable, select your desired global ID generator. If the **Use OMi as Global ID Generator** option is grayed out, a global ID generator already exists in your environment. In this case, proceed with selecting your Data Flow Probe.
- b. Select the name of your Data Flow Probe from the drop-down list. Then specify the domain name that was used during the Data Flow Probe installation.
- c. Make sure that the **Activate after save** check box is selected if you want to enable the server connection immediately.
- d. Click **Create** to start the topology synchronization and to create the APM integration point.

Verify the Integration

The previous procedure involves pulling the topology of the CIs from BSM into OMi. *This can take some time, and in very large environments can take several hours.*

The following section describes how to verify that the synchronization is complete, in order to continue with the integration setup.

1. On the OMi server, navigate to:

Administration > Setup and Maintenance > Connected Servers

2. Check the status of the last executed job in the pane to the right of your connected server. Wait until one integration job runs successfully before continuing. To update the status, click  **Refresh**.

Additionally, you can check the status of the integration jobs in the RTSM Integration Studio:

3. Navigate to:

Administration > RTSM Administration > Data Flow Management > Integration Studio

On the left-hand side of the Integration Studio, you see a list of all integration points.

4. Select the APM2OMi integration point. You see two integration jobs:

`sync_continuous`



`sync_initial`

Wait until at least one of these completes before continuing.

You can start manually either integration job by clicking the **full synchronization** icon or the **delta synchronization** icon.

Continue the Setup of BSM in OMi and Start the Integration

In this section, you configure event, status, and UI integration.

1. On the OMi server, navigate to:
Administration > Setup and Maintenance > Connected Servers
2. Double-click your APM connected server to open the Edit APM Server panel. Alternatively, you can select it and click  **Edit**.
3. Go to the Synchronization section, and perform the following:
 - a. Select the check box next to **Step 2: OMi to APM Setup**. This step integrates UI mash-up components and communication certificates and configures OMi server settings in APM.
 - b. Click **Save** to complete this step.
4. Go back to **Administration > Setup and Maintenance > Connected Servers**.
5. Double-click your APM connected server to open the Edit APM Server panel. Alternatively, you can select it and click  **Edit**.
6. Go to the Synchronization section, and perform the following:
 - a. Select the check box next to **Step 3: Synchronization**. CIs in OMi are updated with KPI status from the corresponding CIs in APM and downtime definitions are copied from APM to OMi.
 - b. *Optional.* Select the **Synchronize downtime** check box to allow one time initial synchronization of BSM downtime to OMi, in order to help start managing all downtimes on the OMi side.
 - c. Click **Save**.
7. *This step applies to BSM 9.2x only, not to APM 9.30.* In the Test Connection section, click  **Run Test** to check that the specified connection attributes are correct. If an error message is displayed, correct the connection information, and retest the connection.

(APM 9.30 only) Step 6: Enabling Alert and Status Forwarding

For APM 9.30, in order to enable alert and status forwarding, you must manually deploy the OprEvent template on the OMi side.

1. On your OMi deployment, navigate to:
Administration >Monitoring > Policy Templates.
2. Expand the following:
Templates grouped by type > Events > Event from REST web service
3. Click **OprEvent** template.
4. Click **Assign and Deploy Template.**
5. Select all OMi GW systems.
6. Click **Next.**
7. Click **Next.**
8. Click **Finish.**

(APM 9.30 only) Step 7: Creating OMi Authentication User Name and Password

As part of the new integration between APM and OMi, embedded OMi under APM no longer exists, and the integration relies on connecting to OMi via REST.

Creating OMi Authentication User Name and Password

APM 9.30 users need to set an OMi user name and password for sending events from APM to OMi

1. Run the following command on the agent or OpsCx instance to which the policy was deployed in "[\(APM 9.30 only\) Step 6: Enabling Alert and Status Forwarding](#)" above. This sets the user name/password for the webservice that APM is using (same user/password of course as in APM):

```
<InstallDir>/opr/bin/opr-rest-ws-policy-configuration.{bat,sh} -enable_auth -credentials -  
username <username> [-password <password>]
```

2. In APM, select **Admin > Platform > Setup and Maintenance > Infrastructure Settings**.
3. Select **Foundations**.
4. Select **OMi Integration**.
5. In the OMi Integration - General Settings table:
 - Locate **Login** and enter the user name you used in step 1 to create your OMi authorization user name.
 - Locate **Password** and enter the password you used in step 1 to create your OMi authorization password.

Use the user name and password that you created above.

6. Save your changes.

(APM 9.30 only) Step 8: Importing Certificates for REST Service

Note: This step is only required if a secured connection is required. If a secure connection is not required, complete the instructions in "[\(APM 9.30 only\) Step 9: Using Unsecured http REST Access](#)" on the next page.

To import the certificates:

1. On the OMi agent or OpsCx instance where the policy was deployed, retrieve the OMi certificates for the REST service, by entering **ovcert -list** in a cmd window.

Note: The certificate to be trusted is the one issued on the agent or OpsCx instance where the policy was deployed in "[\(APM 9.30 only\) Step 6: Enabling Alert and Status Forwarding](#)" on the previous page. For example, if the policy was deployed on the OMi gateway server, then import the certificate from the OMi gateway server.

2. Export the certificate by using the following command:

```
ovcert -exporttrusted -file <location of file> -alias <trusted certificate name>
```

For example:

```
ovcert -exporttrusted -file c:\trust.pem -alias CA_c37b8bd5-5b9b-4626-be18-  
c78ef76040e5_2048
```

where

c:\trust.pem is the location for the file which will be exported

CA_<UUID>_2048 is the CA certificate of OMi (where <UUID> is the ID retrieved when using the **ovcoreid -ovrg server** command).

3. Import the certificate by running the following command from the **JRE64/bin** folder on the APM gateway and data processing servers:

```
keytool.exe -import -trustcacerts -keystore ..\lib\security\cacerts -storepass changeit -alias  
ANYCERTID -file <location of file>
```

4. Restart the APM server on both the gateway and data processing server.

(APM 9.30 only) Step 9: Using Unsecured http REST Access

Note: This step is optional only if a secured connection is not required. If a secure connection is required, complete the instructions in "[\(APM 9.30 only\) Step 8: Importing Certificates for REST Service](#)" on the previous page.

The default communication method is https. In order to use http, perform the following:

1. Access APM JMX, for example:

```
http://<localhost>:29000/mbean?objectname=OMi-Integration%3Aservice%3DSettings
```

2. Enter the URL to connect to OMi by using **setOmiUrl** method, for example:

```
http://<OMi GW>:30005
```

3. To view the settings, use the method **getOmiUrl**.

Step 10: KPI Assignments in OMi

Note: This step is not relevant if you upgraded to APM 9.30 from BSM 9.25 or BSM 9.26, and already configured this integration.

BSM sends KPI status information for certain CI types to OMi. Per default, this is done for Business Application CIs, but BSM can also send KPI status changes for other CI Types. Such a KPI status change is sent to OMi in the form of a special event with a Health Indicator (HI) that contains the KPI name and the new status. These KPI change events are processed separately from other events and are not stored in the event database.

When a KPI change event arrives in OMi, the following is triggered:

- Assuming an “Application Availability KPI change event” arrives, a corresponding Health Indicator “Application Availability” is created automatically (for the corresponding CI type).
- If the CI Type does not yet have a KPI assignment for that specific KPI, then a new KPI assignment is created automatically that uses the HI “Application Availability” to set the KPI “Application Availability” and no further steps are necessary. The KPI status of the “Application Availability” KPI will be synchronized automatically.
- If the CI Type already has a KPI assignment, then the KPI assignment needs to be adjusted manually.

Because OMi already has an out-of-the-box KPI assignment for Business Application CIs, you must perform the following manual steps.

1. In OMi, navigate to **Administration > Service Health > CI Status Calculation > KPI Assignments**.
2. Select the CI Types **ConfigurationItem > BusinessElement > BusinessApplication**.
3. Pause the assignments for BPM and RUM. These are predefined KPI assignments, which are not suitable for an OMi system.
4. Click ✖ **New** to open the Create KPI Assignment panel. Specify an appropriate display name and, optionally, a description.
5. In the **KPI Configurations** section, click ✖ **New KPI Configuration**.
6. Select the KPI definition Application Availability. Leave the default values in the Business Rule and Calculated Based On fields, and add the Related HI **Application Availability**. Click ✓

Apply.

7. Repeat Steps 5 and 6 for the KPI definition **Application Performance**, and the Related HI **Application Performance**. Check **Activate after save** and create the KPI Assignment.
8. In the CI Type selection pane, select the CI type BusinessElement and click **Apply all rules** to update all CIs.

If a CI Type already has a KPI assignment for the KPI that received a change event from the APM system, the new HI needs to be added manually.

1. In OMi, navigate to **Administration > Service Health > CI Status Calculation > KPI Assignments**.
2. Select the appropriate CI Type.
3. Update the existing KPI assignment and in the KPI Configurations section, include the new HI which represents the KPI status change.
4. Save the KPI Assignment.
5. In the CI Type selection pane, select the appropriate CI Type and click **Apply all rules** to update all CIs.

Additional APM-OMi Integration Configurations

Integrating BSM with a new, second instance of OMi

To integrate BSM with a new instance of OMi, after disconnecting the original OMi system from BSM, perform the following:

Note: It is not possible to simultaneously connect two OMi systems to one BSM system. The original OMi system must first be disconnected before connecting a new OMi instance to BSM.

1. Connect BSM to OMi and execute the topology synchronization following the steps in "[Step 5: Set Up an APM Connected Server in OMi and Complete the Integration](#)" on page 29.
2. After the topology synchronization, go to the **OMi Integration Studio** and select the Integration Point with the name "APM2OMi <name of connected server>".
3. On the right side, select one of the two sync_* jobs.

4. On the toolbar, click **Clear caches....** After completion, click **Full synchronization.**
5. The global IDs generated by the new OMi instance are now properly pushed to BSM.

BSM Status Forwarding Settings

In BSM, additional settings control CI status forwarding from BSM to OMi. In most cases, you do not need to change these settings. In BSM, navigate to **Admin > Platform > Setup and Maintenance > Infrastructure Settings.** Select **Foundations: OMi Integration.** Edit the settings as desired.

For example, the **HI Statuses Sync - CITs configuration file** in the **OMi Integration - General Settings** section is an XML file that defines the CITs with HIs that should be forwarded to OMi. If desired, you can edit this XML file to change the CITs whose HIs will be forwarded from BSM to OMi.

Troubleshooting for the APM-OMi Integration

Adjust KPI assignments

To adjust and troubleshoot KPI assignments in OMi, perform the following:

1. In BSM, create a KPI assignment with the **Application Availability** KPI type, and any of the available HIs.
2. Send an event on OMi by using the `sendEvent.bat | .sh` tool. The event should contain a severity with the new state of the KPI, a category `KpiStatusChange`, an ETI Hint containing only the name of the affected KPI, and a `RelatedCiHint` with a valid hint for the CI resolver.

Example: In this example, `Application Performance` has been chosen as the assignment in step 1.

```
<OMi_HOME>/opr/support/sendEvent.[bat|sh] -t example -c KpiStatusChange -s
Normal -rch GUCMDB:<GlobalCi_Of_BusinessApplication_CI> -eh "Application
Performance"
```

3. In OMi, navigate to **Administration > Service Health > KPI Assignments.**
4. In the left pane, select **ConfigurationItem > BusinessElement > BusinessApplication.**
5. In the central pane, select the assignment that contains **Application Availability, Availability Performance**, and click  **Edit** to edit the KPI assignment.

6. In the Edit KPI Assignment panel, navigate to the KPI Configurations section.
7. Select the **Application Availability** KPI, and click  **Edit**.
8. In the Related HIs field, add the Application Availability HI to the list of selected HIs.

Note: If you do not see any HIs in the Related HIs drop-down menu, wait until CI status changes are from BSM to OMi. The forwarding of CI status changes is triggered by the first change of a CI status of any CI that is present in BSM and has been synchronized to **OMi**. These adjustments can only be done when a corresponding CI status event has been received in OMi. Otherwise, you will not see the Application Performance or Application Availability HIs.

9. Click **Save**.
10. Perform steps 7 to 10 for the Application Performance HI and KPI.
11. Click **Apply all rules** for the assignment to take effect on existing CIs.

Failed to re-direct topology from BSM9.2x to OMi 10.11

If you integrate SiteScope with BSM 9.26 for OMi features (topology and events) and upgrade BSM 9.26 to OMi 10.11, the integration between OMi and SiteScope does not behave as it used. You will not see the new topology and events from your existing SiteScope in the new upgraded OMi.

Workaround: Reset the BSM integration in SiteScope and delete the integration in OMi10.11's **Connected server** and re-integrate SiteScope from OMi10.11.

To reset the BSM integration in SiteScope:

1. Log in to SiteScope with your user ID and password.
2. Go to **Preferences > Integration Preferences**.
3. Edit the existing BSM integration.
4. Click the **BSM Preferences Available Operations** tab and click **Reset**.
5. Click **OK**. The BSM integration is deleted.

Topology synchronization fails with APM 9.30

If LDAP was configured on the APM 9.30 system, it's possible that the integration user's password was not correctly saved in the RTSM database, which will cause the topology integration to fail. To manually update the integration user's password in the RTSM, do the following:

1. Log in to APM as an administrative user.
2. In the same browser in a different tab, connect to the RTSM with `http://<APM>:21212`, and select **User Management**.
3. Find the integration user and select **Change Password**.
4. Fill in the new password (you can leave the old password blank).
5. Save the new password and trigger the topology synchronization again.

Integration Fails with Trust for event synchronization failed error

If you are running the OMi-APM integration and APM is using IIS and the OMi-APM integration fails with a **Trust for event synchronization failed** error, perform the following on all APM gateways running on IIS.

1. From the Start menu, click **Administrative Tools > Internet Information Services (IIS) Manager**.
2. In the Connections pane, click **Default Web Site**.
3. In the right pane, double-click **Request Filtering**.
4. Click the **HTTP Verbs** tab.
5. In the right pane, right-click and select **Allow Verb**.
6. In the Allow Verb dialog box, enter **PUT** and click **OK**.
7. Click the **File Name Extensions** tab.
8. In the right pane, right-click and select **Allow File Name Extension**.
9. In the Allow File Name Extension dialog box, enter **group** and click **OK**.
10. Reset IIS.

Chapter 4: How to Display BSM Data in OMi

BSM user interface components can be directly integrated into OMi **Workspaces** to view and drill down to detailed BSM information.

Note: All APM systems connected to OMi must be the same version and/or provide the same features.

Create a BSM User Interface Element

1. On the OMi server, navigate to:
Workspaces > My Workspace
2. Create a new page:
 - a. Click the **New Page** icon on the top left of the toolbar.
 - b. Click **Add Component** in the graphics on the left to open the **Component Gallery**.
 - c. Select APM from the list on the left of the **Component Gallery** to display the BSM components.
 - d. Double-click the desired BSM.

It is not possible to apply a filter to the user interface components from the BSMs that are displayed in OMi.

The following BSM use cases are supported:

1. Selecting BSM components from the OMi components gallery and opening them in a frame inside the OMi components dashboard.
2. Wiring in case of a CI change. For example, a CI 1 is selected and its associated data is displayed. If now a different CI, CI 2, is selected, the data displayed changes to data associated with CI 2.

The following components are currently available in OMi:

- **Platform Components**

- Top View

Hierarchy View

APM Based Impact

- **BPM Components**

Application Summary

BPM Performance Matrix

BPM Performance Status

BPM Error Summary Distribution by Category/Type

Application Health Business Summary

BPM Error Summary Distribution by Location/BPM Custom Attributes

BPM Error Summary Distribution by Transaction

Metrics Over Time

- **RUM Components**

Application Health Performance

Application Health Availability

RUM Event Count By classification

- **SiteScope components**

Cross Performance Reports

SiteScope Multi View

- **Service Level Management components**

SLA Summary

Current Status Snapshot

Historic Status Snapshot

Chapter 5: How to Customize BSM-OMi Integration

There are several OMi Integration Infrastructure setting that will enable you to customize your BSM-OMi Integration.

To customize the BSM-OMi integration:

1. In the BSM application, select **Admin > Platform > Setup and Maintenance > Infrastructure Settings**.
2. Select **Foundations > OMi Integration**.
3. Configure the OMi Integration settings as follows:
 - o **HI Statuses Sync - CITs configuration file.** Define which CI types to include in the HI status synchronization. The following CI types are included by default: **node**, **running_software**, **business_application**. You can add additional CI types or remove existing ones. The CI type name is the internal name (not the display name, for example, the display name is **business_application**, not **Business Application**). You can view the CI type name under **RTSM > CIT manager**.
 - o **KPIs list per CI type (Business Application).** Define which KPI to use for synchronizing the KPI status change. The following CI type is included by default: **Application Availability** and **Application Performance** for CI type **business_application**. You can add additional KPIs and CI types or remove existing ones. Keep in mind that the TQL integration for topology synchronization jobs must be modified to cover the same CI type. If the CIs and the GUID are missing from OM, no status change will be reflected.
 - o **Events chunk size.** Size of chunk of events sent during initial KPI/HI synchronization. You can enter a number between 1 and 500.
 - o **Interval between session.** Interval between events chunks sending sessions (seconds). You can enter a number between 1 and 10.
 - o **Event forwarding CI Alert name if status improved.** Enter the event description that is generated when status changes and becomes better.
 - o **Event forwarding CI Alert name if status worsened.** Enter the event description that is generated when status changes and becomes worse.

In addition, you can use the tql - **CIs_For_CIStatusChange_in_OMi** to define which CI types to use to synchronize KPI status changes.

Chapter 6: How to Create and Forward End User Management Alerts to OMi

It is best practice to forward End User Management (EUM) related information to OMi. With EUM alerts, you can:

- Configure granular trigger conditions based event based triggers or time based triggers. For example, you can send an alert when a transaction fail or exceeds a specified amount of time.
- Filter the alert by transaction, location, or mobile device
- Configure the notification frequency

By creating EUM alerts, you can pass critical Business Process Monitor (BPM) transactions and CIs that are not part of the integration to OMi. When you create EUM alerts you should tailor them according to your specific requirements. In the Actions tab, be sure to select the **generating event** alert action. Events that are created in this manner, are automatically forwarded to OMi as part of the integration predefined forwarding rules.

For information about creating and managing EUM alerts, see the *BSM Application Administration Guide*.

Part III: Operations Manager i - HPE SiteScope Integration

This part of the guide contains the following chapters:

- ["SiteScope Integration - Overview" on page 47](#)

This chapter provides the SiteScope integration overview.

- ["SiteScope Integration - Tasks" on page 48](#)

This chapter describes various tasks that you must perform to configure and use the SiteScope integration.

Information on setting up a SiteScope connected server, importing SiteScope templates, and troubleshooting the use of SiteScope templates in OMi is described in the *OMi Administration Guide*

Chapter 7: SiteScope Integration - Overview

SiteScope is an agentless monitoring solution that enables you to remotely monitor the availability and performance of your IT infrastructure (for example, servers, operating systems, network devices, network services, applications, and application components). The SiteScope integration with OMi has multiple parts, which can be enabled individually or in combination with one another. The parts of the integration described in this guide are:

- **Event integration:** SiteScope can forward events to OMi. For information, see ["Configure the event integration" on page 50](#).
- **Topology integration:** SiteScope can forward topology information to OMi. For information, see ["Configure the topology integration" on page 51](#).
- **Drilldown integration:** When SiteScope monitors are used to set the status of a configuration item (CI), you can drill down from the CI in OMi to a SiteScope monitor that contributes to the CI's status. For information, see ["How to Drill Down to SiteScope" on page 52](#).
- **Configuring and deploying SiteScope monitors from OMi:** OMi provides a script that enables you to import templates from a SiteScope server so that you can include them in aspects, thus allowing you to manage the configuration and deployment of SiteScope monitors from within OMi. For information, see ["Configuring and deploying SiteScope monitors from OMi" on page 48](#).

Chapter 8: SiteScope Integration - Tasks

This section describes the tasks that you must perform to configure and use the SiteScope integration:

- ["Configuring and deploying SiteScope monitors from OMi" below](#)
- ["Configure the event integration" on page 50](#)
- ["Configure the topology integration" on page 51](#)
- ["How to Drill Down to SiteScope" on page 52](#)
- ["How to Connect to a SiteScope Server That Requires TLS" on page 53](#)
- ["Setting up TLS between sisconfig and SiteScope runtime" on page 55](#)

Configuring and deploying SiteScope monitors from OMi

You can set up the OMi-SiteScope integration so that you can configure and deploy SiteScope monitors from within OMi. To set up this integration, follow these steps:

Note: To enable this integration for TLS, perform the steps in ["How to Connect to a SiteScope Server That Requires TLS" on page 53](#) and ["Setting up TLS between sisconfig and SiteScope runtime" on page 55](#).

1. Install the Operations Agent on the SiteScope system.

Install Operations Agent from the SiteScope installer package, or download it from the [HPE Software Support](#) (in the Search box, type "Operations Agent", select the relevant version, under Document Type, select Patches, and locate the installation file).

On Windows:

- a. Log in to the node with administrator privileges.
- b. Go to the directory where you extracted the contents of the ISO file.
- c. Run the following command to install the agent:

```
cscript oainstall.vbs -i -a
```

On Linux:

- a. Log on to the node with root privileges.
- b. Go to the directory where you extracted the contents of the ISO file.

- c. Run the following command to start the installation:

```
./oainstall.sh -i -a
```

For more detailed installation instructions, see the *Operations Agent Installation Guide*, available from the [HPE Software Support site](#).

Note:

- Use the `-includeupdates` installation to install Operations Agent with prepackaged hotfixes. For details, see the *Operations Agent Installation Guide*.

2. Configure the Operations Agent.

This task registers the `sisconfig` subagent process (used for Monitoring Automation to deploy monitoring to SiteScope), and installs the policy signing tool (used by SiteScope to install policies locally).

- a. Run the SiteScope Configuration Tool on the SiteScope server:

- On Windows: Select **Start > All Programs > HP SiteScope > Configuration Tool**.
- On Linux (graphic mode): Run `<SiteScope install Directory>/bin/config_tool.sh`
- On Linux (console mode): Run `<SiteScope install Directory>/bin/config_tool.sh -i console`.

For more details on using the SiteScope Configuration Tool, see the *HPE SiteScope Deployment Guide*.

- b. In the **Configure HP Operations Agent installed separately** option (**HP Operations Agent** option in console mode), select **Configure HP Operations Agent** to complete the installation of the Operations Agent.
- c. Restart SiteScope.
- d. If the agent is installed on a Red Hat ES Linux 6.0 environment, after installing the Operations Agent, check the installation status in the log files.

- i. In the SiteScope log, check if the installation completed successfully by searching for the results of `installOATask`.

Log file name: `HPSiteScope_config_tool.log`

Log file location on Windows platforms: `win- %temp%`

Log file location on UNIX/Linux platforms: `/temp` or `/var/temp`

- ii. In the Operations Agent log files:

Log file name: **`oainstall.log`**, **`oapatch.log`**

Log file location on Windows platform: %ovdatadir%\log

Log file location on UNIX/Linux platforms: /var/opt/OV/log

3. Set up the SiteScope system as a connected server on the OMi server. For more information on setting up a SiteScope connected server and on selecting the target SiteScope server for deployment, see the *OMi Administration Guide*.
4. Configure templates in SiteScope and import them. For information on importing templates from a SiteScope server and assigning SiteScope policy templates to remote servers, as well as for troubleshooting information, see the *OMi Administration Guide*.

Guidelines for Using Multiple SiteScope Monitors of Same Monitor Type

Follow these guidelines if you are deploying multiple SiteScope monitors of the same monitor type on the same host. These guidelines are important for accurate graphing of SiteScope metric data using OMi Performance Dashboard.

- Do not monitor the same metric from multiple monitors. It may randomly select one metric value over the other, causing errors.
- Ensure that the name of your SiteScope monitor follows this convention:

<monitor name> on <hostname>

For example, when monitoring a server named `sample.domain.com` with two separate Unix resource monitors for file system usage metrics and network usage metrics, name the two monitors as follows:

`File_system_usage` on `sample.domain.com` and `Network_usage` on `sample.domain.com`

- If you are using SiteScope templates to create monitors, follow this naming convention:

<prefix name> on %%host%%

Configure the event integration

1. Log in to SiteScope, and navigate to **Preferences > Integrations Preferences**.
2. Click **New Integration**, and in the resulting window select **HP Operations Manager Integration**.
3. Enter the FQDN of the OMi server.
4. Check the following boxes:

- a. **Enable sending events**
 - b. **Connect directly to BSM**
 - c. **Prefer events over metric in BSM Service Health (global preference)**
5. Uncheck the **Enable exporting templates to HP Operations Manager** box.
 6. Click **Connect** to activate the agent.

Note: If you have not configured certificate auto-granting, you must manually grant the certificate request in OMi:

- Navigate to **Administration > Setup and Maintenance > Certificate Requests**
 - Select the certificate request.
 - Click the **Grant** icon.
7. Click **Install Policies**, then click **Analyze** to verify the configuration.
 8. In the **Test Integration** section, enter a test message, and click **Send Test Message**. Then click **Send Test Event**. Click OK to close the window, then click OK in the following Disable Policy Result window. Verify that both events are in the OMi Event Browser.

Configure the topology integration

1. In OMi, create a connected server for the SiteScope server. For information on creating a connected server, see *OMi Administration Guide*.
2. Verify that the integration has been configured automatically in SiteScope:
 - In SiteScope, navigate to **Preferences > Integration Preferences**.
 - You will see a new BSM integration configured as a result of creating the connected server in OMi.
3. Configure all pre-existing monitors to set Service Health based on events.

Now that you have integrated SiteScope with OMi, any pre-existing monitors have been updated with an HPE Integrations Settings section. In this section, the BSM Service Health Preferences show Service Health is affected by Metrics. This setting must be changed to Events, so that events carry indicators to set Service health. To change the BSM Service Health Preferences from Metrics to Events:

- a. In the monitor tree, right-click the SiteScope container and select **Global Search and Replace**.
 - b. In the wizard, select all monitors. In the Choose Changes tab, check the **BSM Service health affected by** box and set the associated drop down list to **Events**.
4. Verify that the topology has been created in the RTSM.
- a. In OMi, navigate to **Administration > RTSM Administration > IT Universe Manager**.
 - b. Search for all node CIs. You should now see one or more new CIs created by SiteScope.
 - c. Troubleshooting: If topology is not appearing in the RTSM, you can check for errors in the SiteScope logs.

If you see an error in `<SiteScope>\logs\bac_integration\discovery.log`, clear the topology cache on SiteScope:

- Set the SiteScope service.
- Delete the 4 files in `<SiteScope>\discovery\hsqldb` directory
- Start the SiteScope service.
- Re-synchronize the topology. Log in to SiteScope and navigate to **Preferences > Integration Preferences**. Edit **BSM Integration**, and in the resulting window click **Re-Synchronize** under **BSM Preferences Available Operations**.

How to Drill Down to SiteScope

When SiteScope monitors are used to set the status of a configuration item (CI), you can drill down from the CI (or from a health indicator (HI) on the CI) to a SiteScope monitor that contributes to the HI's status.

1. Access menu commands from a CI or HI in a My Workspace page or component, for example 360° View, Top View, View Explorer, Health Indicator, or the SiteScope Multi-View component. Select **Go to >SiteScope**. The SiteScope UI opens directly to the parent group of the relevant monitor.

If monitors from multiple groups contribute to the CI's or HI's status, the **Drilldown to SiteScope** dialog box opens. Select the monitor to which you want to drill down and open it in SiteScope.

The Drilldown to SiteScope dialog box displays the following hierarchy:

- The root level shows health indicators.
If you open the dialog box for a CI, one or more HIs that contribute to the CIs status are listed. If you open the dialog box for an HI, this HI appears as the root.
- The level below the root shows the SiteScope systems (connected server name) that have monitors contributing to the HI.
- The lowest level shows the SiteScope monitors that contribute to the HI.

Note: In the **System Monitors** view, if you select **Go to > SiteScope** from a monitored CI, SiteScope opens the monitor's parent group. If you select this from a group CI, SiteScope opens directly to the group.

2. Select a SiteScope monitor, and click **Drilldown**.

For details on working with SiteScope, see SiteScope Help.

How to Connect to a SiteScope Server That Requires TLS

To connect to a SiteScope server that requires TLS, OMi must trust the root certificate that was used to sign the SiteScope certificate. This is done by adding the root certificate to the CA keystore of the OMi server and to the CA keystore of the SiteScope server.

Caution: Clients can no longer connect to SiteScope 11.33 (and later versions) by using an HTTPS URL starting with `https://localhost`. Instead, the host name of the SiteScope system must be used. You can set the host name in SiteScope by running the following command:

```
$ ovconfchg -ns opr.sisconfig -set sis_host <SiS_hostname>
```

Complete one of the following procedures depending on the type of certificate that was used to sign the SiteScope certificate:

Note: If the OMi server runs a Linux operating system, replace the paths in the following procedures with their Linux equivalents.

- **Certificate from a certificate authority.** If the SiteScope certificate was signed with a certificate from a certificate authority, import the certificate to the SiteScope CA keystore and to the CA keystore of the OMi server:
 - a. Obtain the root certificate (and any other intermediate certificate) from the certificate authority.
 - b. On the SiteScope server to which you want to deploy policies, import the root certificate (and any other intermediate certificate) to the SiteScope CA keystore. Type:

```
C:\SiteScope\java\bin\keytool -importcert -alias <yourCA> -file
<CAcertificateFile> -keystore C:\SiteScope\java\lib\security\cacerts
```

When prompted for the password, type the keystore password. (The default password is changeit.)

- c. On the OMi server to which you want to export SiteScope templates, import the root certificate (and any other intermediate certificate) to the OMi CA keystore. Type:

```
<OMi_HOME>\bin\opr-cert-mgmt.[bat|sh] -import <alias> <path>
```

When prompted for the password, type the keystore password. (The default password is changeit.)

- d. Restart SiteScope, so that the newly imported certificate will be recognized and used by the integration.
- **SiteScope self-signed certificate.** If the SiteScope certificate is a self-signed certificate (for example, a certificate that was created and configured with the SiteScope tool **ssl_util**), export the self-signed certificate from SiteScope and import it to the CA keystores of the OMi server and SiteScope:

- a. On the SiteScope server, export the self-signed certificate, type:

```
C:\SiteScope\java\bin\keytool -exportcert -keystore
C:\SiteScope\groups\serverkeystore -alias sitescope -file <certificateFile>
```

When prompted for the keystore password, type the password that was specified when using the **ssl_util** tool.

- b. On the SiteScope server, import the self-signed certificate to the SiteScope CA keystore. Type:

```
C:\SiteScope\java\bin\keytool -importcert -file <certificateFile> -keystore
C:\SiteScope\java\lib\security\cacerts
```

When prompted for the password, type the keystore password. (The default password is changeit.)

- c. Copy the certificate to the OMi server to which you want to export SiteScope templates.
- d. On the OMi server, import the self-signed certificate to the OMi CA keystore. Type:

```
<OMi_HOME>\bin\opr-cert-mgmt.[bat|sh] -import <alias> <path>
```

Note: For more information on the `opr-cert-mgmt` tool, see *the OMi Extensibility Guide*.

When prompted for the password, type the keystore password (the default password is `changeit`).

- e. Restart SiteScope, so that the newly imported certificate will be recognized and used by the integration.
- f. *Required if both OMi and SiteScope use HTTPS setup.* Import the SiteScope server Keystore to the OMi CA keystore:
 - i. Copy the SiteScope serverKeystore, located in `C:\SiteScope\groups\serverKeystore`, to the following location in OMi: `<OMi_HOME>\JRE\lib\security`
 - ii. Import the serverKeystore to OMi cacerts:

```
<OMi_HOME>\JRE\bin\keytool -importkeystore -destkeystore cacerts -
deststorepass <keypass> -srckeystore \tmp\serverKeystore -srcstorepass
<keypass>
```

For `<keypass>`, define the keystore password that you set in SiteScope.
 - iii. Restart SiteScope and the OMi gateway server.

Setting up TLS between sisconfig and SiteScope runtime

The sisconfig component is the adapter between the Operations Agent and the SiteScope runtime. If you are performing the integration to enable configuration and deployment of SiS monitors from OMi, and you want TLS to be enabled, follow these steps:

1. Set up TLS for SiteScope:
 - a. If SiteScope was not yet configured to run with HTTPS, set up a self-signed certificate:

```
<SiteScopeDir>/java/bin/keytool -genkey -dname "CN=www.example.net,
OU=myOffice, O=myCompany, L=myLocation, ST=myState, C=myCountry" -alias
myAlias -keypass mykeypass -keystore

<SiteScopeDir>/groups/serverKeystore -storepass mykeypass -kealg "RSA" -
validity 742
```
 - b. Modify tomcat:

In `<SiteScopeDir>/Tomcat/conf/server.xml` comment the `port="8080"` and add the following:

```
<Connector port="8443" maxThreads="150" minSpareThreads="25"
maxSpareThreads="75" enableLookups="false" disableUploadTimeout="true"
acceptCount="100" debug="0" scheme="https" secure="true" clientAuth="false"
sslProtocol="TLS" keystoreFile="<SiteScopeDir>/groups/serverKeystore"
keystorePass="passphrase" />
```

Restart tomcat.

2. Set up TLS for sisconfig:

- a. Import the SiteScope root certificate to the Java keystore so that sisconfig can find it:

```
<SiteScopeDir>\java\bin\keytool -import -keystore
SiteScopeDir>\java\lib\security\cacerts -storepass mykeypass -trustcacerts -
file "<SiteScopeDir>\groups\serverKeystore"
```

- b. Set https_enabled=true and check that the port is 8443:

```
<OvBinDir>\ovconfchg -ns opr.sisconfig -set https_enabled true
<OvBinDir>\ovconfchg -ns opr.sisconfig -set sis_port 8443
```

- c. Restart sisconfig:

```
<OvBinDir>\ovc -restart sisconfig
```

Part IV: Operations Manager i - HPE Operations Manager Integration

Chapter 9: Operations Manager i - HP

Operations Manager Integration Overview

HP Operations Manager (OM) can be integrated into your OMi environment to become a data source for OMi. OM for Windows, OM for UNIX (UX and Solaris), and OM for Linux are supported.

After you install both OMi and OM, follow the described procedures to connect OMi and OM. This connection enables bidirectional synchronization of events between the two systems, tool execution, and instruction text retrieval. The connection configuration requires you to establish a trust relationship between the OMi and OM systems, as well as to configure a message forwarding policy.

The integration between OMi and OM provides you with the following capabilities:

- **OM events > OMi.** Events from OM are displayed in the OMi Event Browser.
- **OM events > OMi health indicators.** After you set up the integration, if the OM events have corresponding health indicators defined, these health indicators automatically affect the status of the relevant Configuration Items (CIs) in OMi applications such as Service Health. For an introduction to health indicators, see the *OMi User Guide*.
- **OMi Actions, Tools, and Instructions.** You can specify tools, for example, to ping a system. These tools are launched from events or the Actions panel and run on the associated CI. The tools are designed to help users solve common problems quickly and efficiently. All available tools are launched in the context of a CI. The selection of tools a particular user sees in context menus depends on the tools that are available for the CI affected by a particular event.

Events received in the OMi Event Browser may contain event-related actions configured in OM. If event-related actions exist, you can run these actions from the OMi console. OM actions can be either operator-initiated, or can run automatically when an event occurs. For a complete overview of available actions and how to run them, see OMi Help.

Operators working with the OM message browser can see additional instructions for the selected message. It is equally helpful for OMi operators to be able to access this information when using OM servers to forward events to OMi. This information is displayed in the Instructions tab of the Event Browser. For details, see the *OMi User Guide*.

- **OM topology > RTSM topology.** The OM topology can synchronize with the OMi RTSM topology. Using topology synchronization, the OM services are synchronized with OMi, and by using corresponding mapping rules, they are transformed into CIs stored in the RTSM. For details, see the *OMi Administration Guide*.

Note: If the OM topology is not synchronized with the RTSM topology by using the OMi topology synchronization mechanism, the **Monitored by** property of the OMi CIs corresponding to the OM services may be empty. As a consequence, these CIs are not displayed in the System Monitors only Perspective, System Hardware Monitoring, and System Software Monitoring views.

Chapter 10: Workflow: Configuring Connections Between Operations Manager i and OM

1. Establish a trust relationship between OMi and OM

For connection and communication between OMi and OM hosts, establish a trust relationship between all the servers.

For task details, see ["Establishing a trust relationship for a server connection" on page 62](#).

To verify the trusted relationship, see ["Verifying the trusted relationship" on page 65](#).

2. Set up the OM server as a connected server

Set up the OM server as a connected server so that you can run actions and tools from OMi, and retrieve instructions from the OM server.

For task details, see ["How to Create a Connection to an OM Server" on page 66](#).

3. Synchronize the topology

To populate the OMi database (RTSM) with the configuration item (topology) and service data from OM, you must synchronize the topology. Topology synchronization is configured to update all specified servers with the topology and service data from the OM server.

For task details, see ["How to Run Topology Synchronization" on page 70](#).

4. Configure the OM forwarding policy

To enable event synchronization between OM and OMi, set up a message forwarding policy on the OM server. The policy includes the node name of the target OMi server. Alternatively, specify the load balancers, if configured, or one Gateway Server for each OMi installation, as appropriate for your high-availability arrangement.

- **OM for Windows.** For task details, see ["How to Configure the OM for Windows Forwarding Policy" on page 76](#).
- **OM for UNIX or Linux.** For task details, see ["How to Configure the OM for UNIX or Linux Forwarding Policy" on page 79](#).

5. Validate event synchronization

Validate event synchronization and test the connection between OM and OMi.

For task details, see ["How to Validate Event Synchronization" on page 83](#).

Chapter 11: Establishing a trust relationship for a server connection

For connection and communication between OMi and OM hosts or other OMi hosts, you must establish a trust relationship between the systems.

In OM server pooling, the virtual server must have a certificate that is trusted by all OM hosts in the server pool and by all OMi hosts.

Note: The trust relationship must be set up on all nodes (data processing servers, gateway servers, manager-of-manager configurations, load balancers, and reverse proxies). However, some load balancer technologies include a by-pass or pass-through functionality for incoming encrypted messages to its pool members. When using such technologies, the trust relationship on the load balancer node is not required if you are load balancing on the recommended OSI layer 2 or 4.

How to establish a trust relationship between the data processing servers and external server systems)

1. On the OMi data processing server, execute the following command:

```
BBCTrustServer[.bat|sh] <external_server>
```

Replace <external_server> with the FQDN of the external system (for example, ommgmtsv).

Note: The value of <external_server> should be the virtual name if the OM server is part of a server pool or runs in a high-availability (HA) cluster.

When asked if to add a certificate to the trust store, enter **y**.

If the trusted certificate already exists, the tool asks you if you want to overwrite the existing certificate. To replace the existing certificate with a new one, enter **y**.

2. *OM servers only:*

Note: If you have the appropriate OM patch or version, you can skip this step.

- OM for Windows: Starting with patches OMW_00121 (32-bit) and OMW_00122 (64-bit), the BBCTrustServer tool is already installed in the %OvInstallDir%\contrib\OVOW

folder.

- OM for UNIX or Linux: Starting with OM server version 9.10.220, the BBCTrustServer tool is already installed in the `/opt/OV/bin` directory.

- a. Locate the following files on the OMi data processing server:

```
<OMi_HOME>/opr/lib/cli/opr-cli.jar
```

```
<OMi_HOME>/opr/bin/BBCTrustServer.bat
```

```
<OMi_HOME>/opr/bin/BBCTrustServer.sh
```

- b. *OM for Windows only:* Copy the files to the machine that is running the OM for Windows management server.

```
Copy opr-cli.jar to %OvInstallDir%\java\opr-cli.jar.
```

```
Copy BBCTrustServer.bat to %OvBinDir%\BBCTrustServer.bat.
```

- c. *OM for UNIX and Linux only:* Copy the files to the machine that is running the OM for UNIX or Linux management server.

```
Copy opr-cli.jar to /opt/OV/java/opr-cli.jar.
```

```
Copy BBCTrustServer.sh to /opt/OV/bin/BBCTrustServer.sh.
```

Change the permissions of the BBCTrustServer tool by entering the following command:

```
chmod 555 /opt/OV/bin/BBCTrustServer.sh
```

3. If you do not have a load balancer or a reverse proxy, or your load balancer is configured to work on **OSI layers 2 or 4** (recommended by HPE), execute the following command on the external system:

```
BBCTrustServer.[bat|sh] <Load_balancer_or_single_gateway_server_or_RP_or_Server_Pool_Virtual_Interface>
```

When asked if to add a certificate to the trust store, enter **y**.

If the trusted certificate already exists, the tool asks you if you want to overwrite the existing certificate. To replace the existing certificate with a new one, enter **y**.

4. If you are using a reverse proxy or your load balancer is configured to work on **OSI layer 7**, you must exchange the certificates manually:

- a. On the OMi data processing server, execute the following command:

```
ovcert -exporttrusted -file <omi.cer>
```

- b. On the external system, execute the following command:

```
ovcert -exporttrusted -file <other.cer>
```

- c. Copy <other.cer> from the external system to the OMi data processing server.
- d. Copy <omi.cer> from the OMi data processing server to the external system.
- e. On the OMi data processing server, execute the following commands:

```
ovcert -importtrusted -file <other.cer>
```

```
ovcert -importtrusted -file <other.cer> -ovrg server
```

- f. On the external system, execute the following commands:

```
ovcert -importtrusted -file <omi.cer>
```

```
ovcert -importtrusted -file <omi.cer> -ovrg server
```

5. If you are using a load balancer or a reverse proxy, where your data sources are not communicating directly with the OMi gateway servers, make sure that port 383 is routed through the load balancer to the OMi gateway servers.

If the load balancer or the reverse proxy is configured to pass through traffic directly (**OSI layers 2 or 4**), skip to the next step. If configured to work on **OSI layer 7**, perform as follows:

- o The certificate on the load balancer must be installed for port 383 (or the port that you configured for secure communication).
 - o Communication between the load balancer and the gateway server systems must be secured.
 - o The load balancer must possess a server certificate for authentication so that the external systems can connect successfully. The load balancer must also validate client certificates presented by external clients (for example, OM servers).
 - o The load balancer must possess a client certificate for authentication with OMi.
- a. Issue a certificate for the load balancer from the OMi data processing server:

```
ovcm -issue -file <certificate file> -name <Fully Qualified Domain Name of Virtual Interface or Reverse Proxy> [ -pass <passphrase>]
```

- b. Import this certificate as a server and client certificate into your load balancer.

For details on the required format, see your load balancer documentation. You can use `openssl` to convert the certificates into the required format.

6. Check the connection between the servers. For details, see ["Verifying the trusted relationship" on page 65](#).

Chapter 12: Verifying the trusted relationship

After establishing a trust relationship between the OMi Data Processing Server and external systems, check the connection between the two systems. You can do this while setting up your connected server by clicking  **Run Test** or by using the command line interface.

How to check the connection between the OMi server environment and an external system by using the command line interface

1. From the external host, verify that communication to the OMi installation is possible (the return value should be eServiceOk) by executing the following command on the external server system:

```
bbcutil -ping https://<Load_balancer_or_single_gateway_server_or_RP_or_Server_Pool_Virtual_Interface>
```

Example of the command result:

```
https://<HPE OMi servername>: status=eServiceOK  
coreID=7c66bf42-d06b-752e-0e93-e82d1644cef8 bbcV=06.10.105  
appN=ovbbccb appV=11.03.031 conn=1 time=1094 ms
```

2. From all OMi Gateway Server hosts, verify that communication with the external server host is possible (the return value should be eServiceOk) by executing the following command:

```
bbcutil -ping https://<external_server_hostname>
```

Example of the command result:

```
https://<external_host_server_name>: status=eServiceOK  
coreID=0c43c032-5c94-7535-064a-f7654a86f2d3 bbcV=06.10.070  
appN=ovbbccb appV=11.03.031 conn=7 time=140 ms
```

Troubleshooting

If the `bbcutil -ping` command executes but does not return eServiceOk, you may need to restart the ovc processes on the system that is not responding by running the following commands:

- Linux: `/opt/OV/bin/ovc -kill` and `/opt/OV/bin/ovc -start`
- Windows: `ovc -kill` and `ovc -start`

Chapter 13: How to Create a Connection to an OM Server

OMi can forward events, run actions and tools on the OM server, and retrieve instructions from the OM server. Credentials for the OM web service are required for this processing.

1. In the central Connected Servers pane, click ✱ **New** and select **Operations Manager for UNIX** or **Operations Manager for Windows**. Alternatively, you can click ✱ **New** in the Operations Manager for UNIX or Operations Manager for Windows area in the right pane.

The Create Operations Manager for UNIX Server or Create Operations Manager for Windows Server panel opens.

2. In the General section, enter a display label, an identifier (a unique internal name if you want to replace the automatically generated one), and, optionally, a description of the connection being specified.
3. In the Server Properties section, complete the following information:
 - a. Enter the fully qualified domain name of the host system of the OM server.

Note: If the host system is a high-availability cluster, enter the fully qualified domain name of the cluster package where the OM server is installed. If OM is installed in a server pooling environment, add the virtual interface as the first OM server. Add all physical pool servers separately as connected servers.

- b. Enter the name of the integration user that is used to log in to the OM server.

For OM for Windows servers, specify both the domain to which the host system belongs and the user name: `<DOMAIN>\<user name>`. If the host system is not part of a domain, replace `<DOMAIN>` with the host name of the system.

HPE recommends to use a dedicated user so that it is clear which events are owned by and being worked on in OMi.

Note: All messages forwarded from OM systems are treated as allowing read and write. Any changes made to these events result in back synchronization to the originating OM server.

- For OM for Windows, the selected user must have at least PowerUser rights and must be a member of the HP-OVE-Admins group and the local administrators group

(for example, HP-OVE-User).

- For OM for UNIX or Linux, *only* the Integration User (opc_adm) has the necessary OM administrator rights to be able to synchronize topology and execute tools.
- c. Select the **Enable sending event updates to the Operations Manager for UNIX server** or **Enable sending event updates to the Operations Manager for Windows server** check box if you want to forward events and synchronize event updates from this OMi server back to the Operations Manager server.
- d. *Optional.* Customize the way events and change notifications are delivered to this server by using Advanced Delivery Options:
- **Serial:** Events and change notifications are delivered serially in the order in which they were received.
 - **Serial per source:** *Default.* Each originating server is provided with a dedicated outgoing request delivery path. For each individual outgoing request delivery path, events and change notifications are delivered serially in the order in which they were received. This can increase the throughput for delivery of events and change notifications when many events are received from multiple originating servers, while maintaining the incoming order.
 - **Parallel:** The configured number of outgoing request delivery paths is used when forwarding events and change notifications. This can further increase the throughput for delivery of events and change notifications. However, because the source of the event is not considered, maintenance of the incoming order cannot be guaranteed.
- e. Select the **Forward dynamic topology** check box if you want to forward dynamic topology information from the OMi instance to which you are logged in, to the OM instance that you are currently configuring.

Note: If you change the status of the Forward dynamic topology check box, you must restart the WDE process on all gateway servers. To do so, run the following commands:

```
<OMi_HOME>/opr/support/opr-support-utils.[bat|sh] -stop wde
```

```
<OMi_HOME>/opr/support/opr-support-utils.[bat|sh] -start wde
```

Important: In most cases, you should leave the **Forward dynamic topology** check box clear. Otherwise, OMi will resend the topology data received from one OM server to the rest of OM servers. This may lead to unexpected consequences on OM servers (for example, a deleted node on an OM server may reappear after some time, or new nodes may appear on an OM server after you add a node by using a data collector, such as

SiteScope).

4. In the Outgoing Connection section, complete the following information:

Note: If you are editing outgoing connection properties, you must restart the **MercuryAS** process for the changes to take effect.

- Select **Use this server** if you are using this server for receiving instructions, and executing tools and actions on external nodes, and then follow these steps:
 - i. Enter the password for the integration user.
 - ii. Enter the port required to access the server for receiving instructions, and executing tools and actions. The default port value is automatically inserted and can be restored by clicking **Set default port**.
 - iii. *Optional.* If you are using secure communication (default), make sure that the **Use secure HTTP** check box is selected, and then apply a certificate by clicking **import the certificate** and using one of the following methods:
 - **Connect and Import from Server:** Retrieves a certificate from the host system specified in this server connection.
 - **Import from File:** Opens the file browser and enables you to navigate to and specify a Base64 Encoded X.509 certificate file for the server connection.
- Select **Use other server** if you are using an alternative server for providing instructions, and executing actions and tools, and then select a server from the list. For the physical servers in a server pooling environment, select the virtual interface connected server.

Note: In a clustered OM for Windows environment, the IIS web server on all cluster nodes must have the same certificate. If different, valid certificates are used, problems such as tools execution may be experienced after switching to a node with a different certificate. For more details, see the article available at <https://softwaresupport.hpe.com/km/KM01211399>.

Note: Secure communication is necessary for OM server pooling environments. However, do not use the **Connect and Import from Server** or **Import from File** option.

Set up a trusted relationship between all OM and OMi servers as described in ["Establishing a trust relationship for a server connection" on page 62](#).

Note: Avoid selecting an alternative action execution server that creates a loop and

results in specifying the connected server as the action execution server. Select an alternative action execution server or use the **Use this server** option.

5. In the Test Connections section, click  **Run Test** to check that the specified connection attributes are correct. If an error message is displayed, correct the connection information, and retest the connection.
6. Make sure that the **Activate after save** check box is selected if you want to enable the server connection immediately.
7. Click **Create**.

Chapter 14: How to Run Topology Synchronization

Before configuring the forwarding of topology (node and service) data to OMi from OM servers, complete the following configuration steps in OMi:

- Establish a trust relationship between the Data Processing Server and the OM server. For details, see ["Establishing a trust relationship for a server connection" on page 62](#).
- Add the OM server as a connected server to OMi. For details, see ["How to Create a Connection to an OM Server" on page 66](#).
- *Optional.* Import content packs. For details, see the *OMi Administration Guide*.
- *Optional.* Use the `opr-sdtool. [bat | sh]` command line tool to upload new or changed synchronization packages from the file system to the database. For details, see the *OMi Extensibility Guide*.

Note: You can also use the Content Manager to import and export the existing synchronization packages in the Content Manager format.

After ensuring that the OM server is added to OMi as a connected server, configure the forwarding of topology (node and service) data on the OM server.

The following sections describe how to configure topology synchronization:

- ["How to Configure Topology Synchronization on OM for Windows Systems" below](#)
- ["How to Migrate from Scheduled Synchronization on OM for Windows Systems" on the next page](#)
- ["How to Configure Topology Synchronization on OM for UNIX or Linux Systems" on page 73](#)
- ["How to Migrate from Scheduled Synchronization on OM for UNIX or Linux Systems" on page 74](#)

How to Configure Topology Synchronization on OM for Windows Systems

This section describes how to configure topology synchronization on OM for Windows management servers. For further details, see the OM for Windows documentation.

To forward topology data to OMi, complete the following steps on the OM for Windows management server from which you want to receive topology information:

1. *Prerequisite.* Make sure that the minimum patch level for the OM for Windows management server is installed:
 - Version 8.16: Patch OMW_00121 or superseding patch
 - Version 9.00: Patch OMW_00122 or superseding patch
2. *Prerequisite.* Configure trusted certificates for multiple servers.

In an environment with multiple servers, you must configure each server to trust certificates that the other servers issued.

3. In the console tree, right-click **Operations Manager**, and then click **Configure > Server....** The Server Configuration dialog box opens.
4. Click **Namespaces**, and then click **Discovery Server**. A list of values appears.
5. Add the hostname of the server to **List of target servers to forward discovery data**. If there is more than one target server, separate the hostnames with semicolons, for example:

```
server1.example.com;server2.example.com
```

If the target server uses a port other than port 383, append the port number to the hostname, for example:

```
server1.example.com:65530;server2.example.com:65531
```

6. Make sure that the value of **Enable discovery WMI listener** is true. This is the default value.
7. Click **OK** to save your changes and close the Server Configuration dialog box.
8. Restart the `OvAutoDiscovery Server` service for your changes to take effect:

```
net stop "OvAutoDiscovery Server"
net start "OvAutoDiscovery Server"
```

9. Start the initial synchronization of topology data:
 - a. In the console tree, select **Tools > HP Operations Manager Tools**.
 - b. Right-click **Synchronize Topology** and select **All Tasks > Launch Tool....**

The `startInitialSync.bat` tool is started and begins to send all the topology data to the configured target management servers.

How to Migrate from Scheduled Synchronization on OM for Windows Systems

This section describes how to migrate from scheduled synchronization on OM for Windows

management servers. For further details, see the OM for Windows documentation.

To migrate from scheduled synchronization, complete the following steps on the OM for Windows management server from which you want to receive topology information:

1. *Prerequisite.* Make sure that the minimum patch level for the OM for Windows management server is installed:

- Version 8.16: Patch OMW_00121 or superseding patch
- Version 9.00: Patch OMW_00122 or superseding patch

2. Clear the agent repository cache on the OM management server by using the following command:

```
%OvBinDir%\ovagtrep -clearall
```

3. Remove the service auto-discovery policies from the OM management server node:

```
%OvBinDir%\ovpolicy -remove DiscoverOM
```

```
%OvBinDir%\ovpolicy -remove DiscoverOMTypes
```

4. Synchronize the policy inventory on the OM management server:

- a. In the console tree, right-click the management server.
- b. Select **All Tasks > Synchronize inventory > Policies**.

The management server creates a deployment job to retrieve the inventory from the local agent.

5. Make sure the listener process is running:

- a. In the console tree, right-click **Operations Manager**, and select **Configure Server**.

The Server Configuration dialog box opens.

- b. Click **Namespaces**, and select **Discovery Server**.

A list of values appears.

- c. Set the value of **Enable discovery WMI listener** to true. This is the default value.

- d. Click **OK** to save your changes and close the Server Configuration dialog box.

- e. Restart the `OvAutoDiscovery Server` service for your changes to take effect:

```
net stop "OvAutoDiscovery Server"
```

```
net start "OvAutoDiscovery Server"
```

6. Start the initial synchronization of topology data:

- a. In the console tree, select **Tools > HP Operations Manager Tools**.
- b. Right-click **Synchronize Topology** and select **All Tasks > Launch Tool...**

The `startInitialSync.bat` tool is started and begins to send all the topology data to the configured target servers.

How to Configure Topology Synchronization on OM for UNIX or Linux Systems

This section describes how to configure topology synchronization on OM for UNIX or Linux management servers. For further details, see the OM for UNIX or Linux documentation.

To forward topology data to OMi, complete the following steps on the OM for UNIX or Linux management server from which you want to receive topology information:

1. *Prerequisite.* Make sure that the minimum patch level for the OM 9.10 for UNIX or Linux management server is installed:

- HP-UX: Patch PHSS_42736 or superseding patch
- Linux: Patch OML_00050 or superseding patch
- Solaris: Patch ITOSOL_00772 or superseding patch

2. *Prerequisite.* Configure trusted certificates for multiple servers.

In an environment with multiple servers, you must configure each server to trust certificates that the other servers issued.

3. *Prerequisite.* Set up the forwarding target (OMi Gateway Server, Reverse Proxy, or Load Balancer) in the node bank as a managed node. To do so, run the following command:

```
/opt/OV/bin/OpC/utils/opcnode -add_node node_name=<node_name> net_type=NETWORK_IP mach_type=<machine_type> group_name=<group_name> node_label=<node_name>
```

In this instance, `<machine_type>` relates to the operating system of the OMi host system, `MACH_BBC_WIN2K3_X64` (Windows) or `MACH_BBC_LX26RPM_X64` (Linux), whereas `<group_name>` relates to the operating system of the OM server host system, `hp_ux`, `solaris`, or `linux`.

4. Type the following command to enable topology synchronization:

```
/opt/OV/contrib/OpC/enableToposync.sh -online -target <comma_separated_server_list>
```

Replace `<comma_separated_server_list>` with the fully qualified domain name of the target management server. If you have more than one target management server, separate each server name with a comma (,). Do not include spaces in the server list.

This command restarts the service discovery server. The source management server begins to send any topology data changes immediately.

5. Type the following command to start the initial synchronization of topology data:

```
/opt/OV/bin/OpC/startInitialSync.sh
```

How to Migrate from Scheduled Synchronization on OM for UNIX or Linux Systems

This section describes how to migrate from scheduled synchronization on OM for UNIX or Linux management servers. For further details, see the OM for UNIX or Linux documentation.

To migrate from scheduled synchronization, complete the following steps on the OM for UNIX or Linux management server from which you want to receive topology information:

1. *Prerequisite.* Make sure that the minimum patch level for the OM 9.10 for UNIX or Linux management server is installed:

- HP-UX: Patch PHSS_42736 or superseding patch
- Linux: Patch OML_00050 or superseding patch
- Solaris: Patch ITOSOL_00772 or superseding patch

2. Clear the agent repository cache on the management server by using the following command:

```
/opt/OV/bin/ovagtrep -clearall
```

3. Remove the service auto-discovery policies from the management server node:

```
/opt/OV/bin/ovpolicy -remove DiscoverOM
```

```
/opt/OV/bin/ovpolicy -remove DiscoverOMTypes
```

4. Deassign the service auto-discovery policies from the management server node:

```
/opt/OV/bin/OpC/utills/opcnode -deassign_pol node_name=<management_server> net_
type=NETWORK_IP pol_name=DiscoverOMTypes pol_type=svcdisc
```

```
/opt/OV/bin/OpC/utills/opcnode -deassign_pol node_name=<management_server> net_
type=NETWORK_IP pol_name=DiscoverOM pol_type=svcdisc
```

```
/opt/OV/bin/OpC/opcragt -dist <management_server>
```

Replace <management_server> with the name of the management server.

5. Type the following command to enable topology synchronization:

```
/opt/OV/contrib/OpC/enableToposync.sh -online
```

This command restarts the service discovery server. The source management server begins to send any topology data changes immediately.

6. Type the following command to start the initial synchronization of topology data:

```
/opt/OV/bin/OpC/startInitialSync.sh
```

Chapter 15: How to Configure the OM for Windows Forwarding Policy

To enable event synchronization between OM and OMi, set up a message forwarding policy on the OM server. The policy includes the node name of the target OMi server. Alternatively, specify the load balancers, if configured, or one Gateway Server for each OMi installation, as appropriate for your high-availability arrangement.

Before setting up a policy and to avoid overwriting the current settings, verify if a policy of the type **Server-based Flexible Management** is already active on the OM for Windows server. If a policy does not exist, create a new policy as described in ["Create a New Policy"](#) below. If a policy already exists and is active, adapt the policy as described in ["Adapt an Active Policy"](#) on the next page.

Create a New Policy

To set up a new policy on OM for Windows, complete the following steps:

1. Start the OM for Windows console as follows:
Start > Programs > HP > HP Operations Manager
2. In the left pane of the OM for Windows console, select the following:
Policy management > Policies grouped by type > Server Policies > Server-based Flexible Management
3. Verify that no Server-based Flexible Management policy exists. If such a policy does exist, go to ["Adapt an Active Policy"](#) on the next page.
4. Right-click **Server-based Flexible Management** (or a blank space in the right pane), and then select **New > Policy**.

The Server-based Flexible Management Editor dialog box opens.

5. In the **General** tab text pane, insert the following policy text:

```
TIMETEMPLATES
# none
RESPMGRCONFIGS
    RESPMGRCONFIG DESCRIPTION "Forward all messages to OMi"
    SECONDARYMANAGERS
    ACTIONALLOWMANAGERS
    MSGTARGETRULES
```

```
MSGTARGETRULE DESCRIPTION "Forward all messages rule"
MSGTARGETRULECONDS
MSGTARGETRULECOND DESCRIPTION "Forward all messages"
MSGTARGETMANAGERS
MSGTARGETMANAGER
TIMETEMPLATE "$OPC_ALWAYS"
OPCMGR IP 0.0.0.0 "<OMi fully qualified host name>"
```

Note: This forwards all messages to OMi. If you want to reduce the number of messages to be sent, modify the text of the policy so that only a selected subset of messages is sent to OMi. For details, see the OM documentation.

6. Replace `<OMi fully qualified host name>` in the policy text with the fully qualified hostname of the Gateway server to receive OM messages (for example, `HPEGwSrv.example.com`).

In deployments involving a load balancer, a NAT device, or a reverse proxy, use the fully qualified hostname of the system used to access the Gateway server (for example, `VirtualSrv.example.com`).

7. Click **Check Syntax** to check for syntax errors in the new policy text.
8. After correcting any syntax errors, click **Save and Close**.
9. In the Save As dialog box that opens, enter a name and a description for the new policy.
10. Click **OK** to close the Save As dialog box.
11. From the Policy Management folder, right-click the policy, and the select **All Tasks > Deploy on**.
12. In the Deploy server policy on dialog box that opens, select the name of your OM management server.
13. Click **OK** to deploy the server-based flexible management policy on the OM for Windows management server.

Adapt an Active Policy

If a message forwarding policy already exists on the OM for Windows system, complete the following steps to edit this policy and add another message target manager to it:

1. Start the OM for Windows console as follows:
 - Start > Programs > HP > HP Operations Manager**
2. In the left pane of the OM for Windows console, select the following:

Policy management > Server policies grouped by type > Server-based Flexible Management

3. In the right pane of the OM for Windows console, double-click the existing policy that you want to edit. The Server-based Flexible Management Editor dialog opens.

If such a policy does not exist, go to ["Create a New Policy" on page 76](#).

4. Add another message target manager as shown in the following example policy text:

```
TIMEMPLATES
# none
RESPMGRCONFIGS
  RESPMGRCONFIG DESCRIPTION "Forward all messages to OMi"
SECONDARYMANAGERS
ACTIONALLOWMANAGERS
MSGTARGETRULES
  MSGTARGETRULE DESCRIPTION "Forward all messages rule"
  MSGTARGETRULECONDS
  MSGTARGETRULECOND DESCRIPTION "Forward all messages"
  MSGTARGETMANAGERS
    MSGTARGETMANAGER
    TIMEMPLATE "$OPC_ALWAYS"
    OPCMGR IP 0.0.0.0 "<First Target Manager>"

    MSGTARGETMANAGER
    TIMEMPLATE "$OPC_ALWAYS"
    OPCMGR IP 0.0.0.0 "<OMi fully qualified host name>"
```

Note: This forwards all messages to OMi. If you want to reduce the number of messages to be sent, modify the text of the policy so that only a selected subset of messages is sent to OMi. For details, see the OM documentation.

5. Replace `<OMi fully qualified host name>` in the text with the fully qualified hostname of the Gateway server that should receive OM messages (for example, `HPEGwSrv.example.com`).

In deployments involving a load balancer, a NAT device, or a reverse proxy, use the fully qualified hostname of the system used to access the Gateway server (for example, `VirtualSrv.example.com`).

6. Click **Check Syntax** to check for syntax errors in the new policy text.
7. After correcting any syntax errors, click **Save and Close**.
8. Redeploy the server-based flexible management policy on the OM for Windows management server.

Chapter 16: How to Configure the OM for UNIX or Linux Forwarding Policy

To enable event synchronization between OM and OMi, you must set up a message forwarding policy on each OM management server with the node name of the load balancer, if configured, or one Gateway Server, as appropriate for your high-availability arrangement.

Before setting up a policy, make sure that the forwarding target is set up as a node (see "[Set up a Forwarding Target in the OM for UNIX or Linux Node Bank](#)" below). In addition, verify if the **msgforw** policy is already active on the OM for UNIX or Linux server. If the **msgforw** does not exist, create a new policy as described in "[Create a New Policy](#)" below. If the **msgforw** policy already exists and is active, adapt the policy as described in "[Adapt an Active Policy](#)" on page 81.

Set up a Forwarding Target in the OM for UNIX or Linux Node Bank

Note: Make sure that the SNMP agent is running before adding a managed node to the OM database.

The forwarding target (OMi Gateway Server, Reverse Proxy, or Load Balancer) must be set up in the node bank as a managed node. You must add the managed node by using the `opcnode` command line tool:

```
/opt/OV/bin/OpC/Utils/opcnode -add_node node_name=<node_name> net_type=NETWORK_IP  
mach_type=<machine_type> group_name=<group_name> node_label=<node_name>
```

In this instance, `<machine_type>` relates to the operating system of the OMi host system, `MACH_BBC_WIN2K3_X64` (Windows) or `MACH_BBC_LX26RPM_X64` (Linux), whereas `<group_name>` relates to the operating system of the OM server host system, `hp_ux`, `solaris`, or `linux`.

To verify that the node was added successfully, run the following command:

```
/opt/OV/bin/OpC/Utils/opcnode -list_nodes
```

Create a New Policy

To set up a new message forwarding policy on OM for UNIX or Linux, complete the following steps:

1. Change to the `work_respmgrs` directory as follows:

```
cd /etc/opt/OV/share/conf/OpC/mgmt_sv/work_respmgrs/
```

Note: Policy template files can be found in `/etc/opt/OV/share/conf/OpC/mgmt_sv/tmpl_respmgrs`.

2. Create a new policy file by using the following command:

```
vi <policy file name>
```

3. Insert the following text into the new policy file:

```
TIMETEMPLATES
# none
RESPMGRCONFIGS
  RESPMGRCONFIG DESCRIPTION "Forward all messages to OMi"
  SECONDARYMANAGERS
  ACTIONALLOWMANAGERS
  MSGTARGETRULES
    MSGTARGETRULE DESCRIPTION "Forward all messages rule"
    MSGTARGETRULECONDS
    MSGTARGETRULECOND DESCRIPTION "Forward all messages"
    MSGTARGETMANAGERS
      MSGTARGETMANAGER
      TIMETEMPLATE "$OPC_ALWAYS"
      OPCMGR IP 0.0.0.0 "<OMi fully qualified host name>"
```

Note: This forwards all messages to OMi. If you want to reduce the number of messages to be sent, modify the text of the policy so that only a selected subset of messages is sent to OMi. For details, see the OM documentation.

4. Replace `<OMi fully qualified host name>` in the text with the fully qualified hostname of the Gateway server that should receive OM messages (for example, `HPEGwSrv.example.com`).

In deployments involving a load balancer, a NAT device, or a reverse proxy, use the fully qualified hostname of the system used to access the Gateway server (for example, `VirtualSrv.example.com`).

5. Enter the following command to check for syntax errors in the new policy text:

```
/opt/OV/bin/OpC/opcmomchk -msgforw <policy file name>
```

6. After correcting any syntax errors, copy the policy to the `msgforw` policy file in the `respmgrs` directory as follows:

```
cp <policy file name> /etc/opt/OV/share/conf/OpC/mgmt_sv/respmgrs/msgforw
```

7. Inform the server processes to reread the configuration as follows:

```
/opt/OV/bin/ovconfchg
```

Message forwarding from OM to OMi is now configured and enabled.

Adapt an Active Policy

If the message forwarding policy already exists on the OM for UNIX or Linux system, complete the following steps to edit this policy and add another message target manager to it:

1. Change to the `work_respmgrs` directory as follows:

```
cd /etc/opt/OV/share/conf/OpC/mgmt_sv/work_respmgrs/
```

Note: Policy template files can be found in `/etc/opt/OV/share/conf/OpC/mgmt_sv/tmpl_respmgrs/`.

2. Edit the existing policy to which you want to add the OMi server as a target as follows:

```
vi <policy file name>
```

3. Add another message target manager as shown in the following policy text:

```
# none
RESPMGRCONFIGS
  RESPMGRCONFIG DESCRIPTION "Forward all messages to OMi"
  SECONDARYMANAGERS
  ACTIONALLOWMANAGERS
  MSGTARGETRULES
    MSGTARGETRULE DESCRIPTION "Forward all messages rule"
    MSGTARGETRULECONDS
    MSGTARGETRULECOND DESCRIPTION "Forward all messages"
    MSGTARGETMANAGERS
      MSGTARGETMANAGER
        TIMETEMPLATE "$OPC_ALWAYS"
        OPCMGR IP 0.0.0.0 "<First Target Manager>"

      MSGTARGETMANAGER
        TIMETEMPLATE "$OPC_ALWAYS"
        OPCMGR IP 0.0.0.0 "<OMi fully qualified host name>"
```

Note: This policy forwards all messages to OMi. If you want to reduce the number of messages to be sent, modify the text of the policy so that only a selected subset of messages is sent to OMi. For details, see the OM documentation.

4. Replace `<OMi fully qualified host name>` in the text with the fully qualified hostname of the Gateway Server system that should receive OM messages (for example, `HPEGwSrv.example.com`).

In deployments involving a load balancer, a NAT device, or a reverse proxy, use the fully qualified hostname of the system used to access the Gateway Server system (for example, `VirtualSrv.example.com`).

5. Enter the following command to check for syntax errors in the new policy text:

```
/opt/OV/bin/OpC/opcmomchk -msgforw <policy file name>
```

6. After correcting any syntax errors, copy the policy to the **msgforw** policy file in the **respmgrs** directory as follows:

```
cp <policy file name> /etc/opt/OV/share/conf/OpC/mgmt_sv/respmgrs/msgforw
```

7. Inform the server processes to reread the configuration as follows:

```
/opt/OV/bin/ovconfchg
```

Message forwarding from OM to OMi is now configured and enabled.

Chapter 17: How to Validate Event Synchronization

This chapter provides you with instructions on how to validate event synchronization and test the connection between OM and OMi.

Note: Make sure that you configured OM to enable OMi users to use tools, actions, and instruction text. You configure this in the Connected Servers manager in OMi. For details, see ["How to Create a Connection to an OM Server" on page 66](#).

Verify Message Forwarding from OM to OMi

To check if the message forwarding policy for sending messages from OM to OMi is configured correctly, follow these steps:

1. Make sure the OMi servers are running.
2. Make sure at least one open message interface policy is deployed on your OM system. For instructions and details, see the OM documentation.
3. On the OM system, open a command or shell prompt and create a new message by executing the following command:

- o Windows:

```
opcmmsg a=App o=Obj msg_text="Hello"
```

- o UNIX or Linux:

```
/opt/OV/bin/OpC/opcmmsg a=App o=Obj msg_text="Hello"
```

If you configured the message forwarding policy correctly, the message arrives at the OM server and is forwarded to OMi. You can view the events with the OMi Event Browser.

Note: If the message is sent multiple times, no new message is generated by OM. These messages are regarded as duplicates and only the message duplicate count is increased.

To generate a new message, modify the message text. For example:

- o Windows:

```
opcmmsg a=App o=Obj msg_text="Hello_002"
```

- UNIX or Linux:

```
/opt/OV/bin/OpC/opcmmsg a=App o=Obj msg_text="Hello_002"
```

Synchronize OMi Events with OM Messages

To check if a change to an event in OMi that is already synchronized between OMi and OM is resynchronized in OM, change the severity of an event as follows:

1. Make sure the OMi platform is running.
2. Log on to the OMi platform management console.
3. Select **Applications > Operations Management**.
4. In the Event Browser, select the event for which you want to change the severity. Choose the event that was already synchronized in OM and OMi and change its severity, for example, from minor to major.
5. Access the General tab of the Event Details pane.
6. From the Severity drop-down list, choose another severity (for example, major), and then click **Save**.
7. In the OM event browser, verify the severity of this event and make sure it was set to the new severity value.

Chapter 18: How to Set up Operations Manager i in an Environment Managed by OM

To set up OMi in an environment managed by OM, follow these steps:

1. Before installing OMi, run the following command on all data processing servers and gateway servers:

```
ovconfchg -ns sec.cm.client -set CERTIFICATE_SERVER <FQDN of primary DPS>
```
2. Install and configure OMi according to the *OMi Installation and Upgrade Guide*.
3. Integrate OM as described in "[Workflow: Configuring Connections Between Operations Manager i and OM](#)" on page 60.

Optional. How to Set Up Forwarding Targets for OM Agent Node Creation

To ensure that events are assigned to the correct CIs, the nodes in the OMi RTSM or UCMDB need to be synchronized with the OM node bank(s). You can use the **OM Agent Node Creation Forwarding Targets** infrastructure setting to forward topology data from operations agents monitored by OMi to a specified OM for Linux or Windows server(s). After the topology information is forwarded from OMi, a node is created in the OM for Linux or Windows server. The platform of the synchronized node is displayed as *other* in OM for Linux and *n/a* in OM for Windows.

To set up a forwarding target for the creation of an agent node, edit the **OM Agent Node Creation Forwarding Targets** infrastructure setting:

1. In OMi, navigate to
Administration > Setup and Maintenance > Infrastructure Settings
2. Select **Applications** and use the list to select the **Operations Management** context. Scroll down to **Operations Management - HPOM Topology Synchronization Settings**.
3. Next to the **OM Agent Node Creation Forwarding Targets** setting, click  **Edit Item**.
4. Enter your target server in the **Value** field.

If you want to enter more than one target server, separate them with a semi-colon.

5. Click **OK** to save.

Chapter 19: OMi Field Mapping

The following table shows the correspondence between the fields of an OMi event and an OM message.

OMi Event Attribute	OM Message	
	OM Message Attribute	OM Custom Message Attribute (CMA)
ID	Message ID	
Title	Message Text	
Description		Description
Lifecycle State/State (depending on space)	N/A	
Solution		Solution
Severity	Severity	
Priority		Priority
Category	Message Group	
Subcategory		SubCategory
Type	Message Type	
Related CI Hint		RelatedCiHint (incoming to OMi)
HPOM Service ID	Service Name	
Related CI	N/A	
Node	N/A	
Node Hint, DNS Name, IP Address, Core ID	node	NodeHint (incoming to OMi)
Source CI Hint, DNS Name, IP Address, Core ID	genNode	SourceCiHint (incoming to OMi)
Originating Server	origin	
Sending Server	sender	

OMi Event Attribute	OM Message	
	OM Message Attribute	OM Custom Message Attribute (CMA)
Assigned User	owner	
Assigned Group	N/A	
C (Event Browser) Because there is a parent event, the current event will be shown as being a symptom.		CauseEventId (synchronized back to OM)
C (Event Browser) Because there is at least one child event, the current event will be shown as being a cause.	N/A	
Custom Attributes	CustomMessageAttributes	
Time Created	CreationTime	
Time State Changed	N/A	
Time Received	ReceivedTime	
Duplicate Count	NumberOfDuplicates	
ETI Hint		EtiHint (incoming to OMi)
User Action	Operator Initiated Action	
Automatic Action	Automatic Action	
Application	Application	
Object	Object	
Key (only in details)	MessageKey	
Close Events with Key	Pattern of 1. MessageKeyRel	
Original Data	OriginalText	
(This field is not displayed, but events that have this attribute arrive as closed.)	logOnly	
Match Information	policy, conditionId	

OMi Event Attribute	OM Message	
	OM Message Attribute	OM Custom Message Attribute (CMA)
	(unmatched)	
Original ID (only in details)	origId	
Correlation Rule	N/A	
Source CI	N/A	
No Duplicate Suppression		NoDuplicateSuppression (incoming to OMi)
Event Type Indicator/ETI	N/A	
part of CI (after :)		SubCiHint (incoming to OMi)

Chapter 20: Troubleshooting

This section contains troubleshooting information about OM integration-related issues.

Cleanup after switching OM to another OMi server

After reconnecting OM to another OMi server, for example after activating a disaster recovery environment, you should delete the buffered messages on the OM system for the old OMi server. If the messages are left in the forwarding buffer, there may be some performance degradation as the system regularly tries to deliver them without success. They also consume some disk space. It is not possible to re-direct these messages to the new OMi server, and these cannot be synchronized.

Note: All messages currently in the buffer are deleted. It is not possible to distinguish between different targets and messages for other targets are also deleted.

To delete the forwarding buffer files on OM for Windows:

1. Stop the server processes: `vpstat -3 -r STOP`
2. Delete all files and folders contained within the following directories:
`<OvDataDir>\shared\server\datafiles\bbc\snf\data`
`<OvDataDir>\shared\server\datafiles\bbc\snf\OvEpMessageActionServer`
3. Restart the server processes: `vpstat -3 -r START`

To delete the forwarding buffer files on OM for UNIX:

1. Stop the server processes: `ovc -kill`
2. Delete all files and folders contained within the following directories:
`/var/opt/OV/shared/server/datafiles/bbc/snf/data`
`/var/opt/OV/share/tmp/OpC/mgmt_sv/snf/opcforwm`
3. Restart the server processes: `ovc -start`

Specifying the URL of a Load Balancer

If the OM server is connected to OMi by using a load balancer, the URL of the load balancer

(http://<load balancer>:80) must be specified in the infrastructure setting:

Foundation > Platform Administration > Host Configuration > Default Virtual Gateway Server for Data Collectors URL

Note: If you omit this setting, event synchronization might get confused as it is using the wrong sender hostname (the physical gateway server in place of the virtual system name).

Part V: Operations Manager i - Service Manager Integration

Chapter 21: Operations Manager i - Service Manager Integration Overview

This section describes the integration between HPE Service Manager and Operations Manager i.

If your setup uses an external UCMBD, follow the steps provided in ["OMi-SM Integration with UCMBD" on page 166](#).

If not, follow the steps provided in ["OMi-SM Integration with RTSM" on page 97](#).

Versions

In general, the information provided in this guide is for integrating OMi with SM 9.4x.

Caution: When integrating OMi with SM 9.40, make sure that one of the following patches are applied:

- HPSM_00700 - Service Manager 9.40.2001 p2 - Server for Linux
- HPSM_00701 - Service Manager 9.40.2001 p2 - Server for Solaris
- HPSM_00702 - Service Manager 9.40.2001 p2 - Server for Windows
- HPSM_00706 - Service Manager 9.40.2001 p2 - OMi Integration

Integration Options

OMi-SM Integration Options with RTSM

The following figure shows the options for integrating OMi and SM when using the RTSM. For detailed information, see ["OMi-SM Integration with RTSM" on page 97](#).

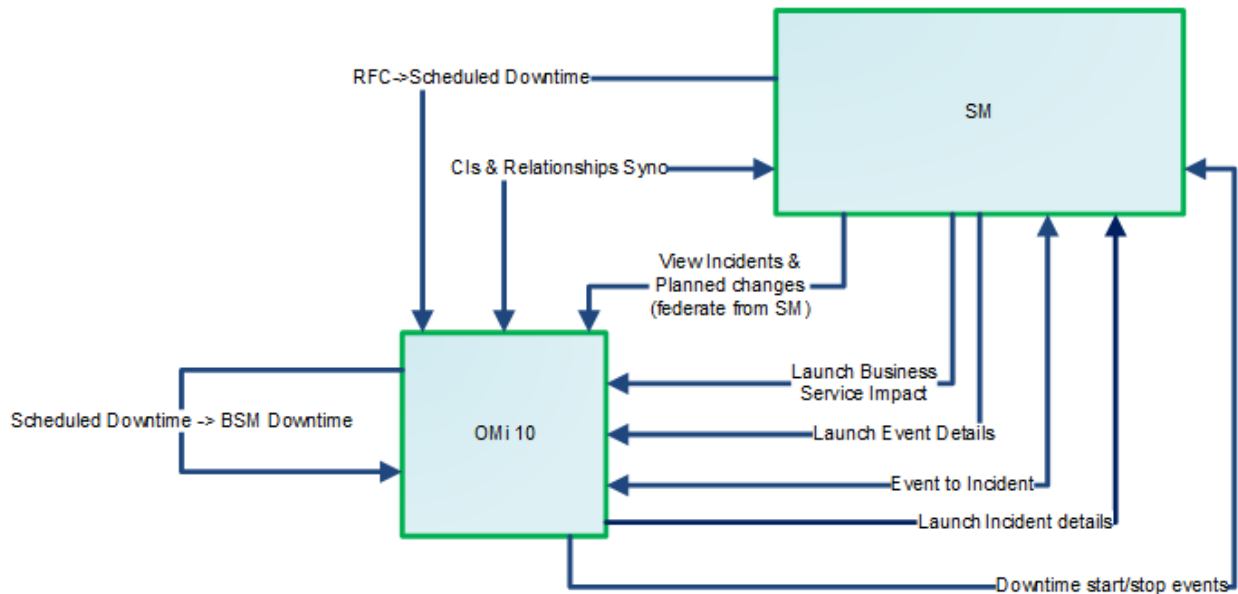

- **CIs synchronization between SM and OMi.** To enable operators of all systems to see the same CIs, important service, business application, and infrastructure CIs should be synchronized between all systems. Synchronized CIs are a prerequisite for all other integration features. For details, see ["RTSM-Service Manager Integration" on page 99](#).
- **Incident forwarding between SM and OMi.** OMi enables you to forward events from OMi to SM. Forwarded events and subsequent event changes are synchronized back from SM to OMi. You can also drill down from OMi events to SM incidents or from SM incidents to OMi events. For details, see ["Event Forwarding from OMi to SM \(RTSM\)" on page 109](#).
- **Downtime forwarding from SM to OMi.** You can create downtimes (also known as outages) in OMi based on Requests for Changes in SM. This is done in two steps. First, scheduled downtime CIs are created in OMi based on RFCs in SM. Then, a BSM downtime CI is created based on the scheduled downtime. For details, see ["Downtime Forwarding from Service Manager to OMi \(RTSM\)" on page 131](#).
- **Downtime notification from OMi to SM.** OMi can send downtime start and end events to SM to notify operators when a downtime occurs. This provides additional information to the SM operator in case of a downtime that was not driven by an RFC. For details, see ["Sending downtime notifications from OMi to SM \(RTSM\)" on page 140](#).
- **View planned changes and incident details.** This integration enables you to view planned changes and incident details in the Changes and Incidents and Hierarchy components in OMi. For details, see ["View Changes and Incidents in OMi \(RTSM\)" on page 141](#).
- The **Business Impact Report** integration enables Service Manager operators to launch an impact

report from an incident in the context of the incident's affected CI. This opens an OMi KPI over time page, displaying the affected CI and impacted CIs and services, which allows the operator to categorize and prioritize the incident accordingly. For details, see ["Business Impact Report \(BIR\) \(RTSM\)" on page 148](#).

OMi-SM Integration Options with UCMDB

The following figure shows the options for integrating OMi and SM when using a UCMDB. For detailed information, see ["OMi-SM Integration with UCMDB" on page 166](#).

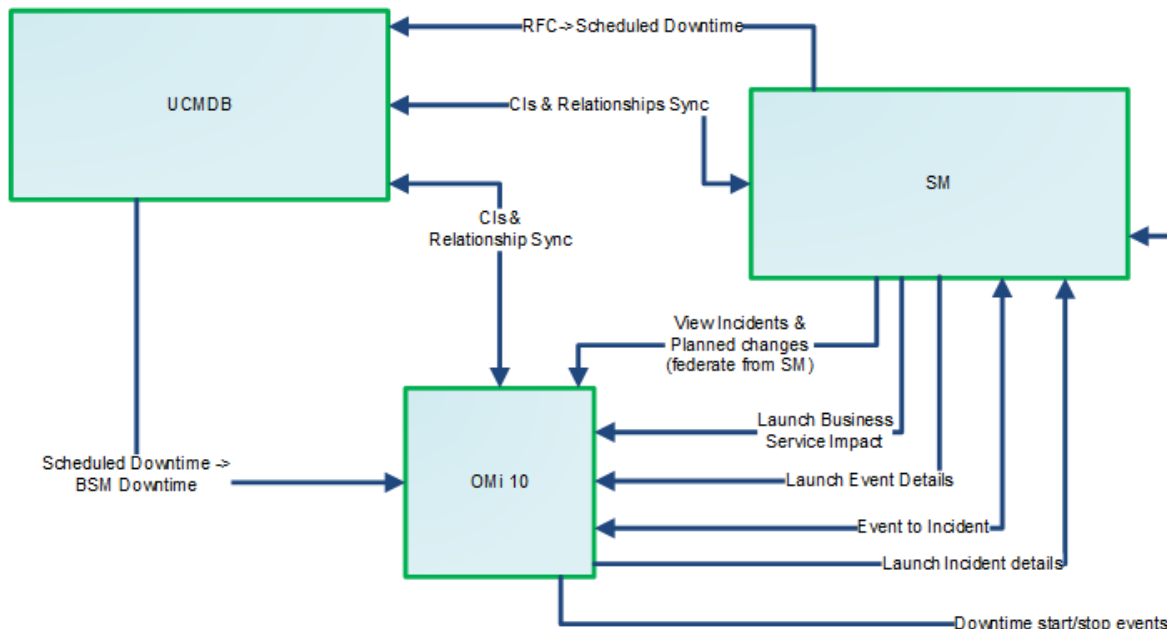

- CIs synchronization between SM and UCMDB.** To enable operators of all systems to see the same CIs, important service, business application, and infrastructure CIs should be synchronized between all systems. Synchronized CIs are a prerequisite for all other integration features. With an external UCMDB, CIs are synchronized from SM to the UCMDB system and vice versa (for details, see ["UCMDB-Service Manager Integration" on page 169](#)), and from the UCMDB system to OMi and vice versa (for details, see ["OMi-UCMDB Integration" on page 169](#)). In this case, the UCMDB acts as Global ID generator.
- Incident forwarding between SM and OMi.** OMi enables you to forward events from OMi to SM. Forwarded events and subsequent event changes are synchronized back from SM to OMi. You can also drill down from OMi events to SM incidents or from SM incidents to OMi events. For details, see ["Event Forwarding from OMi to SM \(UCMDB\)" on page 179](#).
- Downtime forwarding from SM to OMi.** You can create downtimes (also known as outages) in

OMi based on Requests for Changes in SM. This is done in two steps. First, scheduled downtime CIs are created in UCMDB based on RFCs in SM. Then, a BSM downtime CI is created in OMi based on the scheduled downtime. For details, see ["Downtime Forwarding from Service Manager to OMi \(UCMDB\)" on page 201](#).

- **Downtime notification from OMi to SM.** OMi can send downtime start and end events to SM to notify operators when a downtime occurs. This provides additional information to the SM operator in case of a downtime that was not driven by an RFC. For details, see ["Sending downtime notifications from OMi to SM \(UCMDB\)" on page 210](#).
- **View planned changes and incident details.** This integration enables you to view planned changes and incident details in the Changes and Incidents and Hierarchy components in OMi. For details, see ["View Changes and Incidents in OMi \(UCMDB\)" on page 212](#).
- The **Business Impact Report** integration enables Service Manager operators to launch an impact report from an incident in the context of the incident's affected CI. This opens an OMi KPI over time page, displaying the affected CI and impacted CIs and services, which allows the operator to categorize and prioritize the incident accordingly. For details, see ["Business Impact Report \(BIR\) \(UCMDB\)" on page 218](#).

Chapter 22: OMi-SM Integration with RTSM

This section describes integrating OMi with Service Manager in the case where the RTSM contained in OMi is used as CMDB.

This section includes:

- ["Data Flow Probe" below](#)
- ["Create User Accounts for the OMi-SM Integration \(RTSM\)" on the next page](#)
- (prerequisite) ["RTSM-Service Manager Integration" on page 99](#)
- ["Enable LW-SSO for the OMi-SM Integration \(RTSM\)" on page 100](#)
- ["View Actual State in SM \(RTSM\)" on page 108](#)
- ["Event Forwarding from OMi to SM \(RTSM\)" on page 109](#)
- ["Downtime Forwarding from Service Manager to OMi \(RTSM\)" on page 131](#)
- ["Sending downtime notifications from OMi to SM \(RTSM\)" on page 140](#)
- ["View Changes and Incidents in OMi \(RTSM\)" on page 141](#)
- ["Business Impact Report \(BIR\) \(RTSM\)" on page 148](#)

Data Flow Probe

The OMi-SM Integration uses a Data Flow Probe to exchange data. This DFP can be installed on one of the OMi Gateway or Data Processing Server systems or on a separate system. HPE recommends installing it on an OMi Gateway system as this avoids setting up an additional system.

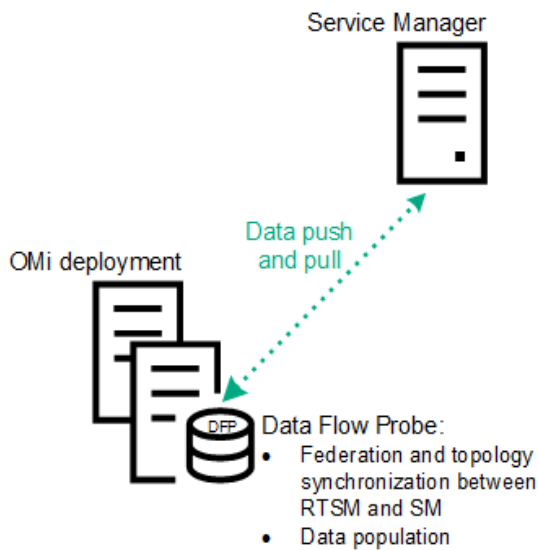

The Data Flow Probe is necessary for

- Populating the RTSM with CIs & Relationships
- Pushing CIs & Relationships to SM
- Federating Incidents and Changes into RTSM
- Populating the RTSM with downtimes

Create User Accounts for the OMi-SM Integration (RTSM)

The OMi-SM integration requires integration accounts to be set up for the two systems to access each other.

1. In Service Manager, create an operator record with system administration privileges, and give it a descriptive name, like `OMiSMIntegrUser`.

To create a dedicated integration user account in SM:

- a. Log on to SM as a system administrator.
- b. Type **contacts** in the SM command line, and press **ENTER**.
- c. Create a new contact record for the integration user account.

- i. In the **Full Name** field, type a full name. For example, RTSM.
 - ii. In the **Contact Name** field, type a name. For example, RTSM.
 - iii. Click **Add**, and then **OK**.
- d. Type **operator** in the SM command line, and press **ENTER**.
- e. In the **Login Name** field, type the user name of an existing system administrator account, and click **Search**.

The system administrator account displays.

- f. Create a new user account based on the existing one:
 - i. Change the **Login Name** to the integration account name you want (for example, `rtsm`).
 - ii. Type a **Full Name**. For example, RTSM.
 - iii. In the **Contact ID** field, click the **Fill** button and select the contact record you have just created.
 - iv. Click **Add**.
 - v. Select the **Security** tab, and change the password.
 - vi. Click **OK**.

This is the user account that the OMi server uses to access Service Manager. It is used to forward events, push CIs to, and retrieve incidents and RFCs from Service Manager. Remember the user name and password you specify here, as the OMi system will need them to access the Service Manager target server in later steps.

2. On each OMi server, create a user account with system administration privileges. This account is used by SM to access the OMi system to retrieve the actual state information of a CI. Give it a descriptive name, like `SMOMiIntegrUser`.

Remember the user name and password you specify here, as Service Manager will need the accounts to access the OMi server(s) in later steps.

RTSM-Service Manager Integration

Many of the integration features require that Configuration Items (CIs) exist in both Service Manager and OMi. To enable operators of both systems to see the same CIs, they should be synchronized between the two systems. For details about how to integrate OMi RTSM with Service Manager, see the *HPE Service Manager Universal CMDB Integration Guide*. This integration, which synchronizes

important CIs, such as services, business applications and infrastructure CIs, is a prerequisite for all other integration features.

Enable LW-SSO for the OMi-SM Integration (RTSM)

Lightweight Single Sign-On (LW-SSO) is optional but recommended for the OMi-SM Integration. You have different LW-SSO configuration choices depending on your needs. The following describes how LW-SSO can be used in the OMi-SM workflow.

LW-SSO options for the OMi-SM integration

When OMi creates an incident from an OMi event record

OMi creates an incident from an OMi event record by sending RESTful-based requests to Service Manager. The incident ID is then stored in the event record.

LW-SSO is NOT needed in this process. A dedicated Service Manager user account was specified when configuring the Service Manager integration in OMi. OMi uses this dedicated user account when calling the Service Manager RESTful Web Service to create the incident.

When an OMi user views the incident details

The user can log in to Service Manager and view the incident details by using the incident ID stored in the event record.

If the user wants to view the incident details by clicking the incident link from the event record, LW-SSO can be used; otherwise a Service Manager login prompt will appear.

LW-SSO is optional for this process. To enable LW-SSO for this process, configure LW-SSO in both the Service Manager server and Web tier (because the server needs to trust the Web tier), as well as in OMi.

When Service Manager synchronizes the OMi incident status back to OMi

When a user has updated the OMi incident, Service Manager calls the OMi server's RESTful Web Service to update the incident changes to the OMi event record.

LW-SSO is NOT needed in this process. A dedicated OMi user account was specified when the Incident Exchange (OMi - SM) integration was set up in SMIS, and Service Manager uses this user account when calling the OMi server's RESTful Web Service to synchronize the incident status back to the OMi event record.

When a user views the event details or the Business Impact Report from an OMi incident

The user clicks the **View OMi Event** option or **Launch Business Impact Report** from the incident to view the event details or Business Impact Report.

LW-SSO is optional for this process. If you enable LW-SSO in the Service Manager Web tier and in OMi, the OMi login prompt is bypassed.

Required user permissions

In order to be able to view events, a user needs to be assigned a role with sufficient permission to read events. To manage permissions in OMi, select:

Administration > Users > Users, Groups, and Roles

Select a role or create a new one. In the Permissions section, go to the **Operations Console** category, select **Events** and specify the actions users can perform on **Events assigned to user**.

You can optionally grant the permission to view events not assigned to each user.

When CIs are synchronized between OMi/UCMDB and SM

LW-SSO is NOT needed in this process. Dedicated users are specified in the OMi-UCMDB, UCMDB-SM and OMi-SM integration points.

Configuring LW-SSO for the OMi-SM integration

To use LW-SSO for the SM-OMi integration, LW-SSO must be enable for both products. In SM, you must enable LW-SSO in both the SM server and web tier.

Step 1: Configure LW-SSO in the SM server

Service Manager servers, version 9.30 and later, support Lightweight Single Sign-On (LW-SSO). A Service Manager integration can pass an authentication token to Service Manager and does not require re-authentication. This simplifies the configuration of Single Sign-On for HPE solutions by removing the

need to use Symphony Adapter (which proxies LW-SSO-based authentication with the Service Manager Trusted Sign-On solution).

Enabling LW-SSO in the Service Manager server enables web service integrations from other HPE products (for example, Release Control) to bypass Service Manager authentication if the product user is already authenticated and a proper token is used; enabling LW-SSO in both the Service Manager server and web tier enables users to bypass the login prompts when launching the Service Manager web client from other HPE applications.

Note: Existing integrations that use the Symphony Adapter and Trusted Sign-On rather than this new LW-SSO mechanism can continue to work.

To configure LW-SSO in the Service Manager server:

1. Go to the <Service Manager server installation path>/RUN folder, and open `lwssofmconf.xml` in a text editor.
2. Make sure that the `enableLWSSOFramework` attribute is set to `true` (default).
3. Change the domain value `example.com` to the domain name of your Service Manager server host.

Note: To use LW-SSO, your Service Manager web tier and server must be deployed in the same domain; therefore you should use the same domain name for the web tier and server. If you fail to do so, users who log in from another application to the web tier can log in but may be forcibly logged out after a while.

4. Set the `initString` value. This value MUST be the same with the LW-SSO setting of the other HPE product you want to integrate with Service Manager.

Note:

- LW-SSO version 2.5 is supported.
- Optionally, you can change attributes `paddingModeName`, `keySize`, `encodingMode`, `engineName`, and `cipherType`. However, you must make sure that they are same with the LW-SSO setting of the other HPE product that you want to integrate with Service Manager.
- Do not change the other configurations, such as the content in tag `<restURLs>`, and the attribute of tag `<service>`.

Example:

```
<?xml version="1.0" encoding="UTF-8"?>
<lwss-config xmlns="http://www.hpe.com/astsecurity/idmenablmentfw/lwssso/2.0">
  <enableLWSSO enableLWSSOFramework="true"
    enableCookieCreation="true" cookieCreationType="LWSSO" />
  <web-service>
```

```

<inbound>
  <restURLs>
    <url>.*7/ws.*</url>
    <url>.*sc62server/ws.*</url>
    <url>.*ui.*</url>
  </restURLs>
  <service service-type="rest" >
    <in-lwssso>
      <lwsssoValidation>
        <domain>example.com</domain>
        <crypto cipherType="symmetricBlockCipher" engineName="AES"
          paddingModeName="CBC" keySize="256" encodingMode="Base64Url"
          initString="This is a shared secret passphrase"</crypto>
      </lwsssoValidation>
    </in-lwssso>
  </service>
</inbound>
<outbound/>
</web-service>
</lwssso-config>

```

Step 2: Configure LW-SSO in the SM Web Tier

If Lightweight Single Sign-On (LW-SSO) is enabled in the Service Manager Web tier, integrations from other HPE products will bypass Service Manager authentication when launching the Service Manager Web client, provided that the HPE product user is already authenticated and a proper token is used.

Note:

- To enable users to launch the Web client from another HPE product by using LW-SSO, you must also enable LW-SSO in the Service Manager server.
- Once you have enabled LW-SSO in the web tier, web client users should use the web tier server's fully-qualified domain name (FQDN) in the login URL:
<http://<myWebtierHostName>.<myDomain>:<port>/webtier-x.xx/index.do>

The following procedure is provided as an example, assuming that the Service Manager Web tier is deployed on Tomcat.

To configure LW-SSO in the Service Manager Web tier:

1. Open the <Tomcat>\webapps\< Service Manager web tier>\WEB-INF\web.xml file in a text editor.
2. Modify the web.xml file as follows:

- a. Set the `<serverHost>` parameter to the fully-qualified domain name of the Service Manager server.

Note: This is required to enable LW-SSO from the web tier to the server.

- b. Set the `<serverPort>` parameter to the communications port of the Service Manager server.
- c. Set the `secureLogin` and `sslPort` parameters.

- If you do not want to configure TLS between Tomcat and the browser, set `secureLogin` to `false`.
- We recommend that you enable secure login in a production environment. Once `secureLogin` is enabled, you must configure TLS for Tomcat. For details, see the Apache Tomcat documentation.

- d. Change the value of context parameter **isCustomAuthenticationUsed** to `false`.
- e. Remove the comment tags (`<!--` and `-->`) enclosing the following elements to enable LW-SSO authentication.

```
<!--
  <filter>
    <filter-name>LWSSO</filter-name>
    <filter-class>com.hp.sw.bto.ast.security.lwssso.LWSSOFilter</filter-
class>
  </filter>
-->
.....
<!--
  <filter-mapping>
    <filter-name>LWSSO</filter-name>
    <url-pattern>/*</url-pattern>
  </filter-mapping>
-->
```

- f. Save the `web.xml` file.
3. Open the `<Tomcat>\webapps\<Service Manager Web tier>\WEB-INF\classes\lwssofmconf.xml` file in a text editor.
 4. Modify the `lwssofmconf.xml` file as follows:
 - a. Set the value of `enableLWSSOFramework` to `true` (default is `false`).
 - b. Set the `<domain>` parameter to the domain name of the server where you deploy your Service Manager Web tier. For example, if your Web tier's fully qualified domain name is `mywebtier.domain.example.com`, then the domain portion is `domain.example.com`.

Note: To use LW-SSO, your Service Manager web tier and server must be deployed in the same domain; therefore you should use the same domain name for the web tier and server. If you fail to do so, users who log in from another application to the web tier can log in but may be forcibly logged out after a while.

- c. Set the `<initString>` value to the password used to connect HPE applications through LW-SSO (minimum length: 12 characters). For example, `smintegrationlwssso`. Make sure that other HPE applications (for example, Release Control) connecting to Service Manager through LW-SSO share the same password in their LW-SSO configurations.
- d. In the `<multiDomain>` element, set the trusted hosts connecting through LW-SSO. If the Service Manager web tier server and other application servers connecting through LW-SSO are in the same domain, you can ignore the `<multiDomain>` element ; If the servers are in multiple domains, for each server, you must set the correct `DNSDomain` (domain name), `NetBiosName` (server name), `IP` (IP address), and `FQDN` (fully-qualified domain name) values. The following is an example.

```
<DNSDomain>example.com</DNSDomain>
<NetBiosName>myserver</NetBiosName>
<IP>1.23.456.789</IP>
<FQDN>myserver.example.com</FQDN>
```

Note: As of version 9.30, Service Manager uses `<multiDomain>` instead of `<protectedDomains>`, which is used in earlier versions. The multi-domain functionality is relevant only for UI LW-SSO (not for web services LW-SSO). This functionality is based on the HTTP referrer. Therefore, LW-SSO supports links from one application to another and does not support typing a URL in a browser window, except when both applications are in the same domain.

- e. Check the `secureHTTPCookie` value (default: true).
 - If you set `secureHTTPCookie` to true (default), you must also set `secureLogin` in the `web.xml` file to true (default); if you set `secureHTTPCookie` to false, you can set `secureLogin` to either true or false. In a production environment, you are recommended to set both parameters to true.
 - If you do not want to use TLS, set both `secureHTTPCookie` and `secureLogin` to false.

Here is an example of `lwssofmconf.xml`:

```

<?xml version="1.0" encoding="UTF-8"?>
<lwssso-config
xmlns="http://www.hp.com/astsecurity/idmenablmentfw/lwssso/2.0">

  <enableLWSSO
    enableLWSSOFramework="true"
    enableCookieCreation="true"
    cookieCreationType="LWSSO"/>

  <webui>
    <validation>
      <in-ui-lwssso>
        <lwsssoValidation id="ID000001">
          <domain>example.com</domain>
          <crypto cipherType="symmetricBlockCipher"
            engineName="AES" paddingModeName="CBC" keySize="256"
            encodingMode="Base64Url"
            initString="This is a shared secret passphrase"/>
        </lwsssoValidation>
      </in-ui-lwssso>

      <validationPoint
        enabled="false"
        refid="ID000001"
        authenticationPointServer="http://server1.example.com:8080/bsf"/>

    </validation>

    <creation>
      <lwsssoCreationRef useHTTPOnly="true" secureHTTPCookie="true">
        <lwsssoValidationRef refid="ID000001"/>
        <expirationPeriod>50</expirationPeriod>
      </lwsssoCreationRef>
    </creation>

    <logoutURLs>
      <url>./goodbye.jsp.</url>
      <url>./cwc/logoutcleanup.jsp.</url>
    </logoutURLs>

    <nonsecureURLs>
      <url>./images/.</url>
      <url>./js/.</url>
      <url>./css/.</url>
      <url>./cwc/tree/.</url>
      <url>./sso_timeout.jsp.</url>
    </nonsecureURLs>

```

```

    <multiDomain>
      <trustedHosts>
        <DNSDomain>example.com</DNSDomain>
        <DNSDomain>example1.com</DNSDomain>
        <NetBiosName>myserver</NetBiosName>
        <NetBiosName>myserver1</NetBiosName>
        <IP>xxx.xxx.xxx.xxx</IP>
        <IP>xxx.xxx.xxx.xxx</IP>
        <FQDN>myserver.example.com</FQDN>
        <FQDN>myserver1.example1.com</FQDN>
      </trustedHosts>
    </multiDomain>
  </webui>

  <lwssso-plugin type="Acegi">
    <roleIntegration
      rolePrefix="ROLE_"
      fromLWSSO2Plugin="external"
      fromPlugin2LWSSO="enabled"
      caseConversion="upperCase"/>

    <groupIntegration
      groupPrefix=""
      fromLWSSO2Plugin="external"
      fromPlugin2LWSSO="enabled"
      caseConversion="upperCase"/>
  </lwssso-plugin>
</lwssso-config>

```

f. Save the `lwsssofmconf.xml` file.

5. Open the `<Tomcat>\webapps\<Service Manager Web tier>\WEB-INF\classes\application-context.xml` in a text editor.

6. Modify the `application-context.xml` as follows:

a. Add `lwSsoFilter` to `filterChainProxy`:

```

/**=httpSessionContextIntegrationFilter,
lwSsoFilter,anonymousProcessingFilter

```

Note: If you need to enable web tier LW-SSO for integrations and also enable trusted sign-on for your web client users, add `lwSsoFilter` followed by `preAuthenticationFilter`, as shown in the following:

```

/**=httpSessionContextIntegrationFilter,
lwSsoFilter,preAuthenticationFilter,anonymousProcessingFilter.

```

- b. Uncomment bean lwSsoFilter:

```
<bean id="lwSsoFilter"  
class="com.hp.ov.sm.client.webtier.lwssso.LwSsoPreAuthenticationFilter">
```

- c. Save the application-context.xml file.
7. Repack the updated Service Manager web tier files and replace the old web tier .war file deployed in the <Tomcat>\webapps folder.
8. Restart Tomcat so that the configuration takes effect.

Step 3: Configure LW-SSO in OMi

- In OMi:
 - a. Navigate to Authentication Management:
Administration > Users > Authentication Management
 - b. In the Single Sign-On Configuration section, click  **Edit** to open Single Sign On Editor panel.
 - c. In the Single Sign On Editor panel, select **Lightweight**.
 - d. Paste the **Token Creation Key (initString)** value that you copied above from **JMX to get/set Token Creation Key (initString)** to the **Token Creation String (initString)**.
 - e. Click **Save** to save your configuration.

For details on configuring LW-SSO, see the *OMi Administration Guide*.

View Actual State in SM (RTSM)

To display the Actual State information in the SM configuration item form, do the following:

1. Log on to SM as a system administrator.
2. Click **System Administration > Base System Configuration > Miscellaneous > System Information Record**.
3. Click the **Active Integrations** tab.
4. Select the **HP Universal CMDB** option.

The form displays the UCMDB web service URL field.

5. In the UCMDB web service URL field, type the URL to the Universal CMDB web service API. The URL has the following format:
http://<UCMDB server name>:<port>/axis2/services/ucmdbSMService
6. Specify the credentials for the user you created in "[Create User Accounts for the OMi-SM Integration \(RTSM\)](#)" on page 98 to access the OMi server.
7. Click **Save**. SM displays the message: **Information record updated**.
8. Log out of the SM system.
9. To verify that the setup worked, log back into the SM system with an administrator account. The **Actual State** section will be available in CI records pushed from OMi.

Event Forwarding from OMi to SM (RTSM)

OMi enables you to forward events from OMi to Service Manager, which then become incidents in Service Manager. Subsequent event/incident changes are synchronized between Service Manager and OMi. You can also drill down from OMi events to Service Manager incidents and vice versa.

Follow the steps below to set up an incident exchange between Service Manager and OMi.

This section includes:

- "[Step 1: Configure the Service Manager server as a connected server in OMi](#)" below
- "[Step 2: \(optional\) Configure an Event Forwarding Rule](#)" on page 113
- "[Step 3: Configure the OMi integration in Service Manager](#)" on page 114
- "[Step 4: Configure Launch of Service Manager Incident Details from OMi](#)" on page 119
- "[\(optional\) Step 5: Attribute Synchronization](#)" on page 120
- "[Step 6: Test the Event Forwarding and Cross Launches](#)" on page 125
- "[Advanced Configuration](#)" on page 127

Step 1: Configure the Service Manager server as a connected server in OMi

To synchronize events and event changes between OMi and Service Manager incidents, configure Service Manager as a target connected server in the OMi Connected Servers manager.

To configure the Service Manager server as a target connected server, perform the following steps:

1. Navigate to the Connected Servers manager:

Administration > Setup and Maintenance > Connected Servers

2. In the central Connected Servers pane, click *** New** and select **External Event Processing**. Alternatively, you can click *** New** in the External Event Processing area in the right pane.

The Create External Event Processing Server panel opens.

3. In the General section, enter a display label (a name for the target Service Manager server), an identifier (a unique internal name if you want to replace the automatically generated one), and, optionally, a description of the connection being specified.

Note: The Identifier field is filled in automatically. For example, if you enter *Service Manager 1* as the display label for the target Service Manager server, *Service_Manager_1* is automatically inserted in the Identifier field.

Make a note of the name of the new target server (in this example, *Service_Manager_1*). You must provide it later as the user name when configuring the Service Manager server to communicate with the server hosting OMi.

4. In the Server Properties section, complete the following information:
 - a. Enter the fully qualified domain name of the Service Manager target server.
 - b. From the drop-down list, select the **Service Manager System** CI type.
 - c. *Optional.* Customize the way events and change notifications are delivered to this server by using Advanced Delivery Options:
 - **Serial:** Events and change notifications are delivered serially in the order in which they were received.
 - **Serial per source:** *Default.* Each originating server is provided with a dedicated outgoing request delivery path. For each individual outgoing request delivery path, events and change notifications are delivered serially in the order in which they were received. This can increase the throughput for delivery of events and change notifications when many events are received from multiple originating servers, while maintaining the incoming order.
 - **Parallel:** The configured number of outgoing request delivery paths is used when forwarding events and change notifications. This can further increase the throughput for delivery of events and change notifications. However, because the source of the event is not considered, maintenance of the incoming order cannot be guaranteed.
5. In the Integration Type section, complete the following information:

- a. Select **Call Script Adapter** as the integration type.
 - b. From the Script name drop-down list, select the Service Manager Groovy script adapter **sm:ServiceManagerAdapter**.
 - c. Specify a maximum transaction time value (the time limit for the execution of the script). The default value is 60 seconds.
6. In the Outgoing Connection section, enter the user credentials (user name and password) and the port number required to access the Service Manager target server and to forward events to that server:
- a. In the Username field, enter the user name for the integration user you set up in Service Manager.
 - b. In the Password field, enter the password for the user you specified. Repeat the password for verification.
 - c. In the Port field, specify the port configured on the Service Manager side for the integration with OMi.

To find the port number to enter:

- If you are using default ports in Service Manager, select or clear **Use secure HTTP** as appropriate, and then click **Set default port**. The port is set automatically.

Note: If you do not want to use secure HTTP, make sure that the **Use secure HTTP** check box is cleared.

If the Use secure HTTP check box is selected, download and install a copy of the target server's TLS certificate by clicking **import the certificate**, and then clicking the **Connect and Import from Server** or **Import from File** button, if the certificate is available in a local file.

- If you need to find the port number, access the following file on your Service Manager system:

```
<Service Manager root directory>/HP/Service Manager  
<version>/Server/RUN/sm.cfg
```

In the `sm.cfg` file, check for the `sm -loadBalancer` line and add the port entry at the end of the line. The line looks similar to this:

```
sm -loadBalancer -httpPort:13080
```

Enter the appropriate value of the port used by Service Manager in the **Port** field of the Outgoing Connection section.

- d. Select the **Enable synchronize and transfer control** check box.

If the Enable synchronize and transfer control check box is selected, an OMi operator can transfer ownership of the event to the target connected server by using the Transfer Control option in the Event Browser context menu. If it is not selected, the Synchronize and Transfer Control option is not available from the Event Browser context menu or from the list of forwarding types for configuring forwarding rules.

7. In the Incoming Connection section, select the **Accept event changes from external event processing server** check box, and then enter a password that the Service Manager server requires to connect to the server hosting OMi.

Note: Make a note of this password. You must provide it later when configuring the Service Manager server to communicate with the server hosting OMi. This password is associated with the user name (`Service_Manager_1`) you configured in Service Manager.

If **Enable synchronize and transfer control** was previously selected, the **Accept event changes from external event processing server** option is assumed and cannot be disabled.

8. In the Event Drilldown section, complete the following information:
 - a. Enter the fully qualified domain name and port of the Service Manager system into which you want to perform the incident drill down. The default port value is automatically inserted and can be restored by clicking **Set default port**.

Note: To enable incident drill down to Service Manager, you must install a web tier client for your Service Manager server according to your Service Manager server installation or configuration instructions.

In the **Event Drilldown** section, configure the server where you installed the web tier client along with the configured port used.

If you do not specify a server in the Event Drilldown section, it is assumed that the web tier client is installed on the server used for forwarding events and event changes to SM, and receiving event changes back from Service Manager.

If nothing is configured in the Event Drilldown section, and the web tier client is not installed on the Service Manager server machine, the web browser will not be able to find the requested URL.

- b. *Optional.* Select the **Use secure HTTP** check box for secure communication.
9. In the Test Connection section, click  **Run Test** to check that the specified connection

attributes are correct. If an error message is displayed, correct the connection information, and retest the connection.

10. Make sure that the **Activate after save** check box is selected if you want to enable the server connection immediately.
11. Click **Create**. The target Service Manager server appears in the list of connected servers.
12. If you have SM 9.34 or higher, perform the following additional steps:
 - a. Reopen the Service Manager connected server that you configured in the previous steps. To do so, double-click the connected server entry in the connected servers list.
 - b. Copy the ID of the connected server and save it. You must specify this ID as `omi.mgr.id` on the Service Manager system.

An example of a connected server ID is as follows:

ID: 22f42836-fd36-473e-afc9-a81290f4f73b

Step 2: (optional) Configure an Event Forwarding Rule

Once you have configured the Service Manager server as a connected server in OMi, you can forward events manually by using **Transfer Control To** from the Context Menu. If you want to automatically forward events, you can configure an Event Forwarding Rule for the OMi server.

1. Open the Event Forwarding manager:

Administration > Event Processing > Automation > Event Forwarding

2. In the **Event Forwarding Rules** pane, click the  **New Item** button to open the **Create New Event Forwarding Rules** dialog box.
3. Enter a display name, and (optional) a description of the event forwarding rule being specified.
4. Select **Active**. A rule must be active in order for its status to be available in Service Manager.
5. Select an event filter for the event forwarding rule from the **Events Filter** list. The filter determines which events to consider for forwarding.

Filters for Event Forwarding Rules can screen events based on the following date-related event attributes which, for example, help you to ignore outdated events:

- Time Created
- Time Received

- o Time Lifecycle State Changed
4. If no appropriate filter is already configured, create a new filter as follows:
 - a. Click the  **New Item** button to open the **Filter Configuration** dialog box. You can choose between New Simple Filter or New Advanced Filter.
 - b. In the **Display Name** field, enter a name for the new filter, in this example, FilterCritical.
Clear the check boxes for all severity levels except for the severity Critical.
Click **OK**.
 - c. You should see your new filter in the Select an Event Filter dialog box (select it, if it is not already highlighted).
Click **OK**.
 6. Under **Target Servers**, select the target server you configured in the previous step on connecting servers. Click the **Add** button next to the target servers selection field. You can now see the connected server's details. In the **Forwarding Type** field, select the **Synchronize and Transfer Control** forwarding type. Although other selections are technically possible, only Synchronize and Transfer Control is supported by Service Manager.

Step 3: Configure the OMi integration in Service Manager

Service Manager can integrate with more than one OMi server. To configure more than one server, first complete ["Configure the Instance Count in the Service Manager-OMi integration template"](#) below before adding integration instances. To proceed with the default of one server, skip to ["Add an SMOMi integration instance for each OMi server"](#) on the next page.

Configure the Instance Count in the Service Manager-OMi integration template

To integrate Service Manager with more than one OMi server, configure the Instance Count setting in the SMOMi integration template, as described below.

1. Log on to Service Manager as a system administrator.
2. Type `db` in the command line, and press Enter.
3. In the **Table** field, type `SMISRegistry`, and click **Search**.

The SMIS integration template form opens.

4. Click **Search**.

A list of SMIS integration templates opens.

5. Select **SMOMi** from the list.

6. In the **Instance Count** field, change the value of 1 to the number of OMi servers that you want to integrate with Service Manager. For example, if you need two OMi servers, change the value to 2.

7. Click **Save**.

Add an SMOMi integration instance for each OMi server

Once you have completed configuration in OMi, you are ready to add and enable a separate integration instance in Service Manager for each OMi server.

To add and enable an Incident Exchange (OMi - SM) integration instance:

1. Log on to Service Manager as a system administrator.

2. Click **Tailoring > Integration Manager**.

3. Click **Add**.

The Integration Template Selection wizard opens.

4. Select **SMOMi** from the Integration Template list.

Note: Ignore the **Import Mapping** check box, which has no effect on this integration.

5. Click **Next**.

6. Complete the integration instance information:

- Modify the **Name** and **Version** fields to the exact values you need.
- In the **Interval Time (s)** field, enter a value. For example: 600. If an OMi opened incident fails to be synchronized back to OMi, Service Manager will retry the failed task at the specified interval (for example, 600 seconds).
- In the **Max Retry Times** field, enter a value. For example: 10. This is the maximum allowed number of retries for each failed task.
- (Optional) In the **SM Server** field, specify a display name for the Service Manager server host. For example: my_Local_SM.
- (Optional) In the **Endpoint Server** field, specify a display name for the OMi server host. For example: my_OMi_1.

- (Optional) In the **Log File Directory** field, specify a directory where log files of the integration will be stored. This must be a directory that already exists on the Service Manager server host.
 - (Optional) In the **Log Level** field, change the log level from INFO (default) to another level. For example: **WARNING**.
 - (Optional) If you want this integration instance to be automatically enabled when the Service Manager Server service is started, select **Run at system startup**.
7. Click **Next**. The Integration Instance Parameters page opens.
 8. On the **General Parameters** tab, complete the following fields as necessary:

Field	Sample Value	Description
omi.server.url	http://<servername>:opr-gateway/rest/synchronization/event/	This is the URL address of the OMi server's RESTful web service. Replace <servername> with the fully qualified domain name of your OMi server.
http.conn.timeout	30	The HTTP connection timeout setting in seconds. Note: The out-of-box value is 30 (seconds), and 15 (seconds) is used if this field is empty.
http.rec.timeout	30	The HTTP receive timeout setting in seconds. Note: The out-of-box value is 30 (seconds), and 15 (seconds) is used if this field is empty.
http.send.timeout	30	The HTTP send timeout setting in seconds. Note: The out-of-box value is 30 (seconds), and 15 (seconds) is used if this field is empty.
sm.mgr.id	55436DBE-F81E-4799-BA05-65DE9404343B	The Universally Unique Identifier (UUID) automatically generated for this instance of Service

Field	Sample Value	Description
		<p>Manager.</p> <p>Note: This field is automatically completed each time when you add an SMOMi integration instance. Do not change it, otherwise the integration will not work properly.</p>
omi.reference.prefix	urn:x-hp:2009:opr:	<p>The prefix of the BDM External Process Reference field, which will be present in incoming synchronization requests from the OMi server.</p> <p>Note: This field is automatically completed and has a fixed value. Do not change it.</p>
sm.reference.prefix	urn:x-hp:2009:sm:	<p>The prefix of the BDM External Process Reference field, which will be present in outgoing synchronization requests from Service Manager.</p> <p>Note: This field is automatically completed and has a fixed value. Do not change it.</p>
omi.eventdetail.baseurl	http://<servename>/opr-console/opr-evt-details.jsp?eventId=	<p>The basic URL address of the event detail page in OMi. Replace <servename> with the fully qualified domain name of your OMi server.</p>

- On the **General Parameters** and **Secure Parameters** tabs, enter three parameter values that you specified when configuring the Service Manager server as a connected server in OMi. The following table lists the parameters, whose values you can copy from your OMi server.

To copy the parameter values from OMi, follow these steps:

- a. Log in to OMi as a system administrator.
- b. Navigate to **Administration > Setup and Maintenance > Connected Servers**.
- c. Locate your Service Manager server configuration entry and double-click it.
- d. In the General section, copy the **ID** string into the **omi.mgr.id** field in Service Manager.
- e. In the Incoming Connection section, copy the User name and Password to the username and Password fields in Service Manager, respectively.

Field	Sample Value	Description
omi.mgr.id (on the General Parameters tab)	f3832ff4- a6b9-4228- 9fed- b79105afa3e4	The Universally Unique Identifier (UUID) automatically generated in OMi for the target Service Manager server. Note: This parameter was introduced to support multiple OMi servers. Service Manager uses the UUID to identify from which OMi server an incident was opened. Be aware that if you delete the connected server configuration for the Service Manager server in OMi and then recreate the same configuration, OMi generates a new UUID. You must reconfigure the integration instance by changing the old UUID to the new one. Tip: If you have only one OMi server, you can simply remove this parameter (remove both the parameter name and value) from the integration instance.
username omi.mgr.id (on the General Parameters tab)	SM_Server	This is the user name that the Service Manager server uses to synchronize incident changes back to the OMi server.
Password (on the Secure Parameters tab)	SM_Server_ Password	This is the password that the Service Manager server uses to synchronize incident changes back to the OMi server.

10. Click **Next** twice, and then click **Finish**.

Note: Leave the Integration Instance Mapping and Integration Instance Fields settings blank. This integration does not use these settings.

Service Manager creates the instance. You can edit, enable, disable, or delete it in Integration Manager.

11. Enable the integration instance.
12. If you have multiple OMi servers, repeat the steps above for the rest of your OMi servers.

Step 4: Configure Launch of Service Manager Incident Details from OMi

If you want to be able to drill down to Service Manager incidents from the OMi Event Browser, you must configure the Service Manager web tier in the **sm:ServiceManagerAdapter** script in OMi.

1. Navigate to Connected Servers in OMi:

Administration > Setup and Maintenance > Connected Servers

Click  **Manage Scripts**.

2. Select the **sm:ServiceManagerAdapter** script, and click the **Edit Item** button.
3. Click the **Script** tab and locate the following text in the Groovy script:

```
private static final String SM_WEB_TIER_NAME = 'webtier-9.30'
```

4. Change the value of `webtier-9.30` to the value required to access the Service Manager web tier client.

The drill-down URL is made up like this:

```
http://<FQDN of Service Manager web tier server>/<web path to Service Manager>/<URL query parameters>
```

In this instance, `<FQDN of Service Manager web tier server>` is the fully qualified DNS name of the Service Manager server where the web tier client is installed. This part of the URL is added automatically (together with `http://` or `https://`) according to the values that you provided when you configured Service Manager as a target connected server in the Connected Servers manager. The address of the Event Drilldown section of the Connected Server makes up the rest of the URL. For details, see the previous step on connecting servers.

An example of a drill-down URL:

```
http://smserver.example.com/SM930/index.do?ctx=docEngine&file=probsummary&query=number%3D%22IM10216%22&queryHash=bf52f465
```

In this example, you must replace `webtier-9.30` with `SM930`. All the other parts of the URL are configured automatically.

5. When finished editing, save the new version of the script. Note that the script can always be reverted to its original version.

For details, see the *OMi Administration Guide*.

6. If you are using SM 9.34 or lower, set the values of the `querysecurity` parameter and the `querySecurity Web` parameter from the default values (`true`) to `false` in the SM web tier configuration file `web.xml`.

For details about the `querysecurity` parameter and the `querySecurity Web` parameter, see Service Manager Online Help.

(optional) Step 5: Attribute Synchronization

Attribute Synchronization Using Groovy Scripts

When the SM incident is initially created from an OMi event, event attributes are mapped to the corresponding SM incident attribute. Out of the box, after the initial incident creation, whenever the incident or event subsequently changes, only a subset of the changed event and incident attributes are synchronized. The following describes how to customize the list of attributes to synchronize upon change. If you want to change the out-of-the-box behavior regarding which attributes are updated, you can specify this in the Groovy script used on the OMi side for synchronization or incident creation. In the Groovy script, you can specify which fields are updated in SM, and which fields are updated in OMi. You can also specify custom attributes in the Groovy script.

Bidirectional Synchronization of Attributes

Individual OMi event attributes can be synchronized from an OMi event to the corresponding SM incident, whenever the event is changed in OMi. Similarly, individual SM incident attributes can be synchronized from an SM incident to the corresponding event in OMi, every time the event is changed in SM. To change the attributes that are synchronized from an OMi event to a corresponding SM incident, change the attributes included in the `SyncOPRPropertiesToSM` list in the Groovy script. To change the attributes that are synchronized from an SM incident to an OMi event, change the attributes

included in the `SyncSMPPropertiesToOPR` list in the Groovy script. By default, the `state`, `solution`, and `cause` attributes are synchronized from OMi events to their corresponding SM incidents, and the `incident_status` and `solution` attributes are synchronized from an SM incident to the corresponding OMi event.

To enable synchronization of all attributes in both directions, you can set the `SyncAllProperties` variable to `true`. In this case, all other variables will be ignored.

Example:

- `private static final Set SyncOPRPropertiesToSM = ["state", "solution", "cause"]`
- `private static final Set SyncSMPPropertiesToOPR = ["incident_status", "solution"]`

The following table lists the OMi event attributes that can be synchronized with an SM incident, and the matching SM incident attributes that can be synchronized with an OMi event:

OMi event attribute	SM incident attribute
title	name
description	description
state	incident_status
severity	urgency
priority	priority
solution	solution

Unidirectional Synchronization of Attributes

The `assigned_user`, `assigned_group`, and `cause` event properties can be synchronized from an OMi event to a corresponding SM incident. To synchronize these attributes, add them to the `SyncOPRPropertiesToSM` list in the groovy script.

Example:

- `private static final Set SyncOPRPropertiesToSM = ["assigned_user", "assigned_group", "cause"]`

Individual OMi event properties can be synchronized to a corresponding SM incident Activity Log. Updates are not synchronized back from the SM incident Activity Log to the corresponding OMi event. To change the properties that are synchronized, add the desired properties to the `SyncOPRPropertiesToSMActivityLog` list in the Groovy script. By default, the `title`, `description`,

state, severity, priority, annotation, duplicate_count, cause, symptom, assigned_user, and assigned_group properties are synchronized.

Example:

- `private static final Set SyncOPRPropertiesToSMActivityLog = ["title", "description", "priority"]`

The following list includes all properties that can be synchronized from OMi events to the SM incident Activity Log:

- title
- description
- state
- severity
- priority
- solution
- annotation
- duplicate_count
- assigned_user
- assigned_group
- cause
- symptom
- control_transferred_to
- time_state_changed

Custom Mappings for Custom Attributes

You can define your own mappings for custom attributes between OMi and SM. These mappings can be either unidirectional, if the attributes are only contained in one map, or bidirectional, if the attributes are contained in both maps. To create custom mappings for custom attributes, you can edit the `MapSM2OPRCustomAttribute` and `MapOPR2SMCustomAttribute` lists in the Groovy script. These maps are empty by default.

Example:

- `private static final Map <String, String> MapSM2OPRCustomAttribute =
["MySMAttribute" : "MyOMiCustomAttribute"]`
- `private static final Map <String, String> MapOPR2SMCustomAttribute = [
"MyOtherOMiCustomAttribute" : "MyOtherSMAttribute", "MyThirdOMiCA", "activity_
log"]`

Mapping OPR Lifecycle States to BDM Lifecycle States

Individual OPR event state and SM incident status changes may be selected for synchronization. Out of the box, only the "closed" state is synchronized in both directions. To change this behavior, add the desired states to the appropriate list, `SyncOPRStatesToSM` or `SyncSMStatusToOPR`.

Examples:

- `private static final Set SyncOPRStatesToSM = ["closed", "in_progress",
"resolved"]`
- `private static final Set SyncSMStatusToOPR = ["closed", "resolved"]`

In the example, the OPR event lifecycle states `closed`, `in_progress`, and `resolved` are synchronized to the SM incident status, and SM incident statuses `closed` and `resolved` are synchronized to the OPR event state.

Note: The special state "*" denotes all states, so to synchronize all OPR event states to the SM incident status property, specify the following:

```
private static final Set SyncOPRStatesToSM = ["*"]
```

Additionally, two maps are used to specify the mapping of the OPR event lifecycle state to the BDM incident status. The maps are named `MapOPR2SMStatus` and `MapSM2OPRState`. Out of the box, all possible states have a mapping.

Examples:

- `private static final Map MapOPR2SMStatus = ["open": "open", "in_progress":
"work-in-progress", "resolved": "resolved", "closed": "closed"]`
- `private static final Map MapSM2OPRState = ["accepted": "open", "assigned":
"open", "open": "open", "reopened": "open",
"pending-change": "in_progress", "pending-customer": "in_progress", "pending-
other": "in_progress",`

```
"pending-vendor": "in_progress", "referred": "in_progress", "suspended": "in_
progress",
"work-in-progress": "in_progress", "rejected": "resolved", "replaced-problem":
"resolved",
"resolved": "resolved", "cancelled": "resolved", "closed": "closed"]
```

Tips for customizing Groovy Scripts

This section provides some tips about customizing Groovy scripts. It contains a few selected examples of what you can customize. To see further items that can be modified, see the configuration section of a Groovy script.

In the configuration section of the Groovy script, you can define and modify the attributes that are to be synchronized between OMi and SM. The configuration section of the Groovy script also contains the default value mappings for lifecycle state, severity, and priority. You can also modify these, and it is possible to define the mappings for in-going and out-going requests differently.

More advanced configuration can be done in other parts of the Groovy script if required.

The beginning and the end of the configuration section of the Groovy script is marked as follows:

```
//
// *BEGIN Configuration: Customization of properties for synchronization*
//
...
...
//
// *END Configuration: Customization of properties for synchronization*
//
```

Note: Modifications to Groovy scripts are not overwritten by patches and hotfixes. Your customized version of a script will remain after an update or a patch. If you want to use the newer version of a script, make a copy of your version, revert back to the predefined version, and then reapply your changes.

The mapping from OMi to SM is compliant to BDM 1.1 incident web service specifications. The mapping of the BDM 1.1 incident web service to SM is specified in SM in the BDM Mapping Manager. For more information about the BDM Mapping Manager, see Service Manager Online Help.

Avoiding Errors with Large TQL Queries

If the Groovy script executes a TQL query that produces a large number of results, an error message appears informing you about the TQL query result exceeding the size limit. As a consequence, the integration event is not sent. It is possible, however, to increase this limit by modifying the value of the `tql.compound.link.max.visited.objects` setting.

Note: To check the default value of the `tql.compound.link.max.visited.objects` setting, from the JMX console, select **UCMDB:service=Settings Services**, and then locate the **showSettingsByCategory** method and enter **TQL Settings** as the category name.

To modify the value of the `tql.compound.link.max.visited.objects` setting, follow these steps:

1. From the JMX console, select **UCMDB:service=Settings Services**.
2. Click **setSettingValue**.
3. Enter `tql.compound.link.max.visited.objects` as the name of the setting you want to modify and a new value for it.

Caution: Increasing the value of the `tql.compound.link.max.visited.objects` setting also increases the load on the RTSM. Therefore, make sure to carefully consider how much to increase this value.

Syntax Errors

The `ServiceManagerAdapter` Groovy script uses the Apache Wink client to communicate with Service Manager. It therefore will throw a `ClientWebException` when there is an HTTP error status returned by Service Manager.

If you get a syntax error when customizing your Groovy scripts, you will get an event in the event browser with a detailed description of the error. In addition, you may view the `opr-event-sync-adapter.log` log file for information about how to resolve the error. You can find this log file at the following location:

`<Gateway Server root directory>/log/opr-scripting-host/opr-event-sync-adapter.log`

Step 6: Test the Event Forwarding and Cross Launches

To test the event forwarding, forward an event manually to SM and then verify that the event is forwarded to SM as expected, and that the cross launches work in both directions.

1. Open an OMi **Event Browser**.
2. Select an event and select **Transfer Control To** in the Context Menu. Select the SM target system.
3. Select the **Forwarding** tab.
4. In the External Id field, you should see a valid SM incident ID after a few seconds.
5. Verify that the incident appears in the Incident Details in Service Manager by using the cross launch (see next step).

If the event drill-down connection is not configured, verify the forwarding by using the following:

- a. In the Forwarding tab in the OMi Event Browser, copy or note the incident ID from the External Id field.
 - b. In the Service Manager user interface, navigate to:
Incident Management > Search Incidents
 - c. Paste or enter the incident ID in the Incident Id field.
 - d. Click the **Search** button. This takes you to the incident in the Incident Details.
6. Test the cross launch from OMi to SM:

Click the hyperlink created with the incident ID. A browser window opens, which takes you directly to the incident in the Incident Details in Service Manager.

7. Test the cross launch from SM to OMi:

In the Incident Details in Service Manager, click **More** and then select **View OMi Event**. A browser window opens, which takes you directly to the event in the Event Browser in OMi.

Note: The **View OMi Event** option displays only when the **omi.mgr.id** parameter in the corresponding SM-OMi integration instance is set correctly.

8. Close the incident in Service Manager.
9. Verify that the change in the state of the incident (it is now `closed`) is synchronized back to OMi. You may not be able to see the event that was closed in SM in the active Event Browser, but it should now be in the Closed Events Browser.

Advanced Configuration

Configure forwarding of affected business services from OMi to SM

Service Manager versions 9.40 and higher support the display of multiple affected business services associated with an event in OMi. By default, when an event is created in OMi that affects more than one business service CI, all affected services are automatically forwarded to SM. The most critical service is displayed on the "Primary Service" tab in SM, and all other affected services are displayed on the "Impacted Services" tab.

If you only want to forward the most critical affected service associated with an event from OMi to SM, you can change the `ForwardAllAffectedBusinessServices` flag in the **sm:ServiceManagerAdapter** script to false.

1. Navigate to **Connected Servers** in OMi:

Administration > Setup and Maintenance > Connected Servers

Click  **Manage Scripts**.

2. Select the **sm:ServiceManagerAdapter** script, and click the **Edit Item** button.
3. Click the **Script** tab and search for `ForwardAllAffectedBusinessServices`. Change the value to false.
4. When finished editing, save the new version of the script. Note that the script can always be reverted to its original version. For details, see the *OMi Administration Guide*.

Configure automatic closure for OMi incidents in SM

Incidents created from OMi events will be automatically closed when the corresponding OMi event is closed. You can also configure SM incidents created from OMi events to be automatically closed after a predefined amount of time since they were last updated (or resolved if they have not been updated after being resolved).

The workflow is as follows:

1. An incident is opened from OMi.
2. If the **Schedule Condition** is met, the system creates a schedule record for the incident. The schedule record will expire at a future time based on the **Calc Expression**.

3. A user updates the incident and saves the changes.
4. The **Reset alerts if** expression on the **Alerts** tab of the **probsummary** object definition is evaluated. If it evaluates to true, the Expiration time of the schedule record is updated based on the Calc Expression. By default, the expiration time of the schedule record is updated only when the incident has a category of **incident**.
5. When the schedule record expires, the **Alert Condition** is evaluated. If it evaluates to true, the incident is automatically closed.

To enable automatic closure for OMi incidents:

1. Configure the global settings in the Incident Management Environment record.
 - a. In SM versions lower than 9.40, click **System Administration > Ongoing Maintenance > Environment Records > Incident Management Environment**.

In SM versions 9.40 and higher, click **Incident Management > Administration > Environment**.
 - b. Change the following settings as necessary.

Field	Value
Close Incident Automatically?	This option disables or enables the automatic closure of OMi incidents at the global level. <ul style="list-style-type: none"> • If this option is not selected, no incidents will be automatically closed. • If this option is selected, incidents will be automatically closed under specified conditions. Default: Not selected
Closure Code	This value will be copied to the Closure Code field of incidents when they are automatically closed. Default: Automatically Closed
Solution	This description will be appended to the end of the Solution field of incidents when they are automatically closed. Default: This incident which belongs to OMi has been closed automatically.

- c. Click **Save**.
- d. Restart the Service Manager server.

Note: If you have made any changes to any of the configuration options in the Incident Management Environment record, the Service Manager server must be restarted for the changes to take effect.

2. Configure the alert definition that determines when an incident should be closed.

Note: The **alert** and **problem** processes must be running to enable the successful closure of OMi incidents.

- a. Click **Tailoring > Document Engine > Alerts**.
- b. In the Alert Name field, enter: **OMI Auto-Close**.
- c. Click **Search**. The OMiAuto-Close alert definition detail form opens.

Caution: These fields in the alert definition are used to control automatic closure of OMi incidents. You can change the default values of these fields. However, you must be aware of the risk that automatic closure of OMi incidents will not work properly if the **Schedule Condition** and **Alert Condition** fields are not configured correctly.

Field	Value
Schedule Condition	<p>This expression is used to determine if an incident should be scheduled for automatic closure. Default: <code>jscall("SMOMi.isAutoCloseAndResolved")</code>.</p> <p>An incident is scheduled for automatic closure when the following conditions are met.</p> <ul style="list-style-type: none"> • The Close Incident Automatically? option in the Incident Management Environment record is selected. • In the incident record, the Do not close this incident automatically option is not selected. • The incident has a status of Resolved.
Alert Condition	<p>This expression is evaluated when an incident is about to be automatically closed. If it evaluates to true, the incident is closed. Default: <code>jscall("SMOMi.isAutoCloseEnabled")</code>.</p> <p>An incident is closed when the following conditions are met.</p> <ul style="list-style-type: none"> • The Close Incident Automatically? option in the Incident Management Environment record is selected. • In the incident record, the Do not close this incident automatically option is not selected.
Calc Expression	<p>This expression is used to determine how much time will elapse before an incident is automatically closed. Default: <code>\$L.alert.time=update.time in \$L.file+'7 00:00:00'</code>.</p> <p>The default value means the amount of time elapsed is equal to seven days since the incident was last updated.</p>

3. Configure alert information in the **probsummary** object.

The OMi autoclose alert definition is configured to only be used by OMi incidents. The closure time is reset each time the incident is updated. If the closure time is reached without the incident being updated then Service Manager will automatically close the incident.

- a. Click **Tailoring > Document Engine > Objects**.
- b. In the **File name** field, enter **probsummary** and press ENTER. The **probsummary** object definition is displayed.
- c. Select the **Alerts** tab.

The **Reset alerts if** expression is used to reset the automatic closure time of OMi incidents.

Default: `category in $L.file="incident" and not null(1 in external.process.reference in $L.file)`.

Configure TLS for the Incident Exchange integration

When OMi is configured to accept https connections only, you must configure TLS for the integration. If you do not do so, changes on an incident that is created from OMi cannot be synchronized back to OMi.

Note: The following steps describe how you do so by using the built-in keytool in Service Manager, and the file paths are for Windows only. Be sure to change the file paths accordingly if your Service Manager system is running on Unix.

To configure TLS for the integration, follow these steps:

1. Import the OMi root certificate to the Service Manager server trusted keystore.

The following is an example of the command line:

```
<SM Install path>\server\RUN\jre\bin\keytool -import -alias myCA -file <.pem
file of your BSM root certificate> -keystore <SM Install
path>\Server\RUN\jre\lib\security\cacerts -storepass <changeit>
```

Note: Where: *changeit* is the default password of the trusted keystore. Change it to your own password if you have changed it.

2. Add the following parameters to the Service Manager server configuration file (<SM install path>\Server\RUN\sm.ini):

```
truststoreFile:<SM install path>\Server\RUN\jre\lib\security\cacerts
```

```
truststorePass:<changeit>
```

3. Restart the Service Manager Server service.

Downtime Forwarding from Service Manager to OMi (RTSM)

You can create downtimes (also known as outages) in OMi based on Requests for Changes (RFCs) in SM. This is done in two steps. First, scheduled downtime CIs are created in OMi based on RFCs in SM. Then, a BSM downtime CI is created based on the scheduled downtime.

You can also send downtime start and end information from OMi to SM to notify operators of when a downtime occurs, especially if the downtime was not driven by an RFC in SM. For more information on this integration, see ["Sending downtime notifications from OMi to SM \(RTSM\)" on page 140](#)

Notes:

1. For Changes/Tasks that have final approval phases defined in Service Manager Integration Suite (SMIS), the downtimes will be synchronized after the Changes/Tasks get final approval.
2. Only downtimes that end at a future time will be synchronized.
3. Select the **Configuration Item(s) Down** checkbox when scheduling downtimes in Changes/Tasks.
4. The SLA scheduler needs to be started in the **System Status** form.

Step 1: Add an SMBSM_DOWNTIME integration instance in SM

To set up the integration from Service Manager to OMi, you must add an instance of this integration in the Service Manager Integration Suite (SMIS). Note that additional setup is required on the OMi side for integration from OMi to Service Manager.

To add the SMBSM_DOWNTIME instance:

1. Click **Tailoring > Integration Manager**. Integration Instance Manager opens.
2. Click **Add**. The Integration Template Selection wizard opens.
3. Select **SMBSM_DOWNTIME** from the Integration Template list. Ignore the **Import Mapping** check box, which has no effect on this integration.
4. Click **Next**. The Integration Instance Information page opens.
5. Do the following:
 - Modify the **Name** and **Version** fields to the exact values you need.
 - In the **Interval Time(s)** field, enter a value based on your business needs in regard to downtime exchange frequency. Note that a short interval time can be safe because the next scheduled task will not start until the previous task is completed and the interval time passed.
 - In the **Max Retry Times** field, enter a value. This is the maximum allowed number of retries (for example, 10) for each failed task.
 - In the **Log File Directory** field, specify a directory where log files of the integration will be stored. This must be a directory that already exists on the Service Manager server. By default, logging message is output to `sm.log`.
 - (Optional) In the **SM Server** field, specify a display name for the Service Manager server host. For example: `my_local_SM`.
 - (Optional) In the **Endpoint Server** field, specify a display name for the OMi server host. For example: `my_BSM_1`.
 - (Optional) In the **Log Level** field, change the log level from INFO (default) to another level. For example: WARNING.
 - (Optional) If you want this integration instance to be automatically enabled when the Service Manager Server service is started, select **Run at system startup**.
6. Click **Next**. The Integration Instance Parameters page opens.
7. On the **General Parameters** tab, complete the following fields as necessary:

Name	Category	Value	Description
WithdrawDowntime	General	true/false	<p>Set this value to <code>true</code>: When authorized users are manually changing the phase of a change record which has 'valid' outage, a window will open and provide choices of withdrawing the outage.</p> <p>Set this value to <code>false</code>: The pop-up window is disabled. This operation may cause some</p>

Name	Category	Value	Description
			unapproved planned downtimes be synchronized to OMi. By default, this value is set to true.
Category or workflow (Process Designer) name of changes	Change	The final approval phase for changes	Set the final approval phase for downtime, which is the indication of valid downtime information.
Category or workflow (Process Designer) name of tasks	Task	The final approval phase for tasks	Set the final approval phase for downtime, which is the indication of valid downtime information.
sm.host	General	<sm server name >	Set the Service Manager server host name or DNS name to compose the External Process Reference and the Reference Number of Scheduled Downtime CI in UCMDB. Note: Do not include a colon in this field. Otherwise, the logic will be broken.
sm.reference.prefix	General	urn:x-hp:2009:sm	Set the prefix to compose the External Process Reference of Scheduled Downtime CI in UCMDB. Note: This field has a fixed value. Do not change it.

Notes:

- Type category or workflow name of change/task in the **Name** column. This value is case-sensitive and it must match the record in Service Manager database.
- Set the value to Change for changes in the **Category** column. Similarly, set the value to Task for tasks.
- Type the final approval phase in the **Value** column. This value is case-sensitive and it must match the record in Service Manager database. You can separate multiple phases by semicolons, which must be the English character.
- Detailed information will be displayed in the integration log when the following errors occur:

- User input of categories/phases for the changes/tasks is not correct.
 - The category and phase pair does not exist in the database.
- e. For Change Management categories which do not have approval phase, the downtime integration will treat its downtime information as final approved once created. You do not need to define any phases in SMIS parameters.
- f. For the category or workflow name of the changes and the tasks, the integration will ignore all the final phases defined for the redundant category or workflow.
8. Click **Next** twice and then click **Finish**. Leave the Integration Instance Mapping and Integration Instance Fields settings blank. This integration does not use these settings.
- Service Manager creates the instance. You can edit, enable, disable, or delete it in Integration Manager.
9. Enable the integration instance. SMIS will validate all the final phases you filled in the Integration Instance Parameters page and print warning messages if there are errors.

Step 2: Tailor Service Manager to handle phase change

In the Service Manager Change Management module, authorized users can manually change the phase of a change record. If the phase is changed to the one prior to the final approval phase in the SMBSM_DOWNTIME instance, the system will check if there are existing planned downtimes that have been set to Ready. If such downtimes exist, a window will open and provide two options for the corresponding planned downtimes:

- Click **Yes** to withdraw the corresponding planned downtimes from the RTSM. The changes or tasks need to be approved again to synchronize with the RTSM at another time.
- Click **No**. There will be no change to the planned downtimes even if the actual status of the changes or tasks are not approved.

Note: To disable the pop-up window when withdrawing the planned downtimes, you must set the `WithdrawDowntime` parameter to `false` in the SMBSM_DOWNTIME instance. This operation may cause some unapproved planned downtimes to be synchronized to OMi.

With Process Designer (PD) Content Pack 2 applied in Service Manager, you can tailor the process to transit changes or tasks from one phase that is after the final approval phase in the SMBSM_DOWNTIME instance to another that is prior to the final approval phase. To withdraw the related

planned downtime for this kind of transition, you must add a rule set for the transition in the Closed Loop Incident Process (CLIP) solution. Follow these steps:

1. Go to the target workflow that needs tailoring.
2. Select the transition that moves a phase from before the final approval phase to after the final approval phase.
3. In the Rule Sets section, click **Add** and select the **clip.downtime.withdraw** rule set.
4. Click **OK** to save the workflow.

Step 3: Set up downtime sync jobs in OMi

As part of CI synchronization, you have already set up an integration point between SM and OMi. In this step, you add downtime synchronization jobs, so that scheduled downtime CIs are created in OMi based on Requests for Change in SM.

To add the downtime synchronization jobs:

1. Log in to your OMi system as an administrator.
2. Edit the existing integration point that connects to your Service Manager server.
3. Click **Administration > RTSM Administration > Data Flow Management > Integration Studio**. OMi displays a list of integration points.
4. Select the existing SM integration point. Make sure that CIs have already been synchronized between SM and OMi.
5. Create two integration jobs in the integration point on the **Population** tab:
 - a. Create a new job including the SM **CLIP Down Time Population** job definition. Under **Scheduler Definition**, select the **Scheduler enabled** checkbox and set the Repeat Interval to 1 Minute. Click **OK** to save the job.
 - b. Create another new job including the SM **CI Connection Downtime CI** job definition. Under **Scheduler Definition**, select the **Scheduler enabled** checkbox and set the Repeat Interval to 1 Minute. Click **OK** to save the job.

Pay attention to the running order. The **CLIP Down Time Population** job must be run first. You can set the two jobs as schedule-based and set the schedule interval according to your needs.

Note: If no related CIs exist in RTSM when creating relationships, the population will fail or succeed with a warning. To disable the warning, remove the downtime CI that does not have related CIs in RTSM.

Step 4: Set up creation of BSM Downtime CIs

In this step, BSM Downtime CIs are created based on Scheduled Downtime CIs.

Important:

- Following the initial integration, a large amount of data may be communicated from SM to OMi. It is highly recommended that you perform this procedure during off-hours, to prevent negative impact on system performance.

To create BSM Downtime CIs:

1. Create a new Integration Point or, if existing, edit the **SM Scheduled Downtime Integration Into BSM** Integration Point:

- a. Do the following on your OMi system.

Go to:

Administration > RTSM Administration > Data Flow Management > Integration Studio

- b. Click **New Integration Point** or **Edit**, enter a name and description of your choice, and select the adapter **SM Scheduled Downtime Integration Into BSM** from the Service Manager folder.

If you have upgraded from an older version of OMi to OMi 10.10, you may still see the old "BSM Downtime Adapter", or you may see the "SM Scheduled Downtime Integration Into BSM" adapter in the Third Party Products folder (not in the Service Manager folder). In this case, you must upgrade your adapter by doing the following:

- i. Open the Package Manager.
- ii. Deploy the package: `/opt/hp/BSM/odb/conf/factory_packages/BSMDowntimeAdapter.zip` on the data processing server.
- iii. You should now find the **SM Scheduled Downtime Integration Into BSM** adapter in the Service Manager folder.
- c. Enter the following information for the adapter: OMi GW or Load Balancer/Reverse Proxy FDQN and port (80/443), communication protocol (http/https), and the context root (if you have a non-default context root).
- d. Specify the credentials for the OMi system. The specified user must have administrative

rights in the RTSM. Choose generic protocol as protocol.

- e. Click **OK**, then click the **Save** button above the list of the integration points.
2. You can use the **Statistics** tab in the lower pane to track the number of downtimes that are created or updated. By default, the integration job runs every minute. If a job has failed, you can open the **Query Status** tab and double-click the failed job to see more details on the error.

If there is an authentication error, verify the OMi credentials entered for the integration point.

If you receive an unclear error message with error code, this generally indicates a communication problem. Check the communication with OMi.

A failed job will be repeated until the problem is fixed.

Step 5: Verify the SM-OMi downtime synchronization setup

When you have set up the Downtime integration, you can perform the following tasks to see if you have successfully set up your downtime synchronization.

Task 1. Open a new change of a category that has the final approval phase defined in SMIS

1. Click **Change Management > Create New Change**.
2. Select **Hardware** for example.
3. In the Affected CI field, choose a CI that has been synchronized. For example: adv-afr-desk-101.
4. Set Scheduled Downtime Start and Scheduled Downtime End to a future time.
5. Select the **Configuration Item(s) Down** checkbox.
6. Set other required fields.
7. Click **Validation Accepted**. If you are prompted to fill in more required fields, supply the required information and click Validation Accepted again.
8. Click **Request Authorization**.
9. Click **Save&Exit** the change.

Task 2. Approve the change at the final approval phase

1. Click **Change Management > Task Queue**.
2. Search for the task that was created in Task 1 and click **Close** to close the task.
3. Click **Change Management > Search Change** and search for the change opened in Task 1.
4. Move the Change to the Change Approval phase by selecting **Request Authorization**.
5. Log on to Service Manager with user account `Change.Approver`.
6. Select **Approval Inbox** and search for the change created in Task 1.
7. Approve the change.

Task 3. Create new format for the intClipDownTime table

1. Open the SM Windows client.

Note: This step can only be performed in the SM Windows client.

2. Enter **fd** into the search field to open the Forms Designer and click **New**.
3. Create a new format for the intClipDownTime table by using the Form Wizard.
4. Add all fields to this format.

Task 4. Check the corresponding intClipDownTime record

1. From Database Manager, open the format of the intClipDownTime table.
2. Click **Search** to see the record created for this downtime.
3. Check the External Status field:

External Status values	Description
NULL	The downtime is waiting for final approval, or the scheduler has not proceeded this record yet.

External Status values	Description
0 (Canceled)	The downtime is canceled before being implemented.
1 (Ready)	The downtime has been approved and is ready to be synchronized to UCMDB or BSM (RTSM).
2 (Withdrawn)	The downtime is approved firstly and then the approval is retracted (withdrawn).

Notes:

- a. Only downtime records with External Status 1 can be synchronized.
- b. If the External Status is not 1, wait some time for background schedulers SLA and SMBSM_DOWNTIME to process this record.

Task 5. Populate downtime from Service Manager to UCMDB

1. From UCMDB, run the CLIP Down Time Population job and the CI To Down Time CI With Connection job in a fixed order.
2. Search for the adv-afr-desk-101 CI in UCMDB. Check that a corresponding Scheduled Downtime CI is created, and a relationship between the Scheduled Downtime CI and the affected CI is created.

Task 6. Test if BSM Downtime CIs have been created

1. In OMi, go to **Administration > Service Health > Downtime Management**.
2. Check if a corresponding Downtime was created.

Sending downtime notifications from OMi to SM (RTSM)

OMi can send downtime start and end events to SM to notify operators of when a downtime occurs. This provides additional information to the SM operator in case of a downtime that was not driven by an RFC.

To create downtimes in OMi based on RFCs in SM, see ["Downtime Forwarding from Service Manager to OMi \(RTSM\)" on page 131](#).

Step 1: Send OMi Downtime Events to SM

To enable OMi to send downtime start and end events to SM, follow these steps:

1. Access the following location in OMi:
Administration > Setup and Maintenance > Infrastructure Settings > Foundations > Downtime
2. Change the value of the **Downtime Send Event** parameter to **true**.
3. Restart your OMi services on all Gateway Servers and Data Processing Servers.

This procedure generates events in OMi. After performing it, make sure you edit and enable the **Automatically forward "downtime started" and "downtime ended" events to Trouble Ticket System** event forwarding rule to forward downtime-start and downtime-end events to the SM server that should be specified in the alias connected server called "Trouble Ticket System". For details on event forwarding and connected servers, see the *OMi Administration Guide*.

Downtime events use the following formats:

- **Downtime Start**

Event field	OMi Downtime
Severity	Normal
Category	Downtime Notification
Title	Downtime for <CI Type><Affected CI Name>started at <Downtime Start Time>

Event field	OMi Downtime
Key	<OMi Downtime ID>:<Affected CI ID>:downtime-start
SubmitCloseKey	False
OutageStartTime	<Downtime Start Time>
OutageEndTime	<Downtime End Time>
CiName	<Affected CI Name>
CiId	<Affected CI Global ID>
CiHint	GUCMDB:<Affected CI Global ID> UCMDB:<Affected CI ID>
HostHint	GUCMDB:<Related Host Global ID> UCMDB:<Related Host ID>
EtiHint	downtime:start

- **Downtime End**

Event field	OMi Downtime
Severity	Normal
Category	Downtime Notification
Title	Downtime for <CI Type><Affected CI Name> ended at < Downtime End Time>
Key	<OMi Downtime ID>:<Affected CI ID>:downtime-stop
SubmitCloseKey	true
CloseKeyPattern	<OMi Downtime ID>:<Affected CI ID>:downtime-start
EtiHint	downtime:end
LogOnly	true

View Changes and Incidents in OMi (RTSM)

This integration enables you to view planned changes and incident details in the Changes and Incidents and Hierarchy components in OMi.

This chapter includes the following:

- ["Prerequisite" below](#)
- ["Step 1: Configure the Service Manager Adapter Time Zone" below](#)
- ["Step 2: Create an Integration Point in OMi" on the next page](#)
- ["Step 3: Edit Integration TQLs " on page 144](#)
- ["Step 4: Verify View changes and incidents" on page 145](#)
- ["How to Customize the Changes and Incidents Component" on page 145](#)

Prerequisite

This integration requires that CIs are synchronized between the RTSM and SM. For information on CI synchronization, see ["Operations Manager i - Service Manager Integration Overview" on page 93](#).

This integration requires an administrator user account for OMi to connect to SM. This user account must already exist in both OMi and SM. For details on creating required user accounts, see ["Create User Accounts for the OMi-SM Integration \(RTSM\)" on page 98](#)

Step 1: Configure the Service Manager Adapter Time Zone

Configure the time zone so Incidents and Planned Changes have the correct time definitions:

1. In SM, select **Navigation pane > Menu navigation > System Administration > Base System Configuration > Miscellaneous > System Information Record**. Open the **Data Info** tab.
2. In the **Date Info** tab, look up the value for the Time Zone.
3. In OMi, select **Administration > RTSM Administration > Data Flow Management > Adapter Management**.
4. In the **Resources** window, open **ServiceManagerAdapter9-x > Configuration Files > ServiceManagerAdapter9-x/serviceDeskConfiguration.xml**

Find the row that includes the following string:

```
<globalConnectorConfig><![CDATA[<global_configuration><date_pattern>MM/dd/yy  
HH:mm:ss</date_pattern><time_zone>US/MOUNTAIN</time_zone>
```

Check the date and time format, as well as a time zone. Note that the date is case-sensitive. Change either SM or the `xml` file so that they both match each other's settings.

Note: Specify a time zone from the Java time zone list that matches the time zone used in SM (for example, America/New York).

5. If you changed the time zone on SM, restart the SM server; if you changed the time zone on OMi, you do not need to restart the OMi server.)

Step 2: Create an Integration Point in OMi

To create an integration point, follow these steps:

1. In OMi, select **Administration > RTSM Administration > Data Flow Management > Integration Studio**.
2. In the Integration Point pane, select **Create New Integration Point** or choose an existing integration point to edit. The Create New Integration Point dialog box opens. Enter the following:

Name	Recommended Value	Description
Integration Name	SM Integration	The name you give to the integration point.
Adapter	<user defined>	Select Software Products > Service Manager > Service Manager 9.xx . This adapter, which supports CI/ relationship Data Push from RTSM to Service Manager, and Population and Federation from Service Manager to RTSM.
Is Integration Activated	selected	Select this check box to create an active integration point.
Hostname/IP	<user defined>	The name of the SM server.
Port	<user defined>	The port through which you access SM.
Credentials ID	<user defined>	Click Generic Protocol , click the Add button to add the integration user account you created in " Create User Accounts for the OMi-SM Integration (RTSM) " on page 98 and then select it.

Name	Recommended Value	Description
Probe Name (for ServiceManagerAdapter9-x only)	<user defined>	Select the probe that you installed for this integration.

Note: It is recommended to click the **Test Connection** button to verify that the details entered are working before continuing.

- In the **Integration Point** pane, click the Integration Point you just created, and click the **Federation** tab in the right pane.
- In the **Supported and Selected CI Types** area, verify that **Incident** and **RequestForChange** are selected.

Step 3: Edit Integration TQLs

In this step, edit the integration TQLs so that they use the Integration Point created in the previous step.

- In OMi, select **Administration > RTSM Administration > Modeling > Modeling Studio**.
- On the **Resources** tab, select Resource Type: Queries. Open the **Console** folder.
- Open the TQL: `CollectRequestForChangeWithImpacts`.
- In the **Query Definition** pane, right click one of the objects of CI Type: `RequestForChange`.
- From its Context Menu, select **Set Integration Points**. Choose the Integration Point that you configured in the previous step.
- Repeat steps 4 and 5 for all objects of CI Type: `RequestForChange`.
- Open the TQL: `CollectRequestForChangeWithoutImpacts`.
- Repeat steps 4 and 5 for all objects of CI Type: `RequestForChange`.
- Open the TQL: `CollectTicketsWithImpacts`.
- In the **Query Definition** pane, right click one of the objects of CI Type: `Incident`.
- From its Context Menu, select **Set Integration Points**. Choose the Integration Point that you configured in the previous step.
- Repeat steps 10 and 11 for all objects of CI Type: `Incident`.
- Open the TQL: `CollectTicketsWithoutImpacts`.

14. Repeat steps 10 and 11 for all objects of CI Type: Incident.
15. Save all TQLs.

Step 4: Verify View changes and incidents

To verify that you can view changes and incidents in OMi, make sure that you have an incident in SM that is related to a CI in the OMi RTSM. To do so, send a test event related to a CI that has been synchronized between OMi and SM.

1. Send an event, for example, by using the following command:

```
submitEvent -t testViewIncidents -rch <hintForExistingCI>
```
2. Select the event in the OMi Event Browser and select **Transfer Control To** in the Context Menu. Select the SM target system.
3. Open the 360° View and select a view containing the related CI.
4. Select the CI, and verify that the **Incident Count** is at least 1. Click **Incidents** to show the Changes in Incidents window, and verify that the incident is displayed in the Incidents section.

By default, the Changes and Incidents component displays data for the previous week. You can change this setting to previous week, day, or hour (up to the current time) by using the Configure Component button.

How to Customize the Changes and Incidents Component

By default, incidents and requests for change are displayed for the following CI types: Business Service, Siebel Application, Business Application, and Node. If you want to view change and incident information for other CITs, perform the following procedure:

1. Open the Modeling Studio:

Administration > RTSM Administration > Modeling > Modeling Studio

Copy one of the TQLs within the **Console** folder, and save your copy with a new name. These default TQLs perform the following:

TQL name	Description
CollectTicketsWithImpacts	Retrieves SM incidents for the selected CI, and for its child CIs which have an Impact relationship.
CollectTicketsWithoutImpacts	Retrieves SM incidents for the selected CI.
CollectRequestForChangeWithImpacts	Retrieves SM requests for change, for the selected CI, and for its child CIs which have an Impact relationship.
CollectRequestForChangeWithoutImpacts	Retrieves SM requests for change, for the selected CI.

2. Edit the new TQL as needed. You can add CITs as described in "[Naming Constraints for New Request for Change TQLs](#)" below.

3. Open Infrastructure Settings:

Administration > Setup and Maintenance > Infrastructure Settings

- a. Select **Applications**.
- b. Select **Service Health Application**.
- c. In the **Service Health Application - Hierarchy (360) properties** area, enter the name of the new TQL you created in the corresponding infrastructure setting.

Note: By default, these infrastructure settings contain the default TQL names. If you enter a TQL name that does not exist, the default value will be used instead.

After you modify the infrastructure setting, the new TQL will be used, and the Changes and Incidents component will show this information for the CITs you defined.

Naming Constraints for New Request for Change TQLs

The following naming constraints must be followed in the request for change *without* impact TQL (see the TQL example below, on the right side of the image):

- The request for change CI type must start with **directPlannedChange**.
- The CI type related to the request for change must start with **trigger**.

The following naming constraints must be followed in the request for change *with* impact TQL (see the TQL example below, on the left side of the image):

- **impacterPlannedChange** represents the request for change CI type.
- The CI type related to the request for change must start with **impacter**.
- **triggerTUUniverse** represents the "impacted" child CIs.

Examples of request for change TQLs:

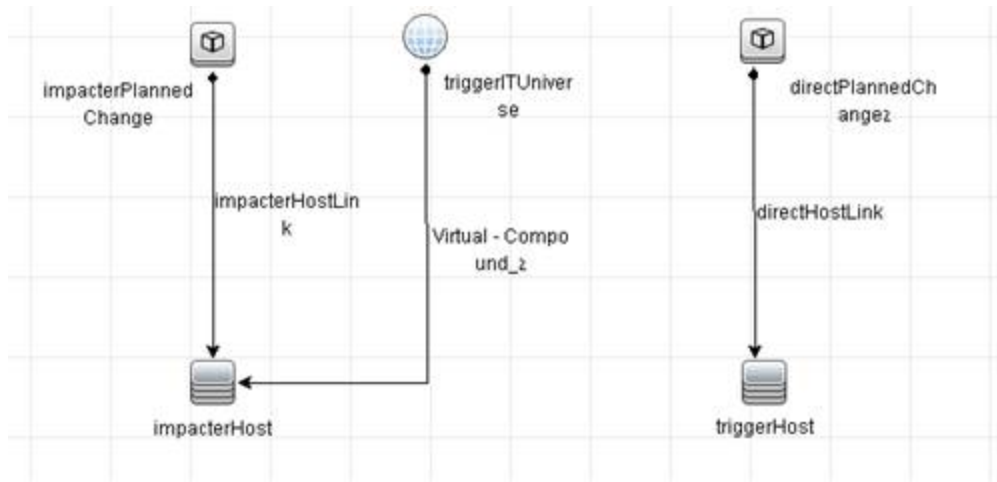

Naming Constraints for New Incident TQLs

The following naming constraints must be followed in the incidents *without* impact TQL (see the TQL example below, on the right side of the image):

- The incident CI type must start with **directTIncident**.
- The CI type related to the incident must start with **trigger**.

The following naming constraints must be followed in the incidents *with* impact TQL (see the TQL example below, on the left side of the image):

- **impacterTIncident** represents the incident CI type.
- The CI type related to the incident must start with **impacter**.
- **triggerTUUniverse** represents the "impacted" child CIs.

Examples of incident TQLs:

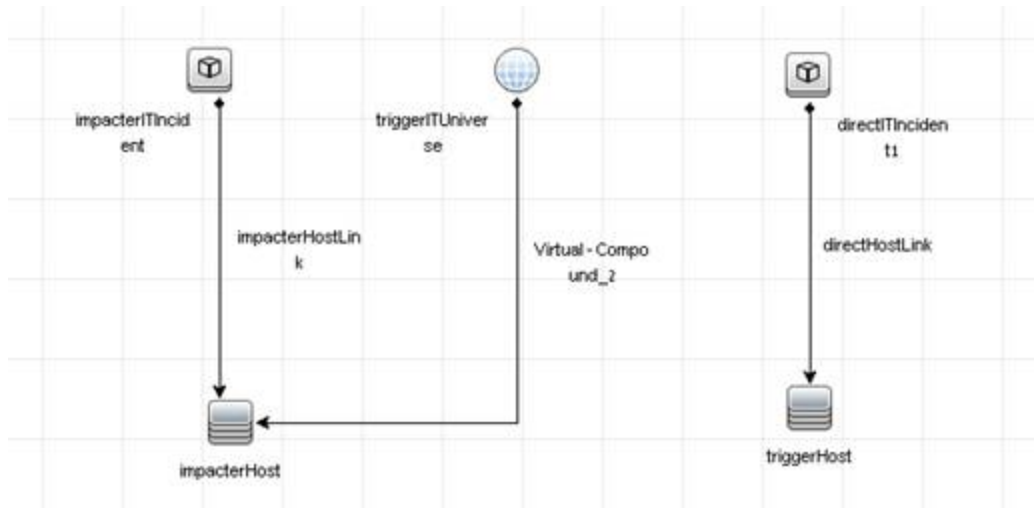

Business Impact Report (BIR) (RTSM)

OMi includes a report that you can use to help evaluate the impact of incidents on your business. For example, if a host CI has critical status, you can use the report to display the status of the Business Service CIs to which the host CI is attached.

Incident Management users can launch an impact report from an incident in context with the incident's affected configuration item (CI). Service Desk Agents can validate the updated status of the business impact to categorize and prioritize the incident accordingly.

Note:

- This integration requires that CIs are synchronized between both Service Manager and OMi.
- Only one instance of this integration is allowed.

Step 1: Add a Business Impact Report Integration in SM

To use the Service Manager to BIR integration, you must add and enable an instance of this integration in Integration Manager.

To add and enable a Service Manager to BIR integration instance:

1. Click **Tailoring > Integration Manager**. Integration Instance Manager opens.
2. Click **Add**. The Integration Template Selection wizard opens.
3. Select **SMBIR** from the Integration Template list. Ignore the **Import Mapping** check box, which has no effect on this integration.

Note: Only one instance of this integration is allowed. If an instance of this integration already exists in Integration Manager, the **SMBIR** template is unavailable. You have to delete the existing integration instance before you can add a new one.

4. Click **Next**. The Integration Instance Information page opens.
5. Update the following fields:

Note: Only **Name** and **Version** are required fields. This integration does not use the **Interval Time (s)** and **Max Retry Times** fields as it is UI-based.

Field	Value
Name	(Required) The name of the integration instance. Default: SMBIR
Version	(Required) The version of the integration template. Default: 1.0
SM Server	The name of the Service Manager server machine.
Endpoint Server	The name of the OMi Server machine.
Log Level	Select one from: DEBUG, INFO (default), WARNING, ERROR, and OFF.
Log File Directory	A directory on the Service Manager Server machine in which log files will be stored.
Description	If you want, modify the default description of the instance.
Run at system startup	Select this check box only if you want this instance to be automatically enabled when the Service Manager Server is started.

6. Click **Next**. The Integration Instance Parameters page opens.
7. On the **General Parameters** tab, replace "BSM_host" in the **baseurl** parameter with the hostname of the real OMi server.
8. Click **Next** twice and then click **Finish**. Leave the Integration Instance Mapping and Integration

Instance Fields settings blank. This integration does not use these settings.

Service Manager creates the instance. You can edit, enable, disable, or delete it in Integration Manager.

9. Enable the integration instance.



Step 2: Launch a Business Impact Report from an Incident

To launch a Business Impact Report from an incident:

1. Log on to the Service Manager Web client.
2. From **Incident Management**, search for an incident record and open it.
3. Click **More** and then select **Launch Business Impact Report**. The OMi Business Impact window opens, showing the KPI over time data for the related CI and related business services.

Customizing the Service Manager Integration

The ServiceManagerAdapter groovy script is provided for Event Forwarding to Service Manager. You can customize this script for your installations.

To customize the ServiceManagerAdapter groovy script, open the Scripts manager () , select the **sm:ServiceManagerAdapter** script and open it for editing (). The Edit Script window opens. The contents of the script are displayed in the **Script** tab.

Tip: Copying the script text into a text editor of your choice. When you have finished editing, copy the edited text back to the Edit Script window and save the script.

Near the beginning of the script, there are two sections used to modify the default behavior of the OMi event synchronization with Service Manager.

To access

Administration > Setup and Maintenance > Connected Servers

Click the  button.

Configuring the ServiceManagerAdapter Script

This section controls which event and incident properties are synchronized to and from Service Manager, and is contained within the following comments:

- BEGIN Configuration: Customization of properties for synchronization
- END Configuration: Customization of properties for synchronization

The ServiceManagerAdapter script can be configured section contains constants, 6 "maps" and "8" sets to allow configuring the synchronization of the properties. Each is described below:

Service Manager Drilldown Constant

The first variable that can be adjusted is `SM_WEB_TIER_NAME`. Set this value to the base name of the web application deployed in the Tomcat container on the Service Manager system. This web application is used for drilling down into Service Manager. The name is used in the URL path for the drill down. It must match the base name of the web application ("`.war`" is removed). The default is shown below:

```
private static final String SM_WEB_TIER_NAME = 'webtier-9.30'
```

OMi Administrator User

The `BSM_ADMINISTRATOR_LOGIN_NAME` variable is used to contain the name of the OMi Administrator user. By default this is set to `admin`.

For the events that are forwarded automatically by a forwarding rule, the `_is_recorded_by` attribute is set to the user specified in the `BSM_ADMINISTRATOR_LOGIN_NAME` variable.

For the events that are forwarded manually, the `_recorded_by` attribute is set to the user that initiated the forward request.

```
private static final String BSM_ADMINISTRATOR_LOGIN_NAME = 'admin'
```

Enumeration Value Maps

Maps are defined to map enumerated values of the event properties to values on Service Manager incident properties. These maps, in general, may not be customized, but they provide a list of possible values that can be specified in the sets described below. For details on each map, view the actual

values defined in the script.

- **MapOPR2SMStatus:** Maps the event state to the Service Manager incident status
- **MapSM2OPRState:** Maps the Service Manager incident status to the event state
- **MapOPR2SMUrgency:** Maps the event severity to the Service Manager incident urgency
- **MapSM2OPRSeverity:** Maps the Service Manager incident urgency to the event severity
- **MapOPR2SMPriority:** Maps the event priority to the Service Manager incident priority
- **MapSM2OPRPriority:** Maps the Service Manager incident priority to the event priority

Custom Property Maps

The following maps allow a user to map any top-level event property to any top-level Service Manager incident property.

- **MapOPR2SMCustomAttribute:** Maps the specified custom attributes to a Service Manager incident property for synchronization.

Add a CA name to the map along with a Service Manager incident property name (XML tag name).

Target Service Manager Incident property name of "activity_log" will append the CA change to the Service Manager incident activity log.

Note: Only top-level Service Manager incident properties are supported in this map.

- **MapSM2OPRCustomAttribute:** Maps the specified Service Manager incident properties to an event custom attribute for synchronization.

Add a Service Manager incident property name to the map along with an event custom attribute name.

Note: Only top-level Service Manager incident properties are supported in this map.

Examples:

The following synchronizes the event custom attribute `MyCustomCA` to the Service Manager incident `activity_log` and the custom attribute `MyCustomCA1` to the Service Manager incident property `SMCustomAttribute`.

```
private static final Map<String, String> MapOPR2SMCustomAttribute =
["MyCustomCA" : "activity_log", "MyCustomCA1" : "SMCustomAttribute"]
```

The following synchronizes the Service Manager incident property `incident_status` to the custom attribute `SMIncidentStatus`.

```
private static final Map<String, String> MapSM2OPRCustomAttribute = ["incident_
status" : "SMIncidentStatus"]
```

Synchronization Change Sets

The following sets define which properties and enumerated values are synchronized whenever a change occurs in the OMi event or Service Manager incident. The properties synchronized upon a change as standard are marked in **bold**. For each list, the value of "*" can be specified. In this case, all possible properties or enumerated values are synchronized for the specified list.

Note: When the Service Manager incident is created, all possible event properties and enumerated values are set in the Service Manager incident. The following sets are mainly used for synchronization of changes.

SyncOPRPropertiesToSM

Event properties to synchronize to a corresponding Service Manager Incident property on change:

- title
- **description**
- **state**
- severity
- priority
- **solution**
- assigned_user
- assigned_group

SyncOPRPropertiesToSMActivityLog

Event properties to synchronize to a corresponding Service Manager Incident activity log on change:

- **title**
- description

- **state**
- **severity**
- **priority**
- solution
- **annotation**
- **duplicate_count**
- **custom_attribute**
- **cause**
- **symptom**
- control_transferred_to
- **assigned_user**
- **assigned_group**

SyncSMPropertiesToOPR

Service Manager Incident properties to synchronize to a corresponding event property on change:

- name
- **description**
- **incident_status**
- urgency
- priority
- **solution**

SyncOPRStatesToSM

Event states to synchronize to the Service Manager incident status on change:

Note: state must be included in SyncOPRPropertiesToSM or this list is ignored.

- open
- in_progress
- in_progress

- resolved
- **closed**

SyncOPRSeveritiesToSM

Event severities to synchronize to the Service Manager incident urgency on change:

Note: severity must be included in `SyncOPRPropertiesToSM` or this list is ignored.

- **critical**
- **major**
- **minor**
- **warning**
- **normal**
- **unknown**

SyncSMSStatusToOPR

Service Manager incident status to synchronize to the event states on change:

Note: status must be included in `SyncSMPPropertiesToOPR` or this list is ignored.

- accepted
- assigned
- open
- reopened
- pending-change
- pending-customer
- pending-other
- pending-vendor
- referred
- suspended
- work-in-progress
- rejected

- replaced-problem
- resolved
- cancelled
- **closed**

SyncSMUrgenciesToOPR

Service Manager incident urgencies to synchronize to the event severities on change:

Note: urgency must be included in `SyncSMPropertiesToOPR` or this list is ignored.

Acceptable values are **1-4**.

SyncSMPrioritiesToOPR

Service Manager incident priorities to synchronize to the event priorities on change:

Note: priority must be included in `SyncSMPropertiesToOPR` or this list is ignored.

Acceptable values are **1-4**.

Examples:

The following example synchronizes the OMi title, state and description to the Service Manager incident whenever the corresponding property is changed in the OMi event.

```
private static final Set SyncOPRPropertiesToSM = ["title", "state", "description"]
```

The following example will synchronize the OMi states resolved and closed to the Service Manager incident whenever the corresponding property is changed in the OMi event.

```
private static final Set SyncOPRStatesToSM = ["resolved", "closed"]
```

Note: The properties that are synchronized to the Service Manager activity log are concatenated together for each change and then appended to the Service Manager incident activity log.

Localization

This section is provided to enable localizing some of the text that is displayed in the:

- The Event Browser **Forwarding** tab (not available for an Event Channel deployment)
- Service Manager incident activity log

This sections is contained within the following comments:

- BEGIN Localization: Customization of text values for language localization
- END Localization: Customization of text values for language localization

The following sections describe the text that can be localized.

Forwarding tab

The Service Manager incident properties urgency and priority are of type integer. In order to display a more meaningful value in the Forwarding tab, maps are provided to display a string. These strings may be localized for display in the browser.

- **Service Manager Urgency values**

The text value will be displayed on the **Forwarding** tab.

Note: This text may be localized for the desired locale.

```
privatestaticfinal Map SMUrgency = ["1": "1 - Critical", "2": "2 - High", "3":  
"3 - Average", "4": "4 - Low"]
```

- **Service Manager Priority values**

The text value will be displayed on the **Forwarding** tab.

Note: This text may be localized for the desired locale.

```
privatestaticfinal Map SMPriority = ["1": "1 - Critical", "2": "2 - High", "3":  
"3 - Average", "4": "4 - Low"]
```

Service Manager Incident Activity Log

Synchronization from OMi to Service Manager appends various text to the Service Manager incident activity log. This text may be localized as follows.

- General Locale Setting: Used mainly in formatting of dates. May be changed, for example to Locale.JAPAN. See Java *Locale* class documentation for all possible values.

```
private static final Locale LOCALE = Locale.getDefault()
```

- Annotation date format: See Java *SimpleDateFormat* class documentation for details on the syntax. Script default is below.

```
private static final String ANNOTATION_DATE_FORMAT = "yyyy.MM.dd HH:mm:ss z"
```

- Description: In Service Manager the incident description is a required attribute. In case it is not set in OMi this value is taken. An empty string is NOT allowed.

```
private static final String EMPTY_DESCRIPTION_OVERRIDE = "<none>"
```

- Log Text: The following text is prefixed to the appropriate event property when synchronizing it to an Service Manager Incident activity log.

NOTE: This text may be localized for the desired locale. Defaults are as shown below.

```
private static final String ACTIVITY_LOG_TITLE = "[Title]\n"
```

```
private static final String ACTIVITY_LOG_TITLE_CHANGE = "Event title changed to:
"
```

```
private static final String ACTIVITY_LOG_STATE = "[State]\n"
```

```
private static final String ACTIVITY_LOG_STATE_CHANGE = "Event state changed to:
"
```

```
private static final String ACTIVITY_LOG_DESCRIPTION = "[Description]\n"
```

```
private static final String ACTIVITY_LOG_DESCRIPTION_CHANGE = "Event description
changed to: "
```

```
private static final String ACTIVITY_LOG_SOLUTION = "[Solution]\n"
```

```
private static final String ACTIVITY_LOG_SOLUTION_CHANGE = "Event solution
changed to: "
```

```
private static final String ACTIVITY_LOG_ASSIGNED_USER = "[Assigned User]\n"
```

```
private static final String ACTIVITY_LOG_ASSIGNED_USER_CHANGE = "Event assigned
user changed to: "
```

```
private static final String ACTIVITY_LOG_ASSIGNED_GROUP = "[Assigned Group]\n"
```

```
private static final String ACTIVITY_LOG_ASSIGNED_GROUP_CHANGE = "Event assigned
group changed to: "
```

```
private static final String ACTIVITY_LOG_SEVERITY = "[Severity]\n"
```

```
private static final String ACTIVITY_LOG_SEVERITY_CHANGE = "Event severity
changed to: "
```

```

private static final String ACTIVITY_LOG_PRIORITY = "[Priority]\n"

private static final String ACTIVITY_LOG_PRIORITY_CHANGE = "Event priority
changed to: "

private static final String ACTIVITY_LOG_CONTROL_TRANSFERRED_TO = "[Control
Transferred To]\n"

private static final String ACTIVITY_LOG_CONTROL_TRANSFERRED_TO_CHANGED = "Event
control transfer state changed to: "

private static final String ACTIVITY_LOG_ANNOTATION = "[Annotation]\n"

private static final String ACTIVITY_LOG_CA = "[Custom Attribute]\n"

private static final String ACTIVITY_LOG_CAUSE = "[Cause] "

private static final String ACTIVITY_LOG_OMI_CAUSE = "[OMi Cause] "

private static final String ACTIVITY_LOG_OMI_SYMPTOM = "[OMi Symptom] "

private static final String ACTIVITY_LOG_DUPLICATE_COUNT = "[Duplicate Count] "

private static final String ACTIVITY_LOG_PREVIOUS = "previous "

private static final String ACTIVITY_LOG_CURRENT = "current "
    
```

Mapping Table: OMi Event to BDM Incident Property

The standard integration synchronizes the following OMi Event properties to Service Manager Incident properties:

OMi UI (Event)	OMi UI (Forwarding)	OMi Web Service (Event)	Service Manager Web Service (Incident)	Service Manager Object	Service Manager UI	Comments
-	-	-	global_id	id	-	There is no mapping and no synchronization for global_id between an OMi event and a Service Manager

OMi UI (Event)	OMi UI (Forwarding)	OMi Web Service (Event)	Service Manager Web Service (Incident)	Service Manager Object	Service Manager UI	Comments
						incident.
ID	-	id	external_process_reference	external.processes.reference	-	Set only on Service Manager incident creation.
-	External ID	control_transferred_to_external_id	reference_number	number	Incident ID	Set only on Service Manager incident creation.
Title	-	title	name	brief.description	Title	Set on incident creation. Standard configuration: only the OMi title changes are synchronized to the Service Manager incident activity log. If the event title exceeds 256 characters, or contains a newline character, it is truncated and the entire title is prepended to the description.
Description	-	description	description	action	Description	Can be a combination of the OMi event title and description. See title

OMi UI (Event)	OMi UI (Forwarding)	OMi Web Service (Event)	Service Manager Web Service (Incident)	Service Manager Object	Service Manager UI	Comments
						comments for details. Standard configuration: synchronized in both directions.
Solution	-	solution	solution	Resolution	Solution	Standard configuration: synchronized in both directions.
Lifecycle State	-	state	incident_status	problem.status	Status	Set on incident creation. Standard configuration: only 'closed' state is synchronized.
Severity	Severity	severity	urgency	severity	Urgency	Set on incident creation. Standard configuration: all value changes are synchronized.
Priority	Priority	priority	priority	priority.code	Priority	Set on incident creation. Standard configuration: all value changes are synchronized.
Assigned User	-	assigned_user_login_name	is_requested_by_party_display_label	contact.name	Contact	By default not synchronized.

OMi UI (Event)	OMi UI (Forwarding)	OMi Web Service (Event)	Service Manager Web Service (Incident)	Service Manager Object	Service Manager UI	Comments
-	Assigned User	-	has_assigned_party_display_label	assignee.name	Assignee	OMi queries the Service Manager Incident Web Service in real time for display in Forwarding Tab only. No synchronization between the OMi event and the Service Manager incident.
-	-	control_transferred_to_initiated_by	is_recorded_by_party_display_label	opened.by	Opened By	By default not synchronized.
Assigned Group	Assigned Group	assigned_group_name	has_assigned_group_functional_group_display_label	assignment	Assignment Group	OMi queries the Service Manager Incident Web Service in real time for display on the Forwarding tab only. No synchronization between the OMi event and the Service Manager incident.
Category	-	category	category	sub_category	Area	Category is set by OMi only on Service

OMi UI (Event)	OMi UI (Forwarding)	OMi Web Service (Event)	Service Manager Web Service (Incident)	Service Manager Object	Service Manager UI	Comments
						Manager incident creation, but is by default ignored in Service Manager.
Subcategory	-	sub_category	sub_category	product_type	Subarea	Subcategory is set by OMi only on Service Manager incident creation, but is by default ignored in Service Manager.
Related CI	-	related_ci	is_registered_for	logical.name	Affected CI	Affected CI is set by OMi only on Service Manager incident creation.
Annotations	-	annotation_list	activity_log_description	update.action	Activity Log	Synchronized from OMi to Service Manager only. OOTB synchronization enabled.
Custom Attributes	-	custom_attribute_list	activity_log_description	update.action	Activity Log	Can be configured for synchronization to a specific Service Manager incident

OMi UI (Event)	OMi UI (Forwarding)	OMi Web Service (Event)	Service Manager Web Service (Incident)	Service Manager Object	Service Manager UI	Comments
						property, or the activity log. For Service Manager activity log, synchronization is from OMi to Service Manager only. Standard configuration: synchronization disabled.
Cause	-	cause-> control_transferred_to_external_id	is_caused_by-master_reference_number	Links the two SM Incidents	Related Records	If the cause event has been synchronized to Service Manager, the two Service Manager Incidents are related, otherwise information about the OMi cause is appended to the Service Manager incident activity log. Standard configuration: synchronization enabled.
Symptoms	-	symptom_list	activity_log description	update.action	Activity Log	Synchronization is from OMi to Service Manager only.

OMi UI (Event)	OMi UI (Forwarding)	OMi Web Service (Event)	Service Manager Web Service (Incident)	Service Manager Object	Service Manager UI	Comments
						Standard configuration: synchronization enabled.
Duplicate Count	-	duplicate_count	activity_log description	update.action	Activity Log	Synchronization is from OMi to Service Manager only. Standard configuration: synchronization enabled.

Chapter 23: OMi-SM Integration with UCMDB

This section describes the integration of Service Manager with OMi in the case of an external UCMDB.

This section includes:

- ["Data Flow Probes" on the next page](#)
- ["Create User Accounts for the OMi-SM Integration \(UCMDB\)" on page 168](#)
- ["UCMDB-Service Manager Integration" on page 169](#) (prerequisite for all other integration options)
- ["OMi-UCMDB Integration" on page 169](#) (prerequisite for all other integration options)
- ["Enable LW-SSO for the OMi-SM Integration \(UCMDB\)" on page 170](#)
- ["View Actual State in SM \(UCMDB\)" on page 178](#)
- ["Event Forwarding from OMi to SM \(UCMDB\)" on page 179](#)
- ["Downtime Forwarding from Service Manager to OMi \(UCMDB\)" on page 201](#)
- ["Sending downtime notifications from OMi to SM \(UCMDB\)" on page 210](#)
- ["View Changes and Incidents in OMi \(UCMDB\)" on page 212](#)
- ["Business Impact Report \(BIR\) \(UCMDB\)" on page 218](#)

Data Flow Probes

Figure: Setup OMi with a UCMDB and two Data Flow Probes

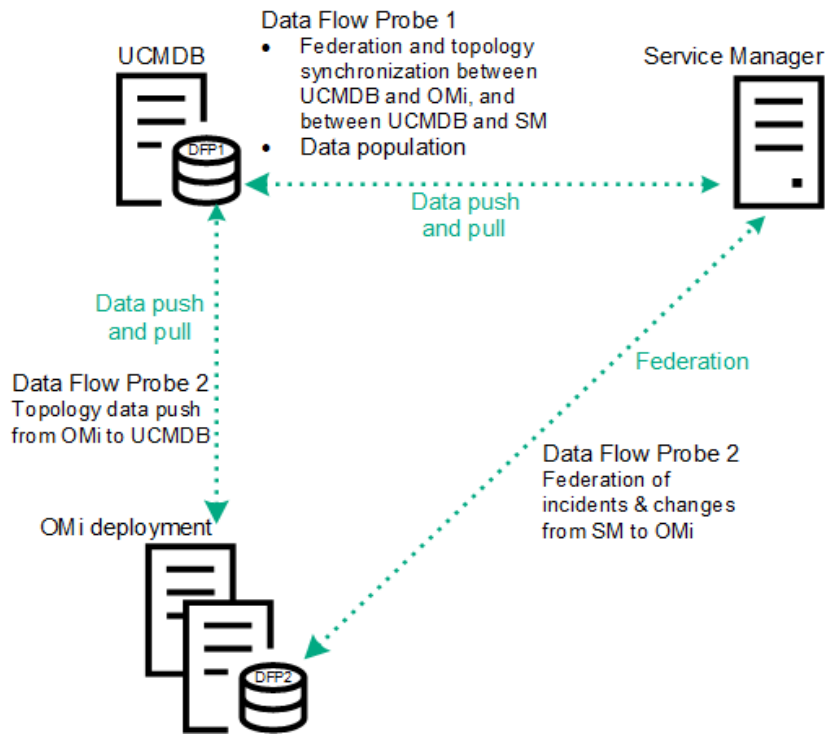

The DFP1 is necessary for

- Topology synchronization (CIs) between UCMDB and OMi
- Topology synchronization (CIs) between UCMDB and Service Manager

DFP2 is necessary for

- Topology data push from OMi to UCMDB
- Federation of incidents and changes from SM into OMi

Create User Accounts for the OMi-SM Integration (UCMDB)

The OMi-SM integration requires integration accounts to be set up for the three systems to access each other.

1. In Service Manager, create an operator record with system administration privileges, and give it a descriptive name, like UCMDBSMIntegrUser.

To create a dedicated integration user account in SM:

- a. Log on to SM as a system administrator.
- b. Type **contacts** in the SM command line, and press **ENTER**.
- c. Create a new contact record for the integration user account.
 - i. In the **Full Name** field, type a full name. For example, UCMDB.
 - ii. In the **Contact Name** field, type a name. For example, UCMDB.
 - iii. Click **Add**, and then **OK**.
- d. Type **operator** in the SM command line, and press **ENTER**.
- e. In the **Login Name** field, type the user name of an existing system administrator account, and click **Search**.

The system administrator account displays.

- f. Create a new user account based on the existing one:
 - i. Change the **Login Name** to the integration account name you want (for example, UCMDB).
 - ii. Type a **Full Name**. For example, RTSM.
 - iii. In the **Contact ID** field, click the **Fill** button and select the contact record you have just created.
 - iv. Click **Add**.
 - v. Select the **Security** tab, and change the password.
 - vi. Click **OK**.

This is the user account that the OMi server uses to access Service Manager. It is used to forward events and retrieve incidents and RFCs from Service Manager. Remember the user name and password you specify here, as the UCMDB system will need them to access the Service Manager target server in later steps.

2. On each OMi server, create a user account with system administration privileges. This account is used by SM to access the OMi system to retrieve the actual state information of a CI. Give it a descriptive name, like `SMOMiIntegrUser`.

Remember the user name and password you specify here, as Service Manager will need the accounts to access the OMi server(s) in later steps.

3. In OMi, create a user account with the system administration privileges for the UCMDB-OMi integration. Give it a descriptive name, like `UCMDBOMiIntegrUser`. Remember the user name and password you specify here, as the UCMDB system will need the account details to access the OMi server in later steps.
4. In UCMDB, create a user account with system administration privileges for the OMi-UCMDB integration. Give it a descriptive name, like `OMiUCMDBIntegrUser`. Remember the user name and password you specify here, as OMi will need the account details to access the UCMDB server in later steps.
5. In UCMDB, create a user account with system administration privileges for the SM-UCMDB integration. Give it a descriptive name, like `SMUCMDBIntegrUser`. Remember the user name and password you specify here, as SM will need the account to access the UCMDB server in later steps.

UCMDB-Service Manager Integration

For details about how to integrate UCMDB with Service Manager, see the *HPE Service Manager Universal CMDB Integration Guide*. This integration, and the OMi-UCMDB integration, which synchronize important CIs, such as services, business applications and infrastructure CIs, are prerequisites for all other integration features.

OMi-UCMDB Integration

For details about how to integrate UCMDB with OMi, see *Universal CMDB Online Help* and the *RTSM Best Practices* document.

Enable LW-SSO for the OMi-SM Integration (UCMDB)

Lightweight Single Sign-On (LW-SSO) is optional but recommended for the OMi-SM Integration. You have different LW-SSO configuration choices depending on your needs. The following describes how LW-SSO can be used in the OMi-SM workflow.

LW-SSO options for the OMi-SM integration

When OMi creates an incident from an OMi event record

OMi creates an incident from an OMi event record by sending RESTful-based requests to Service Manager. The incident ID is then stored in the event record.

LW-SSO is NOT needed in this process. A dedicated Service Manager user account was specified when configuring the Service Manager integration in OMi. OMi uses this dedicated user account when calling the Service Manager RESTful Web Service to create the incident.

When an OMi user views the incident details

The user can log in to Service Manager and view the incident details by using the incident ID stored in the event record.

If the user wants to view the incident details by clicking the incident link from the event record, LW-SSO can be used; otherwise a Service Manager login prompt will appear.

LW-SSO is optional for this process. To enable LW-SSO for this process, configure LW-SSO in both the Service Manager server and Web tier (because the server needs to trust the Web tier), as well as in OMi.

When Service Manager synchronizes the OMi incident status back to OMi

When a user has updated the OMi incident, Service Manager calls the OMi server's RESTful Web Service to update the incident changes to the OMi event record.

LW-SSO is NOT needed in this process. A dedicated OMi user account was specified when the Incident Exchange (OMi - SM) integration was set up in SMIS, and Service Manager uses this user account when calling the OMi server's RESTful Web Service to synchronize the incident status back to the OMi event record.

When a user views the event details or the Business Impact Report from an OMi incident

The user clicks the **View OMi Event** option or **Launch Business Impact Report** from the incident to view the event details or Business Impact Report.

LW-SSO is optional for this process. If you enable LW-SSO in the Service Manager Web tier and in OMi, the OMi login prompt is bypassed.

Required user permissions

In order to be able to view events, a user needs to be assigned a role with sufficient permission to read events. To manage permissions in OMi, select:

Administration > Users > Users, Groups, and Roles

Select a role or create a new one. In the Permissions section, go to the **Operations Console** category, select **Events** and specify the actions users can perform on **Events assigned to user**.

You can optionally grant the permission to view events not assigned to each user.

When CIs are synchronized between OMi/UCMDB and SM

LW-SSO is NOT needed in this process. Dedicated users are specified in the OMi-UCMDB, UCMDB-SM and OMi-SM integration points.

Configuring LW-SSO for the OMi-SM integration

To use LW-SSO for the SM-OMi integration, LW-SSO must be enable for both products. In SM, you must enable LW-SSO in both the SM server and web tier.

Step 1: Configure LW-SSO in the SM server

Service Manager servers, version 9.30 and later, support Lightweight Single Sign-On (LW-SSO). A Service Manager integration can pass an authentication token to Service Manager and does not require re-authentication. This simplifies the configuration of Single Sign-On for HPE solutions by removing the

need to use Symphony Adapter (which proxies LW-SSO-based authentication with the Service Manager Trusted Sign-On solution).

Enabling LW-SSO in the Service Manager server enables web service integrations from other HPE products (for example, Release Control) to bypass Service Manager authentication if the product user is already authenticated and a proper token is used; enabling LW-SSO in both the Service Manager server and web tier enables users to bypass the login prompts when launching the Service Manager web client from other HPE applications.

Note: Existing integrations that use the Symphony Adapter and Trusted Sign-On rather than this new LW-SSO mechanism can continue to work.

To configure LW-SSO in the Service Manager server:

1. Go to the <Service Manager server installation path>/RUN folder, and open `lwssofmconf.xml` in a text editor.
2. Make sure that the `enableLWSSOFramework` attribute is set to `true` (default).
3. Change the domain value `example.com` to the domain name of your Service Manager server host.

Note: To use LW-SSO, your Service Manager web tier and server must be deployed in the same domain; therefore you should use the same domain name for the web tier and server. If you fail to do so, users who log in from another application to the web tier can log in but may be forcibly logged out after a while.

4. Set the `initString` value. This value MUST be the same with the LW-SSO setting of the other HPE product you want to integrate with Service Manager.

Note:

- LW-SSO version 2.5 is supported.
- Optionally, you can change attributes `paddingModeName`, `keySize`, `encodingMode`, `engineName`, and `cipherType`. However, you must make sure that they are same with the LW-SSO setting of the other HPE product that you want to integrate with Service Manager.
- Do not change the other configurations, such as the content in tag `<restURLs>`, and the attribute of tag `<service>`.

Example:

```
<?xml version="1.0" encoding="UTF-8"?>
<lwss-config xmlns="http://www.hpe.com/astsecurity/idmenablmentfw/lwssso/2.0">
  <enableLWSSO enableLWSSOFramework="true"
    enableCookieCreation="true" cookieCreationType="LWSSO" />
  <web-service>
```

```

<inbound>
  <restURLs>
    <url>.*7/ws.*</url>
    <url>.*sc62server/ws.*</url>
    <url>.*ui.*</url>
  </restURLs>
  <service service-type="rest" >
    <in-lwssso>
      <lwsssoValidation>
        <domain>example.com</domain>
        <crypto cipherType="symmetricBlockCipher" engineName="AES"
          paddingModeName="CBC" keySize="256" encodingMode="Base64Url"
          initString="This is a shared secret passphrase"</crypto>
      </lwsssoValidation>
    </in-lwssso>
  </service>
</inbound>
<outbound/>
</web-service>
</lwssso-config>

```

Step 2: Configure LW-SSO in the SM Web Tier

If Lightweight Single Sign-On (LW-SSO) is enabled in the Service Manager Web tier, integrations from other HPE products will bypass Service Manager authentication when launching the Service Manager Web client, provided that the HPE product user is already authenticated and a proper token is used.

Note:

- To enable users to launch the Web client from another HPE product by using LW-SSO, you must also enable LW-SSO in the Service Manager server.
- Once you have enabled LW-SSO in the web tier, web client users should use the web tier server's fully-qualified domain name (FQDN) in the login URL:
<http://<myWebtierHostName>.<myDomain>:<port>/webtier-x.xx/index.do>

The following procedure is provided as an example, assuming that the Service Manager Web tier is deployed on Tomcat.

To configure LW-SSO in the Service Manager Web tier:

1. Open the <Tomcat>\webapps\<< Service Manager web tier>\WEB-INF\web.xml file in a text editor.
2. Modify the web.xml file as follows:

- a. Set the `<serverHost>` parameter to the fully-qualified domain name of the Service Manager server.

Note: This is required to enable LW-SSO from the web tier to the server.

- b. Set the `<serverPort>` parameter to the communications port of the Service Manager server.
- c. Set the `secureLogin` and `sslPort` parameters.

- If you do not want to configure TLS between Tomcat and the browser, set `secureLogin` to `false`.
- We recommend that you enable secure login in a production environment. Once `secureLogin` is enabled, you must configure TLS for Tomcat. For details, see the Apache Tomcat documentation.

- d. Change the value of context parameter **isCustomAuthenticationUsed** to `false`.
- e. Remove the comment tags (`<!--` and `-->`) enclosing the following elements to enable LW-SSO authentication.

```
<!--
  <filter>
    <filter-name>LWSSO</filter-name>
    <filter-class>com.hp.sw.bto.ast.security.lwssso.LWSSOFilter</filter-
class>
  </filter>
-->
.....
<!--
  <filter-mapping>
    <filter-name>LWSSO</filter-name>
    <url-pattern>/*</url-pattern>
  </filter-mapping>
-->
```

- f. Save the `web.xml` file.
3. Open the `<Tomcat>\webapps\<Service Manager Web tier>\WEB-INF\classes\lwssofmconf.xml` file in a text editor.
 4. Modify the `lwssofmconf.xml` file as follows:
 - a. Set the value of `enableLWSSOFramework` to `true` (default is `false`).
 - b. Set the `<domain>` parameter to the domain name of the server where you deploy your Service Manager Web tier. For example, if your Web tier's fully qualified domain name is `mywebtier.domain.example.com`, then the domain portion is `domain.example.com`.

Note: To use LW-SSO, your Service Manager web tier and server must be deployed in the same domain; therefore you should use the same domain name for the web tier and server. If you fail to do so, users who log in from another application to the web tier can log in but may be forcibly logged out after a while.

- c. Set the `<initString>` value to the password used to connect HPE applications through LW-SSO (minimum length: 12 characters). For example, `smintegrationlwssso`. Make sure that other HPE applications (for example, Release Control) connecting to Service Manager through LW-SSO share the same password in their LW-SSO configurations.
- d. In the `<multiDomain>` element, set the trusted hosts connecting through LW-SSO. If the Service Manager web tier server and other application servers connecting through LW-SSO are in the same domain, you can ignore the `<multiDomain>` element ; If the servers are in multiple domains, for each server, you must set the correct `DNSDomain` (domain name), `NetBiosName` (server name), `IP` (IP address), and `FQDN` (fully-qualified domain name) values. The following is an example.

```
<DNSDomain>example.com</DNSDomain>
<NetBiosName>myserver</NetBiosName>
<IP>1.23.456.789</IP>
<FQDN>myserver.example.com</FQDN>
```

Note: As of version 9.30, Service Manager uses `<multiDomain>` instead of `<protectedDomains>`, which is used in earlier versions. The multi-domain functionality is relevant only for UI LW-SSO (not for web services LW-SSO). This functionality is based on the HTTP referrer. Therefore, LW-SSO supports links from one application to another and does not support typing a URL in a browser window, except when both applications are in the same domain.

- e. Check the `secureHTTPCookie` value (default: true).
 - If you set `secureHTTPCookie` to true (default), you must also set `secureLogin` in the `web.xml` file to true (default); if you set `secureHTTPCookie` to false, you can set `secureLogin` to either true or false. In a production environment, you are recommended to set both parameters to true.
 - If you do not want to use TLS, set both `secureHTTPCookie` and `secureLogin` to false.

Here is an example of `lwssofmconf.xml`:

```

<?xml version="1.0" encoding="UTF-8"?>
<lwssso-config
xmlns="http://www.hp.com/astsecurity/idmenablmentfw/lwssso/2.0">

  <enableLWSSO
    enableLWSSOFramework="true"
    enableCookieCreation="true"
    cookieCreationType="LWSSO"/>

  <webui>
    <validation>
      <in-ui-lwssso>
        <lwsssoValidation id="ID000001">
          <domain>example.com</domain>
          <crypto cipherType="symmetricBlockCipher"
            engineName="AES" paddingModeName="CBC" keySize="256"
            encodingMode="Base64Url"
            initString="This is a shared secret passphrase"/>
        </lwsssoValidation>
      </in-ui-lwssso>

      <validationPoint
        enabled="false"
        refid="ID000001"
        authenticationPointServer="http://server1.example.com:8080/bsf"/>

    </validation>

    <creation>
      <lwsssoCreationRef useHTTPOnly="true" secureHTTPCookie="true">
        <lwsssoValidationRef refid="ID000001"/>
        <expirationPeriod>50</expirationPeriod>
      </lwsssoCreationRef>
    </creation>

    <logoutURLs>
      <url>./goodbye.jsp.</url>
      <url>./cwc/logoutcleanup.jsp.</url>
    </logoutURLs>

    <nonsecureURLs>
      <url>./images/.</url>
      <url>./js/.</url>
      <url>./css/.</url>
      <url>./cwc/tree/.</url>
      <url>./sso_timeout.jsp.</url>
    </nonsecureURLs>

```



```

    <multiDomain>
      <trustedHosts>
        <DNSDomain>example.com</DNSDomain>
        <DNSDomain>example1.com</DNSDomain>
        <NetBiosName>myserver</NetBiosName>
        <NetBiosName>myserver1</NetBiosName>
        <IP>xxx.xxx.xxx.xxx</IP>
        <IP>xxx.xxx.xxx.xxx</IP>
        <FQDN>myserver.example.com</FQDN>
        <FQDN>myserver1.example1.com</FQDN>
      </trustedHosts>
    </multiDomain>
  </webui>

  <lwssso-plugin type="Acegi">
    <roleIntegration
      rolePrefix="ROLE_"
      fromLWSSO2Plugin="external"
      fromPlugin2LWSSO="enabled"
      caseConversion="upperCase"/>

    <groupIntegration
      groupPrefix=""
      fromLWSSO2Plugin="external"
      fromPlugin2LWSSO="enabled"
      caseConversion="upperCase"/>
  </lwssso-plugin>
</lwssso-config>

```

f. Save the `lwsssofmconf.xml` file.

5. Open the `<Tomcat>\webapps\<Service Manager Web tier>\WEB-INF\classes\application-context.xml` in a text editor.

6. Modify the `application-context.xml` as follows:

a. Add `lwSsoFilter` to `filterChainProxy`:

```

/**=httpSessionContextIntegrationFilter,
lwSsoFilter,anonymousProcessingFilter

```

Note: If you need to enable web tier LW-SSO for integrations and also enable trusted sign-on for your web client users, add `lwSsoFilter` followed by `preAuthenticationFilter`, as shown in the following:

```

/**=httpSessionContextIntegrationFilter,
lwSsoFilter,preAuthenticationFilter,anonymousProcessingFilter.

```

- b. Uncomment bean lwSsoFilter:

```
<bean id="lwSsoFilter"  
class="com.hp.ov.sm.client.webtier.lwssso.LwSsoPreAuthenticationFilter">
```

- c. Save the application-context.xml file.
7. Repack the updated Service Manager web tier files and replace the old web tier .war file deployed in the <Tomcat>\webapps folder.
8. Restart Tomcat so that the configuration takes effect.

Step 3: Configure LW-SSO in OMi

- In OMi:
 - a. Navigate to Authentication Management:
Administration > Users > Authentication Management
 - b. In the Single Sign-On Configuration section, click  **Edit** to open Single Sign On Editor panel.
 - c. In the Single Sign On Editor panel, select **Lightweight**.
 - d. Paste the **Token Creation Key (initString)** value that you copied above from **JMX to get/set Token Creation Key (initString)** to the **Token Creation String (initString)**.
 - e. Click **Save** to save your configuration.

For details on configuring LW-SSO, see the *OMi Administration Guide*.

View Actual State in SM (UCMDB)

To display the Actual State information in the SM configuration item form, do the following:

1. Log on to SM as a system administrator.
2. Click **System Administration > Base System Configuration > Miscellaneous > System Information Record**.
3. Click the **Active Integrations** tab.
4. Select the **HP Universal CMDB** option.

The form displays the UCMDB web service URL field.

5. In the UCMDB web service URL field, type the URL to the Universal CMDB web service API. The URL has the following format:

http://<UCMDB server name>:<port>/axis2/services/ucmdbSMService

6. In the **UserId** and **Password** fields, type the user credentials that are required to manage CIs on the UCMDB system.

Replace <UCMDB server name> with the host name of your UCMDB server, and replace <port> with the port used by your UCMDB server web service.

7. Click **Save**. SM displays the message: **Information record updated**.
8. Log out of the SM system.
9. To verify that the setup worked, log back into the SM system with an administrator account. The **Actual State** section will be available in CI records pushed from OMi.

Event Forwarding from OMi to SM (UCMDB)

OMi enables you to forward events from OMi to Service Manager, which then become incidents in Service Manager. Subsequent event/incident changes are synchronized between Service Manager and OMi. You can also drill down from OMi events to Service Manager incidents and vice versa.

Follow the steps below to set up an incident exchange between Service Manager and OMi.

This section includes:

- ["Step 1: Configure the Service Manager server as a connected server in OMi" on the next page](#)
- ["Step 2: \(optional\) Configure an Event Forwarding Rule " on page 183](#)
- ["Step 3: Configure the OMi integration in Service Manager" on page 184](#)
- ["Step 4: Configure Launch of Service Manager Incident Details from OMi" on page 189](#)
- ["\(optional\) Step 5: Attribute Synchronization" on page 190](#)
- ["Step 6: Test the Event Forwarding and Cross Launches" on page 196](#)
- ["Advanced Configuration" on page 197](#)

Step 1: Configure the Service Manager server as a connected server in OMi

To synchronize events and event changes between OMi and Service Manager incidents, configure Service Manager as a target connected server in the OMi Connected Servers manager.

To configure the Service Manager server as a target connected server, perform the following steps:

1. Navigate to the Connected Servers manager:

Administration > Setup and Maintenance > Connected Servers

2. In the central Connected Servers pane, click *** New** and select **External Event Processing**. Alternatively, you can click *** New** in the External Event Processing area in the right pane.

The Create External Event Processing Server panel opens.

3. In the General section, enter a display label (a name for the target Service Manager server), an identifier (a unique internal name if you want to replace the automatically generated one), and, optionally, a description of the connection being specified.

Note: The Identifier field is filled in automatically. For example, if you enter *Service Manager 1* as the display label for the target Service Manager server, *Service_Manager_1* is automatically inserted in the Identifier field.

Make a note of the name of the new target server (in this example, *Service_Manager_1*). You must provide it later as the user name when configuring the Service Manager server to communicate with the server hosting OMi.

4. In the Server Properties section, complete the following information:
 - a. Enter the fully qualified domain name of the Service Manager target server.
 - b. From the drop-down list, select the **Service Manager System** CI type.
 - c. *Optional.* Customize the way events and change notifications are delivered to this server by using Advanced Delivery Options:
 - **Serial:** Events and change notifications are delivered serially in the order in which they were received.
 - **Serial per source:** *Default.* Each originating server is provided with a dedicated outgoing request delivery path. For each individual outgoing request delivery path, events and

change notifications are delivered serially in the order in which they were received. This can increase the throughput for delivery of events and change notifications when many events are received from multiple originating servers, while maintaining the incoming order.

- **Parallel:** The configured number of outgoing request delivery paths is used when forwarding events and change notifications. This can further increase the throughput for delivery of events and change notifications. However, because the source of the event is not considered, maintenance of the incoming order cannot be guaranteed.
5. In the Integration Type section, complete the following information:
 - a. Select **Call Script Adapter** as the integration type.
 - b. From the Script name drop-down list, select the Service Manager Groovy script adapter **sm:ServiceManagerAdapter**.
 - c. Specify a maximum transaction time value (the time limit for the execution of the script). The default value is 60 seconds.
 6. In the Outgoing Connection section, enter the user credentials (user name and password) and the port number required to access the Service Manager target server and to forward events to that server:
 - a. In the Username field, enter the user name for the integration user you set up in Service Manager.
 - b. In the Password field, enter the password for the user you specified. Repeat the password for verification.
 - c. In the Port field, specify the port configured on the Service Manager side for the integration with OMi.

To find the port number to enter:

- If you are using default ports in Service Manager, select or clear **Use secure HTTP** as appropriate, and then click **Set default port**. The port is set automatically.

Note: If you do not want to use secure HTTP, make sure that the **Use secure HTTP** check box is cleared.

If the Use secure HTTP check box is selected, download and install a copy of the target server's TLS certificate by clicking **import the certificate**, and then clicking the **Connect and Import from Server** or **Import from File** button, if the certificate is available in a local file.

- If you need to find the port number, access the following file on your Service Manager

system:

```
<Service Manager root directory>/HP/Service Manager  
<version>/Server/RUN/sm.cfg
```

In the `sm.cfg` file, check for the `sm -loadBalancer` line and add the port entry at the end of the line. The line looks similar to this:

```
sm -loadBalancer -httpPort:13080
```

Enter the appropriate value of the port used by Service Manager in the **Port** field of the Outgoing Connection section.

- d. Select the **Enable synchronize and transfer control** check box.

If the Enable synchronize and transfer control check box is selected, an OMi operator can transfer ownership of the event to the target connected server by using the Transfer Control option in the Event Browser context menu. If it is not selected, the Synchronize and Transfer Control option is not available from the Event Browser context menu or from the list of forwarding types for configuring forwarding rules.

7. In the Incoming Connection section, select the **Accept event changes from external event processing server** check box, and then enter a password that the Service Manager server requires to connect to the server hosting OMi.

Note: Make a note of this password. You must provide it later when configuring the Service Manager server to communicate with the server hosting OMi. This password is associated with the user name (`Service_Manager_1`) you configured in Service Manager.

If **Enable synchronize and transfer control** was previously selected, the **Accept event changes from external event processing server** option is assumed and cannot be disabled.

8. In the Event Drilldown section, complete the following information:
 - a. Enter the fully qualified domain name and port of the Service Manager system into which you want to perform the incident drill down. The default port value is automatically inserted and can be restored by clicking **Set default port**.

Note: To enable incident drill down to Service Manager, you must install a web tier client for your Service Manager server according to your Service Manager server installation or configuration instructions.

In the **Event Drilldown** section, configure the server where you installed the web tier client along with the configured port used.

If you do not specify a server in the Event Drilldown section, it is assumed that the web tier client is installed on the server used for forwarding events and event changes to SM, and receiving event changes back from Service Manager.

If nothing is configured in the Event Drilldown section, and the web tier client is not installed on the Service Manager server machine, the web browser will not be able to find the requested URL.

- b. *Optional.* Select the **Use secure HTTP** check box for secure communication.
9. In the Test Connection section, click  **Run Test** to check that the specified connection attributes are correct. If an error message is displayed, correct the connection information, and retest the connection.
10. Make sure that the **Activate after save** check box is selected if you want to enable the server connection immediately.
11. Click **Create**. The target Service Manager server appears in the list of connected servers.
12. If you have SM 9.34 or higher, perform the following additional steps:
 - a. Reopen the Service Manager connected server that you configured in the previous steps. To do so, double-click the connected server entry in the connected servers list.
 - b. Copy the ID of the connected server and save it. You must specify this ID as `omi.mgr.id` on the Service Manager system.

An example of a connected server ID is as follows:

ID: 22f42836-fd36-473e-afc9-a81290f4f73b

Step 2: (optional) Configure an Event Forwarding Rule

Once you have configured the Service Manager server as a connected server in OMi, you can forward events manually by using **Transfer Control To** from the Context Menu. If you want to automatically forward events, you can configure an Event Forwarding Rule for the OMi server.

1. Open the Event Forwarding manager:

Administration > Event Processing > Automation > Event Forwarding

2. In the **Event Forwarding Rules** pane, click the  **New Item** button to open the **Create New Event Forwarding Rules** dialog box.

3. Enter a display name, and (optional) a description of the event forwarding rule being specified.
4. Select **Active**. A rule must be active in order for its status to be available in Service Manager.
5. Select an event filter for the event forwarding rule from the **Events Filter** list. The filter determines which events to consider for forwarding.

Filters for Event Forwarding Rules can screen events based on the following date-related event attributes which, for example, help you to ignore outdated events:

- o Time Created
 - o Time Received
 - o Time Lifecycle State Changed
4. If no appropriate filter is already configured, create a new filter as follows:
 - a. Click the  **New Item** button to open the **Filter Configuration** dialog box. You can choose between New Simple Filter or New Advanced Filter.
 - b. In the **Display Name** field, enter a name for the new filter, in this example, FilterCritical.
Clear the check boxes for all severity levels except for the severity Critical.
Click **OK**.
 - c. You should see your new filter in the Select an Event Filter dialog box (select it, if it is not already highlighted).
Click **OK**.
 6. Under **Target Servers**, select the target server you configured in the previous step on connecting servers. Click the **Add** button next to the target servers selection field. You can now see the connected server's details. In the **Forwarding Type** field, select the **Synchronize and Transfer Control** forwarding type. Although other selections are technically possible, only Synchronize and Transfer Control is supported by Service Manager.

Step 3: Configure the OMi integration in Service Manager

Service Manager can integrate with more than one OMi server. To configure more than one server, first complete ["Configure the Instance Count in the Service Manager-OMi integration template" on the next page](#) before adding integration instances. To proceed with the default of one server, skip to ["Add an SMOMi integration instance for each OMi server" on the next page](#).

Configure the Instance Count in the Service Manager-OMi integration template

To integrate Service Manager with more than one OMi server, configure the Instance Count setting in the SMOMi integration template, as described below.

1. Log on to Service Manager as a system administrator.
2. Type `db` in the command line, and press Enter.
3. In the **Table** field, type `SMISRegistry`, and click **Search**.

The SMIS integration template form opens.

4. Click **Search**.

A list of SMIS integration templates opens.

5. Select **SMOMi** from the list.
6. In the **Instance Count** field, change the value of 1 to the number of OMi servers that you want to integrate with Service Manager. For example, if you need two OMi servers, change the value to 2.
7. Click **Save**.

Add an SMOMi integration instance for each OMi server

Once you have completed configuration in OMi, you are ready to add and enable a separate integration instance in Service Manager for each OMi server.

To add and enable an Incident Exchange (OMi - SM) integration instance:

1. Log on to Service Manager as a system administrator.
2. Click **Tailoring > Integration Manager**.
3. Click **Add**.

The Integration Template Selection wizard opens.

4. Select **SMOMi** from the Integration Template list.

Note: Ignore the **Import Mapping** check box, which has no effect on this integration.

5. Click **Next**.
6. Complete the integration instance information:

- Modify the **Name** and **Version** fields to the exact values you need.
 - In the **Interval Time (s)** field, enter a value. For example: 600. If an OMi opened incident fails to be synchronized back to OMi, Service Manager will retry the failed task at the specified interval (for example, 600 seconds).
 - In the **Max Retry Times** field, enter a value. For example: 10. This is the maximum allowed number of retries for each failed task.
 - (Optional) In the **SM Server** field, specify a display name for the Service Manager server host. For example: my_Local_SM.
 - (Optional) In the **Endpoint Server** field, specify a display name for the OMi server host. For example: my_OMi_1.
 - (Optional) In the **Log File Directory** field, specify a directory where log files of the integration will be stored. This must be a directory that already exists on the Service Manager server host.
 - (Optional) In the **Log Level** field, change the log level from INFO (default) to another level. For example: **WARNING**.
 - (Optional) If you want this integration instance to be automatically enabled when the Service Manager Server service is started, select **Run at system startup**.
7. Click **Next**. The Integration Instance Parameters page opens.
 8. On the **General Parameters** tab, complete the following fields as necessary:

Field	Sample Value	Description
omi.server.url	http://<servername>:opr-gateway/rest/synchronization/event/	This is the URL address of the OMi server's RESTful web service. Replace <servername> with the fully qualified domain name of your OMi server.
http.conn.timeout	30	The HTTP connection timeout setting in seconds. Note: The out-of-box value is 30 (seconds), and 15 (seconds) is used if this field is empty.
http.rec.timeout	30	The HTTP receive timeout setting in seconds. Note: The out-of-box

Field	Sample Value	Description
		value is 30 (seconds), and 15 (seconds) is used if this field is empty.
http.send.timeout	30	The HTTP send timeout setting in seconds. Note: The out-of-box value is 30 (seconds), and 15 (seconds) is used if this field is empty.
sm.mgr.id	55436DBE-F81E-4799-BA05-65DE9404343B	The Universally Unique Identifier (UUID) automatically generated for this instance of Service Manager. Note: This field is automatically completed each time when you add an SMOMi integration instance. Do not change it, otherwise the integration will not work properly.
omi.reference.prefix	urn:x-hp:2009:opr:	The prefix of the BDM External Process Reference field, which will be present in incoming synchronization requests from the OMi server. Note: This field is automatically completed and has a fixed value. Do not change it.
sm.reference.prefix	urn:x-hp:2009:sm:	The prefix of the BDM External Process Reference field, which will be present in outgoing synchronization requests from Service Manager. Note: This field is

Field	Sample Value	Description
		automatically completed and has a fixed value. Do not change it.
omi.eventdetail.baseurl	http://<servername>/opr-console/opr-evt-details.jsp?eventId=	The basic URL address of the event detail page in OMi. Replace <servername> with the fully qualified domain name of your OMi server.

9. On the **General Parameters** and **Secure Parameters** tabs, enter three parameter values that you specified when configuring the Service Manager server as a connected server in OMi. The following table lists the parameters, whose values you can copy from your OMi server.

To copy the parameter values from OMi, follow these steps:

- a. Log in to OMi as a system administrator.
- b. Navigate to **Administration > Setup and Maintenance > Connected Servers**.
- c. Locate your Service Manager server configuration entry and double-click it.
- d. In the General section, copy the **ID** string into the **omi.mgr.id** field in Service Manager.
- e. In the Incoming Connection section, copy the User name and Password to the username and Password fields in Service Manager, respectively.

Field	Sample Value	Description
omi.mgr.id (on the General Parameters tab)	f3832ff4-a6b9-4228-9fed-b79105afa3e4	<p>The Universally Unique Identifier (UUID) automatically generated in OMi for the target Service Manager server.</p> <p>Note: This parameter was introduced to support multiple OMi servers. Service Manager uses the UUID to identify from which OMi server an incident was opened. Be aware that if you delete the connected server configuration for the Service Manager server in OMi and then recreate the same configuration, OMi generates a new UUID. You must reconfigure the integration instance by changing the old UUID to the new one.</p> <p>Tip: If you have only one OMi server, you can simply remove this parameter (remove both the parameter name and value) from the integration instance.</p>

Field	Sample Value	Description
username omi.mgr.id (on the General Parameters tab)	SM_Server	This is the user name that the Service Manager server uses to synchronize incident changes back to the OMi server.
Password (on the Secure Parameters tab)	SM_Server_Password	This is the password that the Service Manager server uses to synchronize incident changes back to the OMi server.

- Click **Next** twice, and then click **Finish**.

Note: Leave the Integration Instance Mapping and Integration Instance Fields settings blank. This integration does not use these settings.

Service Manager creates the instance. You can edit, enable, disable, or delete it in Integration Manager.

- Enable the integration instance.
- If you have multiple OMi servers, repeat the steps above for the rest of your OMi servers.

Step 4: Configure Launch of Service Manager Incident Details from OMi

If you want to be able to drill down to Service Manager incidents from the OMi Event Browser, you must configure the Service Manager web tier in the **sm:ServiceManagerAdapter** script in OMi.

- Navigate to Connected Servers in OMi:

Administration > Setup and Maintenance > Connected Servers

Click  **Manage Scripts**.

- Select the **sm:ServiceManagerAdapter** script, and click the **Edit Item** button.
- Click the **Script** tab and locate the following text in the Groovy script:

```
private static final String SM_WEB_TIER_NAME = 'webtier-9.30'
```

4. Change the value of `webtier-9.30` to the value required to access the Service Manager web tier client.

The drill-down URL is made up like this:

```
http://<FQDN of Service Manager web tier server>/<web path to Service  
Manager>/<URL query parameters>
```

In this instance, *<FQDN of Service Manager web tier server>* is the fully qualified DNS name of the Service Manager server where the web tier client is installed. This part of the URL is added automatically (together with `http://` or `https://`) according to the values that you provided when you configured Service Manager as a target connected server in the Connected Servers manager. The address of the Event Drilldown section of the Connected Server makes up the rest of the URL. For details, see the previous step on connecting servers.

An example of a drill-down URL:

```
http://smserver.example.com/SM930/index.do?ctx=docEngine&file=probsummary&query  
=number%3D%22IM10216%22&queryHash=bf52f465
```

In this example, you must replace `webtier-9.30` with `SM930`. All the other parts of the URL are configured automatically.

5. When finished editing, save the new version of the script. Note that the script can always be reverted to its original version.

For details, see the *OMi Administration Guide*.

6. If you are using SM 9.34 or lower, set the values of the `querysecurity` parameter and the `querySecurity Web` parameter from the default values (`true`) to `false` in the SM web tier configuration file `web.xml`.

For details about the `querysecurity` parameter and the `querySecurity Web` parameter, see Service Manager Online Help.

(optional) Step 5: Attribute Synchronization

Attribute Synchronization Using Groovy Scripts

When the SM incident is initially created from an OMi event, event attributes are mapped to the corresponding SM incident attribute. Out of the box, after the initial incident creation, whenever the

incident or event subsequently changes, only a subset of the changed event and incident attributes are synchronized. The following describes how to customize the list of attributes to synchronize upon change. If you want to change the out-of-the-box behavior regarding which attributes are updated, you can specify this in the Groovy script used on the OMi side for synchronization or incident creation. In the Groovy script, you can specify which fields are updated in SM, and which fields are updated in OMi. You can also specify custom attributes in the Groovy script.

Bidirectional Synchronization of Attributes

Individual OMi event attributes can be synchronized from an OMi event to the corresponding SM incident, whenever the event is changed in OMi. Similarly, individual SM incident attributes can be synchronized from an SM incident to the corresponding event in OMi, every time the event is changed in SM. To change the attributes that are synchronized from an OMi event to a corresponding SM incident, change the attributes included in the `SyncOPRPropertiesToSM` list in the Groovy script. To change the attributes that are synchronized from an SM incident to an OMi event, change the attributes included in the `SyncSMPPropertiesToOPR` list in the Groovy script. By default, the `state`, `solution`, and `cause` attributes are synchronized from OMi events to their corresponding SM incidents, and the `incident_status` and `solution` attributes are synchronized from an SM incident to the corresponding OMi event.

To enable synchronization of all attributes in both directions, you can set the `SyncAllProperties` variable to `true`. In this case, all other variables will be ignored.

Example:

- `private static final Set SyncOPRPropertiesToSM = ["state", "solution", "cause"]`
- `private static final Set SyncSMPPropertiesToOPR = ["incident_status", "solution"]`

The following table lists the OMi event attributes that can be synchronized with an SM incident, and the matching SM incident attributes that can be synchronized with an OMi event:

OMi event attribute	SM incident attribute
title	name
description	description
state	incident_status
severity	urgency
priority	priority
solution	solution

Unidirectional Synchronization of Attributes

The `assigned_user`, `assigned_group`, and `cause` event properties can be synchronized from an OMi event to a corresponding SM incident. To synchronize these attributes, add them to the `SyncOPRPropertiesToSM` list in the groovy script.

Example:

- `private static final Set SyncOPRPropertiesToSM = ["assigned_user", "assigned_group", "cause"]`

Individual OMi event properties can be synchronized to a corresponding SM incident Activity Log. Updates are not synchronized back from the SM incident Activity Log to the corresponding OMi event. To change the properties that are synchronized, add the desired properties to the `SyncOPRPropertiesToSMActivityLog` list in the Groovy script. By default, the `title`, `description`, `state`, `severity`, `priority`, `annotation`, `duplicate_count`, `cause`, `symptom`, `assigned_user`, and `assigned_group` properties are synchronized.

Example:

- `private static final Set SyncOPRPropertiesToSMActivityLog = ["title", "description", "priority"]`

The following list includes all properties that can be synchronized from OMi events to the SM incident Activity Log:

- `title`
- `description`
- `state`
- `severity`
- `priority`
- `solution`
- `annotation`
- `duplicate_count`
- `assigned_user`
- `assigned_group`
- `cause`
- `symptom`

- control_transferred_to
- time_state_changed

Custom Mappings for Custom Attributes

You can define your own mappings for custom attributes between OMi and SM. These mapping can be either unidirectional, if the attributes are only contained in one map, or bidirectional, if the attributes are contained in both maps. To create custom mappings for custom attributes, you can edit the `MapSM2OPRCustomAttribute` and `MapOPR2SMCustomAttribute` lists in the Groovy script. These maps are empty by default.

Example:

- ```
private static final Map <String, String> MapSM2OPRCustomAttribute =
 ["MySMAttribute" : "MyOMiCustomAttribute"]
```
- ```
private static final Map <String, String> MapOPR2SMCustomAttribute = [
    "MyOtherOMiCustomAttribute" : "MyOtherSMAttribute", "MyThirndOMiCA", "activity_
    log"]
```

Mapping OPR Lifecycle States to BDM Lifecycle States

Individual OPR event state and SM incident status changes may be selected for synchronization. Out of the box, only the "closed" state is synchronized in both directions. To change this behavior, add the desired states to the appropriate list, `SyncOPRStatesToSM` or `SyncSMStatusToOPR`.

Examples:

- ```
private static final Set SyncOPRStatesToSM = ["closed", "in_progress",
 "resolved"]
```
- ```
private static final Set SyncSMStatusToOPR = ["closed", "resolved"]
```

In the example, the OPR event lifecycle states `closed`, `in_progress`, and `resolved` are synchronized to the SM incident status, and SM incident statuses `closed` and `resolved` are synchronized to the OPR event state.

Note: The special state "*" denotes all states, so to synchronize all OPR event states to the SM incident status property, specify the following:

```
private static final Set SyncOPRStatesToSM = ["*"]
```

Additionally, two maps are used to specify the mapping of the OPR event lifecycle state to the BDM incident status. The maps are named `MapOPR2SMStatus` and `MapSM2OPRState`. Out of the box, all possible states have a mapping.

Examples:

- ```
private static final Map MapOPR2SMStatus = ["open": "open", "in_progress":
"work-in-progress", "resolved": "resolved", "closed": "closed"]
```
- ```
private static final Map MapSM2OPRState = ["accepted": "open", "assigned":
"open", "open": "open", "reopened": "open",
"pending-change": "in_progress", "pending-customer": "in_progress", "pending-
other": "in_progress",
"pending-vendor": "in_progress", "referred": "in_progress", "suspended": "in_
progress",
"work-in-progress": "in_progress", "rejected": "resolved", "replaced-problem":
"resolved",
"resolved": "resolved", "cancelled": "resolved", "closed": "closed"]
```

Tips for customizing Groovy Scripts

This section provides some tips about customizing Groovy scripts. It contains a few selected examples of what you can customize. To see further items that can be modified, see the configuration section of a Groovy script.

In the configuration section of the Groovy script, you can define and modify the attributes that are to be synchronized between OMi and SM. The configuration section of the Groovy script also contains the default value mappings for lifecycle state, severity, and priority. You can also modify these, and it is possible to define the mappings for in-going and out-going requests differently.

More advanced configuration can be done in other parts of the Groovy script if required.

The beginning and the end of the configuration section of the Groovy script is marked as follows:

```
//
//*BEGIN Configuration: Customization of properties for synchronization*
//
...
...
```

```
//  
// *END Configuration: Customization of properties for synchronization*  
//
```

Note: Modifications to Groovy scripts are not overwritten by patches and hotfixes. Your customized version of a script will remain after an update or a patch. If you want to use the newer version of a script, make a copy of your version, revert back to the predefined version, and then reapply your changes.

The mapping from OMi to SM is compliant to BDM 1.1 incident web service specifications. The mapping of the BDM 1.1 incident web service to SM is specified in SM in the BDM Mapping Manager. For more information about the BDM Mapping Manager, see Service Manager Online Help.

Avoiding Errors with Large TQL Queries

If the Groovy script executes a TQL query that produces a large number of results, an error message appears informing you about the TQL query result exceeding the size limit. As a consequence, the integration event is not sent. It is possible, however, to increase this limit by modifying the value of the `tql.compound.link.max.visited.objects` setting.

Note: To check the default value of the `tql.compound.link.max.visited.objects` setting, from the JMX console, select **UCMDB:service=Settings Services**, and then locate the **showSettingsByCategory** method and enter **TQL Settings** as the category name.

To modify the value of the `tql.compound.link.max.visited.objects` setting, follow these steps:

1. From the JMX console, select **UCMDB:service=Settings Services**.
2. Click **setSettingValue**.
3. Enter `tql.compound.link.max.visited.objects` as the name of the setting you want to modify and a new value for it.

Caution: Increasing the value of the `tql.compound.link.max.visited.objects` setting also increases the load on the RTSM. Therefore, make sure to carefully consider how much to increase this value.

Syntax Errors

The `ServiceManagerAdapter` Groovy script uses the Apache Wink client to communicate with Service Manager. It therefore will throw a `ClientWebException` when there is an HTTP error status

returned by Service Manager.

If you get a syntax error when customizing your Groovy scripts, you will get an event in the event browser with a detailed description of the error. In addition, you may view the `opr-event-sync-adapter.log` log file for information about how to resolve the error. You can find this log file at the following location:

```
<Gateway Server root directory>/log/opr-scripting-host/opr-event-sync-adapter.log
```

Step 6: Test the Event Forwarding and Cross Launches

To test the event forwarding, forward an event manually to SM and then verify that the event is forwarded to SM as expected, and that the cross launches work in both directions.

1. Open an OMi **Event Browser**.
2. Select an event and select **Transfer Control To** in the Context Menu. Select the SM target system.
3. Select the **Forwarding** tab.
4. In the External Id field, you should see a valid SM incident ID after a few seconds.
5. Verify that the incident appears in the Incident Details in Service Manager by using the cross launch (see next step).

If the event drill-down connection is not configured, verify the forwarding by using the following:

- a. In the Forwarding tab in the OMi Event Browser, copy or note the incident ID from the External Id field.
 - b. In the Service Manager user interface, navigate to:
Incident Management > Search Incidents
 - c. Paste or enter the incident ID in the Incident Id field.
 - d. Click the **Search** button. This takes you to the incident in the Incident Details.
6. Test the cross launch from OMi to SM:

Click the hyperlink created with the incident ID. A browser window opens, which takes you directly to the incident in the Incident Details in Service Manager.
 7. Test the cross launch from SM to OMi:

In the Incident Details in Service Manager, click **More** and then select **View OMi Event**. A browser window opens, which takes you directly to the event in the Event Browser in OMi.

Note: The **View OMi Event** option displays only when the **omi.mgr.id** parameter in the corresponding SM-OMi integration instance is set correctly.

8. Close the incident in Service Manager.
9. Verify that the change in the state of the incident (it is now `closed`) is synchronized back to OMi. You may not be able to see the event that was closed in SM in the active Event Browser, but it should now be in the Closed Events Browser.

Advanced Configuration

Configure forwarding of affected business services from OMi to SM

Service Manager versions 9.40 and higher support the display of multiple affected business services associated with an event in OMi. By default, when an event is created in OMi that affects more than one business service CI, all affected services are automatically forwarded to SM. The most critical service is displayed on the "Primary Service" tab in SM, and all other affected services are displayed on the "Impacted Services" tab.

If you only want to forward the most critical affected service associated with an event from OMi to SM, you can change the `ForwardAllAffectedBusinessServices` flag in the **sm:ServiceManagerAdapter** script to `false`.

1. Navigate to **Connected Servers** in OMi:

Administration > Setup and Maintenance > Connected Servers

Click  **Manage Scripts**.

2. Select the **sm:ServiceManagerAdapter** script, and click the **Edit Item** button.
3. Click the **Script** tab and search for `ForwardAllAffectedBusinessServices`. Change the value to `false`.
4. When finished editing, save the new version of the script. Note that the script can always be reverted to its original version. For details, see the *OMi Administration Guide*.

Configure automatic closure for OMi incidents in SM

Incidents created from OMi events will be automatically closed when the corresponding OMi event is closed. You can also configure SM incidents created from OMi events to be automatically closed after a predefined amount of time since they were last updated (or resolved if they have not been updated after being resolved).

The workflow is as follows:

1. An incident is opened from OMi.
2. If the **Schedule Condition** is met, the system creates a schedule record for the incident. The schedule record will expire at a future time based on the **Calc Expression**.
3. A user updates the incident and saves the changes.
4. The **Reset alerts if** expression on the **Alerts** tab of the **probsummary** object definition is evaluated. If it evaluates to true, the Expiration time of the schedule record is updated based on the Calc Expression. By default, the expiration time of the schedule record is updated only when the incident has a category of **incident**.
5. When the schedule record expires, the **Alert Condition** is evaluated. If it evaluates to true, the incident is automatically closed.

To enable automatic closure for OMi incidents:

1. Configure the global settings in the Incident Management Environment record.
 - a. In SM versions lower than 9.40, click **System Administration > Ongoing Maintenance > Environment Records > Incident Management Environment**.

In SM versions 9.40 and higher, click **Incident Management > Administration > Environment**.
 - b. Change the following settings as necessary.

Field	Value
Close Incident Automatically?	<p>This option disables or enables the automatic closure of OMi incidents at the global level.</p> <ul style="list-style-type: none"> • If this option is not selected, no incidents will be automatically closed. • If this option is selected, incidents will be automatically closed under specified conditions. <p>Default: Not selected</p>

Field	Value
Closure Code	This value will be copied to the Closure Code field of incidents when they are automatically closed. Default: Automatically Closed
Solution	This description will be appended to the end of the Solution field of incidents when they are automatically closed. Default: This incident which belongs to OMi has been closed automatically.

- c. Click **Save**.
- d. Restart the Service Manager server.

Note: If you have made any changes to any of the configuration options in the Incident Management Environment record, the Service Manager server must be restarted for the changes to take effect.

2. Configure the alert definition that determines when an incident should be closed.

Note: The **alert** and **problem** processes must be running to enable the successful closure of OMi incidents.

- a. Click **Tailoring > Document Engine > Alerts**.
- b. In the Alert Name field, enter: **OMi Auto-Close**.
- c. Click **Search**. The OMiAuto-Close alert definition detail form opens.

Caution: These fields in the alert definition are used to control automatic closure of OMi incidents. You can change the default values of these fields. However, you must be aware of the risk that automatic closure of OMi incidents will not work properly if the **Schedule Condition** and **Alert Condition** fields are not configured correctly.

Field	Value
Schedule Condition	This expression is used to determine if an incident should be scheduled for automatic closure. Default: <code>jscall("SMOMi.isAutoCloseAndResolved")</code> . An incident is scheduled for automatic closure when the following conditions are met. <ul style="list-style-type: none"> • The Close Incident Automatically? option in the Incident Management Environment record is selected. • In the incident record, the Do not close this incident automatically option is not selected.

Field	Value
	<ul style="list-style-type: none"> The incident has a status of Resolved.
Alert Condition	<p>This expression is evaluated when an incident is about to be automatically closed. If it evaluates to true, the incident is closed. Default: <code>jscall("SMOMi.isAutoCloseEnabled")</code>.</p> <p>An incident is closed when the following conditions are met.</p> <ul style="list-style-type: none"> The Close Incident Automatically? option in the Incident Management Environment record is selected. In the incident record, the Do not close this incident automatically option is not selected.
Calc Expression	<p>This expression is used to determine how much time will elapse before an incident is automatically closed.</p> <p>Default: <code>\$L.alert.time=update.time in \$L.file+'7 00:00:00'</code>.</p> <p>The default value means the amount of time elapsed is equal to seven days since the incident was last updated.</p>

3. Configure alert information in the **probsummary** object.

The OMi autoclose alert definition is configured to only be used by OMi incidents. The closure time is reset each time the incident is updated. If the closure time is reached without the incident being updated then Service Manager will automatically close the incident.

- a. Click **Tailoring > Document Engine > Objects**.
- b. In the **File name** field, enter **probsummary** and press ENTER. The **probsummary** object definition is displayed.
- c. Select the **Alerts** tab.

The **Reset alerts if** expression is used to reset the automatic closure time of OMi incidents.

Default: `category in $L.file="incident" and not null(1 in external.process.reference in $L.file)`.

Configure TLS for the Incident Exchange integration

When OMi is configured to accept https connections only, you must configure TLS for the integration. If you do not do so, changes on an incident that is created from OMi cannot be synchronized back to OMi.

Note: The following steps describe how you do so by using the built-in keytool in Service Manager, and the file paths are for Windows only. Be sure to change the file paths accordingly if your Service Manager system is running on Unix.

To configure TLS for the integration, follow these steps:

1. Import the OMi root certificate to the Service Manager server trusted keystore.

The following is an example of the command line:

```
<SM Install path>\server\RUN\jre\bin\keytool -import -alias myCA -file <.pem  
file of your BSM root certificate> -keystore <SM Install  
path>\Server\RUN\jre\lib\security\cacerts -storepass <changeit>
```

Note: Where: *changeit* is the default password of the trusted keystore. Change it to your own password if you have changed it.

2. Add the following parameters to the Service Manager server configuration file (<SM install path>\Server\RUN\sm.ini):

```
truststoreFile:<SM install path>\Server\RUN\jre\lib\security\cacerts  
truststorePass:<changeit>
```

3. Restart the Service Manager Server service.

Downtime Forwarding from Service Manager to OMi (UCMDB)

You can create downtimes (also known as outages) in OMi based on Requests for Changes (RFCs) in SM. This is done in two steps. First, scheduled downtime CIs are created in the UCMDB based on RFCs in SM. Then, a BSM downtime CI is created in OMi based on the scheduled downtime.

You can also send downtime start and end information from OMi to SM to notify operators of when a downtime occurs, especially if the downtime was not driven by an RFC in SM. For more information on this integration, see ["Sending downtime notifications from OMi to SM \(UCMDB\)" on page 210](#)

Notes:

1. For Changes/Tasks that have final approval phases defined in Service Manager Integration Suite (SMIS), the downtimes will be synchronized after the Changes/Tasks get final approval.
2. Only downtimes that end at a future time will be synchronized.
3. Select the **Configuration Item(s) Down** checkbox when scheduling downtimes in

Changes/Tasks.

4. The SLA scheduler needs to be started in the **System Status** form.

Step 1: Add an SMBSM_DOWNTIME integration instance in SM

To set up the integration from Service Manager to OMi, you must add an instance of this integration in the Service Manager Integration Suite (SMIS). Note that additional setup is required on the OMi side for integration from OMi to Service Manager.

To add the SMBSM_DOWNTIME instance:

1. Click **Tailoring > Integration Manager**. Integration Instance Manager opens.
2. Click **Add**. The Integration Template Selection wizard opens.
3. Select **SMBSM_DOWNTIME** from the Integration Template list. Ignore the **Import Mapping** check box, which has no effect on this integration.
4. Click **Next**. The Integration Instance Information page opens.
5. Do the following:
 - o Modify the **Name** and **Version** fields to the exact values you need.
 - o In the **Interval Time(s)** field, enter a value based on your business needs in regard to downtime exchange frequency. Note that a short interval time can be safe because the next scheduled task will not start until the previous task is completed and the interval time passed.
 - o In the **Max Retry Times** field, enter a value. This is the maximum allowed number of retries (for example, 10) for each failed task.
 - o In the **Log File Directory** field, specify a directory where log files of the integration will be stored. This must be a directory that already exists on the Service Manager server. By default, logging message is output to `sm.log`.
 - o (Optional) In the **SM Server** field, specify a display name for the Service Manager server host. For example: `my_local_SM`.
 - o (Optional) In the **Endpoint Server** field, specify a display name for the OMi server host. For example: `my_BSM_1`.
 - o (Optional) In the **Log Level** field, change the log level from INFO (default) to another level. For example: WARNING.

- (Optional) If you want this integration instance to be automatically enabled when the Service Manager Server service is started, select **Run at system startup**.
6. Click **Next**. The Integration Instance Parameters page opens.
 7. On the **General Parameters** tab, complete the following fields as necessary:

Name	Category	Value	Description
WithdrawDowntime	General	true/false	<p>Set this value to <code>true</code>: When authorized users are manually changing the phase of a change record which has 'valid' outage, a window will open and provide choices of withdrawing the outage.</p> <p>Set this value to <code>false</code>: The pop-up window is disabled. This operation may cause some unapproved planned downtimes be synchronized to OMi.</p> <p>By default, this value is set to <code>true</code>.</p>
Category or workflow (Process Designer) name of changes	Change	The final approval phase for changes	Set the final approval phase for downtime, which is the indication of valid downtime information.
Category or workflow (Process Designer) name of tasks	Task	The final approval phase for tasks	Set the final approval phase for downtime, which is the indication of valid downtime information.
sm.host	General	<sm server name >	<p>Set the Service Manager server host name or DNS name to compose the External Process Reference and the Reference Number of Scheduled Downtime CI in UCMDB.</p> <p>Note: Do not include a colon in this field. Otherwise, the logic will be broken.</p>
sm.reference.prefix	General	urn:x-hp:2009:sm	<p>Set the prefix to compose the External Process Reference of Scheduled Downtime CI in UCMDB.</p> <p>Note: This field has a fixed value. Do not change it.</p>

Notes:

- a. Type category or workflow name of change/task in the **Name** column. This value is case-sensitive and it must match the record in Service Manager database.
 - b. Set the value to Change for changes in the **Category** column. Similarly, set the value to Task for tasks.
 - c. Type the final approval phase in the **Value** column. This value is case-sensitive and it must match the record in Service Manager database. You can separate multiple phases by semicolons, which must be the English character.
 - d. Detailed information will be displayed in the integration log when the following errors occur:
 - User input of categories/phases for the changes/tasks is not correct.
 - The category and phase pair does not exist in the database.
 - e. For Change Management categories which do not have approval phase, the downtime integration will treat its downtime information as final approved once created. You do not need to define any phases in SMIS parameters.
 - f. For the category or workflow name of the changes and the tasks, the integration will ignore all the final phases defined for the redundant category or workflow.
8. Click **Next** twice and then click **Finish**. Leave the Integration Instance Mapping and Integration Instance Fields settings blank. This integration does not use these settings.
- Service Manager creates the instance. You can edit, enable, disable, or delete it in Integration Manager.
9. Enable the integration instance. SMIS will validate all the final phases you filled in the Integration Instance Parameters page and print warning messages if there are errors.

Step 2: Tailor Service Manager to handle phase change

In the Service Manager Change Management module, authorized users can manually change the phase of a change record. If the phase is changed to the one prior to the final approval phase in the SMBSM_DOWNTIME instance, the system will check if there are existing planned downtimes that have been set to Ready. If such downtimes exist, a window will open and provide two options for the corresponding planned downtimes:

- Click **Yes** to withdraw the corresponding planned downtimes from UCMDB. The changes or tasks need to be approved again to synchronize with UCMDB at another time.
- Click **No**. There will be no change to the planned downtimes even if the actual status of the changes or tasks are not approved.

Note: To disable the pop-up window when withdrawing the planned downtimes, you must set the `WithdrawDowntime` parameter to `false` in the `SMBSM_DOWNTIME` instance. This operation may cause some unapproved planned downtimes to be synchronized to OMi.

With Process Designer (PD) Content Pack 2 applied in Service Manager, you can tailor the process to transit changes or tasks from one phase that is after the final approval phase in the `SMBSM_DOWNTIME` instance to another that is prior to the final approval phase. To withdraw the related planned downtime for this kind of transition, you must add a rule set for the transition in the Closed Loop Incident Process (CLIP) solution. Follow these steps:

1. Go to the target workflow that needs tailoring.
2. Select the transition that moves a phase from before the final approval phase to after the final approval phase.
3. In the Rule Sets section, click **Add** and select the **clip.downtime.withdraw** rule set.
4. Click **OK** to save the workflow.

Step 3: Set up downtime sync jobs in UCMDB

As part of CI synchronization, you have already set up an integration point between SM and UCMDB. In this step, you add downtime synchronization jobs, so that scheduled downtime CIs are created in UCMDB based on Requests for Change in SM.

To add the downtime synchronization jobs:

1. Log in to your UCMDB system as an administrator.
2. Edit the existing integration point that connects to your Service Manager server.
3. Click **Managers > Data Flow Management > Integration Studio**. UCMDB displays a list of integration points.
4. Select the existing SM integration point. Make sure that CIs have already been synchronized between SM and UCMDB.
5. Create two integration jobs in the integration point on the **Population** tab:

- a. Create a new job including the **SM CLIP Down Time Population** job definition. Under **Scheduler Definition**, select the **Scheduler enabled** checkbox and set the Repeat Interval to 1 Minute. Click **OK** to save the job.
- b. Create another new job including the **SM CI Connection Downtime CI** job definition. Under **Scheduler Definition**, select the **Scheduler enabled** checkbox and set the Repeat Interval to 1 Minute. Click **OK** to save the job.

Pay attention to the running order. The **CLIP Down Time Population** job must be run first. You can set the two jobs as schedule-based and set the schedule interval according to your needs.

Note: If no related CIs exist in UCMDB when creating relationships, the population will fail or succeed with a warning. To disable the warning, remove the downtime CI that does not have related CIs in UCMDB.

Step 4: Set up creation of BSM Downtime CIs

In this step, BSM Downtime CIs are created based on Scheduled Downtime CIs.

To enable downtimes defined in SM to be sent to OMi, you must install the DFP2 in the OMi deployment.

Important:

- Following the initial integration, a large amount of data may be communicated from SM to OMi. It is highly recommended that you perform this procedure during off-hours, to prevent negative impact on system performance.

To create BSM Downtime CIs:

1. Create a new Integration Point or, if existing, edit the **SM Scheduled Downtime Integration Into BSM** Integration Point:
 - a. Do the following on your UCMDB:

Go to:

Managers > Data Flow Management > Integration Studio
 - b. Click **New Integration Point** or **Edit**, enter a name and description of your choice, and select the adapter **SM Scheduled Downtime Integration Into BSM** from the Service Manager folder.

If you have upgraded from an older version of OMi to OMi 10.10, you may still see the old "BSM Downtime Adapter", or you may see the "SM Scheduled Downtime Integration Into BSM" adapter in the Third Party Products folder (not in the Service Manager folder). In this case, you must upgrade your adapter by doing the following:

- i. Open the Package Manager.
 - ii. Deploy the package: `/opt/hp/BSM/odb/conf/factory_packages/BSMDowntimeAdapter.zip` on the data processing server.
 - iii. You should now find the **SM Scheduled Downtime Integration Into BSM** adapter in the Service Manager folder.
- c. Enter the following information for the adapter: OMi GW or Load Balancer/Reverse Proxy FDQN and port (80/443), communication protocol (http/https), and the context root (if you have a non-default context root).
 - d. Specify the credentials for the user you created in ["Create User Accounts for the OMi-SM Integration \(UCMDB\)" on page 168](#) to access the OMi system. Choose generic protocol as protocol.
 - e. Click **OK**, then click the **Save** button above the list of the integration points.
2. You can use the **Statistics** tab in the lower pane to track the number of downtimes that are created or updated. By default, the integration job runs every minute. If a job has failed, you can open the **Query Status** tab and double-click the failed job to see more details on the error.

If there is an authentication error, verify the OMi credentials entered for the integration point.

If you receive an unclear error message with error code, this generally indicates a communication problem. Check the communication with OMi.

A failed job will be repeated until the problem is fixed.

Step 5: Verify the SM-OMi downtime synchronization setup

When you have set up the Downtime integration, you can perform the following tasks to see if you have successfully set up your downtime synchronization.

Task 1. Open a new change of a category that has the final approval phase defined in SMIS

1. Click **Change Management > Create New Change**.
2. Select **Hardware** for example.
3. In the Affected CI field, choose a CI that has been synchronized. For example: adv-afr-desk-101.
4. Set Scheduled Downtime Start and Scheduled Downtime End to a future time.
5. Select the **Configuration Item(s) Down** checkbox.
6. Set other required fields.
7. Click **Validation Accepted**. If you are prompted to fill in more required fields, supply the required information and click Validation Accepted again.
8. Click **Request Authorization**.
9. Click **Save&Exit** the change.

Task 2. Approve the change at the final approval phase

1. Click **Change Management > Task Queue**.
2. Search for the task that was created in Task 1 and click **Close** to close the task.
3. Click **Change Management > Search Change** and search for the change opened in Task 1.
4. Move the Change to the Change Approval phase by selecting **Request Authorization**.
5. Log on to Service Manager with user account Change.Approver.
6. Select **Approval Inbox** and search for the change created in Task 1.
7. Approve the change.

Task 3. Create new format for the intClipDownTime table

1. Open the SM Windows client.

Note: This step can only be performed in the SM Windows client.

2. Enter **fd** into the search field to open the Forms Designer and click New.
3. Create a new format for the intClipDownTime table by using the Form Wizard.
4. Add all fields to this format.

Task 4. Check the corresponding intClipDownTime record

1. From Database Manager, open the format of the intClipDownTime table.
2. Click **Search** to see the record created for this downtime.
3. Check the External Status field:

External Status values	Description
NULL	The downtime is waiting for final approval, or the scheduler has not proceeded this record yet.
0 (Canceled)	The downtime is canceled before being implemented.
1 (Ready)	The downtime has been approved and is ready to be synchronized to UCMDB or BSM (RTSM).
2 (Withdrawn)	The downtime is approved firstly and then the approval is retracted (withdrawn).

Notes:

- a. Only downtime records with External Status 1 can be synchronized.
- b. If the External Status is not 1, wait some time for background schedulers SLA and SMBSM_DOWNTIME to process this record.

Task 5. Populate downtime from Service Manager to UCMDB

1. From UCMDB, run the CLIP Down Time Population job and the CI To Down Time CI With Connection job in a fixed order.
2. Search for the adv-afr-desk-101 CI in UCMDB. Check that a corresponding Scheduled Downtime CI is created, and a relationship between the Scheduled Downtime CI and the affected CI is created.

Task 6. Test if BSM Downtime CIs have been created

1. In OMi, go to **Administration > Service Health > Downtime Management**.
2. Check if a corresponding Downtime was created.

Sending downtime notifications from OMi to SM (UCMDB)

OMi can send downtime start and end events to SM to notify operators of when a downtime occurs. This provides additional information to the SM operator in case of a downtime that was not driven by an RFC.

To create downtimes in OMi based on RFCs in SM, see ["Downtime Forwarding from Service Manager to OMi \(UCMDB\)" on page 201](#).

Step 1: Send OMi Downtime Events to SM

To enable OMi to send downtime start and end events to SM, follow these steps:

1. Access the following location in OMi:

Administration > Setup and Maintenance > Infrastructure Settings > Foundations > Downtime

2. Change the value of the **Downtime Send Event** parameter to **true**.
3. Restart your OMi services on all Gateway Servers and Data Processing Servers.

This procedure generates events in OMi. After performing it, make sure you edit and enable the **Automatically forward "downtime started" and "downtime ended" events to Trouble Ticket System** event forwarding rule to forward downtime-start and downtime-end events to the SM server that should be specified in the alias connected server called "Trouble Ticket System". For details on event forwarding and connected servers, see the *OMi Administration Guide*.

Downtime events use the following formats:

- **Downtime Start**

Event field	OMi Downtime
Severity	Normal
Category	Downtime Notification
Title	Downtime for <CI Type><Affected CI Name>started at <Downtime Start Time>
Key	<OMi Downtime ID>:<Affected CI ID>:downtime-start
SubmitCloseKey	False
OutageStartTime	<Downtime Start Time>
OutageEndTime	<Downtime End Time>
CiName	<Affected CI Name>
Ciid	<Affected CI Global ID>
CiHint	GUCMDB:<Affected CI Global ID> UCMDB:<Affected CI ID>
HostHint	GUCMDB:<Related Host Global ID> UCMDB:<Related Host ID>
EtiHint	downtime:start

- **Downtime End**

Event field	OMi Downtime
Severity	Normal
Category	Downtime Notification
Title	Downtime for <CI Type><Affected CI Name> ended at < Downtime End Time>
Key	<OMi Downtime ID>:<Affected CI ID>:downtime-stop
SubmitCloseKey	true
CloseKeyPattern	<OMi Downtime ID>:<Affected CI ID>:downtime-start
EtiHint	downtime:end
LogOnly	true

View Changes and Incidents in OMi (UCMDB)

This integration enables you to view planned changes and incident details in the Changes and Incidents and Hierarchy components in OMi.

This chapter includes the following:

- ["Prerequisite" below](#)
- ["Step 1: Configure the Service Manager Adapter Time Zone" on the next page](#)
- ["Step 2: Create an Integration Point in OMi" on the next page](#)
- ["Step 3: Edit Integration TQLs " on page 214](#)
- ["Step 4: Verify View changes and incidents" on page 215](#)
- ["How to Customize the Changes and Incidents Component" on page 216](#)

Prerequisite

This integration requires that CIs are synchronized between UCMDB and SM. For information on CI synchronization, see ["Operations Manager i - Service Manager Integration Overview" on page 93](#).

Out-of-the-box, OMi provides queries that are used to retrieve changes and incidents from SM. These queries need to be manually deployed to your UCMDB. On the OMi data processing server, go to <OMi_Home>/odb/conf/factory_packages and find the Console.zip package. Copy the package to

the local directory on your UCMDB system and use the UCMDB Package Manager to deploy the `console.zip` package to the UCMDB.

This integration requires an administrator user account for OMi to connect to SM. This user account must already exist in both OMi and SM. For details on creating required user accounts, see ["Create User Accounts for the OMi-SM Integration \(UCMDB\)" on page 168](#)

Step 1: Configure the Service Manager Adapter Time Zone

Configure the time zone so Incidents and Planned Changes have the correct time definitions:

1. In SM, select **Navigation pane > Menu navigation > System Administration > Base System Configuration > Miscellaneous > System Information Record**. Open the **Data Info** tab.
2. In the **Date Info** tab, look up the value for the Time Zone.
3. In OMi, select **Administration > RTSM Administration > Data Flow Management > Adapter Management**.
4. In the **Resources** window, open **ServiceManagerAdapter9-x > Configuration Files > ServiceManagerAdapter9-x/serviceDeskConfiguration.xml**

Find the row that includes the following string:

```
<globalConnectorConfig><![CDATA[<global_configuration><date_pattern>MM/dd/yy  
HH:mm:ss</date_pattern><time_zone>US/MOUNTAIN</time_zone>
```

Check the date and time format, as well as a time zone. Note that the date is case-sensitive. Change either SM or the `xml` file so that they both match each other's settings.

Note: Specify a time zone from the Java time zone list that matches the time zone used in SM (for example, `America/New York`).

5. If you changed the time zone on SM, restart the SM server; if you changed the time zone on OMi, you do not need to restart the OMi server.)

Step 2: Create an Integration Point in OMi

To create an integration point, follow these steps:

1. In OMi, select **Administration > RTSM Administration > Data Flow Management > Integration Studio**.
2. In the Integration Point pane, select **Create New Integration Point** or choose an existing integration point to edit. The Create New Integration Point dialog box opens. Enter the following:

Name	Recommended Value	Description
Integration Name	SM Integration	The name you give to the integration point.
Adapter	<user defined>	Select Software Products > Service Manager > Service Manager 9.xx . This adapter, which supports CI/ relationship Data Push from RTSM to Service Manager, and Population and Federation from Service Manager to RTSM.
Is Integration Activated	selected	Select this check box to create an active integration point.
Hostname/IP	<user defined>	The name of the SM server.
Port	<user defined>	The port through which you access SM.
Credentials ID	<user defined>	Click Generic Protocol , click the Add button to add the integration user account you created in " Create User Accounts for the OMi-SM Integration (UCMDB) " on page 168 and then select it.
Probe Name (for ServiceManagerAdapter9-x only)	<user defined>	Select the probe that you installed for this integration.

Note: It is recommended to click the **Test Connection** button to verify that the details entered are working before continuing.

3. In the **Integration Point** pane, click the Integration Point you just created, and click the **Federation** tab in the right pane.
4. In the **Supported and Selected CI Types** area, verify that **Incident** and **RequestForChange** are selected.

Step 3: Edit Integration TQLs

In this step, edit the integration TQLs so that they use the Integration Point created in the previous step.

1. In OMi, select **Administration > RTSM Administration > Modeling > Modeling Studio**.
2. On the **Resources** tab, select Resource Type: Queries. Open the **Console** folder.
3. Open the TQL: `CollectRequestForChangeWithImpacts`.
4. In the **Query Definition** pane, right click one of the objects of CI Type: `RequestForChange`.
5. From its Context Menu, select **Set Integration Points**. Choose the Integration Point that you configured in the previous step.
6. Repeat steps 4 and 5 for all objects of CI Type: `RequestForChange`.
7. Open the TQL: `CollectRequestForChangeWithoutImpacts`.
8. Repeat steps 4 and 5 for all objects of CI Type: `RequestForChange`.
9. Open the TQL: `CollectTicketsWithImpacts`.
10. In the **Query Definition** pane, right click one of the objects of CI Type: `Incident`.
11. From its Context Menu, select **Set Integration Points**. Choose the Integration Point that you configured in the previous step.
12. Repeat steps 10 and 11 for all objects of CI Type: `Incident`.
13. Open the TQL: `CollectTicketsWithoutImpacts`.
14. Repeat steps 10 and 11 for all objects of CI Type: `Incident`.
15. Save all TQLs.

Step 4: Verify View changes and incidents

To verify that you can view changes and incidents in OMi, make sure that you have an incident in SM that is related to a CI in the OMi RTSM. To do so, send a test event related to a CI that has been synchronized between OMi and SM.

1. Send an event, for example, by using the following command:

```
submitEvent -t testViewIncidents -rch <hintForExistingCI>
```
2. Select the event in the OMi Event Browser and select **Transfer Control To** in the Context Menu. Select the SM target system.
3. Open the 360° View and select a view containing the related CI.
4. Select the CI, and verify that the **Incident Count** is at least 1. Click **Incidents** to show the Changes in Incidents window, and verify that the incident is displayed in the Incidents section.

By default, the Changes and Incidents component displays data for the previous week. You can change this setting to previous week, day, or hour (up to the current time) by using the Configure Component button.

How to Customize the Changes and Incidents Component

By default, incidents and requests for change are displayed for the following CI types: Business Service, Siebel Application, Business Application, and Node. If you want to view change and incident information for other CITs, perform the following procedure:

1. Open the Modeling Studio:

Administration > RTSM Administration > Modeling > Modeling Studio

Copy one of the TQLs within the **Console** folder, and save your copy with a new name. These default TQLs perform the following:

TQL name	Description
CollectTicketsWithImpacts	Retrieves SM incidents for the selected CI, and for its child CIs which have an Impact relationship.
CollectTicketsWithoutImpacts	Retrieves SM incidents for the selected CI.
CollectRequestForChangeWithImpacts	Retrieves SM requests for change, for the selected CI, and for its child CIs which have an Impact relationship.
CollectRequestForChangeWithoutImpacts	Retrieves SM requests for change, for the selected CI.

2. Edit the new TQL as needed. You can add CITs as described in ["Naming Constraints for New Request for Change TQLs" on the next page.](#)

3. Open Infrastructure Settings:

Administration > Setup and Maintenance > Infrastructure Settings

- a. Select **Applications**.
- b. Select **Service Health Application**.
- c. In the **Service Health Application - Hierarchy (360) properties** area, enter the name of the new TQL you created in the corresponding infrastructure setting.

Note: By default, these infrastructure settings contain the default TQL names. If you enter a TQL name that does not exist, the default value will be used instead.

After you modify the infrastructure setting, the new TQL will be used, and the Changes and Incidents component will show this information for the CITs you defined.

Naming Constraints for New Request for Change TQLs

The following naming constraints must be followed in the request for change *without* impact TQL (see the TQL example below, on the right side of the image):

- The request for change CI type must start with **directPlannedChange**.
- The CI type related to the request for change must start with **trigger**.

The following naming constraints must be followed in the request for change *with* impact TQL (see the TQL example below, on the left side of the image):

- **impacterPlannedChange** represents the request for change CI type.
- The CI type related to the request for change must start with **impacter**.
- **triggerTUUniverse** represents the "impacted" child CIs.

Examples of request for change TQLs:

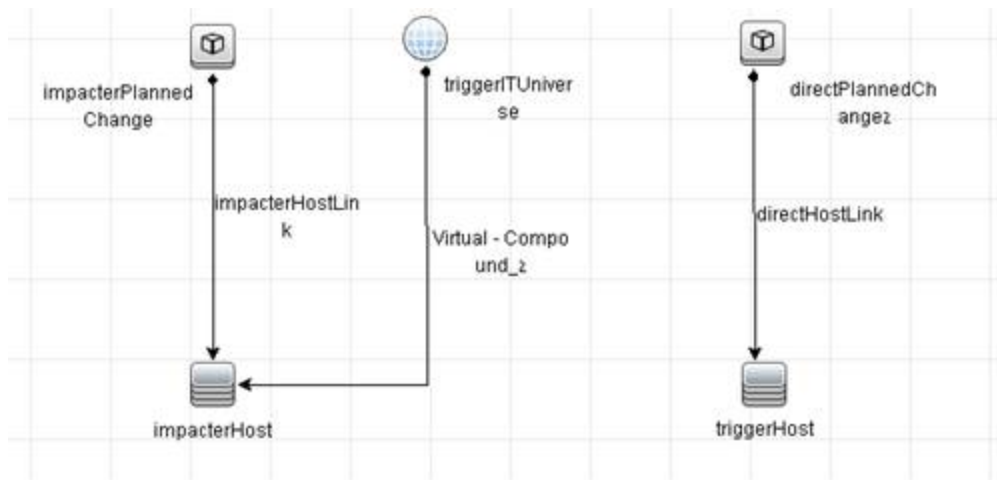

Naming Constraints for New Incident TQLs

The following naming constraints must be followed in the incidents *without* impact TQL (see the TQL example below, on the right side of the image):

- The incident CI type must start with **directTIincident**.
- The CI type related to the incident must start with **trigger**.

The following naming constraints must be followed in the incidents *with* impact TQL (see the TQL example below, on the left side of the image):

- **impacterTIincident** represents the incident CI type.
- The CI type related to the incident must start with **impacter**.
- **triggerTIUniverse** represents the "impacted" child CIs.

Examples of incident TQLs:

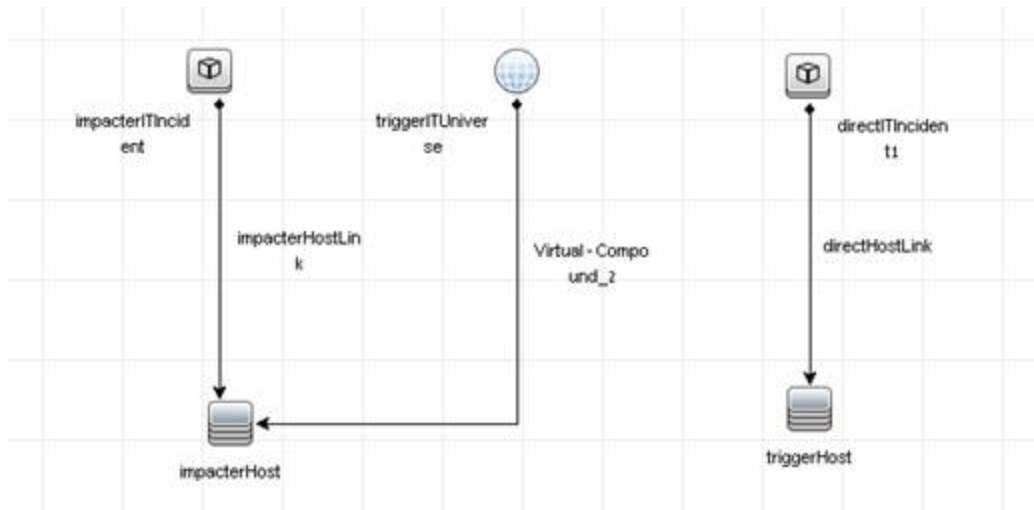

Business Impact Report (BIR) (UCMDB)

OMi includes a report that you can use to help evaluate the impact of incidents on your business. For example, if a host CI has critical status, you can use the report to display the status of the Business Service CIs to which the host CI is attached.

Incident Management users can launch an impact report from an incident in context with the incident's affected configuration item (CI). Service Desk Agents can validate the updated status of the business impact to categorize and prioritize the incident accordingly.

Note:

- This integration requires that CIs are synchronized between both Service Manager and OMi.
- Only one instance of this integration is allowed.

Step 1: Add a Business Impact Report Integration in SM

To use the Service Manager to BIR integration, you must add and enable an instance of this integration in Integration Manager.

To add and enable a Service Manager to BIR integration instance:

1. Click **Tailoring > Integration Manager**. Integration Instance Manager opens.
2. Click **Add**. The Integration Template Selection wizard opens.
3. Select **SMBIR** from the Integration Template list. Ignore the **Import Mapping** check box, which has no effect on this integration.

Note: Only one instance of this integration is allowed. If an instance of this integration already exists in Integration Manager, the **SMBIR** template is unavailable. You have to delete the existing integration instance before you can add a new one.

4. Click **Next**. The Integration Instance Information page opens.
5. Update the following fields:

Note: Only **Name** and **Version** are required fields. This integration does not use the **Interval Time (s)** and **Max Retry Times** fields as it is UI-based.

Field	Value
Name	(Required) The name of the integration instance. Default: SMBIR
Version	(Required) The version of the integration template. Default: 1.0
SM Server	The name of the Service Manager server machine.

Field	Value
Endpoint Server	The name of the OMi Server machine.
Log Level	Select one from: DEBUG, INFO (default), WARNING, ERROR, and OFF.
Log File Directory	A directory on the Service Manager Server machine in which log files will be stored.
Description	If you want, modify the default description of the instance.
Run at system startup	Select this check box only if you want this instance to be automatically enabled when the Service Manager Server is started.

6. Click **Next**. The Integration Instance Parameters page opens.
7. On the **General Parameters** tab, replace "BSM_host" in the **baseurl** parameter with the hostname of the real OMi server.
8. Click **Next** twice and then click **Finish**. Leave the Integration Instance Mapping and Integration Instance Fields settings blank. This integration does not use these settings.

Service Manager creates the instance. You can edit, enable, disable, or delete it in Integration Manager.

9. Enable the integration instance.



Step 2: Launch a Business Impact Report from an Incident

To launch a Business Impact Report from an incident:

1. Log on to the Service Manager Web client.
2. From **Incident Management**, search for an incident record and open it.
3. Click **More** and then select **Launch Business Impact Report**. The OMi Business Impact window opens, showing the KPI over time data for the related CI and related business services.

Customizing the Service Manager Integration

The ServiceManagerAdapter groovy script is provided for Event Forwarding to Service Manager. You can customize this script for your installations.

To customize the ServiceManagerAdapter groovy script, open the Scripts manager () , select the **sm:ServiceManagerAdapter** script and open it for editing (). The Edit Script window opens. The contents of the script are displayed in the **Script** tab.

Tip: Copying the script text into a text editor of your choice. When you have finished editing, copy the edited text back to the Edit Script window and save the script.

Near the beginning of the script, there are two sections used to modify the default behavior of the OMi event synchronization with Service Manager.

To access

Administration > Setup and Maintenance > Connected Servers

Click the  button.

Configuring the ServiceManagerAdapter Script

This section controls which event and incident properties are synchronized to and from Service Manager, and is contained within the following comments:

- BEGIN Configuration: Customization of properties for synchronization
- END Configuration: Customization of properties for synchronization

The ServiceManagerAdapter script can be configured section contains constants, 6 "maps" and "8" sets to allow configuring the synchronization of the properties. Each is described below:

Service Manager Drilldown Constant

The first variable that can be adjusted is `SM_WEB_TIER_NAME`. Set this value to the base name of the web application deployed in the Tomcat container on the Service Manager system. This web application is used for drilling down into Service Manager. The name is used in the URL path for the drill

down. It must match the base name of the web application (".war" is removed). The default is shown below:

```
private static final String SM_WEB_TIER_NAME = 'webtier-9.30'
```

OMi Administrator User

The `BSM_ADMINISTRATOR_LOGIN_NAME` variable is used to contain the name of the OMi Administrator user. By default this is set to `admin`.

For the events that are forwarded automatically by a forwarding rule, the `_is_recorded_by` attribute is set to the user specified in the `BSM_ADMINISTRATOR_LOGIN_NAME` variable.

For the events that are forwarded manually, the `_recorded_by` attribute is set to the user that initiated the forward request.

```
private static final String BSM_ADMINISTRATOR_LOGIN_NAME = 'admin'
```

Enumeration Value Maps

Maps are defined to map enumerated values of the event properties to values on Service Manager incident properties. These maps, in general, may not be customized, but they provide a list of possible values that can be specified in the sets described below. For details on each map, view the actual values defined in the script.

- **MapOPR2SMStatus:** Maps the event state to the Service Manager incident status
- **MapSM2OPRState:** Maps the Service Manager incident status to the event state
- **MapOPR2SMUrgency:** Maps the event severity to the Service Manager incident urgency
- **MapSM2OPRSeverity:** Maps the Service Manager incident urgency to the event severity
- **MapOPR2SMPriority:** Maps the event priority to the Service Manager incident priority
- **MapSM2OPRPriority:** Maps the Service Manager incident priority to the event priority

Custom Property Maps

The following maps allow a user to map any top-level event property to any top-level Service Manager incident property.

- **MapOPR2SMCustomAttribute:** Maps the specified custom attributes to a Service Manager incident property for synchronization.

Add a CA name to the map along with a Service Manager incident property name (XML tag name).

Target Service Manager Incident property name of "activity_log" will append the CA change to the Service Manager incident activity log.

Note: Only top-level Service Manager incident properties are supported in this map.

- **MapSM2OPRCustomAttribute:** Maps the specified Service Manager incident properties to an event custom attribute for synchronization.

Add a Service Manager incident property name to the map along with an event custom attribute name.

Note: Only top-level Service Manager incident properties are supported in this map.

Examples:

The following synchronizes the event custom attribute `MyCustomCA` to the Service Manager incident `activity_log` and the custom attribute `MyCustomCA1` to the Service Manager incident property `SMCustomAttribute`.

```
private static final Map<String, String> MapOPR2SMCustomAttribute =
["MyCustomCA" : "activity_log", "MyCustomCA1" : "SMCustomAttribute"]
```

The following synchronizes the Service Manager incident property `incident_status` to the custom attribute `SMIncidentStatus`.

```
private static final Map<String, String> MapSM2OPRCustomAttribute = ["incident_
status" : "SMIncidentStatus"]
```

Synchronization Change Sets

The following sets define which properties and enumerated values are synchronized whenever a change occurs in the OMi event or Service Manager incident. The properties synchronized upon a change as standard are marked in **bold**. For each list, the value of "*" can be specified. In this case, all possible properties or enumerated values are synchronized for the specified list.

Note: When the Service Manager incident is created, all possible event properties and enumerated values are set in the Service Manager incident. The following sets are mainly used for synchronization of changes.

SyncOPRPropertiesToSM

Event properties to synchronize to a corresponding Service Manager Incident property on change:

- title
- **description**
- **state**
- severity
- priority
- **solution**
- assigned_user
- assigned_group

SyncOPRPropertiesToSMActivityLog

Event properties to synchronize to a corresponding Service Manager Incident activity log on change:

- **title**
- description
- **state**
- **severity**
- **priority**
- solution
- **annotation**
- **duplicate_count**
- **custom_attribute**
- **cause**
- **symptom**
- control_transferred_to
- **assigned_user**
- **assigned_group**

SyncSMPropertiesToOPR

Service Manager Incident properties to synchronize to a corresponding event property on change:

- name
- **description**
- **incident_status**
- urgency
- priority
- **solution**

SyncOPRStatesToSM

Event states to synchronize to the Service Manager incident status on change:

Note: state must be included in SyncOPRPropertiesToSM or this list is ignored.

- open
- in_progress
- in_progress
- resolved
- **closed**

SyncOPRSeveritiesToSM

Event severities to synchronize to the Service Manager incident urgency on change:

Note: severity must be included in SyncOPRPropertiesToSM or this list is ignored.

- **critical**
- **major**
- **minor**
- **warning**
- **normal**
- **unknown**

SyncSMSStatusToOPR

Service Manager incident status to synchronize to the event states on change:

Note: status must be included in `SyncSMPropertiesToOPR` or this list is ignored.

- accepted
- assigned
- open
- reopened
- pending-change
- pending-customer
- pending-other
- pending-vendor
- referred
- suspended
- work-in-progress
- rejected
- replaced-problem
- resolved
- cancelled
- **closed**

SyncSMUrgenciesToOPR

Service Manager incident urgencies to synchronize to the event severities on change:

Note: urgency must be included in `SyncSMPropertiesToOPR` or this list is ignored.

Acceptable values are **1-4**.

SyncSMPrioritiesToOPR

Service Manager incident priorities to synchronize to the event priorities on change:

Note: priority must be included in `SyncSMPPropertiesToOPR` or this list is ignored.

Acceptable values are **1-4**.

Examples:

The following example synchronizes the OMi title, state and description to the Service Manager incident whenever the corresponding property is changed in the OMi event.

```
private static final Set SyncOPRPropertiesToSM = ["title", "state", "description"]
```

The following example will synchronize the OMi states resolved and closed to the Service Manager incident whenever the corresponding property is changed in the OMi event.

```
private static final Set SyncOPRStatesToSM = ["resolved", "closed"]
```

Note: The properties that are synchronized to the Service Manager activity log are concatenated together for each change and then appended to the Service Manager incident activity log.

Localization

This section is provided to enable localizing some of the text that is displayed in the:

- The Event Browser **Forwarding** tab (not available for an Event Channel deployment)
- Service Manager incident activity log

This sections is contained within the following comments:

- `BEGIN Localization:` Customization of text values for language localization
- `END Localization:` Customization of text values for language localization

The following sections describe the text that can be localized.

Forwarding tab

The Service Manager incident properties urgency and priority are of type integer. In order to display a more meaningful value in the Forwarding tab, maps are provided to display a string. These strings may be localized for display in the browser.

- **Service Manager Urgency values**

The text value will be displayed on the **Forwarding** tab.

Note: This text may be localized for the desired locale.

```
private static final Map SMUrgency = ["1": "1 - Critical", "2": "2 - High", "3":
"3 - Average", "4": "4 - Low"]
```

- **Service Manager Priority values**

The text value will be displayed on the **Forwarding** tab.

Note: This text may be localized for the desired locale.

```
private static final Map SMPriority = ["1": "1 - Critical", "2": "2 - High", "3":
"3 - Average", "4": "4 - Low"]
```

Service Manager Incident Activity Log

Synchronization from OMi to Service Manager appends various text to the Service Manager incident activity log. This text may be localized as follows.

- **General Locale Setting:** Used mainly in formatting of dates. May be changed, for example to `Locale.JAPAN`. See Java *Locale* class documentation for all possible values.

```
private static final Locale LOCALE = Locale.getDefault()
```

- **Annotation date format:** See Java *SimpleDateFormat* class documentation for details on the syntax. Script default is below.

```
private static final String ANNOTATION_DATE_FORMAT = "yyyy.MM.dd HH:mm:ss z"
```

- **Description:** In Service Manager the incident description is a required attribute. In case it is not set in OMi this value is taken. An empty string is NOT allowed.

```
private static final String EMPTY_DESCRIPTION_OVERRIDE = "<none>"
```

- **Log Text:** The following text is prefixed to the appropriate event property when synchronizing it to an Service Manager Incident activity log.

NOTE: This text may be localized for the desired locale. Defaults are as shown below.

```
private static final String ACTIVITY_LOG_TITLE = "[Title]\n"
```

```
private static final String ACTIVITY_LOG_TITLE_CHANGE = "Event title changed to:
"
```

```
private static final String ACTIVITY_LOG_STATE = "[State]\n"
```

```
private static final String ACTIVITY_LOG_STATE_CHANGE = "Event state changed to:
"

private static final String ACTIVITY_LOG_DESCRIPTION = "[Description]\n"

private static final String ACTIVITY_LOG_DESCRIPTION_CHANGE = "Event description
changed to: "

private static final String ACTIVITY_LOG_SOLUTION = "[Solution]\n"

private static final String ACTIVITY_LOG_SOLUTION_CHANGE = "Event solution
changed to: "

private static final String ACTIVITY_LOG_ASSIGNED_USER = "[Assigned User]\n"

private static final String ACTIVITY_LOG_ASSIGNED_USER_CHANGE = "Event assigned
user changed to: "

private static final String ACTIVITY_LOG_ASSIGNED_GROUP = "[Assigned Group]\n"

private static final String ACTIVITY_LOG_ASSIGNED_GROUP_CHANGE = "Event assigned
group changed to: "

private static final String ACTIVITY_LOG_SEVERITY = "[Severity]\n"

private static final String ACTIVITY_LOG_SEVERITY_CHANGE = "Event severity
changed to: "

private static final String ACTIVITY_LOG_PRIORITY = "[Priority]\n"

private static final String ACTIVITY_LOG_PRIORITY_CHANGE = "Event priority
changed to: "

private static final String ACTIVITY_LOG_CONTROL_TRANSFERRED_TO = "[Control
Transferred To]\n"

private static final String ACTIVITY_LOG_CONTROL_TRANSFERRED_TO_CHANGED = "Event
control transfer state changed to: "

private static final String ACTIVITY_LOG_ANNOTATION = "[Annotation]\n"

private static final String ACTIVITY_LOG_CA = "[Custom Attribute]\n"

private static final String ACTIVITY_LOG_CAUSE = "[Cause] "

private static final String ACTIVITY_LOG_OMI_CAUSE = "[OMi Cause] "

private static final String ACTIVITY_LOG_OMI_SYMPTOM = "[OMi Symptom] "

private static final String ACTIVITY_LOG_DUPLICATE_COUNT = "[Duplicate Count] "
```

```
private static final String ACTIVITY_LOG_PREVIOUS = "previous "
private static final String ACTIVITY_LOG_CURRENT = "current "
```

Mapping Table: OMi Event to BDM Incident Property

The standard integration synchronizes the following OMi Event properties to Service Manager Incident properties:

OMi UI (Event)	OMi UI (Forwarding)	OMi Web Service (Event)	Service Manager Web Service (Incident)	Service Manager Object	Service Manager UI	Comments
-	-	-	global_id	id	-	There is no mapping and no synchronization for global_id between an OMi event and a Service Manager incident.
ID	-	id	external_process_reference	external.processes.reference	-	Set only on Service Manager incident creation.
-	External ID	control_transferred_to_external_id	reference_number	number	Incident ID	Set only on Service Manager incident creation.
Title	-	title	name	brief.description	Title	Set on incident creation. Standard configuration: only the OMi title changes are synchronized

OMi UI (Event)	OMi UI (Forwarding)	OMi Web Service (Event)	Service Manager Web Service (Incident)	Service Manager Object	Service Manager UI	Comments
						to the Service Manager incident activity log. If the event title exceeds 256 characters, or contains a newline character, it is truncated and the entire title is prepended to the description.
Description	-	description	description	action	Description	Can be a combination of the OMi event title and description. See title comments for details. Standard configuration: synchronized in both directions.
Solution	-	solution	solution	Resolution	Solution	Standard configuration: synchronized in both directions.
Lifecycle State	-	state	incident_status	problem.status	Status	Set on incident creation. Standard configuration: only 'closed' state is synchronized.

OMi UI (Event)	OMi UI (Forwarding)	OMi Web Service (Event)	Service Manager Web Service (Incident)	Service Manager Object	Service Manager UI	Comments
Severity	Severity	severity	urgency	severity	Urgency	Set on incident creation. Standard configuration: all value changes are synchronized.
Priority	Priority	priority	priority	priority.code	Priority	Set on incident creation. Standard configuration: all value changes are synchronized.
Assigned User	-	assigned_user_login_name	is_requested_by_party_display_label	contact.name	Contact	By default not synchronized.
-	Assigned User	-	has_assigned_party_display_label	assignee.name	Assignee	OMi queries the Service Manager Incident Web Service in real time for display in Forwarding Tab only. No synchronization between the OMi event and the Service Manager incident.
-	-	control_transferred_to_initiated_by	is_recorded_by_party_display_label	opened.by	Opened By	By default not synchronized.

OMi UI (Event)	OMi UI (Forwarding)	OMi Web Service (Event)	Service Manager Web Service (Incident)	Service Manager Object	Service Manager UI	Comments
			label			
Assigned Group	Assigned Group	assigned_group name	has_assigned_group_functional_group_display_label	assignment	Assignment Group	OMi queries the Service Manager Incident Web Service in real time for display on the Forwarding tab only. No synchronization between the OMi event and the Service Manager incident.
Category	-	category	category	sub_category	Area	Category is set by OMi only on Service Manager incident creation, but is by default ignored in Service Manager.
Subcategory	-	sub_category	sub_category	product_type	Subarea	Subcategory is set by OMi only on Service Manager incident creation, but is by default ignored in Service Manager.
Related CI	-	related_ci	is_registere	logical.name	Affected CI	Affected CI is set by OMi

OMi UI (Event)	OMi UI (Forwarding)	OMi Web Service (Event)	Service Manager Web Service (Incident)	Service Manager Object	Service Manager UI	Comments
			d_for			only on Service Manager incident creation.
Annotations	-	annotation_list	activity_log_description	update.action	Activity Log	Synchronized from OMi to Service Manager only. OOTB synchronization enabled.
Custom Attributes	-	custom_attribute_list	activity_log_description	update.action	Activity Log	Can be configured for synchronization to a specific Service Manager incident property, or the activity log. For Service Manager activity log, synchronization is from OMi to Service Manager only. Standard configuration: synchronization disabled.
Cause	-	cause->control_transferred_to_external_id	is_caused_by-master_reference_number	Links the two SM Incidents	Related Records	If the cause event has been synchronized to Service Manager, the two Service

OMi UI (Event)	OMi UI (Forwarding)	OMi Web Service (Event)	Service Manager Web Service (Incident)	Service Manager Object	Service Manager UI	Comments
						Manager Incidents are related, otherwise information about the OMi cause is appended to the Service Manager incident activity log. Standard configuration: synchronization enabled.
Symptoms	-	symptom_list	activity_log description	update.action	Activity Log	Synchronization is from OMi to Service Manager only. Standard configuration: synchronization enabled.
Duplicate Count	-	duplicate_count	activity_log description	update.action	Activity Log	Synchronization is from OMi to Service Manager only. Standard configuration: synchronization enabled.

Part VI: Operations Manager i - Network Node Manager i Integration

Chapter 24: Operations Manager i - Network Node Manager i Integration Overview

Tip: The following is a high-level overview of the Operations Manager i - Network Node Manager i (NNMi) integration. You can find comprehensive details on NNMi integrations in the *Network Node Manager i Software—Business Service Management/Universal CMDB Topology Integration Guide*.

You can integrate NNMi with OMi to provide the following capabilities:

- **NNMi topology > OMi RTSM topology.** The topology integration populates the OMi RTSM with the NNMi network topology. OMi stores each device, interface, IP address, and a few other artifacts in the NNMi network topology as a CI and includes it in the relevant views.
- **NNMi events > OMi events.** NNMi events are displayed in the Event Browser in OMi. You can also access the NNMi console from the OMi Event Browser. The NNMi events are sent to OMi by using the Operations Connector.

This integration has item ID 344 in the Integrations Catalog at the following location:

<https://softwaresupport.hpe.com/km/KM01694988>

- **NNMi events > OMi health indicators.** After you have set up the integration, if the NNMi events have corresponding health indicators defined, these health indicators affect the status of relevant CIs in OMi applications, such as Service Health.
- **OMi > NNMi drill down.** In OMi, you can configure a link to the NNMi management server that enables you to drill down from My Workspace and other locations to NNMi, to view trace route information between the client and the destination machine. You can also use URL tools to launch a browser that enables you to connect to the NNMi management server and further analyze incoming events in NNMi.

In addition, certain NNMi user interface components (network maps, items, detailed information dialogs, and so on) can be displayed directly in **Workspaces > My Workspace**.

Note: If the NNMi topology is not synchronized with the OMi RTSM topology, the **Monitored by** property of the OMi CIs corresponding to the NNMi CIs is empty, and these CIs are not displayed in the System Monitors only Perspective, System Hardware Monitoring, and System Software Monitoring views.

Chapter 25: How to Integrate Network Node Manager i with Operations Manager i

This chapter describes how to integrate NNMi with OMi.

1. Prerequisite

Make sure you have the OMi and NNMi licenses installed. For details, see the *OMi Administration Guide*.

2. Perform the integration in NNMi

Perform the steps needed to integrate NNMi with OMi in the NNMi application.

For details, see the *Network Node Manager i Software—Business Service Management/Universal CMDB Topology Integration Guide*.

3. Configure LW-SSO in both OMi and NNMi

To be able to seamlessly switch between NNMi and OMi, it is recommended to use LW-SSO. Make sure that LW-SSO is configured in both OMi and NNMi with the same `initString`. For details on how to configure the `initString` in OMi, see the *OMi Administration Guide*. For details on how to configure the `initString` in NNMi, see the *NNMi Deployment Reference*.

It is also possible to integrate NNMi with OMi without using LW-SSO. In this case, you are prompted for a password every time you switch to an NNMi component.

4. Connect NNMi to more than one OMi instance

After connecting the first OMi instance to NNMi, NNMi stores in its own database the CI IDs gained from the topology synchronization of the OMi's RTSM. When another OMi instance is connected, another topology synchronization is carried out. As the OMi instances might contain some of the same CI IDs, the IDs need to be reconciled in the NNMi database. This reconciliation works only partially and the NNMi log files still include several reconciliation errors that are caused by the non-existing RTSM IDs. To fix the problem, perform the following steps:

- a. Change the integration to the new OMi system.
- b. Log on to the NNMi JMX console `http://<NNMi_fqdn_and_port>/jmx-console` using the

- system account and password.
- c. Go to **mbean NnmBsmModule**.
- d. Run **java.lang.String resetNnmBsmlDs()**.
You should see a list of devices from which the RTSM ID was removed.
- e. Disable and enable the topology integration to get the CIs into RTSM.

5. Configure OMi to display NNMI data

To display NNMI data in OMi and to access the NNMI components in **Workspaces > My Workspace**:

- a. Open Infrastructure Settings:
Administration > Setup and Maintenance > Infrastructure Settings
- b. Select **Foundations**.
- c. Select **Integrations with other applications**.
- d. In the **Integrations with other applications - HP NNM** table, locate and modify the following parameters:
 - **HP NNM Integration URL**. The NNMI host and port number (protocol://host:port/nnm).
 - **HP NNM UI drilldown use global CI ID**. Set to `true` if the NNMI topology integration is synchronized to a different RTSM or UCMDB.

6. Results

You can view NNMI data in **Workspaces > My Workspace**, as described in ["NNMI Components in My Workspace" on page 240](#).

Chapter 26: NNMi Components in My Workspace

If you set up an integration between NNMi and OMi, you can view the NNMi components described below in **Workspaces > My Workspace** as follows:

Note: Make sure you have a View Explorer component configured in addition to the new NNMi component. The View Explorer component pulls the node information needed by the NNMi component. For more information on the View Explorer component, see the *OMi User Guide*.

1. Click the **New Page** icon.
2. Click **Add Component**. The Component Gallery window opens.
3. In All Categories, select the **NNMi** check box.

To access the NNMi components, you must have the appropriate licenses installed. NNMi components are only displayed if you configured a connection to an NNMi server in Infrastructure Settings:

Administration > Setup and Maintenance > Infrastructure Settings

Select **Foundations > Integrations with other applications > HP NNM**.

Component Name	Description
Layer 2 Neighbor View	Shows a map view of a selected device and its connector devices within a specified number of hops from the selected device. This view is useful for understanding the switch connectivity between devices.
Layer 3 Neighbor View	Shows a map view of a selected device and its connector devices within a specified number of hops from the selected device. This view is useful for understanding the router connectivity between devices.
MPLS VPN Inventory	This is an enterprise customer view of how their sites are connected via service provided MPLS networks.
Open Key Incidents	Shows the incidents that are most important to network operators and that often require more immediate action.
Overall Network Health (Node Group)	Displays a map containing all (top-level) Node Groups that do not have parent Node Groups.

Component Name	Description
Overview)	
Overall Network Health - Routers	Displays a Node Group Map of the Router connectivity in your network.
Overall Network Health - Switches	Displays a Node Group map of the Switches connectivity in your network.
Router Redundancy Groups Inventory	Shows the available Router Redundancy Groups created by the NNMi administrator. Each Router Redundancy Group is a set of two or more routers that use one or more virtual IP addresses to help ensure that information packets reach their intended destination.

Part VII: Operations Manager i - Operations Orchestration Integration

Chapter 27: Operations Manager i - Operations Orchestration Integration Overview

HPE Operations Orchestration (OO) provides a simple way for customers to run scripts for automatic actions. The integration with OMi uses the OO capabilities for building investigation tools or service remediation scripts, providing the operators with a simple way to validate a problem, investigate it, or automatically correct it. A run book can be executed manually.

OO run books can be launched from the Service Health and Event Browser applications.

The integration of OMi and OO provides the capability of mapping CI types to OO run books.

After you create such mappings, you can run the mapped OO run books:

- **On CIs, by using the Invoke Run Books context menu option in Service Health.** The OO run book parameters are populated by using the map to the CI attributes defined in the Run Book Mapping Configuration wizard. For detailed information about the wizard, see the *OMi Administration Guide*.
- **At the event level.** OMi opens an event and checks if the CI for this event has a run book assigned to it, and if the run book is set to run automatically. The OO run book parameters are populated by using the map to the CI or event attributes defined in the Run Book Mapping Configuration wizard. For detailed information about the wizard, see the *OMi Administration Guide*.

Chapter 28: How to Integrate Operations Manager i and Operations Orchestration

This chapter describes how to integrate OMi and OO. Steps for integrating both a classic OMi deployment or OMi in a container deployment are described.

1. Prerequisites

Before you configure the integration, the OO administrator needs to perform the following:

- a. Enable user authentication and create an integration user with the **Administrator** role:
 - **OO version 10.02 or higher:** The user must be **internal**.
 - **OO 9.xx:** The user must be **external**.

Users must have the following capabilities in OO: AUTHOR, SCHEDULE, MANAGE_RUNS, RUN_REPORTS, and HEADLESS_FLOWS. You can either add users to groups with these capabilities (for example, the administrator group has these capabilities) or you can create such a group.

- b. Deploy the following OO Content Packs (CPs) on the OO server: **Base**, **Middleware**, and **Operating Systems**. For OO version 10.50 and higher, also deploy the **Third-party** content pack.

First deploy the **Base** CP, and then the other CPs.

For details on how to deploy CPs in OO, see the OO documentation.

Note: If you have upgraded to a newer OO version, you must also upgrade the OO Content Packs. For more information on Content Packs, see the HPOO documentation.

- c. If you want to configure run book automation in a set up with a load balancer and a firewall, ensure that port 8443 is open. If port 8443 is not open, the automatic run book execution will fail. The **Automatic Run Book Execution** is triggered from the data processing server.

2. Configure the link between OMi and OO

To configure the integration between OMi and OO, in OMi:

- a. Open Infrastructure Settings:

Administration > Setup and Maintenance > Infrastructure Settings

- b. Select **Foundations**.
- c. Select **Integrations with other applications**.
- d. In the **HPE Operations Orchestration** table, locate **Operations Orchestration application server version**. If you are using OO version 9.x, select OO 9, and if you are using OO version 10.x, select OO 10.
- e. Locate **Operations Orchestration application URL**, and modify the setting to the URL used to access the OO application.

When connecting an OMi instance that employs Lightweight Single Sign-On (LW-SSO) to **OO version 10.02 or higher**, you must specify the connection URL of OO using the following format: **<protocol>://<FQDN>:<portNumber>** (for example, http://lab.lab:8080). The port can be 8080 for HTTP or 8443 for HTTPS, according to your needs. For **OO 9.xx**, use: https://<fully qualified server name>:8443.

If you want to enable run books to be invoked automatically, you must enter a User Name and Password in the same table. In this case, the user should be defined as **internal** in OO.

- f. **OO 9.xx only:** To be able to invoke run books automatically, the user must be **internal**.

3. Configure LW-SSO authentication

Configure LW-SSO authentication between OMi and OO. You must configure LW-SSO in both OMi and OO. Proceed to the relevant section depending on your version of OO.

For OO version 9.05 or lower:

- a. Make sure Single Sign-On for OMi is enabled (it is disabled by default). In OMi, open Authentication Management:

Administration > Users > Authentication Management

In the Single Sign-On Configuration section, click  **Edit** to open Single Sign On Editor panel. If you are integrating OO with a classic (non-container) OMi deployment, select **Lightweight**. If you are integrating OO with OMi in a container environment, select **HPEIdentityManagement**.

Copy the **Token Creation Key (initString)** to OO, and replace, in OO, all the initStrings in the **lwssofmconf.xml** file located in the **<OO installation directory>\Program Files\Hewlett-Packard\Operations Orchestration\Central\conf** directory.

- b. In OO, in the **web.xml** and **applicationContext.xml** files located in the **<OO installation directory>\Program Files\Hewlett-Packard\Operations Orchestration\Central\WEB-INF** directory, enable all filters and mappings

between **LWSSO_SECTION_BEGIN** and **LWSSO_SECTION_END**.

- c. *Integration with OMi classic deployment only.* If OO and OMi are in different domains in the Windows operating system, you must make sure that the **Trusted Hosts/Domains** parameter is the same in OO and OMi. To set the parameter in OMi, open Authentication Management:

Administration > Users > Authentication Management

In the Single Sign-On Configuration section, click  **Edit** to open Single Sign On Editor panel. In the Single Sign On Editor panel, select **Lightweight**.

Configure the **Trusted Hosts/Domains** parameter in the field available when you select **Domain**

- d. Restart the following OO services:
- For OO version 9.02 or lower: **RSCentral**, **RSJRAS**, and **RSScheduler**.
 - For OO version 9.03, 9.04, or 9.05: **RSCentral** and **RSJRAS**.

Note: If you need to enable logging for debugging LW-SSO: In OO, in the **<OO installation directory>\jetty\resources\log4j.properties** file, uncomment the line that appears under the LW-SSO comment.

For OO version 9.06 or higher:

- a. Make sure Single Sign-On for OMi is enabled (it is disabled by default). In OMi, open Authentication Management:

Administration > Users > Authentication Management

- In the Single Sign-On Configuration section, click  **Edit** to open Single Sign On Editor panel.

If you are integrating OO with a classic (non-container) OMi deployment, select **Lightweight**. If you are integrating OO with OMi in a container environment, select **HPEIdentityManagement**.

- Copy the **Token Creation Key (initString)**.
 - Add the domain where your OMi and OO systems are located to the **Trusted Hosts/Domains** section.
 - Click **Save**.
- b. In OO, access the following:

- For OO version 10.20 or higher, select **System Configuration > Security > SSO**.
 - For OO version 10.02 or higher (except version 10.20), select **System Workspace > Security > SSO**.
 - For OO version 9.xx, select **Administration > System Configuration > Authentication**.
- c. For OO version 9.2x, select the **Enable Authentication** check box in the **LW SSO Settings** area.
- d. Replace the value of the **LW SSO** passphrase or the **InitString** parameter with the Token Creation Key you copied from OMi. (This must have the same value on all OMi instances that are integrated by using LW-SSO.)
- e. Define domain-related parameters in the **LW SSO Settings** area:
- **Domain.** The domain of the OO server.
 - *Integration with OMi classic deployment only.* **Protected Domains.** List of comma-separated domains used by the OMi instances that employ LW-SSO.

Note: If OO and OMi are in different domains in the Windows operating system, make sure that the **Trusted Hosts/Domains** parameter is the same in OO and OMi.

In OMi, open Authentication Management:

Administration > Users > Authentication Management

In the Single Sign-On Configuration section, click  **Edit** to open Single Sign On Editor panel. In the Single Sign On Editor panel, select **Lightweight**.

Configure the **Trusted Hosts/Domains** parameter in the field available when you select **Domain**

Note: Limitation with OO versions 10.02 to 10.22 and OMi

The OMi integration with the OO versions 10.02 to 10.22 (inclusive) is only supported if OO and OMi are in the same domain. If they are in different domains, the integration fails.

For further details on configuring LW-SSO in OO, see the OO documentation.

For further details on configuring LW-SSO or HPEIdentityManagement in OMi, see the *OMi Administration Guide*.

4. Export server certificates from OO

To export server certificates from OO and import them into OMi in a Windows or Linux

environment, use the **keytool** utility, which is included in JRaim.out-68

E.

For OO 9.xx:

a. On the OO server, enter:

- **Windows:**

```
[OO install folder]\jre1.6\bin\keytool -keystore "[OO install folder]\Central\conf\rc_
keystore" -export -alias pas -file "<path>\<Operations Orchestration fully qualified
host name>.cer"
```

- **Linux:**

```
keytool -keystore "$ICONCLUDE_HOME/Central/conf/rc_keystore" -export -alias
pas -file "<path>/<Operations Orchestration fully qualified host name>.cer"
```

b. When prompted for a password, enter bran507025.

For OO version 10.02 or higher

a. On the OO server, enter:

- **Windows:**

```
[OO install folder]\java\bin\keytool.exe -keystore "[OO install
folder]\central\var\security\key.store" -export -alias tomcat -file
"<path>\<Operations Orchestration fully qualified host name>.cer"
```

- **Linux:**

```
keytool -keystore "$ICONCLUDE_HOME/central/var/security/key.store" -export -
alias tomcat -file "<path>/<Operations Orchestration fully qualified host
name>.cer"
```

b. When prompted for a password, enter changeit.

5. *Integration with classic OMi deployment only.* Import OO server certificates to OMi

Import the server certificate from the OO server to the OMi Gateway Server so that the two systems can communicate with each other securely.

a. **Import the Server Certificate to OMi.** To import the server certificate you exported from OO to the OMi cacerts keystores, on the OMi Gateway Server:

Enter the following commands:

```
<OMi_HOME>\bin\opr-cert-mgmt.[bat|sh] -import <alias> <path>
```

Note: For more information on the `opr-cert-mgmt` tool, see *the OMi Extensibility Guide*.

- b. Restart all OMi servers so that the trust is loaded in the truststore.
- c. To prevent a certificate error, make sure that this certificate is imported as a trusted root certification authority on any browser that will be accessing OMi.

The procedure for importing the certificate may vary slightly depending on the type of browser that you are using. For example, if you are using Internet Explorer, follow these steps:

- i. Click **Tools > Internet Options > Content > Certificates**.
- ii. In the Trusted Root Certification Authorities tab, click the **Import...** button.
- iii. Click **Next** to start the Certificate Import Wizard.
- iv. Specify the file you want to import, and then click **Next**.
- v. Select the **Place all certificates in the following store** radio button, and then click **Browse**.
- vi. Select **Trusted Root Certification Authorities**, and then click **Next**.
- vii. Click **Finish**.

Note: Repeat the above steps on the Data Processing Server as well.

6. *Integration with OMi deployment in container only.* Import OO server certificates to OMi container

Import the server certificate from the OO server to the OMi container so that the two systems can communicate with each other securely.

- a. Find the name of the OMi container by running the following command:

```
kubectl get pods --all-namespaces
```

- b. Go into the OMi container, switch to the OMi directory, and create a certificate directory in the OMi container if you haven't already:

```
kubectl exec <OMi container name> -ti bash -c omi -n opsbridge1
```

```
cd/opt/HP/BSM/bin
```

```
mkdir /var/certs
```

- c. Copy the OO server certificate to the Docker host using a file transfer tool.

- d. Get the OMi container ID:

```
docker ps | grep omi
```

Then, copy the OO server certificate from the Docker host to the OMi container by using the ID:

```
docker cp <path to certificate>/<certificateName.cer> <OMi Container ID>:<path to certificate>/<certificateName.cer>
```

- e. Import the OO server certificate to the OMi container keystore:

```
kubect1 exec <OMi container name> -ti bash -c omi -n opsbridge1
```

```
cd /var/certs
```

```
/opt/HP/BSM/bin/opr-cert-mgmt.sh -import <alias> <path>
```

7. Grant permissions

Grant permissions so that users can create, view, and modify the mapping between OMi CI types and OO run books, and invoke OO run books from OMi.

To integrate with OO, you must set up users in OMi with specific permissions. Navigate to:

Administration > Users > Users, Groups, and Roles

Select the user or create a new user and grant them a role with **Operations Orchestration Integration** permissions.

When setting up the users, keep in mind the following:

- Set up an integration user with the same name in OMi and OO (for example, OMiOO_integr_user).

Note: The username in OO should have all lowercase letters. If users with the same username but different case sensitivity exist in OO, the lowercase username is used.

- In OMi, the user must have the following permissions to execute Run Books:
 - The **Operations Console > Run Book Execution** permission.
 - The **Advanced RTSM Permissions > Resources (tab) > Resource Type > Queries** permission.
 - The **Advanced RTSM Permissions > Resources (tab) > Resource Type > Views** permission.

- The **Advanced RTSM Permissions > General Actions (tab) > CI Related Actions** permission.
- The **Advanced RTSM Permissions > General Actions (tab) > Data Retrieval Actions** permission.
- To enable an OMi user to map a run book to the selected CI type, in OMi, the user must have the **Operations Console > Run Book Mappings** permission to administer Run Books.
- To enable an OMi user to administer Run Book Mappings and Automatic Run Book Execution pages in OMi, the user must be created on both OMi and OO, as described above. The same configuration and required permissions apply as for the integration user.

8. Map run books to CI Types

You can map OO run book parameters to:

- CI type attributes. For details on the user interface, see the *OMi Administration Guide*.

The child CIs of a CI, for which you configure a run book, are also assigned to that run book.

Note: To be able to map run books to CI types, either create a run book flow in OO, or import a content pack in OO with the Content Workspace.

- The event attributes are predefined in OMi.

For details, see the *OMi Administration Guide*.

9. Use OO functionality from OMi

You can trigger a run book:

- From Service Health by using the **Invoke Run Books** context menu option.
- From the Event Browser by using the context menu or from the Action Panel.

Chapter 29: Troubleshooting Integration Problems

Log Files

The `oo_integration.log` file enables you to perform basic troubleshooting of problems with OO integration and run book execution.

For automatic run book execution, the `oo_integration.log` file is available on the data processing server:

```
<OMi_HOME>/log/opr-backend/oo_integration.log
```

Log configuration can be performed in:

```
<OMi_HOME>/conf/core/Tools/log4j/opr-backend/OOIntegration.properties
```

For setting up and configuring the OO integration, as well as manual run book execution, the log file is available on the gateway server:

```
<OMi_HOME>/log/jboss/oo_integration.log
```

Log configuration can be performed here:

```
<OMi_HOME>/conf/core/Tools/log4j/jboss/OOIntegration.properties
```

Connection Errors

Connection errors when accessing Run Book Mappings page in OMi

If you receive a remote connection error in the Run Book Mappings page, and no actions are available for new or existing run books, check the `oo_integration.log` file on your gateway system. Look for the following text:

```
Failure: User was not authenticated.
```

If you find this text, do the following:

1. Check that the LWSSO integration is correctly configured between OMi and OO.
2. Make sure that the logged in user exists in OO and has the correct permissions.
3. Check that the configured integration user can authenticate against the OO system and has the correct permissions.

Connection errors when selecting run books in Available Run Books

If you receive a connection error when you select run books in the **Available Run Books** pane (**Library > Operations**), change the **run.book.timeout** and **service.center.ws.timeout** settings from 10000 to 60000 (1 minute):

1. Open a JMX console on the OMi server:

```
https://localhost:29000
```

2. Select **Foundations > service=Infrastructure Settings Manager**.
3. To set the values, use **setSettingValuePerCustomerId()** with **contextName: integrations** and **settingName: settings.pm.settings.run.book.timeout** or **settings.pm.settings.service.center.ws.timeout**. Change to **newValue: 60000**.

Note: Restarting OMi is not required.

Different Domains

If OMi and OO are in different domains, and you are using Internet Explorer as your browser, you may need to add the domains to the list of allowed domains in the Privacy tab (**Internet Options > Privacy > Sites**).

Web service API error

Problem: When logging into OMi with the integration user account, you receive the error "Web service API returned HTTP status 403: Forbidden".

Solution: This is a known issue with OO 10.20. To resolve the problem, log into OMi as the administrator and access **Administration > Setup and Maintenance > Infrastructure Settings**. In the **Foundations** context, select **Single Sign-On**. Set **Add user roles information to LW-SSO token** to **false**.

Chapter 30: Examples of Operations Manager i and Operations Orchestration Integrations

This section describes two possible scenarios to integrate OMi and OO.

Use Case Scenario in Service Health

In OO, the **Restart a Node** run book is associated with a Node CI Type. The parameters of the run book are mapped to the relevant CI attributes of the Node CI.

In Service Health, the operator detects that a host has a system problem. The operator right-clicks the CI to get a list of the run books relevant to the CI. One of the run books is **Restart a Node**. The run book can execute automatically because the values of the parameters such as the host name or the IP address are automatically populated by data taken from the CI context.

Use Case Scenario in the Event Browser

In the OMi Event Browser, the operator is going through the assigned events. The operator detects an event related to a lack of disk space that causes a database performance issue. From the event context, the operator can get a list of relevant run books. The operator can launch the appropriate run book manually. The run book continues running without further input from the operator as all run book parameters are extracted from the event or related CI.

Tip: If you set up the integration between OO and OMi, you can also use **Automatic Run Book Execution** to run an OO flow as an automatic action. For details, see the *OMi Administration Guide*.

Although OO flows are not set up as an automatic action in the policy, you can run OO flows automatically when the event comes into OMi, or as a result of time-based event automation.

Part VIII: Operations Manager i - Operations Bridge Analytics Integration

Chapter 31: Operations Manager i - Operations Bridge Analytics Integration Overview

Starting from the Operations Bridge Analytics (OBA) version 2.32, you can integrate OBA into your OMi environment.

The integration between OMi and OBA provides you with the following capabilities:

- **Cross Launch Integration.** You can configure an integration that enables you to open Operations Bridge Analytics directly from OMi in the context of a specific event or host. For more information, see ["Operations Bridge Analytics Cross Launch" on page 257](#).
- **OMi Dashboard Integration.** It is possible to configure a dashboard that displays the OBA user interface within OMi. This can be done by adding **opsa** as a new component to OMi. For more information, see ["OBA Dashboard Integration" on page 265](#).
- **OBA alerts > OMi events.** You can enable forwarding of OBA alerts to OMi, so that they are managed as OMi events. OBA alerts are triggered by the OBA operator for the selected topology elements in OBA. To be able to manage OBA alerts within OMi, you must first configure connections between OMi and OBA. For more information on how to do this, see ["Workflow: Configuring Connections Between OMi and OBA" on page 259](#).
- **OBA anomalies > OMi anomaly events.** Starting with OBA version 3.0, you can enable forwarding of OBA anomalies to OMi, so that they are managed as OMi anomaly events. OBA anomalies are triggered automatically by OBA when the greater deviation from the standard baseline is observed for a number of the monitored topology elements, such as metrics. Upon arrival of an anomaly event, you can set a rule that causes an alert to be created when the condition is met. This could be, for example, when the sufficient number of anomalies are detected or when the severity reaches the threshold. To be able to manage anomalies within OMi you must first configure connections between OMi and OBA. For more information on how this is done, see ["Workflow: Configuring Connections Between OMi and OBA" on page 259](#).
- **OMi policy based data collection.** You can configure policies in OMi to collect data and forward it to OBA. This enables central configuration of log collection and normalization of the incoming data. To do so, configure a structured log file policy to collect data and a data forwarding policy to forward the data to OMi. For information, see [Log Streaming](#).

Note: In order for LW-SSO authentication to work between OMi and OBA, you must use an integration user with the same name in OMi and OBA.

Chapter 32: Operations Bridge Analytics Cross Launch

You can configure an integration that allows you to open Operations Bridge Analytics from OMi in the context of a specific event or host. This allows you to open analysis tools from Operations Bridge Analytics, such as log analytics and predictive analytics, quickly and easily in the appropriate context.

How to set up a Cross Launch Integration for OMi Events

You can configure a cross launch for individual CI types from the OMi Operations Console. To do so, perform the following steps:

1. In OMi, login in as the integration user and navigate to:
Administration > Operations Console > Tools
2. In the **CI Types** pane, select the CI type for which you want to enable the cross launch.
3. In the Tools pane, select  **New**. Fill in the appropriate values on the **General** tab.
4. On the **Type** tab, select **URL**.
5. On the URL tab, specify a URL as seen in the following examples:

To query a single specified host over the last day:

```
http://<oba-server>:8080/opsa/#/logsearchpql?search=host%20withkey%20%22${event.node.dnsName}%22&selectedTimeRange=ONE_DAY
```

or

```
https://<oba-server>:8443/opsa/#/logsearchpql?search=host%20withkey%20%22${event.node.dnsName}%22&selectedTimeRange=ONE_DAY
```

To query all hosts over the last hour:

```
http://<oba-  
server>:8080/opsa/#/logsearchpql?search=host%20withkey%20%20*&selectedTimeRange  
=ONE_HOUR
```

or

```
https://<oba-  
server>:8443/opsa/#/logsearchpql?search=host%20withkey%20%20*&selectedTimeRange  
=ONE_HOUR
```

6. To test the URL, click **Test**.

How to Use a Cross Launch Integration from OMi

1. In OMi, navigate to:
Workspaces > Operations Console > Event Perspective
2. Right click the desired event, and selected **Launch > Tools** from the context menu.
3. Select the tool that you created for the OBA cross launch and click **Run**.

Chapter 33: Workflow: Configuring Connections Between OMi and OBA

To be able to manage OBA alerts and anomalies as OMi events, it is necessary to configure an OBA server as an OMi managed node. This means that you must have the Operations Agent installed on the OBA server, which then enables monitoring the OBA alerts and anomalies and forwarding them to OMi.

1. *OBA 2.3x only*. Install the Operations Agent on the OBA server

Note: You can skip this step if you have an OBA server version 3.0, because it comes with an Operations Agent version 12 preinstalled.

For task details, see "[OpsA 2.3x Only: Installing the Operations Agent on the OpsA Server](#)" on the next page.

2. Connect the Operations Agent to the OMi server

In addition to monitoring OBA alerts and anomalies, Operations Agent forwards them to OMi. Therefore, make sure to connect the Operations Agent to OMi.

For task details, see "[How to Connect the Operations Agent to OMi](#)" on page 261.

3. Import the content pack from OBA to OMi

OMi content packs are the part of the OBA installation. They contain the management templates and aspect area ready to be used by OMi.

Previously imported OBA content packs and old OBA management templates and aspects must be deleted.

For task details, see "[Importing Content Packs from the OBA Server](#)" on page 262.

4. Deploy and assign the management template from OMi to OBA

Import the `OMi_Content_Pack-OPSA.zip` from OBA to OMi. The imported management template must be deployed and assigned to the OBA server so that it can monitor the log files in which the OBA alerts and anomalies are written.

For task details, see "[How to Deploy and Assign Management Templates to an OBA Server](#)" on page 263.

Overview: Forwarding OBA Alerts and Anomalies to OMi

You can configure the Operations Agent to retrieve alerts and anomalies from OBA and forward them to OMi as events. This enables you to get the benefit from using both the capabilities of OBA to identify events by using analytic tools and the advanced event management capabilities available with OMi.

If configured so in OBA, the OBA alerts and anomalies are logged into one predefined log file located on the OBA server. When the Operations Agent is installed and configured on the OBA server as an OMi monitored node, it enables the Logfile Entry policy to monitor the log file and then forward the OBA alerts and anomalies to OMi to be managed as events and anomaly events. You can filter the log file entries by a set of rules in the policy.

Note: The OBA alerts and anomalies are sent with the Low, Medium and High severities, which are then mapped to the OMi severities (Critical, Major and Normal) in the policies.

For more information about policy management in OMi, see the *OMi Administration Guide*.

The following diagram shows the details of this integration:

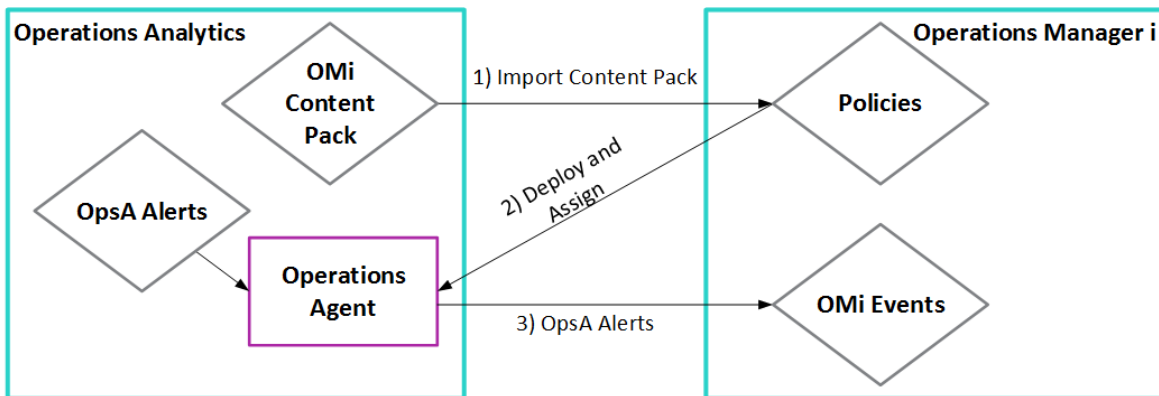

OpsA 2.3x Only: Installing the Operations Agent on the OpsA Server

To be able to manage OBA alerts and anomalies as OBA events in Operations Analytics 2.3x, you must configure the OpsA server as an OMi monitored node. This means that you must install the

Operations Agent on the OpsA server so that the policy templates can monitor the log files in which OpsA alerts and anomalies are written and create appropriate events in OMi.

Note: To be able to use OMi Monitoring Automation features, the Operations Agent 12 or later is required.

When installing the agent, specify the gateway server, the load balancer, or the reverse proxy as the agent's management server. For information about installing the Operations Agent, see the *Operations Agent and Operations Smart Plug-ins for Infrastructure Installation and Configuration Guide*.

When the communication between the agent and the OMi server is established and the agent processes are running, a node CI is created in the RTSM for the OpsA server. You can then deploy management templates, aspects, policies, and instrumentation to the node. Alternatively, if the node matches an automatic assignment rule, OMi creates an assignment for the CI, and starts the deployment jobs required to transfer the monitoring configuration to the node. After the agent starts monitoring the system, it sends events to OMi, which you can view in the Event Browser.

Note: The Operations Agent is available on the HPE Operations Agent media DVD, which is included in the OMi media kit. The latest agent updates can be downloaded from the [HPE Software Support](#) website.

How to Connect the Operations Agent to OMi

When you install and configure the Operations Agent on the OBA server, you connect it to OMi if you enter the management server. If this is not the case, for example, when the agent is installed in inactive mode, you must manually connect the agent to OMi, and then grant the required certificates to connect the OBA server as a monitored system to Monitoring Automation. To do so, follow these steps:

1. Connect the agent to OMi:
 - a. Log on to the OBA server.
 - b. Navigate to the following location:
 - `/opt/OV/bin/OpC/install/`
 - c. Run the following script to install the Operations Agent on the OBA server:
 - `oasetup -configure -management_server <Gateway_Server>`
2. In the OMi user interface, open the Certificate Requests manager and accept the new certificate request:

Administration > Setup and Maintenance > Certificate Requests

For more information about granting certificate requests, see the *OMi Administration Guide*.

Tip: You can grant certificates automatically by using preconfigured IP ranges or a groovy script. For details, see the *OMi Administration Guide*.

3. *Optional.* Check HTTPS communication in both directions:

```
bbcutil -ping https://<FQDN>
```

If the connection is successful, the command returns `status=eServiceOK`.

Importing Content Packs from the OBA Server

Operations Bridge Analytics provides content packs that contain the management templates and aspect area ready to be used by OMi. The following content packs are available for OMi. Import the content pack from the following location:

- For OBA 3.0 and OMi 9.2x use:

```
/opt/HP/opsa/content-packs /omi_content_pack/omi_092x_content_pack-3.00.zip
```

- For OBA 3.01 and OMi 10.0x use:

```
/opt/HP/opsa/content-packs /omi_content_pack/omi_100x_content_pack-3.01.zip
```

How to Import Content Packs

When you import a content pack, existing items with the same ID are generally overwritten. If you are importing a predefined content pack, only predefined content is overwritten with new data. Customized content is left untouched. Importing a custom content pack always overwrites existing data.

Unresolved references in the imported definition (for example, to unknown CI types) are not allowed. To import content packs, follow these steps:

Note: In SaaS installations, predefined content packs can only be imported by a SaaS Admin (Super User).

1. On OMi, import the content pack by using the Content Manager. Navigate to:

Administration > Setup and Maintenance > Content Packs

Select **Import Content Pack Definitions and Content**. Browse and locate the content pack you want to import.

Note: By default, OMi looks for content packs in the file system on the system where you start the browser session. If the browser is running on a remote system, you must navigate to the file system of the OMi host.

2. *Optional.* Click **Preview** to list the artifacts that are included in the selected content pack and any required and missing dependencies:
 - Contained artifacts (grouped by type)
 - Fulfilled dependencies to other Content Packs
 - Missing dependencies to other Content Packs

This does not run an import, no changes are committed to OMi.

The preview also shows whether the content pack to be imported is predefined or custom.

When it is predefined, there is a check mark next to the term *Predefined*. When it is custom, no check mark is displayed.

3. Select **Import** to start the import or test operation.

Note: If the import is running, you cannot start another one.

How to Deploy and Assign Management Templates to an OBA Server

You import a content pack from OBA to OMi, and then deploy and assign the imported management templates to the OBA server so that they can listen to the log files where the OBA alerts and anomalies are written. To do so, follow these steps:

1. In OMi, open Management Templates & Aspects:
 - Administration > Monitoring > Management Templates & Aspects**
2. In the **Configuration Folders** pane, select the **OpsA** folder.
3. In the **Management Templates & Aspects** pane, select **OpsA Aspect** and click **Assign and Deploy Item...** .

Note: The Assign and Deploy Item button is grayed out if the policy template contains a stub instrumentation. Upload the instrumentation by using the Content Manager.

4. In the **Assign and Deploy** wizard, select the configuration item (all OBA servers) to which you want to assign the management template. Specify parameters and configuration as needed, then click **Finish**.
5. *Optional.* In the Configure Options page, clear the **Enable Assignment(s)** check box if you do not want to enable the assignment immediately. You can enable the assignment later by using the Assignments & Tuning manager.
6. Click **Finish**. OMi creates deployment job, which deploys the management template to the node.

Note: After a policy template is deployed, the OMi server specified in the **Default Virtual Gateway Server for Data Collectors URL** infrastructure setting becomes the owner of the policy on the node.

7. To verify the deployment, select **OpsA alerts** in the Management Templates & Aspects pane and click  **List Assignments for Selected Item...**

Note: After a policy template is deployed, the OMi server specified in the **Default Virtual Gateway Server for Data Collectors URL** infrastructure setting becomes the owner of the policy on the node.

8. Verify the deployment. On the OBA server, run the following command:

```
/opt/OV/bin/ovpolicy -l
```

The result shows the deployed policies.

9. In OBA, create alerts and anomalies. For more information, see the OBA Online Help.

Chapter 34: OBA Dashboard Integration

In this chapter, you will configure an OMi dashboard that displays the OBA user interface.

Note: The OBA dashboard integration with OMi is not supported in Internet Explorer.

1. *Prerequisite.* LW-SSO must be configured in the OBA environment. For information on configuring LW-SSO in OBA, see the Operations Bridge Analytics Help.
2. In OBA, locate `<oba-server>/opt/HP/opsa/jboss/standalone/deployments/opsa-ui-web.war/WEB-INF/web.xml`.



As the root user, modify the following section from:

```
<init-param>  
<param-name>X-Frame-Options</param-name>  
<param-value>SAMEORIGIN</param-value>  
</init-param>
```

to

```
<init-param>  
<param-name>X-Frame-Options</param-name>  
<param-value>Allow-From http://<OMi URL>/opr-web</param value>
```

3. Restart the OBA server by running the command `opsa-server restart`.
4. HPE recommends adding a mapping of the OBA IP and the OBA FQDN in the window host file in every client machine that will be used to access OBA.
5. Delete the cookies of all browsers used to access OMi.
6. Add the FQDN of the OBA environment to the list of trusted hosts in OMi in the Authentication Management section. Navigate to **Administration > Users > Authentication Management**. In the Single Sign-On Configuration section, click **Edit** to open the Single Sign On Editor panel and add the OBA FQDN to the list of trusted hosts.
7. After you have completed the following workflow you will be able to open a log search based on an event in OMi focused on the last hour. In OMi, navigate to MyWorkspace and create a new page.
 - a. Log in to OMi as the integration user (a user set up with the same name in OMi and OBA).
 - b. Click **Add Component** to open the Component Gallery, and then click  **Add External Component** to create a new component.

- c. Specify a name for your component and the URL `<oba server FQDN>:<port>/`.
 - d. In the Configure Wiring section, click  Add Context and select **EventChange**.
 - e. In the URL Parameters and Value for EventChange section, click  **New Parameter**. Select Path and click OK. Click in the Value field next to (Path) and enter `opsa/#/logsearchpql`.
 - f. Click  **New Parameter** again and select Query String. Set the name to search and click OK. Click in the Value field next to search and enter the following:

```
host%20withkey%20(<< event.node.dnsName >>)&selectedTimeRange=ONE_
  HOUR&redirect
```

The attribute `event.node.dnsName` must be selected from the Attributes list.
 - g. Your finished URL pattern should be as follows: `http(s)://example.example.net:<port>/opsa/#/logsearchpql?search=host%20withkey%20(<< event.node.dnsName >>)&selectedTimeRange=ONE_HOUR&redirect`
 - h. Click OK to save the component.
 - i. You can change the above URL to perform an XQL search by changing the value you enter for Path as follows: `opsa/#/logsearchxql`. Set the value of Query String to `%20error%20hostname%3d<< event.node.dnsName >>&selectedTimeRance=ONE_HOUR&redirect`. The resulting URL has the following pattern: `http(s)://example.example.com:<port>/opsa/#/logsearchxql?search=Text:%20error%20hostname%3d<< event.node.dnsName >>&selectedTimeRance=ONE_HOUR&redirect`
8. Add the component to a page. The component must be the full width of the page. Do not add the OBA component on a page with another component. For best results, use screen resolution 1920x1200 and maximize the browser.

Part IX: OpsCx Integrations

OpsCx captures data such as events, metrics, and topology from third-party systems. Events and topology data are forwarded to OMi; metrics data is stored locally on the OpsCx system and can be viewed in OMi by using the Performance Dashboard. Service Health Reporter, a high-capacity performance reporting solution also enables you to generate reports on data collected by OpsCx.

To access

In OMi, select:

Administration > Setup and Maintenance > Connected Servers

For details on configuring an Operations Connector server in OMi, see the *Operations Connector User Guide*.

OpsCx Integrations Overview

From the Connected Servers page, you can access and maintain all OpsCxs in the OMi deployment environment, regardless of the operating system or host location on which the OpsCx is installed.

The Connected Servers page enables you to add, modify, or remove OpsCx integrations from the OMi deployment environment.

Before you can add an OpsCx integration, OpsCx must be installed in the OMi deployment environment. That is, the OpsCx host must have access to at least one OMi Gateway Server in the OMi deployment environment to which it sends the collected data. Additionally, OpsCx must have access to the third-party system from which it is collecting data.

For some types of data sources, OpsCx must be installed and run locally on the host of the third-party system with which it is integrating. Examples for local data sources are XML files, open message interface messages, and scheduled tasks. For other types of data sources, OpsCx can be installed on the host of the third-party system or on a remote system. For more information on supported data sources, see OpsCx Help.

The following diagram shows an example of an OMi deployment environment with four OpsCx integrations.

Operations Connector Example Deployment Scenario

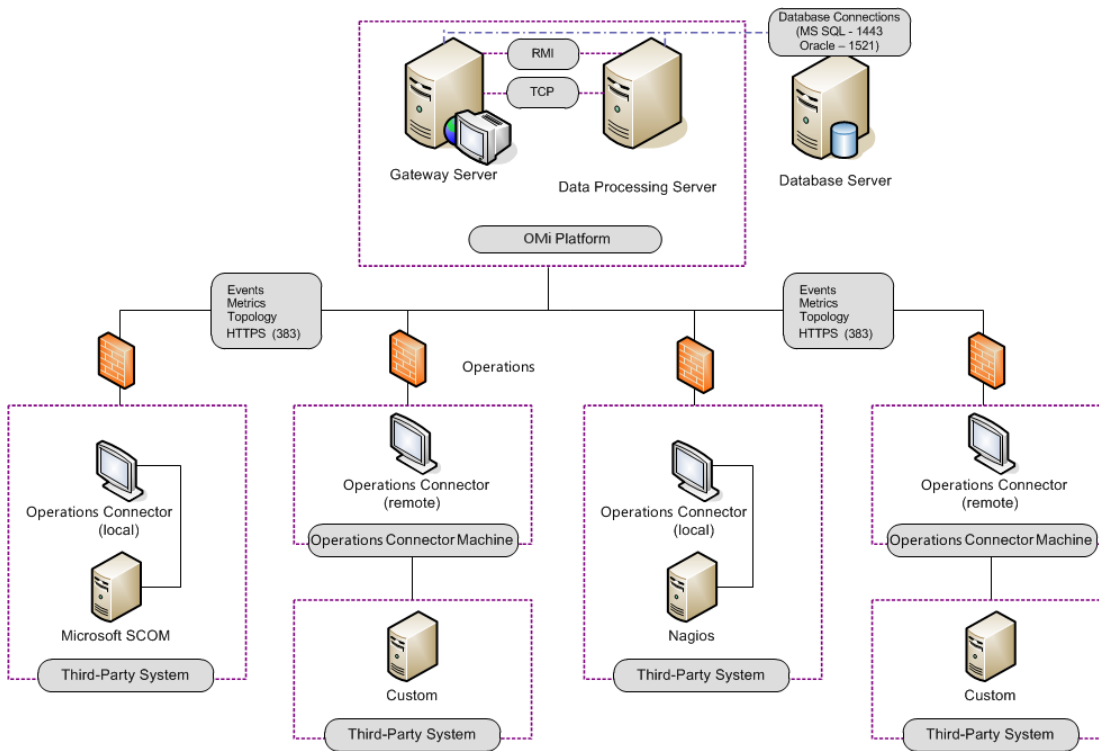

For information about installing OpsCx, see the *OpsCx Installation and Upgrade Guide*.

Controlling data transfer with policies

The data transfer is controlled by policies that you define in OpsCx. Policies monitor the data sources and, if certain conditions apply, forward the data in the form of events or metrics to OMi. The policies can optionally also map the data to topology and create configuration items (CIs) and CI relationships in OpsCx. This enables OMi to associate the events and metrics it receives with CIs.

Out-of-the box integrations

You can use one of the out-of-the box integrations that are available for Operations Connector. Alternatively, if you do not find the integration that you are looking for, you can develop your own custom integration.

HPE is continually updating the list of the integrations with third-party products. For details and for download information, see the HPE ITOM Marketplace:

<https://marketplace.saas.hpe.com/itom/category/all?product=Operations%20Bridge>

More information

For complete information about the features, capabilities, and usage of OpsCx, see OpsCx Help after you install OpsCx. To access the help, click **Help ?** in the toolbar of the OpsCx user interface.

Send documentation feedback

If you have comments about this document, you can [contact the documentation team](#) by email. If an email client is configured on this system, click the link above and an email window opens with the following information in the subject line:

Feedback on OMi Integrations Guide (Operations Manager i 10.61)

Just add your feedback to the email and click send.

If no email client is available, copy the information above to a new message in a web mail client, and send your feedback to ovdoc-asm@hpe.com.

We appreciate your feedback!



Go OMi!