



HP Operations Manager

Software Version: 9.22
UNIX and Linux operating systems

Reporting and Database Schema

Document Release Date: December 2016
Software Release Date: December 2016

Legal Notices

Warranty

The only warranties for HP products and services are set forth in the express warranty statements accompanying such products and services. Nothing herein should be construed as constituting an additional warranty. HP shall not be liable for technical or editorial errors or omissions contained herein.

The information contained herein is subject to change without notice.

Restricted Rights Legend

Confidential computer software. Valid license from HP required for possession, use or copying. Consistent with FAR 12.211 and 12.212, Commercial Computer Software, Computer Software Documentation, and Technical Data for Commercial Items are licensed to the U.S. Government under vendor's standard commercial license.

Copyright Notice

© Copyright 1993 - 2016 Hewlett-Packard Development Company, L.P.

Trademark Notices

Adobe® is a trademark of Adobe Systems Incorporated.

Microsoft® and Windows® are U.S. registered trademarks of Microsoft Corporation.

UNIX® is a registered trademark of The Open Group.

Documentation Updates

The title page of this document contains the following identifying information:

- Software Version number, which indicates the software version.
- Document Release Date, which changes each time the document is updated.
- Software Release Date, which indicates the release date of this version of the software.

To check for recent updates or to verify that you are using the most recent edition of a document, go to:

<https://softwaresupport.hpe.com>

This site requires that you register for an HP Passport and sign in. To register for an HP Passport ID, go to:

<https://cf.passport.hpe.com/hppcf/createuser.do>

Or click the **the Register** link on the HP Passport login page.

You will also receive updated or new editions if you subscribe to the appropriate product support service. Contact your HP sales representative for details.

Support

Visit the HP Software Support Online web site at: <https://softwaresupport.hpe.com>

This web site provides contact information and details about the products, services, and support that HP Software offers.

HP Software online support provides customer self-solve capabilities. It provides a fast and efficient way to access interactive technical support tools needed to manage your business. As a valued support customer, you can benefit by using the support web site to:

- Search for knowledge documents of interest
- Submit and track support cases and enhancement requests
- Download software patches
- Manage support contracts
- Look up HP support contacts
- Review information about available services
- Enter into discussions with other software customers
- Research and register for software training

Most of the support areas require that you register as an HP Passport user and sign in. Many also require a support contract. To register for an HP Passport ID, go to:

<https://cf.passport.hpe.com/hppcf/createuser.do>

To find more information about access levels, go to:

<https://softwaresupport.hpe.com/web/softwaresupport/access-levels>

HP Software Solutions Now accesses the HPSW Solution and Integration Portal Web site. This site enables you to explore HP Product Solutions to meet your business needs, includes a full list of Integrations between HP Products, as well as a listing of ITIL Processes. The URL for this Web site is <https://softwaresupport.hpe.com>

About this PDF Version of Online Help

This document is a PDF version of the online help. This PDF file is provided so you can easily print multiple topics from the help information or read the online help in PDF format. Because this content was originally created to be viewed as online help in a web browser, some topics may not be formatted properly. Some interactive topics may not be present in this PDF version. Those topics can be successfully printed from within the online help.

Contents

Chapter 1: HPOM Database Schema	11
In This Chapter	11
Introduction	11
General Conventions	12
Column Types in the Databases	12
Performing Queries	13
Adding Your Own HPOM Reports	14
Adding a Program Report	14
Adding an SQL Report	14
Adding Your Own HPOM Service Reports	20
HP Service Navigator Reports	20
Chapter 2: Entity Relationship Diagrams	22
In This Chapter	22
Entity Relationship Diagrams	22
Multiplicity 1	23
Multiplicity 2	23
Multiplicity 3	24
Chapter 3: User Tables	25
In This Chapter	25
opc_appl_groups Table	25
opc_appl_in_group Table	25
opc_appl_login Table	26
opc_appl_node_list Table	26
opc_appl_platforms Table	27
opc_applgrp_in_grp Table	27
opc_application Table	27
opc_capabilities Table	29
opc_integr_appl Table	30
opc_op_browser_set Table	31
opc_op_browser_set_cma Table	34

opc_op_browser_set_obj Table	35
opc_op_defaults Table	36
opc_op_desk Table	40
opc_op_group_desk Table	40
opc_op_profiles Table	41
opc_op_realm Table	41
opc_op_services Table	41
opc_user_data Table	42
Chapter 4: Node Tables	44
In This Chapter	44
opc_category Table	44
opc_chsets Table	44
opc_comm_type Table	45
opc_mgmtsv_config Table	46
opc_net_machine Table	48
opc_net_sec_types Table	60
opc_node_alt_addr Table	60
opc_node_alt_name Table	61
opc_node_alt_v6_addr Table	61
opc_node_cat Table	61
opc_node_cat_config Table	62
opc_node_defaults Table	62
opc_nodegrp_cat Table	68
opc_node_groups Table	68
opc_node_names Table	69
opc_node_pattern Table	70
opc_nodehier_layout Table	71
opc_nodehiers Table	72
opc_nodes Table	72
opc_nodes_in_group Table	83
opc_platform_dictionary Table	83
opc_pltfrm_family Table	84
opc_policy_cat Table	84

opc_tmplgrp_cat Table	85
Chapter 5: Policy Tables	86
In This Chapter	86
opc_node_config Table	86
opc_source_tmpl Table	87
opc_tmpl_groups Table	89
opc_tmpl_in_tgrp Table	89
opc_tmpl_on_ngrp Table	90
opc_tmpl_options Table	91
opc_tmpl_status Table	92
opc_tmpl_on_node Table	93
opc_tgrp_in_tgrp Table	94
opc_tgrp_on_ngrp Table	95
opc_tgrp_on_node Table	96
Chapter 6: Condition Tables	97
In This Chapter	97
opc_appresp_id_lst Table	97
opc_cond Table	97
opc_cond_appl_list Table	98
opc_cond_cust_attrib Table	99
opc_cond_mgrp_list Table	99
opc_cond_node_list Table	99
opc_cond_obj_list Table	100
opc_cond_oper_list Table	100
opc_cond_sev_list Table	101
opc_cond_stat_var Table	101
opc_cond_text Table	101
opc_cond_type_list Table	102
opc_mpi_reg_conds Table	102
opc_msg_key_rel Table	103
opc_open_mpis Table	104
opc_rgr_cond Table	104
opc_snmp_variables Table	105

Chapter 7: Message Tables	106
In This Chapter	106
opc_act_cust_attrib Table	106
opc_act_messages Table	107
opc_anno_text Table	114
opc_annotation Table	114
opc_escal_assign_m Table	115
opc_forward_msgs Table	116
opc_hist_anno_text Table	117
opc_hist_annotation Table	117
opc_hist_cust_attrib Table	118
opc_hist_messages Table	118
opc_hist_msg_text Table	125
opc_hist_orig_text Table	126
opc_instr_interf Table	126
opc_instructions Table	127
opc_msg_text Table	127
opc_orig_msg_text Table	128
opc_service_msgs Table	128
Chapter 8: Other Tables	129
In This Chapter	129
opc_change_status Table	129
opc_cma_names Table	130
opc_db_maintenance Table	130
opc_message_groups Table	131
opc_notif_schedule Table	132
opc_notif_services Table	133
opc_service Table	133
opc_service_log Table	133
opc_symbols Table	135
opc_temp_appl_list Table	136
opc_temp_msggrp_list Table	136
opc_temp_node_list Table	136

opc_temp_object_list Table	136
opc_temp_service_list Table	137
opc_temp_tmpl Table	137
opc_tmp_filter_appl Table	137
opc_tmp_filter_cma Table	137
opc_tmp_filter_msggrp Table	138
opc_tmp_filter_node Table	138
opc_tmp_filter_obj Table	138
opc_tmp_filter_pattern_node Table	138
opc_tmp_filter_service Table	139
opc_tmp_misc_msggrp Table	139
opc_tmp_msg_id Table	139
opc_tmp_msg_id_service Table	139
opc_tmp_valid_msggrp Table	140
opc_tmp_visible_msggrp Table	140
opc_tmp_visible_node Table	140
opc_tmp_visible_node2 Table	140
opc_tmp_visible_pattern Table	141
opc_tmp_visible_profile Table	141
opc_tmp_visible_service Table	141
opc_trouble_ticket Table	142
opc_s2s_sync Table	142
opc_policy_type Table	142
opc_policy_body Table	143
opc_policy_attr Table	144
opc_op_filter Table	144
opc_license_info Table	145
opc_license_count Table	145
opc_instr_in_policy Table	145
opc_filter Table	146
Chapter 9: Database Views	147
In This Chapter	147
opc_v_ack_messages View	147

opc_v_ack_messages_by_date View	147
opc_v_actions View	148
opc_v_all_messages View	148
opc_v_all_user_profiles View	148
opc_all_user_realm View	149
opc_v_assigned_mess View	150
opc_v_mess_serv View	150
opc_v_nodegrp_msg View	151
opc_v_node_count View	151
opc_v_node_severities View	152
opc_v_operator_msg_load View	152
opc_v_service View	153
opc_v_service_log View	153
opc_v_service_msg View	154
opc_v_service_msgs_act View	154
opc_v_unassigned_messages View	155
opc_v_unassigned_resp View	155
Chapter 10: Secondary Indexes	156
In This Chapter	156
Secondary Indexes	156
Chapter 11: Foreign Keys	159
In This Chapter	159
Foreign Keys	159
Appendix A: Database Changes	162
Database Changes with HPOM 9.xx	162
UTF-8 Encoding	162
Fields	162
Obsolete Tables	162
New Tables	162
New Fields in the Existing Tables	163
Fields with Additional Values	165
Diagram of User Tables	166

Diagram of Node Tables	167
Diagram of Policy Tables	168
Diagram of Message Tables	169
Send Documentation Feedback	170

Chapter 1: HPOM Database Schema

In This Chapter

This chapter introduces the HPOM database schema. It explains the areas that this book covers and describes how to use the information provided to write and display your own reports in HPOM.

Introduction

This chapter provides information about the definitions and contents of the HPOM database tables. You can generate reports or perform queries by using any report tools compatible with the database.

Note: All of the tables defined in this manual are considered read-only. You can query the tables at any time for report generation, but you must not write to the tables. Writing to the tables directly is not supported by Hewlett-Packard.

Also, tables and fields may change in future releases of HPOM. Hewlett-Packard does not guarantee that the reports you develop will work with future releases of HPOM.

[Table 1](#) gives an overview of the organization of the information in this manual.

Table 1: HPOM Database

Chapter	Data
Message Tables	All data regarding HPOM messages.
User Tables	All data regarding HPOM users.
Node Tables	All data regarding HPOM managed nodes.
Policy Tables	All data regarding message source policies.
Condition Tables	All data regarding conditions of message source policies.
Other Tables	For example, data regarding HPOM message groups and temporary data.
Secondary Indexes	Secondary indexes.
Foreign Keys	Foreign keys.

General Conventions

Most indexing key fields are implemented as 36-byte character Universal Unique Identifiers (UUIDs) to make key generation easier and be consistent with the object identifiers used by other HP Software databases.

HPOM uses a special null ID that consists of 36 zeros, except for foreign keys which use database null values.

Enumerated types are implemented as integer fields. The possible values are given in the Description column. The values for Yes/No are 1/0.

The Constraint column describes the constraints of each table column. See [Table 2](#) for the used constraints.

Table 2: Notation of the Constraint Field

Short Form	Constraint	Description
P	Primary Key	Values in primary key columns may never be null. The primary key identifies a row and therefore must be unique. If several columns in a table belong to the primary key, the combination of the primary keys has to be unique.
F	Foreign Key	A foreign key column references the primary key of another table.
N	Not Null	Not null columns must contain a value. Note that the database interprets an empty string as NULL. String columns that cannot contain empty strings are NOT NULL.
U	Unique Constraint	The unique column or the combination of unique columns must be unique. Note, however, that all or some columns of the unique constraint may be NULL. NULL is considered for uniqueness.

Column Types in the Databases

Most of the column types used for the Oracle and PostgreSQL databases are the same. However, there are several column types that differ. These column types are listed in [Table 3](#). Make sure that you are familiar with them before you start working with the reports in HPOM.

Table 3: Different Column Types in the Databases

Column Name	Oracle Database Column Type	PostgreSQL Database Column Type
(various column names)	varchar2	varchar
(various column names)	number	numeric
(various column names)	date	timestamp
policy_body	blob	bytea
policy_template	blob	bytea
filter_data	clob	text

Important: Be aware of the differences in the column types. The tables in this document mention the “varchar2” and “number” Oracle database column types. If you work with the PostgreSQL database, keep in mind that “varchar” and “numeric” column types are used instead.

Performing Queries

HPOM supports the following query methods:

- **HPOM user interface**

HPOM reports that are called from the HPOM user interface. HPOM provides the following report types:

- Report programs

You can add your own programs as described in ["Adding a Program Report" on the next page](#).

- SQL reports

You can add your own SQL reports as described in ["Adding an SQL Report" on the next page](#).

- HPOM internal reports

These reports use internal C functions and, consequently, may not be added or modified.

- **Reporting tools accessing the database directly**

Reports generated by any reporting tool that can access the database.

- **Service Reports**

HPOM-specific service reports are included in the HP Reporter product and can be viewed over the web. For more information on how to add new service reports and how to modify existing ones, see the HP Reporter documentation.

Adding Your Own HPOM Reports

This section gives you an idea of how to add your own reports to the list of reports already available to HPOM users. It covers the following general areas:

- ["Adding a Program Report" below](#)
- ["Adding an SQL Report" below](#)

Adding a Program Report

If you have a program that you want to make accessible to the HPOM users as a report from the Java GUI or the Administration UI, carry out the following steps:

1. Decide whether the report should be accessible by the administrator, by the operators, or both. Administrator reports are registered in the following file:

```
/etc/opt/OV/share/conf/OpC/mgmt_sv/reports/<LANG>/admin.rpts
```

Operator reports are registered in the following file:

```
/etc/opt/OV/share/conf/OpC/mgmt_sv/reports/<LANG>/oper.rpts
```

2. Open the appropriate file and add or modify the lines listed in the example below. The example below creates an OS user report that displays the `/etc/passwd` file:

```
REPORTNAME      OS user report
REPORTTYPE      PGM
DESCRIPTION     Show all OS users configured on this system (in /etc/passwd)
REPORTFILE      /bin/cat
PARM            /etc/passwd
```

Adding an SQL Report

This section describes the steps for defining a report that allows HPOM users to query data from the HPOM database. To run an SQL script, the Oracle database uses SQL*Plus, while the PostgreSQL

database uses `psql`.

Note: SQL reports are stored in the following directory:

```
/etc/opt/OV/share/conf/OpC/mgmt_sv/reports
```

When the `call_sqlplus` script is called, it searches for the specified report in the following order:

1. In the subdirectory corresponding to the current LANG value
2. In the C subdirectory
3. In any other subdirectory

The following example explains how to create an administrator report that shows which users are responsible for a selected message group and what the corresponding node groups are. Follow these steps:

1. Decide which data you need for the report. The HPOM database tables and their relationships are described in the remainder of this manual.

For this example, the `opc_op_realm` table contains the details of the responsibilities of the HPOM users and the message group name that is specified as a parameter. The `opc_user_data` table lists the HPOM users.

The link between `opc_op_realm` and `opc_user_data` is `user_id`, namely `opc_op_realm.user_id -> opc_user_data.user_id`. The `opc_node_groups` table lists the node group names and is linked to `opc_op_realm` by `node_group_id`, namely `opc_op_realm.node_group_id -> opc_node_groups.node_group_id`.

2. Create the SQL statement that extracts the information you need. As a test, set a fixed value for the message group name. For example:

```
select distinct u.name, g.node_group_name
from   opc_user_data u, opc_op_realm r, opc_node_groups g
where  r.user_id      = u.user_id
and    r.node_group_id = g.node_group_id
and    r.msg_group_name = 'OS'
order  by 1,2;
```

To test the SQL statement, you can use SQL*Plus (the Oracle database) or `psql` (the PostgreSQL database). Depending on the database you are using, run the following command:

- Oracle:

```
$ORACLE_HOME/bin/sqlplus opc_report@ov_net
```

After you run this command, you are asked for the `opc_report` password. To exit SQL*Plus, type `quit`.

- PostgreSQL:

```
$(psql_bin_directory)/psql -U opc_op -d openview -h \ <hostname> -p <port>
```

For example:

```
$/opt/pgsql-9.0/bin/psql -U opc_op -d openview -h \ localhost -p 5432
```

To exit `psql`, type `\q`.

3. Format your report to look like an HPOM report:

- Oracle database:

Select the text from the Oracle dummy table, `dual` to format your report.

SQL*Plus allows you to pass parameters. In the SQL*Plus script, the first parameter is referred to as `&1`. Because the parameter in the example is a string, it has to be enclosed in single quotes: `'&1'`

The name of the report in this example is `msggrp_users.sql`. It resides in the directories specified in ["Adding a Program Report" on page 14](#). You can copy an existing report and modify the header as appropriate. The report in this example, `msggrp_users.sql`, is as follows:

```
REM various SQL*Plus settings, e.g. to suppress terminal output
set heading off
set termout off
set echo off
set linesize 79
set pagesize 0
set feedback off
set newpage 0;
set Verify Off
set arraysize 5
title off;
```

```
REM Print a report header like the other HPOM reports
select ' ' from dual;
select '                               HPOM Report' from dual;
```



```
select '          -----' from dual;
select ' ' from dual;
select 'Report Date: ',sysdate from dual;
select ' ' from dual;
select 'Report Definition:' from dual;
select ' ' from dual;
select ' User:          opc_adm' from dual;
select ' Report Name:   Message group users' from dual;
select ' Report Script: msggrp_users.sql' from dual;
select ' ' from dual;
select ' ' from dual;

REM Add a header for the selected columns
select 'User name          Node group name' from dual;
select '-----' from dual;

REM Our SQL statement; the message group name is passed as
REM parameter &1
select distinct u.name, g.node_group_name
from   opc_user_data u, opc_op_realm r, opc_node_groups g
where  r.user_id      = u.user_id
and    r.node_group_id = g.node_group_id
and    r.msg_group_name = '&1'
order  by 1,2;

REM Finally, exit SQL*Plus
quit
```

- PostgreSQL database:

There are less formatting options with the PostgreSQL database than with the Oracle database. Use the `\pset` subcommands and the `select '<text>';` lines to format the report. However, you do not have to add the `from dual;` part because the syntax of the PostgreSQL database varies in this case.

The extension for PostgreSQL reports is `.psql`, so make sure to save your files accordingly.

To pass the parameters, use `-v <varname>=<value>`. The `call_sqlplus.sh` script automatically sends all parameters to `psql` as `v1=<value1>`, `v2=<value2>`, and so on. If the parameters are numeric values, you can use them as `:v1` in the script. If the parameters are strings or require single quotes in the script, you must add the following line at the beginning:

```
\set qv1 '\'' :v1 '\''
```

After you add this line, you can use the parameter as :qv1 in the script. Make sure that you do the same for all other parameters that require this line.

The name of the report in this example is sel_msg.psql. You can find it in the directories specified in ["Adding a Program Report" on page 14](#). You can copy an existing report and modify the header as appropriate. The report in this example, sel_msg.psql, is as follows:

```
\encoding 'UTF8'
\t on
\pset format wrapped
\pset columns 0

\set qv1 '\ ' :v1 '\ '

\t on

select ' ' ;
select '                                HPOM Report' ;
select '                                -----' ;
select ' ' ;
select 'Report Date:
',substr(TO_CHAR(CURRENT_TIMESTAMP,'DD-MON-YYYY'),1,20) ;
select ' ' ;
select 'Report Time:
',substr(TO_CHAR(CURRENT_TIMESTAMP,'HH24:MI:SS'),1,20) ;
select ' ' ;
select 'Report Definition:' ;
select '' ;
select ' User:          opc_adm' ;
select ' Report Name:  Selected Message ' ;
select ' Report Script:
/etc/opt/OV/share/conf/OpC/mgmt_sv/reports/C/sel_msg.sql' ;
select ' ' ;

\t off

\pset title 'Custom Message Attributes'

select
    cma.cma_name as "CMA Name",
    cma.cma_value as "CMA Value"
from
    opc_act_cust_attrib cma
where
    cma.message_number = :qv1
order by cma_name;
\t on
```

```
\pset title 'Original Text' ;
select omt.text_part as orig_text
  from
    opc_orig_msg_text omt
  where
    omt.message_number =:qv1
  order by order_number;

select omt.text_part as orig_text
  from
    opc_hist_orig_text omt
  where
    omt.message_number =:qv1
  order by order_number;

\pset title 'Service Name'
select
  sn.service_name
  from
    opc_act_messages sn
  where
    sn.message_number = :qv1
union
select
  sn.service_name
  from
    opc_hist_messages sn
  where
    sn.message_number = :qv1;
\q
```

4. Test the report by using the HPOM report script, `call_sqlplus.sh`. It connects as user `opc_op` to the HPOM database and runs the report script using `SQL*Plus` or `psql`, depending on the database that you are using. Note that the `.sql` (the Oracle database) or `.psql` (the PostgreSQL database) file is not specified. Type the following command:

```
/opt/OV/bin/OpC/call_sqlplus.sh msggrp_users OS
```

For more information, see the `call_sqlplus.sh(1)` manual page.

5. Decide whether the report should be accessible by the administrator, by the operators, or by both. See ["Adding a Program Report" on page 14](#) for information on your subsequent steps. Since the report in this example is available only to the administrator, add the following lines to the file, `admin.rpts`:

```
REPORTNAME Message group users
REPORTTYPE  PGM
```

```
DESCRIPTION  Users responsible for a selected message group
REPORTFILE   /opt/OV/bin/OpC/call_sqlplus.sh msggrp_users
PARM         $msggrp
```

Adding Your Own HPOM Service Reports

HPOM-specific service reports use information taken directly from the HPOM database and may be viewed using HP Reporter. You can add new service reports and modify the existing reports to suit the demands of your own environment. For requirements and instructions for editing HPOM-specific service reports, see the HP Reporter product documentation.

HP Service Navigator Reports

HP Reporter also comes with several reports for Service Navigator. They display information about the monitored services in different presentation forms, such as graphs or tables. These reports are, for example, the general availability of services over time, the number of messages received for each service over time, or the services with the highest number of messages.

To write your own reports, query the tables `opc_service` and `opc_service_log`. For more information, see [Table 98](#) and [Table 99](#). `opc_service` contains basic information about each service, for example, the label of a service. `opc_service_log` contains the status logs that include severity and the duration of the severity status. Both tables are empty, if logging is disabled.

When you query `opc_service_log` to generate a report about the status of a service within a time interval, (for example, how often and how long a service was in a warning status during a particular month) take into account the fact that the start and the end time of the severity status can be outside of the queried time interval.

[Figure 1](#) shows how the time when a service entered or left a certain severity status can affect service reporting.

Figure 1: Reporting on Service Status Duration

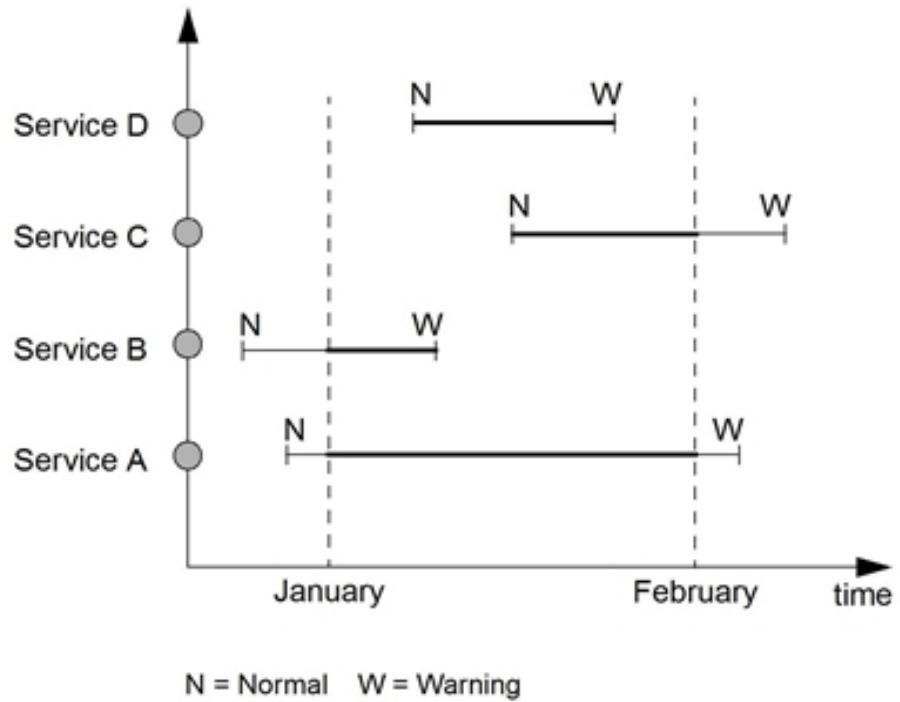

Consider the following scenarios:

- **Start time is outside the interval**

See Service A and Service B in Figure 1: severity statuses of both services change from normal to warning before the start of the queried time interval.

- **End time is outside the interval**

See Service A and Service C in Figure 1: severity statuses of both services cease to be in the warning state outside the queried time interval.

- **Start and end time are outside the interval**

See Service A in Figure 1: severity status of Service A changes from normal to warning before, and changes back to the normal state after the queried time interval.

When generating a report, make sure that it considers the actual start and end time of the severity duration in case they happen to be outside the queried time interval.

Chapter 2: Entity Relationship Diagrams

In This Chapter

This chapter describes the entity relationship diagrams for the HPOM database.

Note: The entity relationship diagrams that you can find at the end of this manual are graphical presentations of some of the tables related to users, nodes, policies, and messages.

Entity Relationship Diagrams

The entity relationship diagrams show some of the tables related to users, nodes, policies, and messages. They do not represent the entire HPOM database.

Many tables contain references to the `opc_symbols` table through the `symbol_type_id` column. Because of space limitations, however, the `opc_symbols` table does not always appear in the diagrams.

Links normally reside in the equally named columns in both tables, and are not labelled. However, in cases when links are present in more than one column, it is indicated.

[Figure 2](#) shows the notation used in the diagrams.

Figure 2: Diagram Notation

Multiplicity of Relationships

- || Exactly One
- < Many (more than one)
- | Optional (0 or 1)
- |< One or More
- < Zero, One, or More

Relationships that cannot be described using the notation are described in plain text.

Multiplicity 1

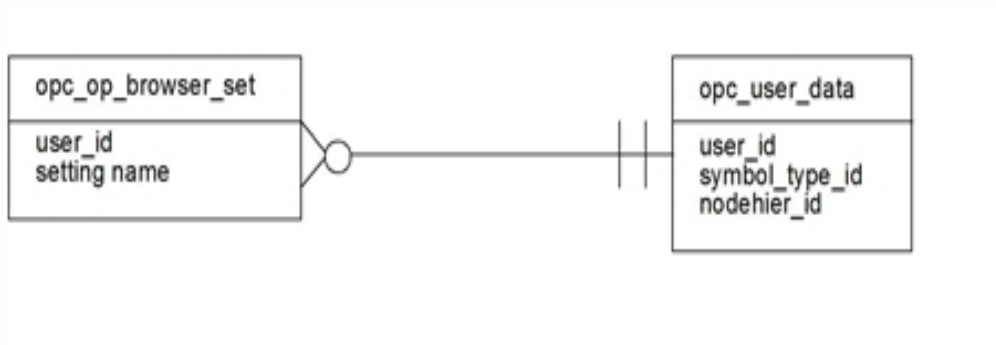

"Multiplicity 1" above shows that a user in the `opc_user_data` table has zero, one, or more saved browser settings in `opc_op_browser_set`. In other words, a user may save one or more browser settings, but does not have to.

Each browser setting belongs to exactly one user. Since no name appears on the relationship line, the relationship is based on the common key, `user_id`.

Multiplicity 2

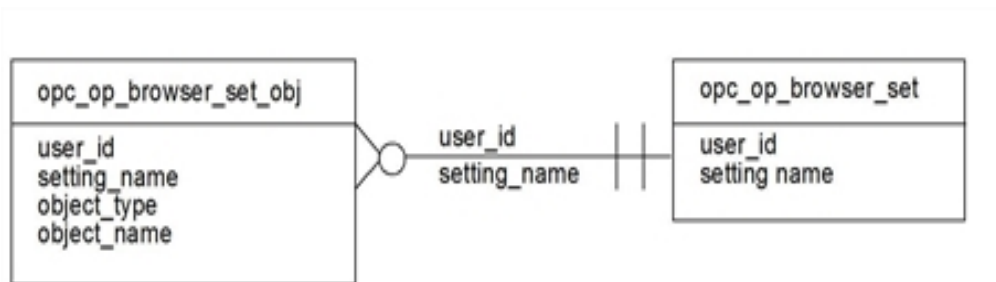

"Multiplicity 2" above shows that a browser setting may have zero, one, or more selected objects, for example, selected nodes. Each of the selected objects in `opc_op_browser_set_obj` belongs to exactly one browser setting. To show that the tables are related by a combination of `user_id` and `setting_name`, both these column names appear next to the relationship line.

Multiplicity 3

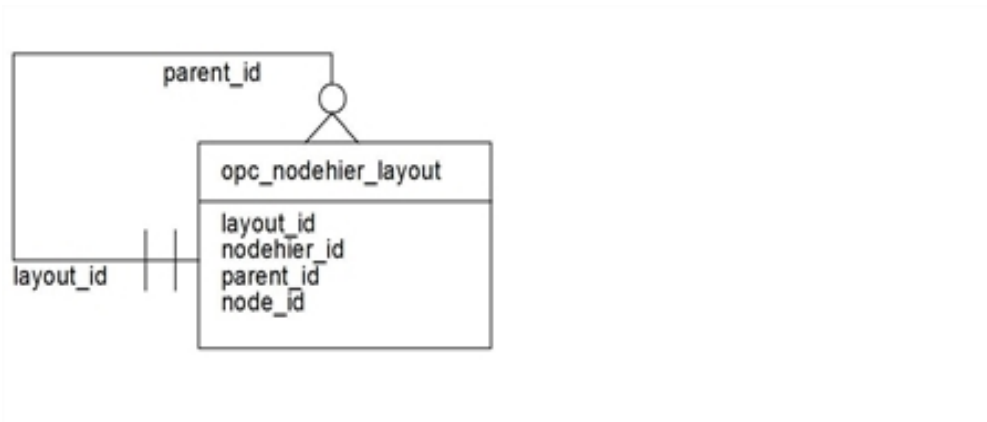

"Multiplicity 3" above shows that the `opc_nodehier_layout` table represents a hierarchy of nodes through a relationship with itself. If a hierarchy element (represented by `layout_id`) has no parent hierarchy, `parent_id` is null. Otherwise, the `parent_id` points to the `layout_id` of the layout element that contains this one.

A layout element may contain zero, one, or more other layout elements.

Chapter 3: User Tables

In This Chapter

This chapter contains the user tables.

opc_appl_groups Table

This table represents application groups.

Table 4: opc_appl_groups Table

Column Name	Constraint	Column Type	Description
appl_group_id	N, P	varchar2(36)	Key field to identify the application group.
symbol_type_id	N	varchar2(36)	Key field to identify the symbol type strings.
name	N, U	varchar2(508)	Name of the application group. The name must be unique.
label		varchar2(508)	Displayed label of the application group.
description		varchar2(508)	Description of the application group.
info		varchar2(4000)	Field for the operator's notes, for example, for tracking the changes.

opc_appl_in_group Table

This table represents the relationships of applications to application groups. Each application in each application group has an entry in this table.

Table 5: opc_appl_in_group Table

Column Name	Constraint	Column Type	Description
appl_group_id	U	varchar2(36)	Key field to identify the application group.
application_id	N, U	varchar2(36)	Key field to identify the application.

opc_appl_login Table

This table stores the name and password combinations for HPOM internal applications for different platform families.

Table 6: opc_appl_login Table

Column Name	Constraint	Column Type	Description
pltfm_family_name	N, P	varchar2(64)	Unique name for platform family.
application_id	N, P	varchar2(36)	ID of internal application.
user_name		varchar2(508)	Actual user name.
password		varchar2(144)	Actual password.

opc_appl_node_list Table

This table contains details of the target nodes where the applications are executed. The administrator configures these details in HPOM.

Table 7: opc_appl_node_list Table

Column Name	Constraint	Column Type	Description
application_id	N, U	varchar2(36)	Key field to identify the application.
entry_type	N, U	number(3)	Type of entry: node_id or string.
node_string	U	varchar2(2048)	<p>This field contains a string that represents an object or a node_id (depending on the entry_type field).</p> <p>Possible values:</p> <p>0...Variable (the node string contains text with pattern matching)</p> <p>1...IP node (the node string contains the node's ID in opc_node_names)</p> <p>2...non IP node (the node string contains the node's ID in opc_node_names)</p>

opc_appl_platforms Table

Note: [Table 8](#) is reserved for future use.

This table contains, for each application, a list of machine types where the application is available. The combination of `application_id` and `machine_type` must be unique.

Valid keys for machine types depend on the information provided in "[opc_net_machine Table](#)" on [page 49](#), and are linked to the entries found in this table.

Table 8: opc_appl_platforms Table

Column Name	Constraint	Column Type	Description
<code>application_id</code>	U, N, F	<code>varchar2(36)</code>	Key field to identify the application; linked to <code>application_id</code> in " opc_application Table " on the next page .
<code>machine_type</code>	U, N	<code>number(5)</code>	Key field to identify the machine type; linked to <code>machine_type</code> in " opc_net_machine Table " on page 49 .

opc_applgrp_in_grp Table

This table contains the assignments of application groups to application groups.

Table 9: opc_applgrp_in_grp Table

Column Name	Constraint	Column Type	Description
<code>appl_group_id</code>	F, U	<code>varchar2(36)</code>	Key field to identify the application group.
<code>member_appl_grp_id</code>	N, F, U	<code>varchar2(36)</code>	Key field to identify the assigned application group.

opc_application Table

This table contains attributes that are common to all applications. Attributes that are used only for particular applications are listed as follows, with regard to the application type:

- HPOM internal applications have one entry per platform family in `opc_appl_login` (see "[opc_appl_login Table](#)" on page 26).
- HPOM integrated applications have one entry in `opc_integr_appl` (see "[opc_integr_appl Table](#)" on page 30).

[Table 5](#) describes which application belongs to which application group.

Table 10: `opc_application` Table

Column Name	Constraint	Column Type	Description
<code>application_id</code>	N, P	<code>varchar2(36)</code>	Key field to identify the application.
<code>symbol_type_id</code>	N	<code>varchar2(36)</code>	Key field to identify the symbol type strings.
<code>application_type</code>	N	<code>number(3)</code>	Type of application: HPOM-integrated or internal. Possible values: 0...HPOM internal application 1...Integrated application
<code>target</code>	N	<code>number(3)</code>	The target where the application is started. Possible values: 0...Start on management server 1...Start on target nodes selected by operator 2...Start on the listed target nodes 3...Start on local GUI client 4...Start URL on local web browser

opc_application Table, continued

Column Name	Constraint	Column Type	Description
intern_appl_action	N	number(3)	Action for the internal application. Possible values: 0...Virtual Terminal 2...Broadcast The following values are obsolete: 1...Physical Terminal 3...Virtual Terminal on a PC
name	N, U	varchar2(508)	Name of the application. The name must be unique.
label		varchar2(508)	Displayed label of the application symbol.
description		varchar2(508)	Description of the purpose of this application.
appl_call		varchar2(4000)	The command that calls the application.
allow_customize	N	number(3)	Reserved for future use. Indicates whether command customization is allowed for the application: Yes/No. Both this field and the customize_appl field in the opc_capabilities table must be set before command customization is allowed.
appl_license_flag		number(3)	If set to 1, apply execution confirmation dialog. If set to 0 (default), do not ask before execution.
appl_license_text		varchar2(4000)	Application confirmation text to be shown.
info		varchar2(4000)	Field for operator's notes, for example, for tracking the changes.

opc_capabilities Table

This table contains information about user's permissions in HPOM.

Table 11: opc_capabilities Table

Column Name	Constraint	Column Type	Description
user_id	N, P	varchar2(36)	Key field to identify the user.
op_init_act_flag	N	number(3)	Indicates whether the user can start operator-initiated actions: Yes/No.
acknowledge_flag	N	number(3)	Indicates whether the user can acknowledge or unacknowledge messages: Yes/No.
change_msg_attr	N	number(3)	Indicates whether the user can change message attributes: Yes/No.
own_flag	N	number(3)	Indicates whether the user can own messages: Yes/No.
customize_appl	N	number(3)	Reserved for future use. Indicates whether command customization capability is allowed: Yes/No. Both this field and the allow_customize field in the opc_application table must be set before command customization is allowed.

opc_integr_appl Table

This table contains details of HPOM-integrated applications.

Table 12: opc_integr_appl Table

Column Name	Constraint	Column Type	Description
application_id	N, P	varchar2(36)	Key field to identify the application.
start_in_term_flag	N	number(3)	Start application in terminal window. Possible values are: 0...No window 1...Window (input and output) 2...Window (output only)

opc_integr_appl Table, continued

Column Name	Constraint	Column Type	Description
parameters		varchar2(508)	Parameters for the program call.
user_name		varchar2(508)	The user name under which the program is started.
password		varchar2(104)	The appropriate password for the user_name.

opc_op_browser_set Table

This table contains the main entry of an operator's saved browser settings. These are the filters that specify which messages appear in the in the View, History, and the Pending Messages browsers.

Table 13: opc_op_browser_set Table

Column Name	Constraint	Column Type	Description
user_id	N, P	varchar2(36)	Key field to identify the user.
setting_name	N, P	varchar2(64)	Key field to identify the browser setting.
selected_flag	N	number(3)	Display selected messages: Yes/No.
severity	N	number(3)	Display messages filtered by severity levels: Possible values: 1...Unknown 2...Normal 4...Warning 16...Minor 32...Major 8...Critical To filter for more than one severity, use a logical OR.
time_mode	N	number(12)	Time mode: Absolute/Relative time.

opc_op_browser_set Table, continued

Column Name	Constraint	Column Type	Description
time_from	N	number(12)	Start date/time of message reception on the management server.
time_to	N	number(12)	Finish date/time of message reception on the management server.
creat_time_from	N	number(12)	Reserved for future use. Start date/time of message creation on the managed node.
creat_time_to	N	number(12)	Reserved for future use. Finish date/time of message creation on the managed node.
ackn_time_from	N	number(12)	Reserved for future use. Start date/time of message acknowledgement.
ackn_time_to	N	number(12)	Reserved for future use. Finish date/time of message acknowledgement.
pattern		varchar2(508)	Text pattern to be used as a message filter.
unmatched_flag	N	number(3)	Display only unmatched messages: Yes/No.
logonly_flag	N	number(3)	Filter out all except log only messages: Yes/No.
notification_flag	N	number(3)	Reserved for future use. Filter out all except notification messages: Yes/No.
trouble_tick_flag	N	number(3)	Reserved for future use. Filter out all except trouble ticket messages: Yes/No.

opc_op_browser_set Table, continued

Column Name	Constraint	Column Type	Description
escalate_flag	N	number(3)	Reserved for future use. Filter out all except escalation messages: Yes/No.
forward_flag	N	number(3)	Reserved for future use. Filter out all except forwarded messages: Yes/No.
readonly_flag	N	number(3)	Reserved for future use. Filter out all except messages marked as read only: Yes/No.
sort	N	number(3)	Sorting order of messages. Possible values: 0...Date/Time 1...Node 2...Message Group 3...Application 4...Severity
ownership	N	number(3)	Display messages filtered by the state of the ownership. Possible values: 1...Unowned 2...Owned by me 4...Owned by someone else To filter for more than one state of ownership, use a logical OR.

opc_op_browser_set Table, continued

Column Name	Constraint	Column Type	Description
sort_cma_name	N	varchar2(508)	Reserved for future use. Custom message attribute name to sort by, if set.
unbuffer_time_from	N	number12	Start of desired unbuffer time frame.
unbuffer_time_to	N	number12	End of desired unbuffer time frame.
time_last_rec_from		number12	Reserved for future use.
time_last_rec_to		number12	Reserved for future use.
time_owned_from		number12	Reserved for future use.
time_owned_to		number12	Reserved for future use.
dup_count		number12	Reserved for future use.
readonly_status		number3	Reserved for future use.
instruction_type		number3	Reserved for future use.
auto_status		number3	Reserved for future use.
oper_init_status		number3	Reserved for future use.
annotation_count		number12	Reserved for future use.
on_counters_mode		number12	Reserved for future use.

opc_op_browser_set_cma Table

This table contains the object list of the custom message attribute name and value pairings for an operator's saved browser settings. There is one entry for each custom message attribute pairing within each browser setting.

Table 14: opc_op_browser_set_cma Table

Column Name	Constraint	Column Type	Description
user_id	N	varchar2(36)	Key field to identify the user.
setting_name	N	varchar2(254)	Key field to identify the browser setting.
cma_name	N	varchar2(508)	Name of the custom message attribute.
cma_value	N	varchar2(2048)	Value of the custom message attribute.

opc_op_browser_set_obj Table

This table contains the object list of an operator's saved browser settings. There is one entry for each browser setting. This is the content of the On Selected Symbols list box.

Table 15: opc_op_browser_set_obj Table

Column Name	Constraint	Column Type	Description
user_id	N, P	varchar2(36)	Key field to identify the user.
setting_name	N, P	varchar2(64)	Key field to identify the browser setting.
object_type	N, P	number(5)	Type of object. Possible values: 1...Node 8...Message Group 13...Service Name (Reserved for future use.) 14...Message Type (Reserved for future use.) 16...Application 64...Object 128...External Node
object_name	N, P	varchar2(508)	Name of the object.

opc_op_defaults Table

This table contains the default settings of browsers for individual HPOM users. These settings include browser's size and the selection of columns to be displayed.

Table 16: opc_op_defaults Table

Column Name	Constraint	Column Type	Description
user_id	N, P	varchar2(36)	Key field to identify the user.
act_browser_x	N	number(12)	Last on-screen x position of active message browser.
act_browser_y	N	number(12)	Last on-screen y position of active message browser window.
act_browser_heig	N	number(12)	Last on-screen height of active message browser.
act_browser_width	N	number(12)	Last on-screen width of active message browser window.
act_header_flag	N	number(3)	Header line visible: Yes/No.
act_sever_flag	N	number(3)	Severity column visible: Yes/No.
act_unmatch_flag	N	number(3)	Unmatched column visible: Yes/No.
act_instr_flag	N	number(3)	Instruction column visible: Yes/No.
act_auto_flag	N	number(3)	Automatic action status column visible: Yes/No.
act_oper_flag	N	number(3)	Operator-initiated action status column visible: Yes/No.
act_note_flag	N	number(3)	Annotation column visible: Yes/No.
act_date_flag	N	number(3)	Date column visible: Yes/No.
act_time_flag	N	number(3)	Time column visible: Yes/No.
act_node_flag	N	number(3)	Node column visible: Yes/No.

opc_op_defaults Table, continued

Column Name	Constraint	Column Type	Description
act_applic_flag	N	number(3)	Application column visible: Yes/No.
act_msggrp_flag	N	number(3)	Message group column visible: Yes/No.
act_object_flag	N	number(3)	Object column visible: Yes/No.
act_escal_flag	N	number(3)	Escalated: Yes/No.
act_assign_flag	N	number(3)	Assigned: Yes/No.
act_dupl_flag	N	number(3)	Duplicate count column visible: Yes/No.
hist_browser_x	N	number(12)	Last on-screen x position of history browser.
hist_browser_y	N	number(12)	Last on-screen y position of history browser.
hist_browser_ heig	N	number(12)	Last on-screen height of history browser.
hist_browser_ width	N	number(12)	Last on-screen width of history browser.
hist_header_flag	N	number(3)	Header line visible: Yes/No.
hist_sever_flag	N	number(3)	Severity column visible: Yes/No.
hist_unmatch_ flag	N	number(3)	Unmatched column visible: Yes/No.
hist_instr_flag	N	number(3)	Instruction column visible: Yes/No.
hist_auto_flag	N	number(3)	Automatic action status column visible: Yes/No.
hist_oper_flag	N	number(3)	Operator initiated-action status column visible: Yes/No.
hist_note_flag	N	number(3)	Annotation column visible: Yes/No.
hist_date_flag	N	number(3)	Date column visible: Yes/No.
hist_time_flag	N	number(3)	Time column visible: Yes/No.
hist_node_flag	N	number(3)	Node column visible: Yes/No.

opc_op_defaults Table, continued

Column Name	Constraint	Column Type	Description
hist_applic_flag	N	number(3)	Application column visible: Yes/No.
hist_msggrp_flag	N	number(3)	Message group column visible: Yes/No.
hist_object_flag	N	number(3)	Object column visible: Yes/No.
hist_escal_flag	N	number(3)	Escalated: Yes/No.
hist_assign_flag	N	number(3)	Assigned: Yes/No.
hist_dupl_flag	N	number(3)	Duplicate count column visible: Yes/No.
view_browser_x	N	number(12)	Last on-screen x position of view browser.
view_browser_y	N	number(12)	Last on-screen y position of view browser.
view_browser_ heig	N	number(12)	Last on-screen height of view browser.
view_browser_ width	N	number(12)	Last on-screen width of browser window.
view_header_ flag	N	number(3)	Header line visible: Yes/No.
view_sever_flag	N	number(3)	Severity column visible: Yes/No.
view_unmatch_ flag	N	number(3)	Unmatched column visible: Yes/No.
view_instr_flag	N	number(3)	Instruction column visible: Yes/No.
view_auto_flag	N	number(3)	Automatic action status column visible: Yes/No.
view_oper_flag	N	number(3)	Operator-initiated action status column visible: Yes/No.
view_note_flag	N	number(3)	Annotation column visible: Yes/No.
view_date_flag	N	number(3)	Date column visible: Yes/No.
view_time_flag	N	number(3)	Time column visible: Yes/No.
view_node_flag	N	number(3)	Node column visible: Yes/No.

opc_op_defaults Table, continued

Column Name	Constraint	Column Type	Description
view_applic_flag	N	number(3)	Application column visible: Yes/No.
view_msggrp_flag	N	number(3)	Message group column visible: Yes/No.
view_object_flag	N	number(3)	Object column visible: Yes/No.
view_escal_flag	N	number(3)	Escalated: Yes/No.
view_assign_flag	N	number(3)	Assigned: Yes/No.
view_dupl_flag	N	number(3)	Duplicate count column visible: Yes/No.
pend_browser_x	N	number(12)	Last on-screen x position of pending message browser.
pend_browser_y	N	number(12)	Last on-screen y position of pending message browser.
pend_browser_heig	N	number(12)	Last on-screen height of pending message browser.
pend_browser_width	N	number(12)	Last on-screen width of pending message browser.
pend_header_flag	N	number(3)	Header line visible: Yes/No.
pend_sever_flag	N	number(3)	Severity column visible: Yes/No.
pend_unmatch_flag	N	number(3)	Unmatched column visible: Yes/No.
pend_instr_flag	N	number(3)	Instruction column visible: Yes/No.
pend_auto_flag	N	number(3)	Automatic action status column visible: Yes/No.
pend_oper_flag	N	number(3)	Operator-initiated action status column visible: Yes/No.
pend_note_flag	N	number(3)	Annotation column visible: Yes/No.
pend_date_flag	N	number(3)	Date column visible: Yes/No.

opc_op_defaults Table, continued

Column Name	Constraint	Column Type	Description
pend_time_flag	N	number(3)	Time column visible: Yes/No.
pend_node_flag	N	number(3)	Node column visible: Yes/No.
pend_applic_flag	N	number(3)	Application column visible: Yes/No.
pend_msggrp_flag	N	number(3)	Message group column visible: Yes/No.
pend_object_flag	N	number(3)	Object column visible: Yes/No.
pend_escal_flag	N	number(3)	Escalate: Yes/No.
pend_assign_flag	N	number(3)	Assign: Yes/No.
pend_dupl_flag	N	number(3)	Duplicate count column visible: Yes/No.

opc_op_desk Table

This table represents the application desktop of an HPOM user. It contains the top-level applications that are directly assigned to that user.

Table 17: opc_op_desk Table

Column Name	Constraint	Column Type	Description
user_id	N, P, F	varchar2(36)	Key field to identify the user.
application_id	N, P, F	varchar2(36)	Key field to identify the application.

opc_op_group_desk Table

This table represents the application-group desktops of an HPOM user. Only the top level application groups are shown. When an application group is assigned to an operator, the operator inherits also the application groups contained within this application group.

The complete desktop of an operator is created with the tables `opc_op_desk` (Table 17), `opc_op_group_desk` (Table 18), `opc_appl_in_group` (Table 5), and `opc_applgrp_in_grp` (Table 9).

Table 18: opc_op_group_desk Table

Column Name	Constraint	Column Type	Description
user_id	N, P, F	varchar2(36)	Key field to identify the user.
appl_group_id	N, P, F	varchar2(36)	Key field to identify the application group.

opc_op_profiles Table

This table contains details of assignments between user profiles, or user profiles and users.

Table 19: opc_op_profiles Table

Column Name	Constraint	Column Type	Description
user_id	N, F, U	varchar2(36)	Key field to identify the user or user profile.
profile_id	N, F, U	varchar2(36)	Key field to identify the user profile assigned to the above user or user profile.

opc_op_realm Table

This table represents the responsibility matrix of the operators. The responsibility matrix is built by pairs of message groups and node groups.

Table 20: opc_op_realm Table

Column Name	Constraint	Column Type	Description
user_id	N, U, F	varchar2(36)	Key field to identify the user.
node_group_id	N, U, F	varchar2(36)	Key field to identify the node group.
msg_group_name	N, U, F	varchar2(254)	Key field to identify the message group.
read_only		number(3)	Flag for read-only responsibility matrix.

opc_op_services Table

This table contains operator and service assignment combinations. The content of the table is dynamic, it exists only at runtime.

Note: This table is for internal use only.

Table 21: opc_op_services Table

Column Name	Constraint	Column Type	Description
user_id	N, P, F	varchar2(36)	Key field to identify the user.
service_name	N, P	varchar2(4000)	Field to identify the service.

opc_user_data Table

This table contains the main details about configured users and user profiles.

Table 22: opc_user_data Table

Column Name	Constraint	Column Type	Description
user_id	N, P	varchar2(36)	Key field to identify the user in other tables.
symbol_type_id	N	varchar2(36)	Key field to identify the symbol type.
nodehier_id	F	varchar2(36)	Node hierarchy assigned to this operator.
user_role	N	number(3)	Role of the user: operator, administrator. Possible values: 0...Operator 1...Administrator 3...Policy administrator 4...User profile
name	U, N	varchar2(128)	HPOMuser or user profile name.
password		varchar2(80)	Hexadecimal representation of the encrypted password.
realname		varchar2(128)	The HPOM user's real name.
description		varchar2(508)	Description of tasks and role assigned to this HPOM user.

opc_user_data Table, continued

Column Name	Constraint	Column Type	Description
label		varchar2(508)	Label of the user (displayed in the Java GUI or the Administration UI).
see_all		number(3)	Reserved for future use.
info		varchar(4000)	Field for the operator's notes, for example, for tracking changes.

Chapter 4: Node Tables

In This Chapter

This chapter contains the node tables.

opc_category Table

This table stores the general information about categories.

Table 23: opc_category Table

Column Name	Constraint	Column Type	Description
category_id	N, P	varchar2(36)	Key field to identify the category.
category_name	N, U	varchar2(1024)	Name of the category.
category_description		varchar2(1024)	Description of the category.

opc_chsets Table

This table stores the possible character sets of a platform. It belongs to the table `opc_net_machine` (Table 27) which contains the main entry for an agent platform.

Table 24: opc_chsets Table

Column Name	Constraint	Column Type	Description
network_type	N, P	number(5)	Type of network the node resides in. Possible values: 0...No node 1...IP 5...Other

opc_chsets Table , continued

Column Name	Constraint	Column Type	Description
machine_type	N, P	number(5)	Network_type and machine_type identify the platform. Several character sets are allowed for one platform.
chset_number	N, P	number(3)	Encoding of character set. Possible values are: 0...ASCII 1...ISO88591 2...ROMAN8 4...ACP1252 (Windows ANSI code page for Western Europe (Latin)) 28...ISO885915 64...SJIS (Japanese SJIS) 65...EUCJP (Japanese EUC) 66...ACP932 (Windows ANSI code page for Japan)

opc_comm_type Table

This table stores the possible communication types of a platform. It belongs to the `opc_net_machine` table (Table 27) that contains the main entry for an agent platform.

Table 25: opc_comm_type Table

Column Name	Constraint	Column Type	Description
network_type	N, P	number(5)	Type of network the node resides in. Possible values: 0...No node 1...IP 5...Other

opc_comm_type Table, continued

Column Name	Constraint	Column Type	Description
machine_type	N, P	number(5)	Network_type and machine_type identify the platform. Several communication types are allowed for one platform.
comm_type	N, P	number(3)	Communication type. Possible values are: 0...Unspecified communication type 1...NCS* 2...DCE TCP* 3...DCE UDP* 4...Sun RPC, TCP* 5...SUN RPC, UDP* 6...TCP Socket* 7...UDP Socket* 8...OPC Interface* 9...RPC Local* 10...HTTPS * Obsolete with HPOM 9.xx.

opc_mgmtsv_config Table

This table contains the global configuration of the management server.

Table 26: opc_mgmtsv_config Table

Column Name	Constraint	Column Type	Description
node_id	N	varchar2(36)	Key field for node identification of management server.
charset	N	number(3)	Management server character set that is set at installation time to an appropriate value for the particular language.

opc_mgmtsv_config Table, continued

Column Name	Constraint	Column Type	Description
parallel_distrib	N	number(3)	Number of parallel distributions that may run at one time.
trace_flag	N	number(3)	Management server tracing.
message_if_enable	N	number(3)	Message Stream Interface enabled: Yes/No.
msg_if_allow_aa	N	number(3)	Allow definition of automatic actions through Message Stream Interface: Yes/No.
msg_if_allow_oa	N	number(3)	Allow definition of operator-initiated actions through Message Stream Interface: Yes/No.
glob_sec_level	N	number(12)	Global DCE Security level (obsolete with HPOM 9.xx).
port_range		varchar2(160)	Port range for DCE communication (obsolete with HPOM 9.xx).
output_all_to_msi	N	number(3)	Output all messages to the MSI (not only those which are configured in the policies). Possible values: 0...No output 1...Output messages in divert mode 2...Output messages in copy mode
msg_dupl_counting	N	number(3)	Duplicate message suppression and counting is enabled: Yes/No.
add_count_annotations	N	number(3)	Annotations of duplicate messages are added to the original message if duplicate suppression and counting is enabled: Yes/No.

opc_mgmtsv_config Table, continued

Column Name	Constraint	Column Type	Description
user_login_auth	N	number(3)	Reserved for future use. The login authentication is to be applied to all users. Possible values: 0...Internal (default) 1...UNIX only
ovou_license_flag		number(3)	If set to 1, display GUI startup confirmation dialog. If set to 0, do not ask before execution.
ovou_license_text		varchar2(4000)	License agreement text to be shown.
opccfgupld_active		number(12)	Indicates whether opccfgupld is running.
opccfgupld_mode		number(12)	Reserved for future use.
opccfgupld_area		number(12)	Reserved for future use. Indicates the area that is currently being updated by opccfgupld.
s2s_sync_buf_state		number(3)	Reserved for future use.

opc_net_machine Table

This table contains the main details for agent platforms available on the management server. It is used to display the platform name and to define possible values. The values are defined in the Agent Platform files which can be loaded using `opcagtdbcfg (1M)`.

The table also contains information about proxy capabilities for a platform. (This information is reserved for future use.)

Table 27: opc_net_machine Table

Column Name	Constraint	Column Type	Description
network_type	N, P	number(5)	Type of network the node resides in. Possible values: 0...No node 1...IP 5...Other
machine_type	N, P	number(5)	A unique identifier for a combination of hardware and operating system.
sw_install	N	number(3)	Software installation is possible: Yes/No.
agent_type	N	number(5)	Description of licensing used.
satellite_depot	N	number(3)	Indicates whether platform supports satellite depots: Yes/No.
sd_installable	N	number(3)	Indicates whether SD based installation is also available: Yes/No.
controlled_allowed	N	number(3)	CONTROLLED node type allowed: Yes/No.
monitored_allowed	N	number(3)	MONITORED node type allowed: Yes/No.
message_allowed	N	number(3)	MESSAGE_ALLOWED node type allowed: Yes/No.
sys_descr		varchar2(254)	Search string used to identify machine type under SNMP.
platform_selector		varchar2(90)	Platform selector in the format "vendor/hardware/OS". For example, "hp/s700/hp-ux10". This information is loaded through the Agent Platform Files. The platform selector identifies the platform when using opcgutil or opcgtdbcfg.
network_type_str		varchar2(48)	Network name (for example, IP Network).

opc_net_machine Table, continued

Column Name	Constraint	Column Type	Description
machine_type_str		varchar2(40)	Machine name (for example, Sun SPARC station).
os_name		varchar2(40)	Operating system name (for example, Solaris).
os_family		varchar2(1024)	Operating system family (for example, Unix).
os_type		varchar2(1024)	Operating system type (for example, HP-UX).
cpu_type		varchar2(1024)	Central processing unit type (for example, Intel).
pltf_abs_name		varchar2(1024)	Holds the platform strings for assigning categories.
satellite_depot	N	number(3)	Indicates whether platform supports satellite depots: Yes/No.
pltfm_family_name	N	varchar2(64)	Name of the group of platforms with the same login attributes. Possible values are: <ul style="list-style-type: none"> • MPE • MS • NetWare • OS/2 (For HP internal use only.) • UNIX New values can be loaded using the Agent Platform Files.
controlled_allowed	N	number(3)	CONTROLLED node type allowed: Yes/No.
monitored_allowed	N		MONITORED node type allowed: Yes/No.

opc_net_machine Table, continued

Column Name	Constraint	Column Type	Description
node_name_in_path	N	number(3)	Combine path names with the node name: Yes/No.
rlogin_method	N	number(3)	One of RLOGIN, TELNET, VT3K, LOGIN_SCRIPT. Possible values: 1...RLOGIN 2...TELNET 3...VT3K 4...LOGIN_SCRIPT
rlogin_script		varchar2(28)	Name of the script.
restr_add_param	N	number(3)	Used when specifying additional path names for applications: Yes/No.
custom_stream_cmd	N	number(3)	MPE/iX specific: when this value is set, MPE_JOB_STREAM is used: Yes/No.
heartbeat_polling	N	number(3)	Indicates whether heartbeat polling is possible: Yes/No.
agent_control	N	number(3)	Agents can be started remotely: Yes/No.
templ_distr_method	N	number(3)	Method for distributing policies. Possible values are: 1...No policy distribution 2...HPOM method (default) 3...OPC_INTERFACE
templ_assignment	N	number(3)	Policies can be assigned: Yes/No.
logfile_templates	N	number(3)	LOGFILE policies can be assigned: Yes/No.
node_name_function		varchar2(28)	Used by MPE/iX for the node name resolution.

opc_net_machine Table, continued

Column Name	Constraint	Column Type	Description
login_prompt		varchar2(64)	Login prompt string used at remote login.
password_prompt		varchar2(64)	Password prompt used at remote login.
login_incorrect		varchar2(64)	Incorrect login prompt used at remote login.
conn_failed		varchar2(64)	Remote connection failed prompt used at remote login.
term_appl_path		varchar2(508)	Additional search paths for input/output applications. These are added to the \$PATH variable.
monitor_templates	N	number(3)	MONITOR policies can be assigned: Yes/No.
opcmsg_templates	N	number(3)	OPCMMSG policies can be assigned: Yes/No.
trap_templates	N	number(3)	TRAP policies can be assigned: Yes/No.
console_templates	N	number(3)	CONSOLE policies can be assigned: Yes/No.
ecs_templates	N	number(3)	Event correlation circuits can be assigned: Yes/No.
ecs_gui	N	number(3)	Event correlation GUI available for this platform: Yes/No.
sched_templates	N	number(3)	Scheduled action policies can be assigned to the nodes of this platform: Yes/No.
trapi_on_srv_only	N	number(3)	Event interceptor agent on the management server only: Yes/No.
virtual_console	N	number(3)	Set when virtual terminal is possible: Yes/No.
physical_console	N	number(3)	Physical terminal is possible: Yes/No.
cmd_broadcast	N	number(3)	Command broadcasting is possible: Yes/No.

opc_net_machine Table, continued

Column Name	Constraint	Column Type	Description
operator_actions	N	number(3)	Operator-initiated actions are possible: Yes/No.
appl_input_output	N	number(3)	Applications of type input_output are possible: Yes/No.
appl_output_only	N	number(3)	Applications of type output_only are possible: Yes/No.
appl_no_output	N	number(3)	Applications of type no_output are possible: Yes/No.
interface_instance		varchar2(28)	Name of the interface if the communication type OPC_INTERFACE is used.
ov_application	N	number(3)	OV applications supported on platform: Yes/No.
depot_ftp_method	N	number(3)	Satellite Depot access by FTP: Yes/No.
depot_rcp_method	N	number(3)	Satellite Depot access by RCP: Yes/No.
depot_sd_method	N	number(3)	Satellite Depot access by SD: Yes/No.
ssh_method		number(3)	Access to managed node by SSH: Yes/No.
package_type		varchar2(160)	Directory extension to an agent package for the installation (for communication type dependent package).
agent_type_name		varchar2(64)	Name of the HPOM agent type.
proxy_family		varchar2(32)	String to identify a proxy family.
proxied_agent_type_name		varchar2(64)	Name of the proxied agent type.
proxied_family		varchar2(32)	String to identify a proxy family.

opc_net_machine Table, continued

Column Name	Constraint	Column Type	Description
agent_type_number	N	number(3)	An agent type.
proxy_control	N	number(3)	This field is not used in the current release.
proxy_hbp	N	number(3)	This field is not used in the current release.
proxy_sw_install	N	number(3)	Indicates whether the installation and the deployment are performed through proxy (TRUE and FALSE values).
proxy_control	N	number(3)	Contains bitmask that defines the possible control operations of the proxy node. Possible values: 0...No 1...Start 2...Stop 4...Status 8...Update Any binary combination of the values is possible.
proxy_hbp	N	number(3)	Heartbeat polling to proxy node: Yes/No.
proxy_sw_install	N	number(3)	Software installation of proxy node from HPOM manager possible: Yes/No.
proxy_communication	N	number(3)	Communication to proxy node configurable: Yes/No.
proxy_mom	N	number(3)	MoM functionality available on proxy node: Yes/No.
proxy_msi	N	number(3)	MSI available on proxy node: Yes/No.
proxy_logging	N	number(3)	Logging directory and size configurable for proxy: Yes/No.

opc_net_machine Table, continued

Column Name	Constraint	Column Type	Description
proxy_charset	N	number(3)	Character set of the proxy node. Possible values are: 0...ASCII 1...ISO88591 2...ROMAN8 4...ACP1252 (Windows ANSI code page for Western Europe (Latin)) 28...ISO885915 64...SJIS (Japanese SJIS) 65...EUCJP (Japanese EUC) 66...ACP932 (Windows ANSI code page for Japan)
proxy_need_nodeinfo	N	number(3)	Proxy node needs nodeinfo: Yes/No.
proxied_supported	N	number(3)	Does the platform support proxied nodes: Yes/No.
proxied_agent_type_nr	N	number(3)	Number to be used as agent type for the proxied node. Possible values: 0...HPOM
proxy_supported	N	number(3)	Does the platform support proxy nodes: Yes/No.

opc_net_machine Table, continued

Column Name	Constraint	Column Type	Description
proxied_control	N	number(3)	Contains bitmask that defines the possible control operations of the proxied node. Possible values: 0...No 1...Start 2...Stop 4...Status 8...Update
proxied_hbp	N	number(3)	Heartbeat polling to proxied node possible: Yes/No.
proxied_sw_install	N	number(3)	Software installation of proxied node from HPOM manager possible: Yes/No.
proxied_communication	N	number(3)	Communication to proxied node configurable.
proxied_mom	N	number(3)	MoM functionality available on proxied node: Yes/No.
proxied_need_nodeinfo	N	number(3)	Defines whether the proxied node needs a nodeinfo file: Yes/No.
proxied_msi	N	number(3)	MSI available on proxied node: Yes/No.
proxied_logging	N	number(3)	Logging directory and size configurable for proxies: Yes/No.
proxied_tmpl_distr_meth	N	number(3)	Method for distributing policies. Possible values are: 1...No policy distribution 2...HPOM method (default) 3...OPC_INTERFACE

opc_net_machine Table, continued

Column Name	Constraint	Column Type	Description
proxied_tmpl_assignment	N	number(3)	Can policies be assigned: Yes/No.
proxied_logfile_tmpl	N	number(3)	LOGFILE policies can be assigned: Yes/No.
proxied_monitor_tmpl	N	number(3)	MONITOR policies can be assigned: Yes/No.
proxied_opcmsg_tmpl	N	number(3)	OPCMMSG policies can be assigned: Yes/No.
proxied_trap_tmpl	N	number(3)	TRAP policies can be assigned: Yes/No.
proxied_console_tmpl	N	number(3)	CONSOLE policies can be assigned: Yes/No.
proxied_ecs_tmpl	N	number(3)	Event correlation circuits can be assigned: Yes/No.
proxied_sched_tmpl	N	number(3)	Schedule policies can be assigned to nodes of this platform: Yes/No.
proxied_virtual_console	N	number(3)	Virtual terminal possible: Yes/No.
proxied_physical_console	N	number(3)	Physical terminal possible: Yes/No.
proxied_cmd_broadcast	N	number(3)	Broadcast applications possible: Yes/No.
proxied_operator_actions	N	number(3)	HPOMoperator-initiated actions possible: Yes/No.
proxied_appl_in_out	N	number(3)	Applications of type input output possible: Yes/No.
proxied_appl_output_only	N	number(3)	Applications of type output only possible: Yes/No.

opc_net_machine Table, continued

Column Name	Constraint	Column Type	Description
proxied_appl_no_output	N	number(3)	Applications of type no output possible: Yes/No.
proxied_binary_distr	N	number(3)	Distribution of action/cmd/monitor scripts possible: Yes/No.
proxied_oa_sw_install	N	number(3)	Open agent installation methods supported: Yes/No.
proxied_oa_control	N	number(3)	Open agent control methods supported: Yes/No.
proxied_oa_send	N	number(3)	Open agent send data methods supported: Yes/No.
proxied_ctrl_allowed	N	number(3)	Node type CONTROLLED allowed for proxied nodes: Yes/No.
proxied_mon_allowed	N	number(3)	Node type MONITORED allowed for proxied nodes: Yes/No.
proxied_message_allowed	N	number(3)	Node type MESSAGE_ALLOWED possible for proxied nodes: Yes/No.

opc_net_machine Table, continued

Column Name	Constraint	Column Type	Description
proxied_charset	N	number(3)	Character set of the proxied node. Possible values are: 0...ASCII 1...ISO88591 2...ROMAN8 4...ACP1252 (Windows ANSI code page for Western Europe (Latin)) 28...ISO885915 64...SJIS (Japanese SJIS) 65...EUCJP (Japanese EUC) 66...ACP932 (Windows ANSI code page for Japan)
proxied_action_exec	N	number(3)	Execution of actions allowed: Yes/No.
agent_type_number	N	number(3)	Number to be used as agent type for the HPOM agent.
dhcp_allowed	N	number(3)	0 = No (default). 1 = Yes.
package_type		varchar2(160)	Package type associated with this platform.
ip_flags	N	number(5)	Copy from opcnodes, add 0x0040 Uses IPV6 (also on opc_nodes)
lcore_os_type_num		number(5)	Internal L-core numbers to identify an os type.
lcore_cpu_type_num		number(5)	Internal L-core numbers to identify a CPU type.

opc_net_sec_types Table

This table contains a list of possible NSP (Network Security Protocol) security types for the platform identified by network_type and machine_type (see "[opc_net_machine Table](#)" on page 49).

Table 28: opc_net_sec_types Table

Column Name	Constraint	Column Type	Description
network_type	N, P	number(5)	Key field (part 1).
machine_type	N, P	number(5)	Key field (part 2).
net_security_type	N, P	number(3)	NSP security type. Possible values: 0...None 2...Secret key 3...For HP internal use only. 4...GSS_API_V2

opc_node_alt_addr Table

Note: [Table 29](#) is reserved for future use.

This table contains aliases or alternate IP addresses of a node. A node can use several aliases or alternate IP addresses, or several nodes can use the same alias or the same alternate IP address. However, each combination of node_id and alt_ip_addr must be unique.

Table 29: opc_node_alt_addr Table

Column Name	Constraint	Column Type	Description
node_id	U, N	varchar2(36)	Key field to identify the node.
alt_ip_addr	U, N	number(12)	An alias or an alternate IP address of the node.

opc_node_alt_name Table

Note: Table 30 is reserved for future use.

This table contains aliases or alternate IP names of a node, if defined. A node can use several aliases or alternate IP names, or several nodes can use the same alias or the same alternate IP name. However, each combination of node_id and alt_ip_name must be unique.

Table 30: opc_node_alt_name Table

Column Name	Constraint	Column Type	Description
node_id	U, N	varchar2(36)	Key field to identify the node.
alt_ip_name	U, N	varchar2(508)	An alias or an alternate name of the node.

opc_node_alt_v6_addr Table

Note: Table 31 is reserved for future use.

This table contains aliases or alternate IPv6 addresses of a node. A node can use several aliases or alternate IPv6 addresses, or several nodes can use the same alias or the same alternate IPv6 address. However, each combination of node_id and alt_ip_addr must be unique.

Table 31: opc_node_alt_v6_addr Table

Column Name	Constraint	Column Type	Description
node_id	U, N, F	varchar2(36)	Key field to identify the node.
alt_ipv6_addr	U, N	varchar2(39)	An alias or an alternate IPv6 address (full form) of the node.

opc_node_cat Table

This table stores the information on links between nodes and categories.

Table 32: opc_node_cat Table

Column Name	Constraint	Column Type	Description
node_id	N, F, P	varchar2(36)	Key field to identify the node.

opc_node_cat Table, continued

Column Name	Constraint	Column Type	Description
category_id	N, F, P	varchar2(36)	Key field to identify the category.

opc_node_cat_config Table

This table stores the configuration information for categories on particular nodes.

Table 33: opc_node_cat_config Table

Column Name	Constraint	Column Type	Description
node_id	N, P, F	varchar2(36)	Key field to identify the node.
category_id	N, P, F	varchar2(36)	Key field to identify the category.
node_ref_count		number(12)	Used for assigning and deassigning categories to nodes without having a policy reference.
policy_ref_count		number(12)	Used for assigning and deassigning policies to nodes, and adding or deleting categories from policies.
last_cat_distrib		date	Date of the last category distribution.

opc_node_defaults Table

This table contains the default values of an agent platform, as given in the Agent Platform Files. These defaults can be changed using the Java GUI or the Administration UI. They apply when a node of that particular platform type is added. The values are loaded together with the unalterable platform data using `opcagtdbcfg(1M)`.

Table 34: opc_node_defaults Table

Column Name	Constraint	Column Type	Description
network_type	N, P	number(5)	Type of network the node resides in.
machine_type	N, P	number(5)	Type of machine hardware and the operating system.

opc_node_defaults Table, continued

Column Name	Constraint	Column Type	Description
terminal	N	number(3)	Type of terminal connection used to access the node. Possible values are: 0...hpterm 1...xterm 2...dtterm 3...none
node_type	N	number(3)	Role of node within HPOM. Possible values are: 1...Disabled 2...Controlled 3...Monitored 4...Message Allowed
auto_sw_inst_flag	N	number(3)	Distribute HPOM software automatically: Yes/No.
auto_res_mod_flag	N	number(3)	Automatically update system resource files: Yes/No.
maximum_size	N	number(12)	Limit in KByte the logging information may occupy.
logging_directory		varchar2(508)	Path to directory where HPOM stores local logging information.
console_path		varchar2(508)	Program call to establish connection to physical console port.
heartbeat_interval		varchar2(32)	Time interval between heartbeat polls. Format: 1h20m10s.
node_char_set	N	number(3)	Character set used for the node.
default_font		varchar2(264)	Font used for X Applications started from the node.

opc_node_defaults Table, continued

Column Name	Constraint	Column Type	Description
trace_flag	N	number(3)	Agent tracing.
ncs_pckg_size	N	number(12)	The NCS RPC package size used for communication with the node (obsolete with HPOM 9.xx).
ncs_delay	N	number(3)	Delay between NCS RPC calls (obsolete with HPOM 9.xx).
heartbeat_retry	N	number(3)	Polling frequency of the node.
mpe_job_stream		varchar2(160)	The name of the MPE Job Stream Facility used.
console_par1		varchar2(80)	1st physical console parameter.
console_par2		varchar2(80)	2nd physical console parameter.
console_par3		varchar2(80)	3rd physical console parameter.
resolve_mode	N	number(3)	IP address resolution mode. Possible values are: 0...auto 1...static
message_if_enable	N	number(3)	Message Stream Interface enabled: Yes/No.
msg_if_allow_aa	N	number(3)	Allow definition of automatic actions through Message Stream Interface: Yes/No.
msg_if_allow_oa	N	number(3)	Allow definition of operator-initiated actions through Message Stream Interface: Yes/No.
symbol_type_id	N	varchar2(36)	Symbol_type_id of default symbol type.
depot_node_id	N	varchar2(36)	Node where agent package is stored: management server name by default.

opc_node_defaults Table, continued

Column Name	Constraint	Column Type	Description
inst_method	N	number(3)	The method of installation. Possible values are: 0...HPOM installation 1...SD installation 2...Asynchronous HPOM installation 3...Asynchronous SD installation
depot_access_meth	N	number(3)	Default access method for satellite depots. Possible values are: 1...FTP 2...SD 3...RCP 4...SSH
package_name		varchar2(508)	Name of package for satellite depots. (This is not currently in use).
depot_name		varchar2(508)	Name of depot for SD installation.
compr_pkg_trans	N	number(3)	Use compressed package transfer with SD: Yes/No.
compr_pkg	N	number(3)	Use compressed packages for SD installation. (This is currently not in use.)
inst_user		varchar2(128)	The installation user is usually the root user. Can be modified by the HPOM administrator by using the Java GUI or the Administration UI.
comm_type	N	number(3)	Default communication method (HTTPS).
port_range		varchar2(160)	Port range for DCE* on managed node. * The DCE agent is obsolete with HPOM 9.xx.

opc_node_defaults Table, continued

Column Name	Constraint	Column Type	Description
comm_attr	N	number(12)	Communication attributes (DCE* security level). Possible values are: 0...None 1...Auth. connect 2...Auth. call 3...Auth. pkt 4...Pkt integer 5...Pkt encrypt * The DCE agent is obsolete with HPOM 9.xx.
heartbeat_type	N	number(3)	Used heartbeat polling method. Possible values are: 0...None 1...RPC only 2...Ping only 3...Ping and RPC 4...From agent 5...From agent and RPC 6...From agent and ping 7...From agent and RPC and ping
security_type	N	number(3)	Used security type for Network Security Protocol. For HP Advanced Security only. Possible values are: 0...None 2...Secret key 3...For HP internal use only. 4...GSS_API_V2

opc_node_defaults Table, continued

Column Name	Constraint	Column Type	Description
agent_type_number	N	number(3)	Number to be used as default agent type.
proxy_name		varchar2(2048)	Name of the proxy node that is used to manage the proxied node.
buflim_enable	N	number(3)	Agent buffer size limitation enabled: Yes/No.
buflim_size	N	number(12)	Maximum size of the agent message buffer (in bytes).
buflim_severity	N	number(3)	Minimum severity of the messages to be buffered in case of buffer size conflicts. Possible values are: 0...None 2...Normal 4...Warning 16...Minor 32...Major 8...Critical
agt_inst_dir		varchar2(508)	Directory where the agent is installed.
ipce_allowed	N	number(3)	Indicates whether IPCE is allowed by default. 0 - No 1 - Yes
dhcp_allowed	N	number(3)	Indicates whether DHCP is allowed by default. 0 - No 1 - Yes
ip_flags	N	number(5)	Copy from opcnodes, add 0x0040 Uses IPV6 (also on opc_nodes)

opc_nodegrp_cat Table

Note: Table 35 is reserved for future use.

This table stores the information on links between node groups and categories.

Table 35: opc_nodegrp_cat Table

Column Name	Constraint	Column Type	Description
node_group_id	N, P, F	varchar2(36)	Key field to identify the node group.
category_id	N, P, F	varchar2(36)	Key field to identify the category.

opc_node_groups Table

This table contains all node groups.

Table 36: opc_node_groups Table

Column Name	Constraint	Column Type	Description
node_group_id	N, P	varchar2(36)	Key field to identify node groups in other tables.
parent_id	U	varchar2(36)	Key field to identify the parent node group. If the parent_id is null, this node group is in the top level.
symbol_type_id	N	varchar2(36)	Key field to identify the symbol type string in opc_symbols.
node_group_name	U	varchar2(2048)	Name of the node group.
description		varchar2(508)	Description of the node group.
label		varchar2(508)	Label of the node group that appears in the Java GUI or the Administration UI.

opc_node_groups Table, continued

Column Name	Constraint	Column Type	Description
invisible	N	number(3)	This flag indicates the visibility of a node group in the responsibility matrix of an operator. Possible values are: 0...Visible (default) 1...Invisible (obsolete with HPOM 9.xx) 2...Virtual node
info		varchar2(4000)	Field for the operator's notes, for example, for tracking the changes.

opc_node_names Table

This table contains the IP addresses (if the node is connected to the network) and node names. These IP addresses belong either to normal nodes in `opc_nodes` (see [Table 41](#)) or to external nodes from which the messages are coming. The latter are referenced in [Table 76](#) and [Table 84](#).

Table 37: opc_node_names Table

Column Name	Constraint	Column Type	Description
node_id	P, N	varchar2(36)	Key field to identify the node.
network_type	N	number(5)	Type of network the node resides in. Possible values: 0...No node 1...IP 5...Other 6...Unknown
ip_address	N	number(12)	An IPv4 address of the node, if it is an IP node.

opc_node_names Table, continued

Column Name	Constraint	Column Type	Description
ipv6_address		varchar2(39)	Reserved for future use. An IPv6 address (full form) of the node.
node_name	U	varchar2(2048)	Name of the node. This is the name returned by the name service, ideally fully qualified domain name.
ip_flags	N	number(5)	Copy from opcnodes, add 0x0040 Uses IPV6 (also on opc_nodes).
ip_flags	N	int2	This field contains the IP settings flag that determines whether a node is static or DHCP-derived. Possible values are: 0...None 1...Obsolete 2...Static - static IP 16...From agent 32...From server - set on server (default) 256...Alt address (Alternate address. For more information, see Table 29 .) 512...Alt name (Alternate name. For more information, see Table 30 .) 64...IPv6

The actual value in the table is the sum of the values of the desired flags, for example:

- A value of 32 represents a DHCP node (32 for IP set on server).
- A value of 34 represents a static, non-DHCP node (32 for IP set on server plus 2 for static IP).

opc_node_pattern Table

This table contains patterns of nodes for external events.

Table 38: opc_node_pattern Table

Column Name	Constraint	Column Type	Description
pattern_id	N, P	varchar2(36)	Key field for node pattern identification; linked to node_id in opc_nodes (see Table 41).
node_type	N, U	number(5)	Node pattern type. Possible values are: 253...IP address pattern 254...Node name pattern for IP nodes 255...Node name pattern for non IP nodes
pattern	U	varchar2(2048)	Node pattern.
ip_flags		number(5)	IP settings flag to hold static / DHCP defaults.

opc_nodehier_layout Table

This table contains the layout of the node hierarchies. It contains layout elements for both nodes and layout groups.

Table 39: opc_nodehier_layout Table

Column Name	Constraint	Column Type	Description
layout_id	N, P	varchar2(36)	Key field to identify the layout element.
nodehier_id	N, F, U	varchar2(36)	Key field to identify the node hierarchy.
parent_id	F, U	varchar2(36)	Key field to identify the parent layout group. If the parent_id is null, this layout element is in the top level layout group.
symbol_type_id		varchar2(36)	Key field to identify the symbol type string in opc_symbols if the layout element is a layout group.
node_id	F, U	varchar2(36)	Key field used to identify the node. If null, this is a layout group.
name	U	varchar2(254)	Name of the layout element, if it is a layout group.

opc_nodehier_layout Table, continued

Column Name	Constraint	Column Type	Description
label		varchar2(508)	Label displayed in the Java GUI or the Administration UI, if this is a layout group.
submap_title		varchar2(160)	Title of layout group's submap.
description		varchar2(508)	Description of the layout element.

opc_nodehiers Table

This table contains the node hierarchies and their specifications.

Table 40: opc_nodehiers Table

Column Name	Constraint	Column Type	Description
nodehier_id	N, P	varchar2(36)	Key field to identify the node hierarchy.
symbol_type_id	N, F	varchar2(36)	Key field to identify the symbol type string in opc_symbols.
new_obj_layout_id	F	varchar2(36)	Key field to identify the new object holding area layout group (null, if toplevel).
name	N, U	varchar2(254)	Node hierarchy name.
label		varchar2(508)	Node hierarchy label.
description		varchar2(508)	Description of the node hierarchy.
info		varchar2(4000)	Text box for entering additional details about the new node hierarchy.

opc_nodes Table

This table contains details of the nodes in the Node Bank for both external and normal nodes.

Table 41: opc_nodes Table

Column Name	Constraint	Column Type	Description
node_id	N, P	varchar2(36)	Key field to identify the node.

opc_nodes Table, continued

Column Name	Constraint	Column Type	Description
symbol_type_id	N	varchar2(36)	Key field to identify symbol type strings (in opc_symbols).
agent_id	N	varchar2(36)	Reserved for future use.
machine_type	N	number(5)	Type of machine hardware and operating system.
terminal	N	number(3)	Type of terminal connection used to access the node. Possible values are: 0...hpterm 1...xterm 2...dtterm 3...None
maximum_size	N	number(12)	Limit in KBytes the logging information may occupy.
node_type	N	number(3)	Role of node within HPOM. Possible values are: 1...Disabled 2...Controlled 3...Monitored 4...Message-allowed
unmanaged_flag	N	number(3)	Node is currently disabled: Yes/No.
auto_sw_inst_flag	N	number(3)	Distribute HPOM software automatically: Yes/No.
auto_res_mod_flag	N	number(3)	Automatically update system resource files: Yes/No.

opc_nodes Table, continued

Column Name	Constraint	Column Type	Description
sw_dist_req_flag	N	number(3)	HPOM software status on the node. Possible values are: 0...No distribution required 1...Distribution required (no software installed yet) 2...Distributing 4...Required (with Force Update) 5...Distributing (with Force Update) 6...Distribution required (old software is installed) 7...Distribution required (old software is installed; with Force Update) 8...Distributing (old software is installed) 9...Distributing (old software is installed; with Force Update) 10...Deinstalling software
label		varchar2(508)	Name displayed as a label in the Java GUI or the Administration UI.
console_path		varchar2(508)	Program call to establish a connection to physical console port.
logging_directory		varchar2(508)	Path to the directory where HPOM stores local logging information.

opc_nodes Table, continued

Column Name	Constraint	Column Type	Description
node_char_set	N	number(3)	Character set used for the node. Possible values are: 0...ASCII 1...ISO88591 2...ROMAN8 4...ACP1252 (Windows ANSI code page for Western Europe (Latin)) 28...ISO885915 64...SJIS (Japanese SJIS) 65...EUCJP (Japanese EUC) 66...ACP932 (Windows ANSI code page for Japan)
default_font		varchar2(264)	Font used for virtual terminals and input/output applications started on the node.
ncs_pckg_size	N	number(12)	The NCS RPC package size used for communication with the node (obsolete with HPOM 9.xx).
ncs_delay	N	number(3)	Delay between NCS RPC calls (obsolete with HPOM 9.xx).
heartbeat_retry	N	number(3)	Retry of failed heartbeat polls.
mpe_job_stream		varchar2(160)	Name of the used MPE Job Stream Facility.
console_par1		varchar2(80)	The first physical console parameter.
console_par2		varchar2(80)	The second physical console parameter.
console_par3		varchar2(80)	The third physical console parameter.

opc_nodes Table, continued

Column Name	Constraint	Column Type	Description
license_type	N	number(5)	The managed node license counted on the manager (backup server). A license is used when software is installed. If the node license is counted on another manager, it can be reset.
resolve_mode	N	number(3)	IP address resolution mode. Possible values: 0...Auto 1...Static
message_if_enable	N	number(3)	Output to Message Stream Interface enabled: Yes/No.
msg_if_allow_aa	N	number(3)	Allow definition of automatic actions through Message Stream Interface: Yes/No.
msg_if_allow_oa	N	number(3)	Allow definition of operator-initiated actions through Message Stream Interface: Yes/No.
depot_node_id	N	varchar2(36)	Node where an agent package is stored: management server by default.
inst_method	N	number(3)	The installation method. Possible values: 0...HPOM installation (use HPOM install methods) 1...SD installation (use SD for installation) 2...HPOM installation (asynchronous) (use HPOM install methods with asynchronous install) 3...SD installation (asynchronous) (use SD for installation with asynchronous install)

opc_nodes Table, continued

Column Name	Constraint	Column Type	Description
depot_access_meth	N	number(3)	Access method for satellite depots. Possible values: 1...FTP 2...SD 3...RCP 4...SSH
package_name		varchar2(508)	Name of the package for satellite depots. (Not currently used.)
depot_name		varchar2(508)	Contains the source or target directory for the agent depot depending on opc_net_machine.satellite_depot and opc_nodes.inst_method.
compr_pkg_trans	N	number(3)	Use SD's compressed package transfer: Yes/No.
compr_pkg	N	number(3)	Use compressed package for SD installation. (Not currently used.)
inst_user		varchar2(128)	Installation user. Can be modified by the HPOM administrator by using the Java GUI or the Administration UI.

opc_nodes Table, continued

Column Name	Constraint	Column Type	Description
comm_type	N	number(3)	Communication method. Possible values are: 0...Unspecified communication type 1...NCS* 2...DCE TCP* 3...DCE UDP* 4...Sun RPC, TCP* 5...SUN RPC, UDP* 6...TCP Socket* 7...UDP Socket* 8...OPC Interface* 9...RPC Local* 10...HTTPS * Obsolete with HPOM 9.xx.
port_range		varchar2(160)	Port range for DCE on managed node. (The DCE agent is obsolete with HPOM 9.xx.)
proxy_name		varchar2(2048)	Logical name of the proxy node if the attribute is_proxy is set; otherwise the logical name of the proxy node that is used to manage the node if is_proxy is not set and the node is proxied.

opc_nodes Table, continued

Column Name	Constraint	Column Type	Description
comm_attr	N	number(12)	Communication attributes (DCE* security level). Possible values: 0...None 1...Auth. connect 2...Auth. call 3...Auth. pkt. 4...Pkt. Integer 5...Pkt. crypt * The DCE agent is obsolete with HPOM 9.xx.
agent_version	N	number(12)	Control agent RPC interface version.
heartbeat_flag	N	number(3)	Switches heartbeat polling on or off. Possible values are: 1...Heartbeat polling on 0...Heartbeat polling off
heartbeat_type	N	number(3)	Used heartbeat polling method. Possible values are: 0...None 1...RPC only 2...Ping only 3...Ping + RPC 4...From agent 5...From agent + RPC 6...From agent + Ping 7...From agent + RPC + Ping
heartbeat_interval		varchar2(32)	Time interval between heartbeat polls. Format: 1h20m10s.

opc_nodes Table, continued

Column Name	Constraint	Column Type	Description
security_type	N	number(3)	Used security type for Network Security Protocol. For HP Advanced Security only. Possible values are: 0...None 2...Secret key 3...For HP internal use only. 4...GSS_API_V2 128...Interim
security_version	N	number(3)	NSP crypt algorithm version.
agent_type_number	N	number(3)	Number to be used as the default agent type (HPOM is the default).
is_proxy	N	number(3)	Node is a proxy node: Yes/No.
buflim_enable	N	number(3)	Agent buffer size limitation enabled: Yes/No.
buflim_size	N	number(12)	Maximum size of the agent message buffer (in bytes).
buflim_severity	N	number(3)	Minimum severity of the messages to be buffered in case of buffer size conflicts. Possible values are: 0...None 2...Normal 4...Warning 16...Minor 32...Major 8...Critical

opc_nodes Table, continued

Column Name	Constraint	Column Type	Description
ip_flags	N	number(5)	<p>Reserved for future use.</p> <p>This field indicates whether an alternate or an alias IP address or a name are available for the node. The values can be combined by using a logical OR.</p> <p>Possible values are:</p> <p>0x0000...None</p> <p>0x0001...IP obsolete</p> <p>0x0002...Static IP</p> <p>0x0010...IP received by an agent</p> <p>0x0020...IP set on input server</p> <p>0x0100...Alternate IP addresses available</p> <p>0x0200...Alternate IP names available</p>
new_sec_type	N	number(3)	<p>This field is set to the new value as the request is being sent upon changing the security type of a node. When confirmed, the old sec_type field is set to the same value.</p>
certificate_state	N	number(3)	<p>Describes the certificate status.</p> <p>Possible values are:</p> <p>0...Undefined</p> <p>1...Pending</p> <p>2...Granted</p> <p>3...Installed</p>
agt_inst_time	N	number(12)	<p>Time when the agent was installed and started.</p>
agt_inst_dir		varchar2(508)	<p>Location of the agent on the managed node.</p>

opc_nodes Table, continued

Column Name	Constraint	Column Type	Description
cluster_package		varchar2(508)	Name of the package assigned to a virtual node (HARG name).
is_virtual	N	number(3)	If the entry represents a virtual node, this is set to 1.
last_instr_distrib	N	number(12)	The last time an instrumentation distribution took place.
trace_flag	N	number(3)	Agent tracing.
local_last_instr_distrib		date	Reserved for future use.
local_agt_inst_time		date	Reserved for future use.
mac_addrs		varchar2(2048)	List of the MAC addresses of the node.
num_cpus		number(5)	Number of CPUs of the node.
cpu_type		varchar2(508)	Architecture of the CPUs in the node.
os_family		varchar2(508)	Family of the OS installed on the node (Windows, Unix, and so on).
os_type		varchar2(508)	Type of the OS running on the node.
os_name		varchar2(508)	Name of the OS running on the node.
os_vendor		varchar2(508)	Vendor of the OS running on the node.
os_version		varchar2(508)	Version of the OS running on the node.
os_bits		number(3)	Indicates whether the OS is a 32 or 64-bit version.
agent_bits		number(3)	Indicates whether the agent is a 32 or 64-bit version.
status1		number(12)	Reserved for future use.
local_status1		date	Reserved for future use.

opc_nodes Table, continued

Column Name	Constraint	Column Type	Description
status2		number(12)	Reserved for future use.
local_status2		date	Reserved for future use.
status3		number(12)	Reserved for future use.
local_status3		date	Reserved for future use.
status4		number(12)	Reserved for future use.
local_status4		date	Reserved for future use.
status5		number(12)	Reserved for future use.
local_status5		date	Reserved for future use.
info		varchar2(4000)	Field for the operator's notes, for example, for tracking the changes.

opc_nodes_in_group Table

This table represents the relationships of nodes in node groups. It contains entries for all nodes in all node groups.

Table 42: opc_nodes_in_group Table

Column Name	Constraint	Column Type	Description
node_group_id	N, P, F	varchar2(36)	Key field to identify the node group.
node_id	N, P, F	varchar2(36)	Key field to identify the node.

opc_platform_dictionary Table

This table stores the mappings between platform and the instrumentation directory layout identifiers.

Table 43: opc_platform_dictionary Table

Column Name	Constraint	Column Type	Description
type		varchar2(36)	Used to distinguish mappings for the different identifiers.

opc_platform_dictionary Table, continued

Column Name	Constraint	Column Type	Description
instrum_value	N, P	varchar2(1024)	Instrumentation directory layout value.
assd_value	N, P	varchar2(1024)	Platform-dependent value delivered from agent by ASSD (Agent Side System Discovery).
os_type		varchar2(1024)	Operating system type (for example, HP-UX).
cpu_type	N, P	varchar2(1024)	Central processing unit type (for example, Intel).

opc_pltfrm_family Table

This table stores the information for a platform family.

Table 44: opc_pltfrm_family Table

Column Name	Constraint	Column Type	Description
pltfrm_family_name	N, P	varchar2(64)	Unique name for a platform family. Possible values are: <ul style="list-style-type: none"> • MPE • MS • NetWare • OS/2 (For HP internal use only.) • UNIX
user_name_length	N	number(3)	Length of the user name.
password_length	N	number(3)	Length of the password.

opc_policy_cat Table

This table stores the information on links between policies and categories.

Table 45: opc_policy_cat Table

Column Name	Constraint	Column Type	Description
template_id	N, P, F	varchar2(36)	Key field to identify the policy.
category_id	N, P, F	varchar2(36)	Key field to identify the category.

opc_tmplgrp_cat Table

Note: [Table 46](#) is reserved for future use.

This table stores the information on links between policy groups and categories.

Table 46: opc_tmplgrp_cat Table

Column Name	Constraint	Column Type	Description
templ_group_id	N, P, F	varchar2(36)	Key field to identify the policy group.
category_id	N, P, F	varchar2(36)	Key field to identify the category.

Chapter 5: Policy Tables

In This Chapter

This chapter contains the policy tables.

The policies are defined by several tables, among which the main table is described in "[opc_source_templ Table](#)" on the next page. This table contains the `template_id` that is used to identify the corresponding entries in other tables. Depending on the message source type specified in this table, additional tables are used to complete the policy.

opc_node_config Table

Policies can be assigned directly to a node, or indirectly by using policy groups. Also, policies and policy groups can be assigned to node groups. This table contains all resolved policy to node assignments, which helps you to avoid multiple distribution of the same policy.

Table 47: opc_node_config Table

Column Name	Constraint	Column Type	Description
node_id	U, F	varchar2(36)	Key field used to identify the node. If an ECS policy is assigned to the management server, this field is null.
template_id	N, F, U	varchar2(36)	Key field to specify the policy that is assigned to the node.
container_id	U	varchar2(36)	Identifies a container.
status_flag	N	number(3)	Distribution of this configuration. Possible values: 0...No distribution required 1...Distribution required 2...Distributing

opc_node_config Table, continued

Column Name	Constraint	Column Type	Description
access_count	N	number(12)	The number of times that this node-policy assignment occurs. If a new assignment results in the same node-policy assignment, the access_count is increased, and the distribution status is unchanged. If an assignment is removed, the access_count is decreased. If the access_count reaches zero, the entry in opc_node_config is deleted.
cluster_package	U	varchar2(508)	Name of the package assigned to a virtual node (HARG name).

opc_source_tmpl Table

This table contains the fields common to all policy types. The combination of source_type_id and template_name is unique.

Table 48: opc_source_tmpl Table

Column Name	Constraint	Column Type	Description
template_id	N, P	varchar2(36)	Key field to identify the policy.
container_id		varchar2(36)	Identifies the container to which this policy belongs.
pol_type_id		varchar2(36)	Identifies the type of the policy.

opc_source_tmpl Table, continued

Column Name	Constraint	Column Type	Description
source_type_id	N, F, U	number(12)	Type of the policy. Possible values: 1...Console 2...Interface 4...Logfile 8...Monitor 16...SNMP 32...ECS 256...Schedule
modified	N	number(3)	Indicates whether the policy was modified and must be redistributed: Yes/No.
template_name	U	varchar2(508)	Name of the policy.
template_descr		varchar2(508)	Description of the policy.
templ_file_name		varchar2(28)	Name of the distribution file (used to distribute changes only).
lock_user_id		varchar2(36)	Identifies the user who is locking this policy.
templ_version	U	varchar2(64)	Version of the policy.
plugin_id		varchar2(508)	Identify the package to which the policy belongs.
plugin_name		varchar2(2048)	
plugin_descript		varchar2(4000)	
autopass_id		number(12)	Describes the policy license string.
policy_hdr_chksum		varchar2(2048)	Contains the checksum of the policy header.
info		varchar2(4000)	Field for the operator's notes, for example, for tracking the changes.
syntax_version		number(3)	Syntax version of the policy.

opc_tmpl_groups Table

This table contains all configured HPOM policy groups.

Table 49: opc_tmpl_groups Table

Column Name	Constraint	Column Type	Description
templ_group_id	N, P	varchar2(36)	Key field to identify the policy group.
parent_id	N, U	varchar2(36)s	Key field to identify the parent policy group. If the parent_id is null, this policy group is on the top level.
lock_user_id	N	varchar2(36)	Identifies the user who is locking this policy.
templ_group_name	N, U	varchar2(508)	Name of the policy group.
description		varchar2(508)	Description of the policy group.
info		varchar2(4000)	Field for the operator's notes, for example, for tracking the changes.

opc_tmpl_in_tgrp Table

This table contains the policies that are assigned to a policy group.

Table 50: opc_tmpl_in_tgrp Table

Column Name	Constraint	Column Type	Description
templ_group_id	N, P, F, U	varchar2(36)	Key field to identify the policy group.
template_id	N, P, F	varchar2(36)	Key field to identify the assigned policies.
container_id	U	varchar2(36)	Identifies a container.
latest		number(3)	Assignment mode of the policy. Possible values are: 0 - Fixed 1 - Update minor version (1.1->1.2) 2 - Update any (higher) version (1.1->2.0)

opc_tmpl_on_ngrp Table

This table contains the policy-to-node group assignments.

Table 51: opc_tmpl_on_ngrp Table

Column Name	Constraint	Column Type	Description
node_group_id	N, P, F, U	varchar2(36)	Key field to identify the node group.
template_id	N, P, F	varchar2(36)	Key field to identify the assigned policies.
container_id	U	varchar2(36)	Identifies a container.
assign_state		number(3)	Reserved for future use. Indicates whether a policy is assigned to a node group, or not. Possible values are: 0...Deassigned 1...Assigned (default)
assign_exception		number(3)	Reserved for future use. Indicates any exceptions to the assignments listed above. Possible values are: 0...No exception (default) 1...Exception
latest		number(3)	Assignment mode of the policy. Possible values are: 0...Fixed 1...Update minor version (1.1->1.2) 2...Update any (higher) version (1.1->2.0)

opc_tmpl_options Table

This table contains the local logging options and defaults for the message source policies. The event correlation and scheduled action policies do not have entries in this table.

Table 52: opc_tmpl_options Table

Column Name	Constraint	Column Type	Description
template_id	N, P	varchar2(36)	Key field to identify the policy.
log_matched_flag	N	number(3)	Locally log messages matched by a message condition: Yes/No.
log_suppress_flag	N	number(3)	Locally log messages matched by a suppress condition: Yes/No.
log_unmatched_flag	N	number(3)	Locally log messages not matched: Yes/No.
forw_unmatch_flag	N	number(3)	Forward unmatched messages to the management server: Yes/No.
log_only_flag	N	number(3)	Forward unmatched messages to the management server as log-only messages: Yes/No.
def_mpi_output	N	number(3)	Policy default for output to the Message Stream Interface on the management server. Possible values are: 0...No 1...Divert 2...Copy
def_imm_auto_action	N	number(3)	Policy default for starting local automatic actions although Message Stream Interface is enabled: Yes/No.

opc_tmpl_options Table, continued

Column Name	Constraint	Column Type	Description
def_mpi_output_agt	N	number(3)	Policy default for output to the Message Stream Interface on the agent. Possible values are: 0...No 1...Divert 2...Copy
instruction_type	N	number(3)	Policy default for the type of instruction. Possible values: 0 ...No instruction (no instructions at all) 1 ...Instruction text (use instruction text from the opc_instructions table) 2 ...Instruction interface (use instruction text interface)
instruction_id	N	varchar2(36)	Policy default for instruction/instruction text interface ID.
instr_parameters		varchar2(508)	Policy default for the parameters for instruction text interface.
def_service_name		varchar2(4000)	Policy default for service name attribute.
def_msg_key		varchar2(4000)	Policy default for message key attribute.

opc_tmpl_status Table

Note: [Table 53](#) is reserved for future use.

This table contains the distribution and the activation status of the policies on the managed nodes.

Table 53: opc_tmpl_status Table

Column Name	Constraint	Column Type	Description
node_id	N, U	varchar2(36)	Node hosting the policy. Foreign key to opc_nodes.
template_id	N, U	varchar2(36)	Policy assigned to the node. Foreign key to opc_source_tmpl.
template_name	N	varchar2(128)	Policy name. Foreign key to opc_source_tmpl.
templ_version		varchar2(32)	Policy version.
source_type_id	N	number(12)	Policy type. Foreign key to opc_source_tmpl.
templ_status	N	number(5)	Flag word describing the execution status of the policy. Possible values are: 0...Undefined. 1...Assigned but not distributed. 2...Distributed. Unknown status. 3...Distributed. Disabled. 4...Distributed. Enabled.
templ_status_reason	N	varchar2(508)	Text describing the reason for the current status.
status_upd_tstamp	N	number(12)	Time stamp of the latest update of the templ_status field.
local_upd_tstamp	N	date	Time stamp of the latest update of the templ_status field, but as a database date field.

opc_tmpl_on_node Table

This table contains the direct policy-to-node assignments. See [Table 47](#) for information about resolved assignments.

Table 54: opc_tmpl_on_node Table

Column Name	Constraint	Column Type	Description
node_id	U, F	varchar2(36)	Key field to identify the node. If an ECS policy is assigned to the management server, the node_id is null.
template_id	N, F	varchar2(36)	Key field to identify the assigned policy.
container_id	U	varchar2(36)	Identifies a container.
assign_state		number(3)	Reserved for future use. Indicates whether a policy is assigned to a node. Possible values are: 0...Deassigned 1...Assigned (default)
assign_exception		number(3)	Reserved for future use. Indicates any exceptions to the assignments listed above. Possible values are: 0...No exception (default) 1...Exception
latest		number(3)	Assignment mode of the policy. Possible values are: 0...Fixed 1...Update minor version (1.1->1.2) 2...Update any (higher) version (1.1->2.0)

opc_tgrp_in_tgrp Table

This table contains the policy groups that are assigned to a policy group.

Table 55: opc_tgrp_in_tgrp Table

Column Name	Constraint	Column Type	Description
templ_group_id	N, P, F	varchar2(36)	Key field to identify the policy group.
member_grp_id	N, P, F	varchar2(36)	Key field to identify the assigned policy group.

opc_tgrp_on_ngrp Table

This table contains the policy-group-to-node group assignments.

Table 56: opc_tgrp_on_ngrp Table

Column Name	Constraint	Column Type	Description
node_group_id	N, P, F	varchar2(36)	Key field to identify the node group.
templ_group_id	N, P, F	varchar2(36)	Key field to identify the assigned policy group.
assign_state		number(3)	Reserved for future use. Indicates whether a policy group is assigned to a node group. Possible values are: 0...Deassigned 1...Assigned (default)
assign_exception		number(3)	Reserved for future use. Indicates any exceptions to the assignments listed above. Possible values are: 0...No exception (default) 1...Exception
assign_nonhier		number(3)	Flag set to 1 to indicate an assignment without hierarchy.

opc_tgrp_on_node Table

This table contains the policy-group-to-node assignments.

Table 57: opc_tgrp_on_node Table

Column Name	Constraint	Column Type	Description
node_id	U, F	varchar2(36)	Key field to identify the node. If a policy group is assigned to the management server, the node_id is null.
templ_group_id	N, U, F	varchar2(36)	Key field to identify the assigned policy group.
assign_state		number(3)	Reserved for future use. Indicates whether a policy group is assigned to a node. Possible values are: 0...Deassigned 1...Assigned (default)
assign_exception		number(3)	Reserved for future use. Indicates any exceptions to the assignments listed above. Possible values are: 0...No exception (default) 1...Exception
assign_nonhier		number(3)	Flag set to 1 to indicate an assignment without hierarchy.

Chapter 6: Condition Tables

In This Chapter

This chapter contains the condition tables for message source policies.

A condition consists of several parts, some of which are the same for logfile, opcmsg, MPE/iX console, and SNMP trap policies. Others parts are specific to each policy type and therefore are stored in separate tables.

opc_appresp_id_lst Table

This table contains a list of the Application Response IDs of Message Stream Interface registration conditions.

Table 58: opc_appresp_id_lst Table

Column Name	Constraint	Column Type	Description
condition_id	N, U	varchar2(36)	Key field to associate list entries with a Message Stream Interface registration condition (opc_mpi_reg_conds).
appl_resp_id	U	varchar2(36)	Application response ID of a Message Stream Interface registration condition.

opc_cond Table

This table contains the main entries for conditions of the message source type logfile, opcmsg, and MPE/iX console, as well as for registration conditions and regroup conditions.

Table 59: opc_cond Table

Column Name	Constraint	Column Type	Description
condition_id	N, P	varchar2(36)	Key field to identify the condition.
template_id	N, U	varchar2(36)	Key field to identify the policy. This field is null for regroup and registration conditions.

opc_cond Table, continued

Column Name	Constraint	Column Type	Description
nodelist_id	N	varchar2(36)	Key field to identify the list of nodes that is used to check the node attribute of the incoming message. This refers to the table <code>opc_cond_node_list</code> (see " opc_cond_node_list Table " on the next page).
text_id	N	varchar2(36)	Key field to identify the corresponding text pattern in the table <code>opc_cond_text</code> (see " opc_cond_text Table " on page 101).
case_sens_flag	N	number(3)	Check the message text case sensitively: Yes/No.
order_number	N	number(5)	Number specifying the process and display order of the conditions.
condition_type	N	number(3)	Type of condition. Possible values are: 0...MPI reg condition 1...Match condition 2...Suppress condition 3...Suppress unmatched condition
description	U	varchar2(508)	Text describing the condition. <code>opccfgupId</code> uses this text to identify a condition, therefore it must be unique.
fieldseparator		varchar2(32)	Field separators used for pattern matching.

opc_cond_appl_list Table

This table contains lists of applications used in the conditions.

Table 60: opc_cond_appl_list Table

Column Name	Constraint	Column Type	Description
condition_id	N, U	varchar2(36)	Key field to identify the condition.
application	U	varchar2(508)	Application name in the incoming message.

opc_cond_cust_attr Table

This table contains the custom message attribute computation rules assigned to the respective message conditions. The combination of condition_id and cma_name must be unique.

Table 61: opc_cond_cust_attr Table

Column Name	Constraint	Column Type	Description
condition_id	U, N	varchar2(36)	Key field to identify the condition.
cma_name	U, N	varchar2(508)	Name of the custom message attribute.
cma_value_rule	N	varchar2(2048)	Method used to compute the actual value of a custom message attribute.

opc_cond_mgrp_list Table

This table contains a list of message groups for the conditions.

Table 62: opc_cond_mgrp_list Table

Column Name	Constraint	Column Type	Description
condition_id	N, U	varchar2(36)	Key field to identify the condition.
message_group	U	varchar2(254)	Message group in the incoming message.

opc_cond_node_list Table

This table contains lists of nodes used in the conditions.

Table 63: opc_cond_node_list Table

Column Name	Constraint	Column Type	Description
nodelist_id	N, U	varchar2(36)	Key field to identify the list of nodes.

opc_cond_node_list Table, continued

Column Name	Constraint	Column Type	Description
entry_type	N, U	number(3)	Type of node entry: node_id or node_ parameter. Possible values are: 0...Variable (the node string contains text with pattern-matching) 1...IP node (the node string contains the ID of the node in opc_node_names) 5...non IP Node (the node string contains the ID of the node in opc_node_names)
node_string	U	varchar2(508)	This field contains a variable string or a node_ id (depending on the entry_type field).

opc_cond_obj_list Table

This table contains lists of objects used in the conditions.

Table 64: opc_cond_obj_list Table

Column Name	Constraint	Column Type	Description
condition_id	N, U	varchar2(36)	Key field to identify the condition.
object	U	varchar2(508)	Object name in the incoming message.

opc_cond_oper_list Table

This table contains a list of operator names of Message Stream Interface registration conditions.

Table 65: opc_cond_oper_list Table

Column Name	Constraint	Column Type	Description
condition_id	U, N	varchar2(36)	Key field to associate list entries with a Message Stream Interface registration condition (opc_mpi_reg_conds).
operator	U	varchar2(128)	Operator name for the Message Stream Interface registration condition.

opc_cond_sev_list Table

This table contains lists of severities used in the conditions.

Table 66: opc_cond_sev_list Table

Column Name	Constraint	Column Type	Description
condition_id	N, P	varchar2(36)	Key field to identify the condition.
severity	N, P	number(3)	Severity in the incoming message.

opc_cond_stat_var Table

This table holds the values of condition status variables for scheduled outages.

Table 67: opc_cond_stat_var Table

Column Name	Constraint	Column Type	Description
name	N, P	varchar2(2048)	Name and key of a condition status variable.
current_value	N	number(3)	Value of a condition status variable: Yes/No.
default_value	N	number(3)	Default value of a condition status variable: Yes/No.

opc_cond_text Table

This table contains the text patterns of conditions in policies, as well as the message text to set if the condition matches. The text is split into parts of 4000 characters and assembled in the order determined by order_number.

Table 68: opc_cond_text Table

Column Name	Constraint	Column Type	Description
text_id	N, U	varchar2(36)	Key field to identify the text.
order_number	N, U	number(5)	Order number of this text part.
text_part	U	varchar2(4000)	Part of the text.

opc_cond_type_list Table

This table contains a list of message types for a Message Stream Interface registration condition.

Table 69: opc_cond_type_list Table

Column Name	Constraint	Column Type	Description
condition_id	N, U	varchar2(36)	Condition ID from opc_cond_appl_list (see " opc_cond_appl_list Table " on page 98).
message_type	U, P	varchar2(254)	Message type of the registration condition.

opc_mpi_reg_conds Table

This table contains the registration conditions of an active instance of the Message Stream Interface.

Table 70: opc_mpi_reg_conds Table

Column Name	Constraint	Column Type	Description
inst_id	N, P	varchar2(36)	Message Stream Interface instance ID.
condition_nr	N, P	number(12)	Message Stream Interface registration condition number.
condition_id	N, F	varchar2(36)	Condition ID (for condition handling).
event_mask	N	number(12)	Event mask message change events. Possible values (which may be combined with a logical OR) are: 1...Acknowledge 2...Unacknowledge 4...Own 8...Disown 16...Message now has annotations 32...Last annotation deleted 64...Escalated to another server 128...Escalated from another server

opc_mpi_reg_conds Table, continued

Column Name	Constraint	Column Type	Description
			256...Automatic action started 512...Automatic action finished 1024...Operator action started 2048...Operator action finished 4096...Highlight 8192...Buffer 16384...Unbuffer 32768...Modify message 65535...All events
msg_characterist	N	number(12)	Message characteristic of registration condition.

opc_msg_key_rel Table

This table contains the details of relationships between message keys and matching conditions.

Table 71: opc_msg_key_rel Table

Column Name	Constraint	Column Type	Description
condition_id	N	varchar2(36)	Key to link the message key relations to a message condition.
action	N	number(3)	Action for the relation. Possible values: 0...Increase counter 1...Acknowledge
case_sens_flag	N	number(3)	Check message key case sensitiveness: Yes/No.
fieldseparator		varchar2(32)	Field separator used for pattern matching.
msg_key_pattern		varchar2(4000)	Message key pattern of the relation.

opc_open_mpis Table

This table contains runtime data about the Message Stream Interface instances.

Table 72: opc_open_mpis Table

Column Name	Constraint	Column Type	Description
inst_id	N, P	varchar2(36)	Message Stream Interface instance ID.
type	N	number(12)	Type of Message Stream Interface instance as defined for HPOM interfaces in /opt/OV/include/opcsvapi.h.
mpi_mode	N	number(12)	Mode of Message Stream Interface instance as defined in /opt/OV/include/opcsvapi.h.
max_entries	N	number(12)	Maximum number of entries in queue.
name	U	varchar2(32)	Name of Message Stream Interface instance.

opc_rgr_cond Table

This table specifies the regroup conditions (used for redirection of messages to another message group or another service name).

Table 73: opc_rgr_cond Table

Column Name	Constraint	Column Type	Description
condition_id	N, P	varchar2(36)	Key field to identify the condition.
order_number	N	number(5)	Number specifying the process order of the conditions.
new_message_group		varchar2(254)	New message group attribute of the processed message.
service_name		varchar2(4000)	New service name attribute of the processed message.

opc_snmp_variables Table

This table contains lists of the contents of user-defined SNMP variables. SNMP variables are used for pattern matching instead of the message text used by other message sources.

Table 74: opc_snmp_variables Table

Column Name	Constraint	Column Type	Description
snmp_variables_id	N, P	varchar2(36)	Key field to identify the SNMP variables.
variable_text_id	N, P	varchar2(36)	Key field to identify the text pattern in the opc_cond_text table (see " opc_cond_text Table " on page 101), used for checking the variable.
variable_number	N, P	number(5)	Order number of the variable (according to the \$xx value).

Chapter 7: Message Tables

In This Chapter

Although they have nearly the same attributes, the active and history messages are kept in two different sets of tables because of the following reasons:

- Improved performance when loading active messages.
- Reduced time to insert new active messages.

However, when acknowledging or unacknowledging messages, the messages must be moved between the active and history tables. To reduce the impact this has on the Java GUI, the messages are first marked, then moved in groups of 50 by an asynchronous process.

For performance reasons, the message text and the original message text (which is rarely accessed) are stored in separate text tables.

The actions specified in the conditions may contain parameters that are replaced by the matching algorithm. The matching condition is not reported to the management server. Therefore, the actions along with the processed action call become part of the message itself and are not referenced through the condition ID.

opc_act_cust_attr Table

This table contains the actual custom message attribute pairs attached to the associated message. The combination of message_number and cma_name must be unique.

Table 75: opc_act_cust_attr Table

Column Name	Constraint	Column Type	Description
message_number	U, N, F	varchar2(36)	Key field to identify the associated message.
cma_name	U, N	varchar2(508)	Name of the custom message attribute.
cma_value		varchar2(2048)	The actual value of the custom message attribute.

opc_act_messages Table

This table contains the main entry for messages that are currently in the Message Browser window.

This table can also contain messages that are marked as acknowledged. When acknowledging large numbers of messages, the messages are marked by setting the `ackn_flag` field to one (1...Acknowledged message, not yet moved). The `opcdbmsgmv` process runs on a regular basis to move all marked messages to the history tables.

Table 76: opc_act_messages Table

Column Name	Constraint	Column Type	Description
message_number	N, P	varchar2(36)	Key field to identify the message.
condition_id	N	varchar2(36)	Key field to identify the condition matching the message. (Not used.)
instruction_id		varchar2(36)	Key field to identify the instruction text/instruction text interface.
node_id	N, F	varchar2(36)	Key field to identify the node where the event occurred.
msg_gen_node_id	N	varchar2(36)	Key field to identify the node where the message was generated.
network_type	N	number(5)	Type of network the node resides in. Possible values are: 1...IP 5...Other
log_only_flag	N	number(3)	Message was sent as log-only to the server: Yes/No.
unmatched_flag	N	number(3)	Message did not match any condition: Yes/No.

opc_act_messages Table, continued

Column Name	Constraint	Column Type	Description
msg_source_ type	N	number(12)	Message source type. Possible values: 1...Console 2...Interface 4...Logfile 8...Monitor 16...SNMP 256...Schedule 32...Server Message Stream Interface 64...Agent Message Stream Interface 128...Legacy Link Interface 4096...Internal message 8192...Subproduct message
notification_flag	N	number(3)	Message triggered notification: Yes/No.
trouble_tick_flag	N	number(3)	Message generated trouble ticket: Yes/No.
ackn_after_tt_ flag	N	number(3)	Acknowledge message after generation of the trouble ticket: Yes/No.
msggrp_misc_ flag	N	number(3)	Message belongs to message group Misc: Yes/No. (Assigned message group is not configured in HPOM.) This flag is set when the message is added. It may therefore be wrong if the message group was added or deleted afterwards.

opc_act_messages Table, continued

Column Name	Constraint	Column Type	Description
cma_flag		number(3)	Indicate if a custom message attribute is available for the message. Possible values are: 0...No custom message attribute 2...Custom message attribute available (default)
creation_time	N	number(12)	Date and time the message was created on the managed node (in seconds since 00:00 GMT on 1 Jan 1970).
local_creation_time		date	Creation time on agent in server time zone in date format. This is for reporting purposes.
receiving_time	N	number(12)	Date and time the message was received on the management server, or when it was unbuffered (in seconds since 00:00 GMT on 1 Jan 1970).
local_receiving_time		date	Receiving time on server in date format using the server's time zone. This is for reporting purposes.
severity	N	number(3)	Severity attribute of the message. 1...Unknown 2...Normal 4...Warning 8...Critical 16...Minor 32...Major

opc_act_messages Table, continued

Column Name	Constraint	Column Type	Description
auto_status	N	number(3)	Status of the automatic action. Possible values are: 2...Failed 8...Started 9...Finished 11...Defined 12...No action
auto_node_id	N	varchar2(36)	Key field to identify the node where the automatic action will run.
auto_anno_flag	N	number(3)	Automatic action generates annotation: Yes/No.
auto_ackn_flag	N	number(3)	Automatic action acknowledges message: Yes/No.
op_init_status	N	number(3)	Status of the operator-initiated action. Possible values are: 2...Failed 8...Started 9...Finished 11...Defined 12...No action
op_init_node_id	N	varchar2(36)	Key field to identify the node where the operator initiated action will run.
op_init_anno_flag	N	number(3)	Operator-initiated action generates annotation: Yes/No.
op_init_ackn_flag	N	number(3)	Operator-initiated action acknowledges message: Yes/No.

opc_act_messages Table, continued

Column Name	Constraint	Column Type	Description
msg_source_name		varchar2(508)	Name of the message source (policy name).
application		varchar2(508)	Application attribute of the message.
message_group		varchar2(254)	Message group attribute of the message.
object		varchar2(508)	Object attribute of the message.
notify_services		varchar2(508)	Notification services used by this message.
auto_call		varchar2(4000)	Program call for automatic action.
op_init_call		varchar2(4000)	Program call for operator-initiated action.
message_type		varchar2(254)	Message type attribute for the Message Stream Interface. Used to filter messages in ECS.
escalate_flag	N	number(3)	Message is escalated. Possible values are: 0...Not escalated 1...Escalated to 2...Escalated from
assign_flag	N	number(3)	An operator is working on a message and has owned this message. Possible values are: 0...Not owned 4...Owned

opc_act_messages Table, continued

Column Name	Constraint	Column Type	Description
instruction_type	N	number(3)	Type of instruction. Possible values are: 0...No instruction 1...Instruction text 2...Use instruction text interface 3...Instruction for HPOM internal errors
resolved_instr_par		varchar2(508)	Resolved parameters for instruction text interface.
service_name		varchar2(4000)	Service name attribute.
msg_key		varchar2(4000)	Message key to identify the type of a message.
forward	N	number(3)	Message is forwarded to, or from this management server. Possible values are: 0...Not forwarded 1...Forwarded from another server 2...Forwarded to another server 4...Pending forward to another server 5...Forwarded from another server, pending forward to another server 6...Forwarded to another server, pending reforward to another server 7...Forwarded from another server. pending reforward to another server
readonly	N	number(3)	Message is read-only: Yes/No.
original_msgid	N	varchar2(36)	A message_number on the source manager. Also set if an event generates more than one message.

opc_act_messages Table, continued

Column Name	Constraint	Column Type	Description
buffer_flag	N	number(3)	Message is buffered because it is received outside of service hours: Yes/No.
unbuffer_time		number(12)	Time when message will be unbuffered (at start of service hours). Format: in seconds since 00:00 GMT on 1 Jan 1970. If a message is not buffered, this field is null.
local_unbuffer_time		date	Time at which the message has to be unbuffered (service hour start) in date format using the server's time zone. If a message is not buffered, this field is null.
time_diff	N	number(12)	Difference between GMT and the agent time zone where the message was created.
local_agt_creation_time		date	Creation time on the agent in date format using the agent's time zone. This is for reporting purposes only.
ackn_flag	N	number(3)	Message is acknowledged but not yet moved to the history tables. Possible values are: 0...Active message 1...Acknowledged message, not yet moved
ackn_time		number(12)	Acknowledge time of acknowledged (but not yet moved) message in seconds since 00:00 GMT on 1 Jan 1970. This is for reporting purposes only. If the message is not acknowledged, this field is null.
local_ackn_time		date	Acknowledge time in server time zone in date format (for reporting purposes). If the message is not acknowledged, this field is null.

opc_act_messages Table, continued

Column Name	Constraint	Column Type	Description
ackn_user		varchar2(128)	User who acknowledged the message. If the message is not acknowledged, this field is null. The user OpC in this field indicates that HPOM acknowledged the message.
dupl_count	N	number(12)	Number of duplicates of the message.
last_time_received		number(12)	Date and time the last duplicate of this message is received on the management server (in seconds since 00:00 GMT on 1 Jan 1970). If there are no duplicates, this field is null.
local_last_time_received		date	Date and time the last duplicate of this message is received, in date format using the server's time zone (for reporting purposes). If there are no duplicates, this field is null.
anno_count		number(3)	Number of annotations.

opc_anno_text Table

This table contains the annotation text in `opc_act_messages` (see [Table 76](#)). For sizes greater than 4000, the annotation text is split into chunks of 4000 characters.

Table 77: opc_anno_text Table

Column Name	Constraint	Column Type	Description
anno_text_id	N, P	varchar2(36)	Key field to identify the text.
order_number	N, P	number(5)	Order number of this text part.
text_part	N	varchar2(4000)	Text part.

opc_annotation Table

This table contains the main entry of message annotations for messages in `opc_act_messages` (see [Table 76](#)).

Table 78: opc_annotation Table

Column Name	Constraint	Column Type	Description
message_number	N, P	varchar2(36)	First part of key used to identify the message.
anno_text_id	N, P	varchar2(36)	Second part of key used to identify the annotation text in " opc_anno_text Table " on the previous page.
time	N	number(12)	Creation time of the annotation in seconds since 00:00 GMT on 1 Jan 1970.
local_time		date	Creation time of the annotation in the server time zone in date format (for reporting purposes).
anno_number	N	number(5)	Order number of the annotation.
author		varchar2(128)	Name of the HPOM user who entered the annotation. The author is OpC if HPOM generated the action.

opc_escal_assign_m Table

This table contains the message numbers of the owned messages, and messages that were escalated to or from another management server. This refers to messages in `opc_act_messages` (see [Table 76](#)).

Table 79: opc_escal_assign_m Table

Column Name	Constraint	Column Type	Description
message_number	N, P	varchar2(36)	Key to identify the message.
type	N, P	number(3)	Message type: 1...Escalated to 2...Escalated from 4...Owned
node_id	N	varchar2(36)	ID of the node from/to which the message was escalated. (Null ID for owned messages.)

opc_escal_assign_m Table, continued

Column Name	Constraint	Column Type	Description
op_name		varchar2(128)	Name of the operator who escalated or owned the message.
time	N	number(12)	Time the message was escalated or owned.
local_time		date	Time of escalation or time of own in server time zone in date format. This is for reporting purposes.

opc_forward_msgs Table

This table contains a list of messages that have been forwarded to other management servers. One message can be forwarded to more than one manager.

Table 80: opc_forward_msgs Table

Column Name	Constraint	Column Type	Description
message_number	N, P	varchar2(36)	Key field (part 1), associates entries with a message.
target_manager_id	N, P	varchar2(36)	Key field (part 2), node ID of the target manager.
new_message_number	N	varchar2(36)	New message number on the target manager.

opc_forward_msgs Table, continued

Column Name	Constraint	Column Type	Description
type	N	number(12)	Type of forwarded message. Possible values: 1...Readonly 256...Sender 512...Origin 65536...Failed 131072...To inform 262144...Acknowledge on the local server These values can also be combined. For example: 768 = 256 + 512: This means that the indicated server is both the sending server and the original sender of the message.

opc_hist_anno_text Table

This table contains the annotation text for history messages in `opc_hist_messages` (see "[opc_hist_messages Table](#)" on the next page). For sizes greater than 4000, the annotation text is split into chunks of 4000 characters.

Table 81: opc_hist_anno_text Table

Column Name	Constraint	Column Type	Description
anno_text_id	N, P	varchar2(36)	Key field to identify this text.
order_number	N, P	number(5)	Order number of this part of the text.
text_part		varchar2(4000)	Text part.

opc_hist_annotation Table

This table contains the annotations of a history message in `opc_hist_messages` (see "[opc_hist_messages Table](#)" on the next page). The annotation texts are in `opc_hist_anno_text`.

Table 82: opc_hist_annotation Table

Column Name	Constraint	Column Type	Description
message_number	N, P	varchar2(36)	Key to identify the message.
anno_text_id	N, P	varchar2(36)	ID to identify the annotation text in opc_hist_anno_text.
time	N	number(12)	Creation time of the annotation in seconds since 00:00 GMT on 1 Jan 1970.
local_time		date	Creation time of the annotation in the server time zone in date format. This is for reporting purposes.
anno_number	N	number(5)	Order number of the annotation.
author		varchar2(128)	Name of the HPOM operator who entered the annotation.

opc_hist_cust_attr Table

This table contains the actual custom message attribute pairs attached to the associated history message. The combination of message_number and cma_name must be unique.

Table 83: opc_hist_cust_attr Table

Column Name	Constraint	Column Type	Description
message_number	U, N, F	varchar2(36)	Key field to identify the associated message.
cma_name	U, N	varchar2(508)	The name of the custom message attribute.
cma_value		varchar2(2048)	The actual value of the custom message attribute.

opc_hist_messages Table

This table contains the main entry for history messages (that are, the messages that were acknowledged or are log-only). Some acknowledged messages may still be in opc_act_messages (see "[opc_act_messages Table](#)" on page 107).

Table 84: opc_hist_messages Table

Column Name	Constraint	Column Type	Description
message_number	N, P	varchar2(36)	Key field to identify the message.
condition_id	N	varchar2(36)	Key field to identify the condition matching the message. (Not used or set.)
instruction_id		varchar2(36)	Key field to identify the instruction text or instruction text interface.
node_id	N, F	varchar2(36)	Key field to identify the node where the event occurred.
msg_gen_node_id	N	varchar2(36)	Key field to identify the node where the message was generated.
network_type	N	number(5)	Type of network the node resides in. Possible values: 1...IP 5...Other
log_only_flag	N	number(3)	Message was sent as log-only to the management server: Yes/No.
unmatched_flag	N	number(3)	Message did not match any condition: Yes/No.

opc_hist_messages Table, continued

Column Name	Constraint	Column Type	Description
msg_source_ type	N	number(12)	Message source type. Possible values: 1...Console 2...Interface 4...Logfile 8...Monitor 16...SNMP 256...Schedule 32...Server Message Stream Interface 64...Agent Message Stream Interface 128...Legacy Link Interface 4096...Internal message 8192...Subproduct message
notification_flag	N	number(3)	Message triggered notification: Yes/No.
trouble_tick_flag	N	number(3)	Message generated trouble ticket: Yes/No.
ackn_after_tt_ flag	N	number(3)	Acknowledge message after generation of the trouble ticket: Yes/No.
msggrp_misc_ flag	N	number(3)	Message is assigned to Misc: Yes/No.
cma_flag		number(3)	Indicate if a custom message attribute is available for the message. Possible values: 0...No custom message attribute 2...Custom message attribute available (default)

opc_hist_messages Table, continued

Column Name	Constraint	Column Type	Description
creation_time	N	number(12)	Date and time the message was created on the managed node in seconds since 00:00 GMT on 1 Jan 1970.
local_creation_time		date	Creation time on agent in server time zone in date format (for reporting purposes).
local_agt_creation_time		date	Creation time on agent in agent time zone in date format for reporting.
receiving_time	N	number(12)	Date and time the message was received on the management server.
local_receiving_time		date	Time the server received the message in date format using the server's time zone. This is for reporting purposes.
severity	N	number(3)	Severity attribute of the message. 1...Unknown 2...Normal 4...Warning 8...Critical 16...Minor 32...Major
auto_status	N	number(3)	Status of the automatic action. Possible values: 2...Failed 8...Started 9...Finished 11...Defined 12...No action

opc_hist_messages Table, continued

Column Name	Constraint	Column Type	Description
auto_node_id	N	varchar2(36)	Key field to identify the node where the automatic action will run.
auto_anno_flag	N	number(3)	Automatic action generates annotation: Yes/No.
auto_ackn_flag	N	number(3)	Automatic action acknowledges message: Yes/No.
op_init_status	N	number(3)	Status of the operator-initiated action. Possible values: 2...Failed 8...Started 9...Finished 11...Defined 12...No action
op_init_node_id	N	varchar2(36)	Key field to identify the node where the operator initiated action will run.
op_init_anno_flag	N	number(3)	Operator-initiated action generates an annotation: Yes/No.
op_init_ackn_flag	N	number(3)	Operator-initiated action acknowledges the message: Yes/No.
ackn_time	N	number(12)	Date and time the message was acknowledged in seconds since 00:00 GMT on 1 Jan 1970.
local_ackn_time		date	Acknowledge time in server time zone in date format. This is for reporting purposes.
application		varchar2(508)	Application attribute of the message.
auto_call		varchar2(4000)	Program call for automatic action.
op_init_call		varchar2(4000)	Program call for operator-initiated action.

opc_hist_messages Table, continued

Column Name	Constraint	Column Type	Description
ackn_user		varchar2(128)	Operator name who acknowledged the message (OpC if acknowledged by HPOM).
msg_source_name		varchar2(508)	Name of the message source (policy name).
message_group		varchar2(254)	Message group attribute of the message.
object		varchar2(508)	Object attribute of the message.
notify_services		varchar2(508)	Notification services used by this message.
message_type		varchar2(254)	Message type attribute for the Message Stream Interface.
escalate_flag	N	number(3)	Message is escalated. Possible values: 0...Not escalated 1...Escalated to 2...Escalated from
assign_flag	N	number(3)	An operator is working on a message and has owned this message. Possible values: 0...Not owned 4...Owned
instruction_type	N	number(3)	Type of instruction. Possible values: 0...No instruction 1...Instruction text 2...Use instruction text interface 3...Instruction for HPOM internal error

opc_hist_messages Table, continued

Column Name	Constraint	Column Type	Description
resolved_instr_ par		varchar2(508)	Resolved parameters for instruction text interface.
service_name		varchar2(4000)	Service name attribute.
msg_key		varchar2(4000)	Message key to identify a type of the message.
forward	N	number(3)	Message is forwarded to or from this management server. Possible values are: 0...Not forwarded 1...Forwarded from another server 2...Forwarded to another server 4...Pending forward to another server 5...Forwarded from another server, pending forward to another server 6...Forwarded to another server, pending reforward to another server 7...Forwarded from another server. pending reforward to another server
readonly	N	number(3)	Message is read-only: Yes/No.
original_msgid	N	varchar2(36)	message_number on source manager. Also set if an event generates more than one message.
time_diff	N	number(12)	Difference to GMT of the agent time zone when the message was created.
dupl_count	N	number(12)	Number of duplicates of this message.

opc_hist_messages Table, continued

Column Name	Constraint	Column Type	Description
last_time_received		number(12)	Date and time the last duplicate message of this message was received on the management server (in seconds since 00:00 GMT on 1 Jan 1970). If there aren't any duplicates, this field is null.
local_last_time_received		date	Date and time the last duplicate message of this message was received, in date format using the server's time zone (for reporting purposes). If there aren't any duplicates, this field is null.
unbuffer_time		number(12)	Unbuffer time from the active message table.
local_unbuffer_time		date	Date in local format.
receiving_time	N	number12	Timestamp of reception of the message.
anno_count		number(3)	Number of annotations.

opc_hist_msg_text Table

This table holds the message text (divided in 4000 byte parts) of a history message in `opc_hist_messages` (see "[opc_hist_messages Table](#)" on page 118).

Table 85: opc_hist_msg_text Table

Column Name	Constraint	Column Type	Description
message_number	N, P	varchar2(36)	Part one of key, which is used to identify the message.
order_number	N, P	number(5)	Part two of key, which represents order of the text parts.
text_part		varchar2(4000)	4000 byte parts of the message text.

opc_hist_orig_text Table

This table holds the original message text (divided in 4000 byte parts) of a history message in `opc_hist_` messages (see "[opc_hist_messages Table](#)" on page 118).

Table 86: opc_hist_orig_text Table

Column Name	Constraint	Column Type	Description
message_number	N, P	varchar2(36)	Part one of key used to identify the message.
order_number	N, P	number(5)	Part two of key, used for order of the text parts.
text_part		varchar2(4000)	4000 byte parts of the original message text.

opc_instr_intf Table

This table contains the definition of instruction text interfaces.

Table 87: opc_instr_intf Table

Column Name	Constraint	Column Type	Description
name	N, P	varchar2(36)	Key field that contains the name of instruction interface. This name is written in the <code>instruction_id</code> of a condition or message.
description		varchar2(508)	Description of instruction interface.
instr_intf_call		varchar2(4000)	Program call for instruction interface.
node_id	N	varchar2(36)	Node where program call is executed.
start_on_mgmt_sv	N	number(3)	Start instruction interface call on management server.
username		varchar2(128)	OS user of program call.

opc_instr_intf Table, continued

Column Name	Constraint	Column Type	Description
output_mode	N	number(3)	Output in Terminal/No Window Possible values: 0...No window 1...Input/output 2...Output only
resolve_for_ttns	N	number(3)	Resolve external instruction for trouble ticket or notification service: Yes/No.

opc_instructions Table

This table contains the text of normal instructions. For sizes greater than 4000, the text is split into chunks of 4000 characters.

Table 88: opc_instructions Table

Column Name	Constraint	Column Type	Description
instruction_id	N, P	varchar2(36)	Key field to identify the instruction text.
order_number	N, P	number(5)	Order number of this part of the text.
text_part		varchar2(4000)	Text part.

opc_msg_text Table

This table contains the message text for messages in [opc_act_messages Table](#) (see "[opc_act_messages Table](#)" on page 107). For sizes greater than 4000, the text is split into chunks of 4000 characters.

Table 89: opc_msg_text Table

Column Name	Constraint	Column Type	Description
message_number	N, P	varchar2(36)	Part one of key to identify the message.
order_number	N, P	number(5)	Order number of this text part.
text_part		varchar2(4000)	Text part.

opc_orig_msg_text Table

This table contains the original (unprocessed) text of messages in `opc_act_messages` (see "[opc_act_messages Table](#)" on page 107). For sizes greater than 4000, the text is split into chunks of 4000 characters.

Table 90: opc_orig_msg_text Table

Column Name	Constraint	Column Type	Description
message_number	N, P	varchar2(36)	Part one of key to identify the message.
order_number	N, P	number(5)	Order number of this text part.
text_part		varchar2(4000)	Text part.

opc_service_msgs Table

This table supports reports that show all messages related to a service.

Table 91: opc_service_msgs Table

Column Name	Constraint	Column Type	Description
service_name	N, P	varchar2(4000)	Service name that is affected.
msg_service_name	N, P	varchar2(4000)	Service name in the message.

Chapter 8: Other Tables

In This Chapter

This chapter contains the tables that are not classified into any of the previous categories.

opc_change_status Table

This table contains the change flags for the HPOM nodes and users.

Table 92: opc_change_status Table

Column Name	Constraint	Column Type	Description
object_id	N, P	varchar2(36)	Name and key of a condition status variable (linked to node_id or user_id).
object_type	N, P	number(5)	Type of object. Possible values are: 1...Node 2...User
status_type	N, P	number(5)	Status flag type. Possible values are: 1...(node) Node configuration (policy) distribution status. 2...(node) Nodeinfo distribution status. 3...(node) Action script distribution status. 4...(node) Command script distribution status. 5...(node) Monitor script distribution status. 6...(user) Domain (node hierarchy) change flag. 7...(user) Realm (responsibility) change

opc_change_status Table, continued

Column Name	Constraint	Column Type	Description
			flag. 8...(user) Desktop (assigned applications) change flag. 9...(user) OV change application change flag.
value		number(12)	Value of the change flag or the change status. For the user change flags, the value is either 0 or 1. For nodes, possible values are: 0...Active (no distribution necessary) 1...Modified (distribution necessary) 2...Distribute (configuration is currently distributed) 3...Ignore 4...Modified force (distribution enforced) 5...Distribute force (enforced distribution in progress)

opc_cma_names Table

This temporary table contains the names of all available custom message attributes for selection in the Java GUI browser configuration.

Table 93: opc_cma_names Table

Column Name	Constraint	Column Type	Description
cma_name	N	varchar2(508)	Custom message attribute name.

opc_db_maintenance Table

This table contains the database maintenance configuration for the HPOM management server.

Table 94: opc_db_maintenance Table

Column Name	Constraint	Column Type	Description
max_num_active	N, P	number(12)	Maximum number of active messages allowed. (Messages are generated if this value is exceeded.)
max_num_hist	N	number(12)	Maximum number of history messages allowed. (Messages are generated if this value is exceeded.)
send_msg_act_flag	N	number(3)	Send message if limit of active messages is exceeded: Yes/No.
send_msg_hist_flag	N	number(3)	Send message if limit of history messages is exceeded: Yes/No.
download_hist_flag	N	number(3)	Automatically download history messages: Yes/No.
hist_older	N	number(12)	Number of seconds to wait after acknowledgment of a message before downloading it into history tables.
hist_at_time		varchar2(64)	Download the messages at the specified time. Format: 00:00:00
hist_notific_flag	N	number(3)	Generate messages when downloading the history messages: Yes/No.
hist_into_file		varchar2(508)	Download history messages into the specified file.

opc_message_groups Table

This table contains the messages groups of the Message Group Bank.

This table does not contain an ID field for message groups because it may not always be possible to substitute the message group of an object (message, condition, ...) with an ID. The object may contain message group names which are unknown to the database at the time.

Table 95: opc_message_groups Table

Column Name	Constraint	Column Type	Description
name	N, P	varchar2(254)	Key field to identify the message group.
symbol_type_id	N	varchar2(36)	Key field to identify the symbol type string in opc_symbols.
description		varchar2(508)	Description of the message group.
label		varchar2(508)	Label of the message group.
info		varchar2(4000)	Field for the operator's notes, for example, for tracking the changes.

opc_notif_schedule Table

This table represents the schedule for the notification services.

Table 96: opc_notif_schedule Table

Column Name	Constraint	Column Type	Description
notif_svc_id	N	varchar2(36)	Key field to identify the notification service.
day	N	number(3)	Day of the week. Possible values are: 0...Sunday 1...Monday 2...Tuesday 3...Wednesday 4...Thursday 5...Friday 6...Saturday
start_time	N	varchar2(32)	Time when the notification service starts (internal format).
end_time	N	varchar2(32)	Time when the notification service stops (internal format).

opc_notif_services Table

This table represents the configured notification services.

Table 97: opc_notif_services Table

Column Name	Constraint	Column Type	Description
notif_svc_id	N, P	varchar2(36)	Key field to identify the notification service.
notif_svc_name	U	varchar2(64)	Identifies and describes the name of the notification service.
notif_call		varchar2(508)	Program called for this notification service.

opc_service Table

This table contains basic information about services for which service logs are generated. It is used to map services names to service labels, so that reports display the label instead of the name.

Table 98: opc_service Table

Column Name	Constraint	Column Type	Description
service_name	N, P	varchar2(4000)	Key field to identify the service.
label	N	varchar2(508)	Service label displayed in the Java GUI or the Administration UI.
active_log_datetime	N	number(12)	Field to identify the currently active log in the opc_service_log table.
log_service	N	number(3)	Service is still actively logged: Yes/No.
original_id		varchar2(4000)	Original service ID as passed by the service engine.

opc_service_log Table

This table contains the service status logs (severity and duration).

Table 99: opc_service_log Table

Column Name	Constraint	Column Type	Description
service_name	P, F, N	varchar2(4000)	Key field to identify the service.
datetime	P, N	number(12)	Start time of the status log; in seconds since 00:00 GMT on 1 Jan 1970.
local_datetime	N	date	Start time of the status log in date format using the server's time zone. For reporting purposes only.
severity	N	number(3)	Severity attribute of the status log. Possible values are: 1...Unknown 2...Normal 4...Warning 8...Critical 16...Minor 32...Major
end_datetime		number(12)	End time of the status log; in seconds since 00:00 GMT on 1 Jan 1970. If the status log is active, this field is null.
local_end_datetime		date	End time of the status log in date format using the server's time zone. For reporting purposes only. If the status log is active, this field is null.

opc_service_log Table, continued

Column Name	Constraint	Column Type	Description
calculation_name	N, P	varchar(508)	<p>Status calculation name.</p> <p>Possible values for status calculation views are:</p> <ul style="list-style-type: none"> • Overall <p>Overall view displays the latest service status calculation of the day. This view considers both owned messages and messages that have not been assigned to any operator.</p> <ul style="list-style-type: none"> • Operational <p>Operational view displays the service status calculation of all active messages. This view considers only messages that have not been assigned to any operator.</p> <p>Only HPOM administrators can enable and configure these multistate status calculation views on the management server by editing the XPL configuration file.</p>
default_calculation	N	number(3)	<p>Default status calculation.</p> <p>Possible values are:</p> <p>0...Non default calculation.</p> <p>1...Default calculation.</p> <p>Note that you can customize the default value.</p>

opc_symbols Table

This table contains the HP Software Windows symbol names used by HPOM. Other configuration tables do not contain the symbol names but use the symbol_type_id as a reference.

Table 100: opc_symbols Table

Column Name	Constraint	Column Type	Description
symbol_type_id	N, P	varchar2(36)	Key field to identify the symbol type strings.
symbol_name	U	varchar2(160)	String representing the symbol type and shape used in HP Software Windows.

opc_temp_appl_list Table

Table for temporary data for filtering messages based on applications.

Table 101: opc_temp_appl_list Table

Column Name	Constraint	Column Type	Description
name		varchar2(508)	Application name.

opc_temp_msggrp_list Table

Table for temporary data for filtering messages based on message groups.

Table 102: opc_temp_msggrp_list Table

Column Name	Constraint	Column Type	Description
name	N	varchar2(254)	Message group name.

opc_temp_node_list Table

Table for temporary storage of node IDs. Used for filtering of messages based on nodes, for acknowledging messages of a deleted external node and for finding responsible operators.

Table 103: opc_temp_node_list Table

Column Name	Constraint	Column Type	Description
node_id	N	varchar2(36)	Node ID.

opc_temp_object_list Table

Table for temporary data for filtering messages based on objects.

Table 104: opc_temp_object_list Table

Column Name	Constraint	Column Type	Description
name		varchar2(508)	Object name.

opc_temp_service_list Table

Table for temporary data for filtering messages based on services.

Table 105: opc_temp_service_list Table

Column Name	Constraint	Column Type	Description
service_name	N	varchar2(4000)	Service name.

opc_temp_tmpl Table

Table for temporary storage of policy IDs.

Table 106: opc_temp_tmpl Table

Column Name	Constraint	Column Type	Description
template_id	N	varchar2(36)	Policy ID.

opc_tmp_filter_appl Table

Temporary table for improved selection of filtered applications.

Table 107: opc_tmp_filter_appl Table

Column Name	Constraint	Column Type	Description
application	N, P	varchar2(508)	Key field to identify the application.

opc_tmp_filter_cma Table

Temporary table for improved selection of filtered custom message attributes.

Table 108: opc_tmp_filter_cma Table

Column Name	Constraint	Column Type	Description
cma_name	P, N	varchar2(508)	Name of the custom message attribute.
cma_value	P, N	varchar2(2048)	Value of the custom message attribute.

opc_tmp_filter_msggrp Table

Temporary table for improved selection of filtered message groups.

Table 109: opc_tmp_filter_msggrp Table

Column Name	Constraint	Column Type	Description
message_group	N	varchar2(254)	Message group in the incoming message.

opc_tmp_filter_node Table

Temporary table for improved selection of filtered nodes.

Table 110: opc_tmp_filter_node Table

Column Name	Constraint	Column Type	Description
node_name	N	varchar2(2048)	This field contains the name of a node.

opc_tmp_filter_obj Table

Temporary table for improved selection of filtered objects.

Table 111: opc_tmp_filter_obj Table

Column Name	Constraint	Column Type	Description
object	N, P	varchar2(508)	Key field to identify the object.

opc_tmp_filter_pattern_node Table

Temporary table for improved selection of filtered external nodes.

Table 112: opc_tmp_filter_pattern_node Table

Column Name	Constraint	Column Type	Description
node_id	N	varchar2(36)	This field contains the identifier of an external node.

opc_tmp_filter_service Table

Temporary table for improved selection of filtered services.

Table 113: opc_tmp_filter_service Table

Column Name	Constraint	Column Type	Description
service_name	N	varchar2(4000)	Key field to identify the service name in a message.

opc_tmp_misc_msggrp Table

Temporary table for improved selection of the message group Misc.

Table 114: opc_tmp_misc_msggrp Table

Column Name	Constraint	Column Type	Description
message_group	N, P	varchar2(254)	Key field to identify the message group Misc.

opc_tmp_msg_id Table

Temporary table for improved selection of message IDs.

Table 115: opc_tmp_msg_id Table

Column Name	Constraint	Column Type	Description
message_number	N, P	varchar2(36)	Key field to identify the message.

opc_tmp_msg_id_service Table

Temporary table for improved selection of message IDs related to services.

Table 116: opc_tmp_msg_id_service Table

Column Name	Constraint	Column Type	Description
message_number	N, P	varchar2(36)	Key field to identify the message.

opc_tmp_valid_msggrp Table

Temporary table for improved selection of valid message groups.

Table 117: opc_tmp_valid_msggrp Table

Column Name	Constraint	Column Type	Description
message_group	N, P	varchar2(254)	Key field to identify the message group of a message.

opc_tmp_visible_msggrp Table

Temporary table for improved selection of visible message groups.

Table 118: opc_tmp_visible_msggrp Table

Column Name	Constraint	Column Type	Description
message_group	N, P	varchar2(254)	Key field to identify the message group of a message.

opc_tmp_visible_node Table

Temporary table for improved selection of visible nodes.

Table 119: opc_tmp_visible_node Table

Column Name	Constraint	Column Type	Description
node_id	N	varchar2(36)	Key field to identify the node.
node_group_id	N	varchar2(36)	Key field to identify the node group.

opc_tmp_visible_node2 Table

Second temporary table for improved selection of visible nodes.

Table 120: opc_tmp_visible_node2 Table

Column Name	Constraint	Column Type	Description
node_id	N	varchar2(36)	Key field to identify the node.
node_group_id	N	varchar2(36)	Key field to identify the node group.

opc_tmp_visible_pattern Table

Temporary table for improved selection of visible patterns.

Table 121: opc_tmp_visible_pattern Table

Column Name	Constraint	Column Type	Description
node_id	P, N	varchar2(36)	Key field to identify the node.
pattern_id	P, N	varchar2(36)	Key field for node pattern identification; linked to node_id in opc_nodes (" opc_nodes Table " on page 72).

opc_tmp_visible_profile Table

Temporary table for improved selection of visible user profiles.

Table 122: opc_tmp_visible_profile Table

Column Name	Constraint	Column Type	Description
user_id	N, P	varchar2(36)	Key field to identify the user profile.

opc_tmp_visible_service Table

Temporary table for improved selection of visible services.

Table 123: opc_tmp_visible_service Table

Column Name	Constraint	Column Type	Description
service_name	N	varchar2(4000)	Key field to identify the service name in a message.

opc_trouble_ticket Table

This table contains the actual status and program call for forwarding a message to a trouble ticket system.

Table 124: opc_trouble_ticket Table

Column Name	Constraint	Column Type	Description
status_flag	N	number(3)	Trouble ticket interface enabled: Yes/No.
tt_call		varchar2(508)	Program called to forward a message to a trouble-ticket system.

opc_s2s_sync Table

This table is used to establish the last time a particular configuration object was modified.

Table 125: opc_s2s_sync Table

Column Name	Constraint	Column Type	Description
object_id	N	varchar2(36)	Key field to identify the object.
last_chg_time	N	numer(12)	Last time the object was modified.

opc_policy_type Table

This table contains information about policy types.

Table 126: opc_policy_type Table

Column Name	Constraint	Column Type	Description
policy_type_num	N, P	number(12)	References the old way of distinguishing policy types.
policy_type_uuid	N, U	varchar2(36)	ID of the policy type.
policy_type_name	N, U	varchar2(2048)	Server-side name of the policy type.
name_on_agent	N	varchar2(2048)	Agent-side name of the policy type.

opc_policy_type Table, continued

Column Name	Constraint	Column Type	Description
policy_editor		varchar2(4000)	Editor called for the policies of this type.
policy_edit		varchar2(4000)	Call-back commands are defined to be run before deployment of a policy of this type.
policy_check		varchar2(4000)	Call-back commands are defined to be run before upload of a policy of this type to the database.
policy_deploy		varchar2(4000)	Call-back commands are defined to be run during deployment of a policy of this type.
policy_cleanup		varchar2(4000)	Call-back commands are defined to be run after deployment of a policy of this type.
policy_template	N	blob (Oracle) / bytea (PostgreSQL) ()	Policy body template for creation of a policy of this type.
default_content_encoding		varchar2(254)	Default MIME type.
server_and_or_agent		number(3)	Reserved for future use. Specifies whether a policy can be deployed only to the management server or to an agent, or to both.

opc_policy_body Table

This table contains information about policy types.

Table 127: opc_policy_body Table

Column Name	Constraint	Column Type	Description
policy_id	N, F, U	varchar2(36)	Key field that identifies the policy.
policy_body_filename	N, U	varchar2(2048)	Suffix to the name of the file that contains the policy body.

opc_policy_body Table, continued

Column Name	Constraint	Column Type	Description
policy_body	N	blob (Oracle) / bytea (PostgreSQL) ()	Body of the policy.
policy_body_ chksum		varchar2(2048)	Checksum of the policy body.
policy_body_ number		number(3)	Position of this body inside the policy.
policy_body_ encoding		varchar2(1024)	MIME type of the policy body.
content_ encoding		varchar2(254)	Encoding of the content.

opc_policy_attr Table

This table contains a list of attributes of a policy. These are, for example, header checksum, creation date, user, and so on.

Table 128: opc_policy_attr Table

Column Name	Constraint	Column Type	Description
policy_id	N, F, U	varchar2(36)	Id of the policy.
attr_name	N, U	varchar2(4000)	Name of the attribute (for example, checksum_ header, creation_user, or creation_date).
attr_value		varchar2(4000)	Value of the attribute.

opc_op_filter Table

This table assigns a filter to a user.

Table 129: opc_op_filter Table

Column Name	Constraint	Column Type	Description
filter_id	N, F, U	varchar2(36)	Field to identify the filter.
user_id	N, F	varchar2(36)	Field to identify the user.

opc_license_info Table

This table stores information about licenses used by a node.

Table 130: opc_license_info Table

Column Name	Constraint	Column Type	Description
node_id	N, U	varchar2(36)	Identifies the node.
plugin_id	N, U	varchar2(508)	Identification name of the plugin.
num_instances	N	number(12)	Number of instances used.
time_stamp	N	number(12)	Indicates the last time the license was checked.
license_mgr	N	varchar2(4000)	Name of the license manager node.

opc_license_count Table

This table contains the list of the agentless and other types of licenses.

Table 131: opc_license_count Table

Column Name	Constraint	Column Type	Description
plugin_id	N	varchar(508)	Identification name of the plugin.
num_instances	N	number(12)	Number of instances used.
time_stamp	N	number(12)	Indicates the last time the license was checked.

opc_instr_in_policy Table

This table assigns an instruction to a policy.

Table 132: opc_instr_in_policy Table

Column Name	Constraint	Column Type	Description
template_id	N, F, P	varchar2(36)	Key field to identify the policy.
instruction_id	N, P	varchar2(36)	Key field to identify the instruction.

opc_filter Table

Note: [Table 133](#) is reserved for future use.

Table 133: opc_filter Table

Column Name	Constraint	Column Type	Description
filter_id	N, P	varchar2(36)	Reserved for future use.
filter_name	N	varchar2(1024)	Reserved for future use.
filter_data	N	clob (Oracle) / text (PostgreSQL) ()	Reserved for future use.
is_global		number(3)	Reserved for future use.

Chapter 9: Database Views

In This Chapter

This chapter contains the information about the database views.

opc_v_ack_messages View

This view contains a list of users with their count of owned and/or acknowledged messages.

Table 134: opc_v_ack_messages View

Column Name	Column Type	Description
realname	varchar2(128)	The HPOMuser's real name.
name	varchar2(128)	HPOM user or user profile name.
owned	number	Number of owned messages.
acknowledged	number	Number of acknowledged messages.

opc_v_ack_messages_by_date View

This view contains a list of users with their count of owned and/or acknowledged messages sorted by date.

Table 135: opc_v_ack_messages_by_date View

Column Name	Column Type	Description
flag	char(1)	Flagged messages.
realname	varchar2(128)	The HPOM user's real name.
msg_count	number	Number of messages.
name	varchar2(128)	HPOM user or user profile name.
recvd_time	date	Date and time.

opc_v_actions View

This view contains the status of automatic and operator initiated actions. It counts the number as failed, successful, remaining, and total number of actions.

Table 136: opc_v_actions View

Column Name	Column Type	Description
name	char(25)	Action type. Possible types are automatic recovery and operator-initiated actions.
successful	number	Number of successful actions.
failed	number	Number of failed actions.
remaining	number	Number of remaining actions.
total	number	Total number of actions.

opc_v_all_messages View

This view contains a list of all messages, both historical and active.

Table 137: opc_v_all_messages View

Column Name	Column Type	Description
receiving_time	date	Date and time the message was received on the management server, or when it was unbuffered (in seconds since 00:00 GMT on 1 Jan 1970).
application	varchar2(508)	Application attribute of the message.
severity	number(3)	Severity of the message.
message_group	varchar2(254)	Message group attribute of the message.
local_creation_time	date	Creation time on agent in server time zone in date format.

opc_v_all_user_profiles View

This view contains all users and the profiles they are assigned to, directly or indirectly.

Table 138: opc_v_all_user_profiles View

Column Name	Column Type	Description
user_id	varchar2(36)	Field to identify the user.
name	varchar2(128)	HPOM user or user profile name.
realname	varchar2(128)	The HPOM user's real name.
user_role	number(3)	Role of the user: operator, administrator. Possible values: 0...Operator 1...Administrator 3...Policy administrator 4...User profile
result_id	varchar2(36)	Profile id or user id.

opc_all_user_realm View

This view contains a list of the users and their assigned responsibilities.

Table 139: opc_all_user_realm View

Column Name	Column Type	Description
user_id	varchar2(36)	Field to identify the user.
name	varchar2(128)	HPOM user or user profile name.
realname	varchar2(128)	The HPOM user's real name.
user_role	number(3)	Role of the user: operator, administrator. Possible values: 0...Operator 1...Administrator 3...Policy administrator 4...User profile

opc_all_user_realm View, continued

Column Name	Column Type	Description
msg_group_name	varchar2(254)	The message group name.
node_group_id	varchar2(36)	Field to identify the node group.

opc_v_assigned_mess View

This view contains a list of services and the amount of active and historical messages assigned to these services.

Table 140: opc_v_assigned_mess View

Column Name	Column Type	Description
service_name	varchar2(4000)	Service name.
act_count	number	Number of active messages.
hist_count	number	Count of historical messages.

opc_v_mess_serv View

This view contains data about services and the active messages related to these services.

Table 141: opc_v_mess_serv View

Column Name	Column Type	Description
service_name	varchar2(4000)	Service name.
message_number	varchar2(36)	Number of the message.
receiving_time	number(12)	Date and time the message was received on the management server, or when it was unbuffered (in seconds since 00:00 GMT on 1 Jan 1970).
local_receiving_time	date	Receiving time on server in date format using the server's time zone.
local_creation_time	date	Creation time on agent in server time zone in date format.
ackn_flag	number(3)	Number of acknowledge messages.

opc_v_mess_serv View, continued

Column Name	Column Type	Description
buffer_flag	number(3)	Number of messages buffered.
unbuffer_time	number(12)	Unbuffer time of the message.
application	varchar2(508)	Application attribute of the message.
severity	number(3)	Severity of the message.

opc_v_nodegrp_msg View

This view contains local receiving time of active/historical messages and the node group related to these messages.

Table 142: opc_v_nodegrp_msg View

Column Name	Column Type	Description
receiving_time	date	Date and time the message was received on the management server, or when it was unbuffered (in seconds since 00:00 GMT on 1 Jan 1970).
node_group_name	varchar2(2048)	Field to identify the node group.

opc_v_node_count View

This view contains a list of node groups, the number of nodes they contain and the total number of nodes.

Table 143: opc_v_node_count View

Column Name	Column Type	Description
name	varchar2(2048)	Name of the node.
count	number	Number of nodes.
totalcnt	number	Total count of the nodes.

opc_v_node_severities View

This view contains the number of nodes with a particular severity status (the gravest severity in any of their non-acknowledged messages).

Table 144: opc_v_node_severities View

Column Name	Column Type	Description
severity	varchar2(8)	Severity of the message. Possible values are: <ul style="list-style-type: none"> • Unknown • Normal • Warning • Minor • Major • Critical
amount	number	Number of nodes with maximum severity of unacknowledged messages.

opc_v_operator_msg_load View

This view contains a list of users, and a count of messages for each unacknowledged category with dates ranging from first and from last date.

Table 145: opc_v_operator_msg_load View

Column Name	Column Type	Description
realname	varchar2(128)	The HPOM user's real name.
name	varchar2(128)	HPOM user or user profile name.
severity	number(3)	Severity of the messages.
num_messages	number	Number of messages.

opc_v_operator_msg_load View, continued

Column Name	Column Type	Description
min_datetime	date	Minimum date time.
max_datetime	date	Maximum date time.
total_msgs	number	Total number of unacknowledged messages.

opc_v_service View

This view contains the names and labels of HPOM services.

Table 146: opc_v_service View

Column Name	Column Type	Description
service_name	varchar2(4000)	Service name.
label	varchar2(508)	Service label.

opc_v_service_log View

This view contains a subset of fields from the service log table.

Table 147: opc_v_service_log View

Column Name	Column Type	Description
service_name	varchar2(4000)	Service name.
datetime	number(12)	Start time of the status log; in seconds since 00:00 GMT on 1 Jan 1970.
local_datetime	date	Start time of the status log in date format using the server's time zone.
severity	number(3)	Severity of the message.
end_datetime	number(12)	End time of the status log; in seconds since 00:00 GMT on 1 Jan 1970. If the status log is active, this field is null.
local_end_datetime	date	End time of the status log in date format using the server's time zone. If the status log is active, this field is null.

opc_v_service_msg View

This view contains a set of data about services and the active and historical messages related to these services.

Table 148: opc_v_service_msg View

Column Name	Column Type	Description
service_name	varchar2(4000)	Service name.
label	varchar2(508)	Service label.
receiving_time	date	Date and time the message was received on the management server, or when it was unbuffered (in seconds since 00:00 GMT on 1 Jan 1970).
severity	number(3)	Severity of the messages.

opc_v_service_msgs_act View

This view contains a list of services and the active and service messages assigned to these services.

Table 149: opc_v_service_msgs_act View

Column Name	Column Type	Description
service_name	varchar2(4000)	Service name.
label	varchar2(508)	Service label.
receiving_time	date	Date and time the message was received on the management server, or when it was unbuffered (in seconds since 00:00 GMT on 1 Jan 1970).
local_creation_time	date	Creation time on agent in server time zone in date format. This is for reporting purposes.
severity	number(3)	Severity of the message.
ackn_flag	number(3)	Acknowledged message.

opc_v_unassigned_messages View

This view contains a set of data from all messages, active or historical.

Table 150: opc_v_unassigned_messages View

Column Name	Column Type	Description
message_number	varchar(36)	Key filed to identify the message.
message_group	varchar(254)	Message group attribute of the message.
node_id	varchar(36)	Field to identify the node.

opc_v_unassigned_resp View

This view contains a list of couples of message groups and node groups that are not assigned to any operator.

Table 151: opc_v_unassigned_resp View

Column Name	Column Type	Description
mg_name	varchar(254)	The message group name.
ng_name	varchar(2048)	Name of the node group.

Chapter 10: Secondary Indexes

In This Chapter

This chapter contains the secondary indexes.

Secondary Indexes

In addition to the primary keys, HPOM uses the following secondary indexes to improve the performance of queries that are not using primary keys. Using secondary indexes also ensures the uniqueness of entries if this is not possible through the table definitions.

Table 152: Secondary Indexes

Index Name	On Table	Columns
opc_groups_of_node	opc_nodes_in_group	node_id node_group_id
opc_grp_in_realm	opc_op_realm	node_group_id msg_group_name user_id
opc_hist_time	opc_hist_messages	ackn_time
opc_hmessage_msggrp	opc_hist_messages	message_group
opc_hmessage_nodes	opc_hist_messages	node_id
opc_message_msggrp	opc_act_messages	message_group
opc_message_nodes	opc_act_messages	node_id

Secondary Indexes , continued

Index Name	On Table	Columns
opc_node_agent_id	opc_nodes	agent_id node_id
opc_node_full_name	opc_node_names	ip_address node_id network_type node_name
opc_node_ip	opc_node_names	ip_address node_id network_type node_name
opc_node_unique	opc_node_names	ip_address network_type node_name
opc_s2s_sync_index1	opc_s2s_sync	object_id last_chg_time
opc_svclog_1	opc_service_log	service_name calculation_name end_datetime
opc_tmpl_on_node	opc_node_config	template_id node_id status_flag
opc_tmpl_unique	opc_source_tmpl	template_name source_type_id

Secondary Indexes , continued

Index Name	On Table	Columns
opcx_anno_num	opc_annotation	message_number anno_number
opcx_msg_key	opc_act_messages	msg_key
opcx_msg_key_rel	opc_msg_key_rel	condition_id
opcx_nodehier_layout_1	opc_nodehier_layout	node_id nodehier_id
opcx_nodehier_layout_2	opc_nodehier_layout	parent_id

Chapter 11: Foreign Keys

In This Chapter

This chapter contains the foreign keys.

Foreign Keys

Table 153: Foreign Keys

Table	Column	Referenced Table	Referenced Column
opc_act_cust_attrib	message_number	opc_act_messages	message_number
opc_act_messages	node_id	opc_node_names	node_id
opc_appl_platforms	application_id	opc_application	application_id
opc_applgrp_in_grp	appl_group_id	opc_appl_groups	appl_group_id
opc_applgrp_in_grp	member_appl_grp_id	opc_appl_groups	appl_group_id
opc_hist_cust_attrib	message_number	opc_hist_messages	message_number
opc_hist_messages	node_id	opc_node_names	node_id
opc_instr_in_policy	template_id	opc_source_tmpl	template_id
opc_node_alt_v6_addr	node_id	opc_node_names	node_id
opc_node_cat	category_id	opc_category	category_id
opc_node_cat	node_id	opc_nodes	node_id
opc_node_cat_config	category_id	opc_category	category_id
opc_node_cat_config	node_id	opc_nodes	node_id
opc_node_config	node_id	opc_nodes	node_id
opc_node_config	template_id	opc_source_tmpl	template_id
opc_nodehier_layout	node_id	opc_nodes	node_id

Foreign Keys , continued

Table	Column	Referenced Table	Referenced Column
opc_nodegrp_cat	category_id	opc_category	category_id
opc_nodegrp_cat	node_group_id	opc_node_groups	node_group_id
opc_nodehier_layout	nodehier_id	opc_nodehiers	nodehier_id
opc_nodehier_layout	parent_id	opc_nodehier_layout	layout_id
opc_nodehiers	new_obj_layout_id	opc_nodehier_layout	layout_id
opc_nodes_in_group	node_group_id	opc_node_groups	node_group_id
opc_nodes_in_group	node_id	opc_nodes	node_id
opc_op_desk	application_id	opc_application	application_id
opc_op_desk	user_id	opc_user_data	user_id
opc_op_filter	filter_id	opc_filter	filter_id
opc_op_filter	user_id	opc_user_data	user_id
opc_op_group_desk	appl_group_id	opc_appl_groups	appl_group_id
opc_op_group_desk	user_id	opc_user_data	user_id
opc_op_profiles	profile_id	opc_user_data	user_id
opc_op_profiles	user_id	opc_user_data	user_id
opc_op_realm	msg_group_name	opc_message_groups	name
opc_op_realm	node_group_id	opc_node_groups	node_group_id
opc_op_realm	user_id	opc_user_data	user_id
opc_op_services	user_id	opc_user_data	user_id
opc_op_source_tmpl	source_type_id	opc_policy_type	policy_type_num
opc_policy_attr	policy_id	opc_source_tmpl	template_id
opc_policy_body	policy_id	opc_source_tmpl	template_id
opc_policy_cat	category_id	opc_category	category_id
opc_policy_cat	template_id	opc_source_tmpl	template_id

Foreign Keys , continued

Table	Column	Referenced Table	Referenced Column
opc_service_log	service_name	opc_service	service_name
opc_tmpl_in_tgrp	templ_group_id	opc_tmpl_groups	templ_group_id
opc_tmpl_in_tgrp	template_id	opc_source_tmpl	template_id
opc_tmpl_on_ngrp	node_group_id	opc_node_groups	node_group_id
opc_tmpl_on_ngrp	template_id	opc_source_tmpl	template_id
opc_tmplgrp_cat	category_id	opc_category	category_id
opc_tmplgrp_cat	templ_group_id	opc_tmpl_groups	templ_group_id
opc_tgrp_in_tgrp	member_grp_id	opc_tmpl_groups	templ_group_id
opc_tgrp_in_tgrp	templ_group_id	opc_tmpl_groups	templ_group_id
opc_tgrp_on_ngrp	templ_group_id	opc_tmpl_groups	templ_group_id
opc_tgrp_on_node	node_id	opc_nodes	node_id
opc_tgrp_on_node	templ_group_id	opc_tmpl_groups	templ_group_id
opc_tgrp_on_node	node_id	opc_nodes	node_id
opc_tgrp_on_node	templ_group_id	opc_tmpl_groups	templ_group_id
opc_tmpl_on_node	node_id	opc_nodes	node_id
opc_tmpl_on_node	template_id	opc_source_tmpl	template_id
opc_user_data	nodehier_id	opc_nodehiers	nodehier_id

Appendix A: Database Changes

Database Changes with HPOM 9.xx

This appendix describes the changes in the database that are introduced with HPOM 9.xx. These changes can be divided into the following major groups:

UTF-8 Encoding

The HPOM 9.xx database uses UTF-8 encoding (the AL32UTF8 character set). To accommodate larger strings (non-English characters can take up to four bytes), the size of all `varchar2` fields are doubled, up to a maximum of 4000 bytes.

Fields

Several fields are made longer. For example:

- Text part for annotations, instructions, messages, and conditions (`varchar2(4000)`)
- User name and real name (`varchar2(128)`)
- Policy and policy group names (`varchar2(508)`)
- Calls for the automatic and operator initiated actions (`varchar2(4000)`)

Obsolete Tables

The following tables are obsolete:

- Audit tables (`opc_audit` and `opc_audit_param`)
- Template tables (`opc_logfile_source`, `opc_console_source`, `opc_interf_source`, `opc_monitor_source`, `opc_sched_source`, `opc_trap_source`, `opc_ec_source`, `opc_msg_cond`, `opc_trap_cond`, and `opc_monitor_cond`)
- `opc_agent_status` table

New Tables

[Table 154](#) lists the tables that are new with HPOM 9.xx.

Table 154: HPOM9.xx Tables

Table	Description
opc_category	See "opc_category Table" on page 44.
opc_filter	See "opc_filter Table" on page 146.
opc_instr_in_policy	See "opc_instr_in_policy Table" on page 146.
opc_license_count	See "opc_license_count Table" on page 145.
opc_license_info	See "opc_license_info Table" on page 145.
opc_node_cat	See "opc_node_cat Table" on page 61.
opc_node_cat_config	See "opc_node_cat_config Table" on page 62.
opc_nodegrp_cat	See "opc_nodegrp_cat Table" on page 68.
opc_op_filter	See "opc_op_filter Table" on page 145.
opc_platform_dictionary	See "opc_platform_dictionary Table" on page 83.
opc_policy_attr	See "opc_policy_attr Table" on page 144.
opc_policy_body	See "opc_policy_body Table" on page 143.
opc_policy_cat	See "opc_policy_cat Table" on page 85.
opc_policy_type	See "opc_policy_type Table" on page 142.
opc_s2s_sync	See "opc_s2s_sync Table" on page 142.
opc_temp_msgkey_list	Reserved for future use.
opc_temp_var_attrbs_list	Reserved for future use.
opc_templgrp_cat	See "opc_templgrp_cat Table" on page 85.

New Fields in the Existing Tables

- The info comment field (varchar2(4000)) is now used with the following configuration objects:
 - Nodes (opc_nodes)
 - Node groups (opc_node_groups)

- Node hierarchies (opc_nodehiers)
 - Policies (opc_source_tmpl)
 - Policy groups (opc_tmpl_groups)
 - Application (opc_application)
 - Application groups (opc_appl_groups)
 - Message groups (opc_message_groups)
 - User (opc_user_data)
- The opc_net_machine table contains the following new fields: os_family, os_type, cpu_type, pltf_abs_name, lcore_os_type_num, and lcore_cpu_type_num.

For details, see ["opc_net_machine Table" on page 49](#).
 - The opc_source_tmpl table contains the following new fields: container_id, pol_type_id, templ_version, policy_hdr_checksum, plugin_id, plugin_name, plugin_descript, autopass_id, and syntax_version.

For details, see ["opc_source_tmpl Table" on page 87](#).
 - The opc_tmpl_in_tgrp, opc_tmpl_on_node, and opc_tmpl_on_ngrp tables contain the following new fields: container_id and latest.

For details, see ["opc_tmpl_in_tgrp Table" on page 89](#), ["opc_tmpl_on_node Table" on page 94](#), and ["opc_tmpl_on_ngrp Table" on page 90](#).
 - The opc_node_config table contains the following new fields: container_id and cluster_package.

For details, see ["opc_node_config Table" on page 86](#).
 - The opc_tmpl_groups table contains the following new field: parent_id.

For details, see ["opc_tmpl_groups Table" on page 89](#).
 - The opc_mgmtsv_config table contains the following new fields: opccfgupld_active, opccfgupld_mode, opccfgupld_area, and s2s_sync_buf_state.

For details, see ["opc_mgmtsv_config Table" on page 46](#).

- The `opc_op_realm` table contains the following new field: `read_only`.

For details, see ["opc_op_realm Table" on page 41](#).

- The `opc_act_messages` and `opc_hist_messages` tables contain the following new field: `anno_count`.

For details, see ["opc_act_messages Table" on page 107](#) and ["opc_hist_messages Table" on page 118](#).

- The `opc_user_data` table contains the following new field: `see_all`.

For details, see ["opc_user_data Table" on page 42](#).

- The `opc_node_groups` table contains the following new field: `parent_id`.

For details, see ["opc_node_groups Table" on page 68](#).

- The `opc_nodes` table contains the following new fields: `status1`, `local_status1`, `status2`, `local_status2`, `status3`, `local_status3`, `status4`, `local_status4`, `status5`, and `local_status5`.

For details, see ["opc_nodes Table" on page 72](#).

Fields with Additional Values

For example, the `source_type_id` field in the `opc_source_tmpl` table has additional values. Because new policy types can be added, no fixed list of policy types exists. To obtain all the currently defined policy types, run the following command:

```
# /opt/OV/bin/OpC/utils/opcpoltype -list -full
```

The following predefined policy types are introduced with HPOM 9.xx:

- 512...Service_Process_Monitoring
- 1024...Windows_Management_Interface
- 2048...Windows_Event_Log
- 8192...Service_Auto_Discovery
- 16384...Node_Info

- 65536...ConfigFile
- 69632...Subagent

Diagram of User Tables

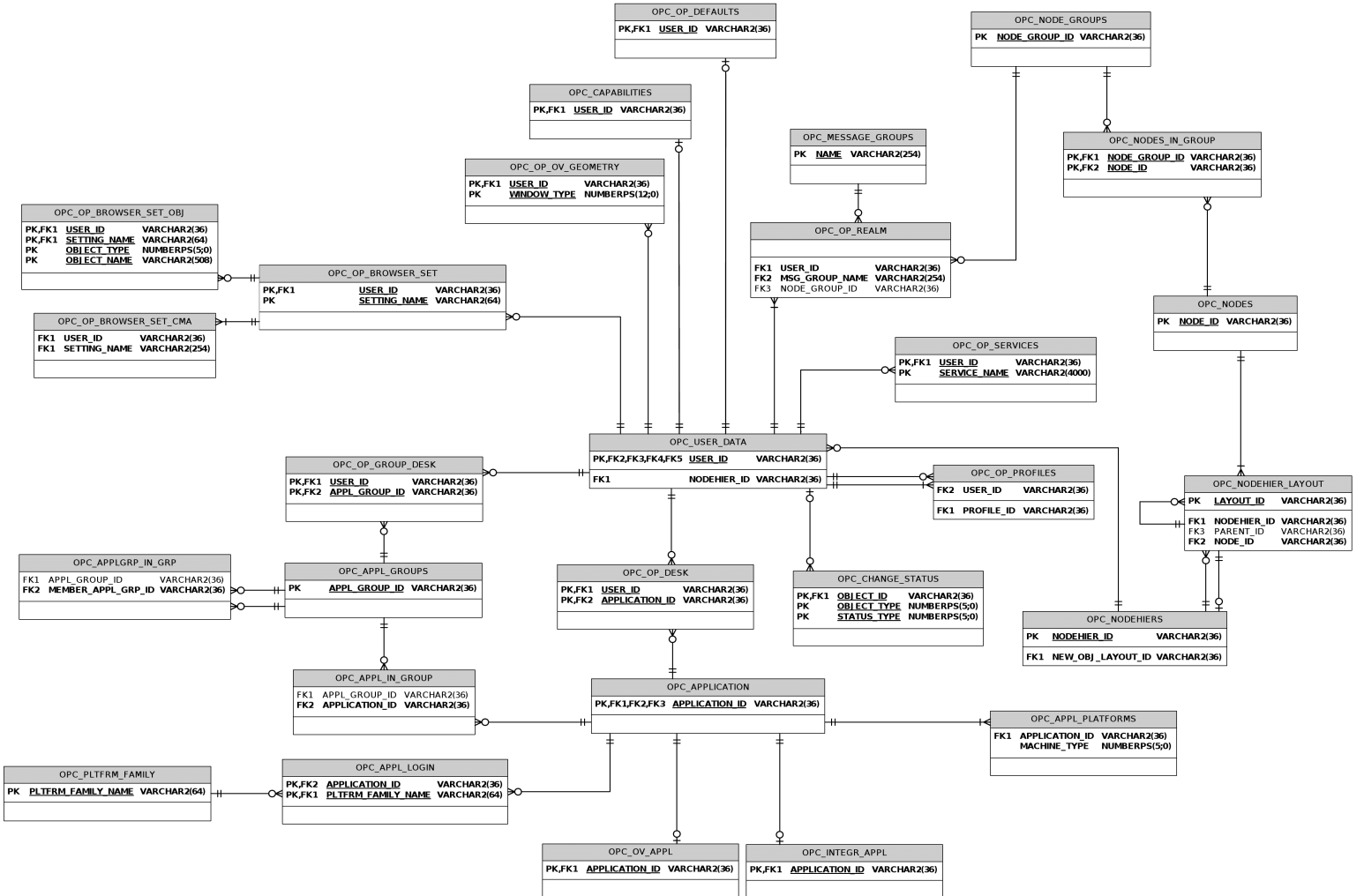

Diagram of Node Tables

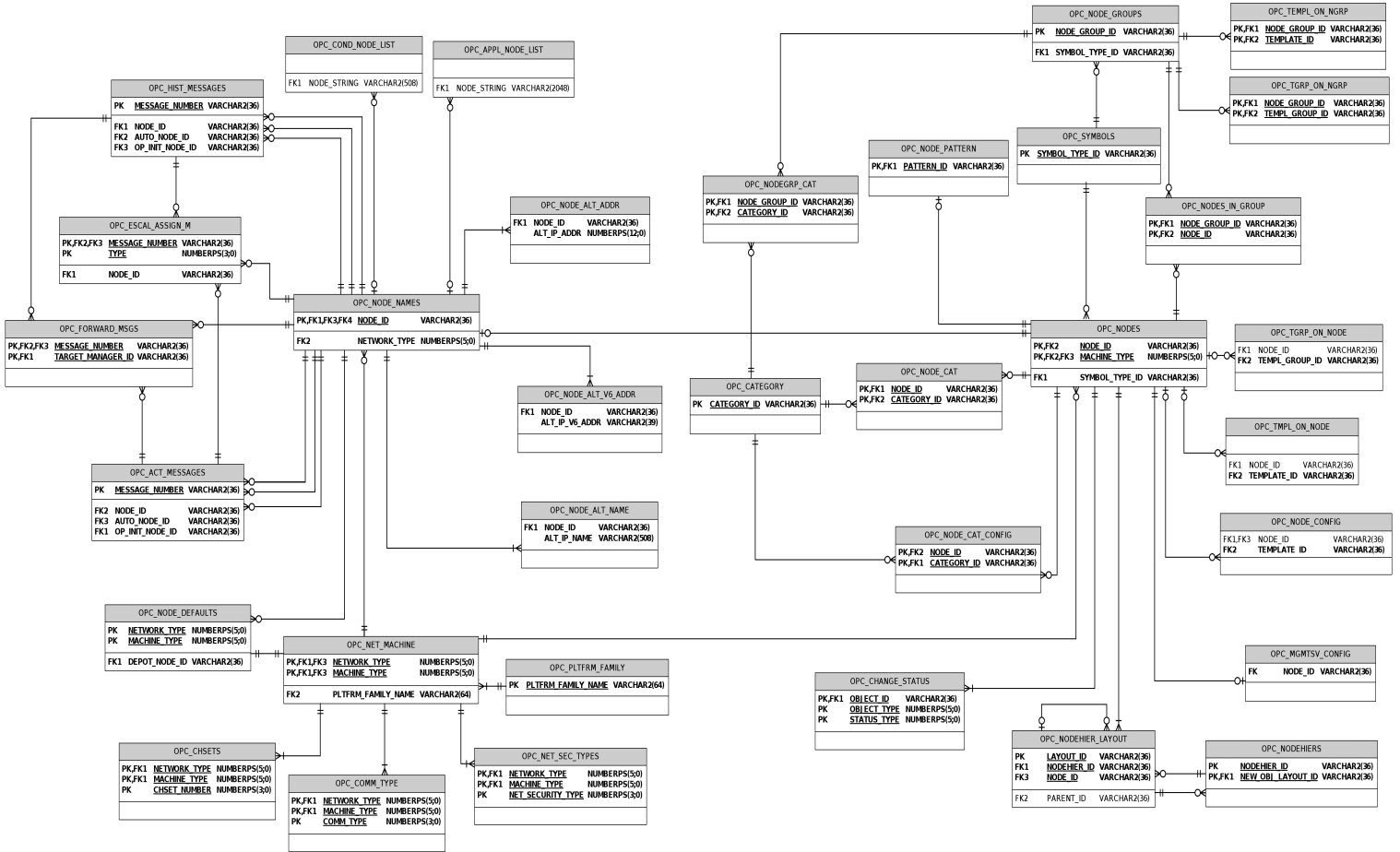

Diagram of Policy Tables

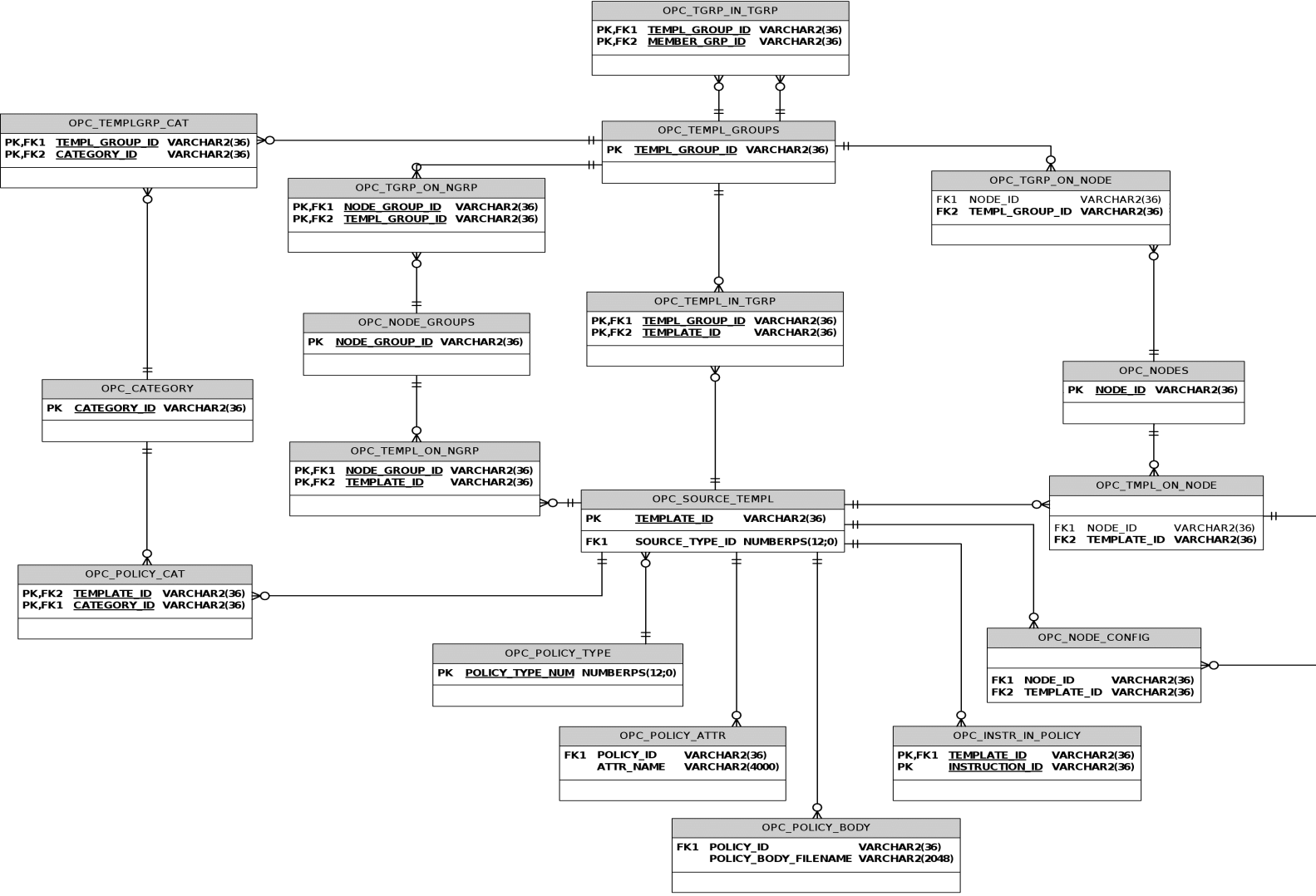
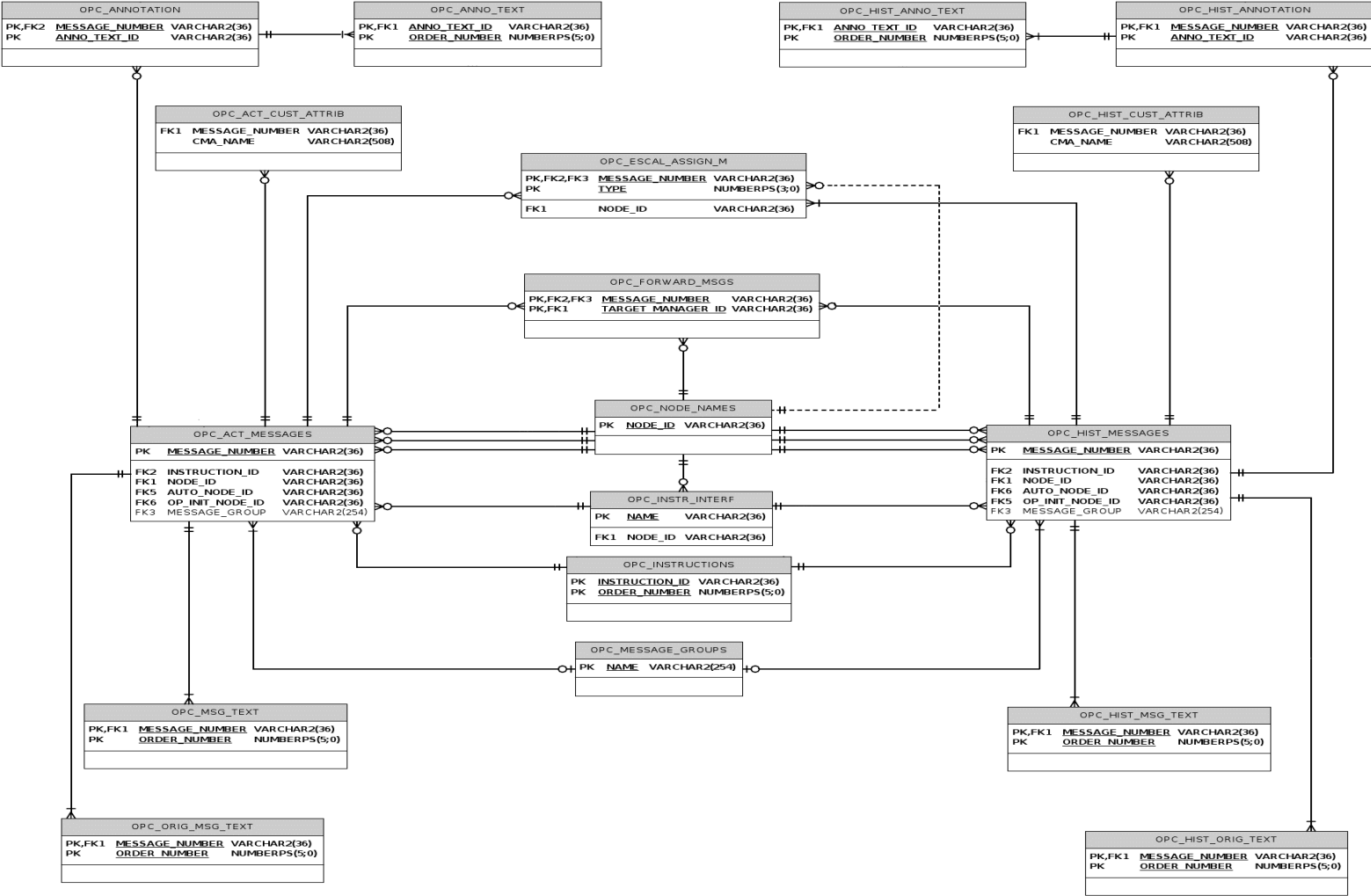

Diagram of Message Tables



Send Documentation Feedback

If you have comments about this document, you can [contact the documentation team](#) by email. If an email client is configured on this system, click the link above and an email window opens with the following information in the subject line:

Feedback on Reporting and Database Schema (Operations Manager 9.22)

Just add your feedback to the email and click send.

If no email client is available, copy the information above to a new message in a web mail client, and send your feedback to docfeedback@hpe.com.

We appreciate your feedback!