



Hewlett Packard
Enterprise

HPE Network Node Manager i Software

Software Version: 10.20
for the Windows® and Linux® operating systems

Online Help: Using the Console

Document Release Date: June 2016
Software Release Date: June 2016

Legal Notices

Warranty

The only warranties for HPE products and services are set forth in the express warranty statements accompanying such products and services. Nothing herein should be construed as constituting an additional warranty. HPE shall not be liable for technical or editorial errors or omissions contained herein.

The information contained herein is subject to change without notice.

Restricted Rights Legend

Confidential computer software. Valid license from HPE required for possession, use or copying. Consistent with FAR 12.211 and 12.212, Commercial Computer Software, Computer Software Documentation, and Technical Data for Commercial Items are licensed to the U.S. Government under vendor's standard commercial license.

Oracle Technology — Notice of Restricted Rights

Programs delivered subject to the DOD FAR Supplement are 'commercial computer software' and use, duplication, and disclosure of the programs, including documentation, shall be subject to the licensing restrictions set forth in the applicable Oracle license agreement. Otherwise, programs delivered subject to the Federal Acquisition Regulations are 'restricted computer software' and use, duplication, and disclosure of the programs, including documentation, shall be subject to the restrictions in FAR 52.227-19, Commercial Computer Software-Restricted Rights (June 1987). Oracle America, Inc., 500 Oracle Parkway, Redwood City, CA 94065.

For the full Oracle license text, see the license-agreements directory on the NNMi product DVD.

Copyright Notice

© Copyright 2008–2016 Hewlett Packard Enterprise Development LP

Trademark Notices

Adobe® is a trademark of Adobe Systems Incorporated.

Apple is a trademark of Apple Computer, Inc., registered in the U.S. and other countries.

AMD is a trademark of Advanced Micro Devices, Inc.

Google™ is a registered trademark of Google Inc.

Intel®, Intel® Itanium®, Intel® Xeon®, and Itanium® are trademarks of Intel Corporation in the U.S. and other countries.

Linux® is the registered trademark of Linus Torvalds in the U.S. and other countries.

Internet Explorer, Lync, Microsoft, Windows, and Windows Server are either registered trademarks or trademarks of Microsoft Corporation in the United States and/or other countries.

Oracle and Java are registered trademarks of Oracle and/or its affiliates.

Red Hat® Enterprise Linux Certified is a registered trademark of Red Hat, Inc. in the United States and other countries.

sFlow is a registered trademark of InMon Corp.

UNIX® is a registered trademark of The Open Group.

Acknowledgements

This product includes software developed by the Apache Software Foundation.
(<http://www.apache.org>).

This product includes software developed by the Visigoth Software Society (<http://www.visigoths.org/>).

Documentation Updates

The title page of this document contains the following identifying information:

- Software Version number, which indicates the software version.
- Document Release Date, which changes each time the document is updated.
- Software Release Date, which indicates the release date of this version of the software.

To check for recent updates or to verify that you are using the most recent edition of a document, go to:

<https://softwaresupport.hp.com>

This site requires that you register for an HP Passport and sign in. To register for an HP Passport ID, go to:

<https://hpp12.passport.hp.com/hppcf/createuser.do>

Or click the **Register** link at the top of the HP Software Support page.

You will also receive updated or new editions if you subscribe to the appropriate product support service. Contact your HP sales representative for details.

Support

Visit the HP Software Support Online web site at: **<https://softwaresupport.hp.com>**

This web site provides contact information and details about the products, services, and support that HP Software offers.

HP Software online support provides customer self-solve capabilities. It provides a fast and efficient way to access interactive technical support tools needed to manage your business. As a valued support customer, you can benefit by using the support web site to:

- Search for knowledge documents of interest
- Submit and track support cases and enhancement requests
- Download software patches
- Manage support contracts
- Look up HP support contacts
- Review information about available services
- Enter into discussions with other software customers
- Research and register for software training

Most of the support areas require that you register as an HP Passport user and sign in. Many also require a support contract. To register for an HP Passport ID, go to:

<https://hpp12.passport.hp.com/hppcf/createuser.do>

To find more information about access levels, go to:

<https://softwaresupport.hp.com/web/softwaresupport/access-levels>

HP Software Solutions Now accesses the HPSW Solution and Integration Portal Web site. This site enables you to explore HP Product Solutions to meet your business needs, includes a full list of Integrations between HP Products, as well as a listing of ITIL Processes. The URL for this Web site is

<http://h20230.www2.hp.com/sc/solutions/index.jsp>

About this PDF Version of Online Help

This document is a PDF version of the online help. This PDF file is provided so you can easily print multiple topics from the help information or read the online help in PDF format. Because this content was originally created to be viewed as online help in a web browser, some topics may not be formatted properly. Some interactive topics may not be present in this PDF version. Those topics can be successfully printed from within the online help.

Contents

Chapter 1: About the NNMi Console	1
Configure How Mozilla Firefox Responds to NNMi Requests	4
Configure Mozilla Firefox Timeout Interval	5
Configure How Microsoft Internet Explorer Responds to NNMi Requests	5
Configure the Microsoft Internet Explorer Title Bar	5
Chapter 2: About the Smart Plug Ins (iSPIs)	7
Chapter 3: Navigating the Console	10
Display Views	10
Access Object Information (Forms and Analysis Pane)	12
Invoke Actions	12
Use the Tools Menu	13
Access Help	15
Search the Help Topics	17
Mark Your Favorite Help Topics	18
Chapter 4: About Workspaces	19
Chapter 5: Views Available in NNMi	24
Views available in the Dashboards Workspace	25
Views for Incident Management	30
Views of Topology Maps	31
Views for Monitoring Network Devices	38
Views for Troubleshooting	40
Views with Inventory Lists	41
Views into Management Mode	43
Views for Incident Browsing	44
Views for Performance Analysis	46
Views for Acme IP Telephony	47
Views for Cisco IP Telephony	47
Views for Nortel IP Telephony	48
Views for Avaya IP Telephony	49
Views for Microsoft IP Telephony	50
Views for MPLS	51
Views for IP Multicast	52
Views for Quality Assurance	53
Views for Traffic Analysis	54
Chapter 6: Using Views to Display Data	56
Select Multiple Objects	57
Refresh a View	58
Use Dashboard Views	58
Launch a Dashboard View from the Dashboard Workspace	58

Dashboard Views based on an Object	59
Launch an Object-based Dashboard View	59
Customize a Dashboard View	59
Customize Charts	60
Minimize or Restore Dashboard Panels	62
Use Table Views	63
Resize a Column	63
Hide a Column	64
Display a Hidden Column	64
Select all Rows in a Table	64
Sort Column Data	65
Stop Periodic Refresh of a View	66
Filter a Table View	67
Filter Tables by Node or Interface Group	69
About Node and Interface Groups	70
Filter by Time Period (Incident Views Only)	70
Filter by Attribute Value	71
Select Filter Values	71
Create a Filter to Specify Values	72
Use Null Value Filters	76
Modify a Table View Filter	76
Remove a Filter	80
Restore Default Filters	80
Display Current Filter Settings	80
Restore Table Defaults	81
Export Table Information	82
Limits to View Settings	83
Use Map Views	84
Understand Maps	85
About Status Colors	85
Status Color for Objects	86
Status Color for Aggregator Objects (NNMi Advanced)	87
Status Color for Network Connections	89
About Map Symbols	92
Node Group Map Objects	98
Layer 2 Map Objects	99
Layer 3 Map Objects	103
Path View Map Objects	104
Navigate Maps	105
Change the Map Layout	106
Toggle Map Object's Label Text	109
Adjust the Zoom Factor	109
Pan Around the Map	110
Set the Location of the Overview Pane	111
Find a Node in a Map	112
Refresh Node Status on a Map	112
Control Tool Tips Information on a Map	113
Access Maps Provided by NNMi	113

Chapter 7: Using Hypervisor Diagrams and Dialogs	116
Using the Wheel Dialog	117
Using the Loom Dialog	136
Chapter 8: About the Analysis Pane	156
Chapter 9: Using the View Toolbars	159
Chapter 10: Using the Form Toolbar	168
Chapter 11: Working with Objects	169
Access a Subset of the Available Information About a Related Object	170
Access All Information About a Related Object	170
Modify Object Attribute Values	171
Chapter 12: Using Actions to Perform Tasks	173
NNM iSPI Performance for Metrics Actions	176
Chapter 13: Displaying Information About NNMi	178
System Information: Product Tab	178
System Information: Health Tab	179
System Information: Server Tab	180
System Information: Global Network Management Tab	182
System Information: Database Tab	182
System Information: State Poller Tab	183
System Information: Custom Poller Tab	183
System Information: Causal Engine Tab	184
System Information: Extensions Tab	185
System Information: Integrations Tab	186
System Information: Devices Tab	186
System Information: Component Versions Tab	187
Chapter 14: Displaying NNMi Version and License Information	188
Glossary	189
Send Documentation Feedback	194

Chapter 1: About the NNMi Console

The HPE Network Node Manager (NNMi) console is the graphical user interface for your NNMi application. The main features of the console are shown in the following diagram and explained in the table below.

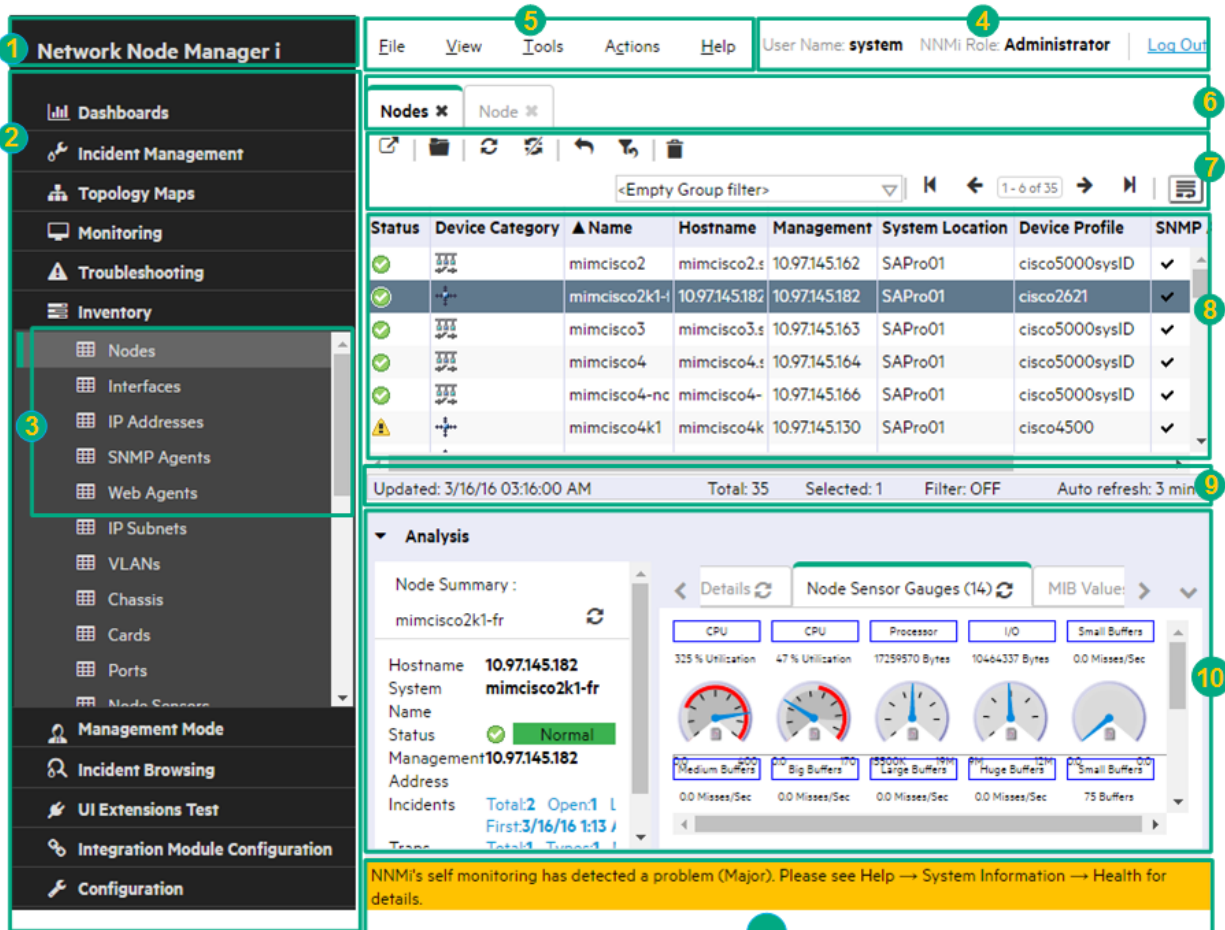

When using the NNMi console, note the following:

- If you are using Microsoft Internet Explorer as your browser, you can sign into multiple NNMi sessions on the NNMi server if you use a different user name for each browser session.
- If you are using Mozilla Firefox as your browser, you can only sign into a single NNMi session on each NNMi server (for example, the Global NNMi server and each Regional NNMi server).
- You can bookmark the URL for the NNMi console.
- By default, NNMi displays menus, views, and workspaces that require an additional license. If your NNMi server does not have the required license, NNMi adds the word Unlicensed or Evaluation (caused by the License Type Instant-On or Temporary) to the end of the menu item name or view title.

Note: The NNMi Administrator can configure the User Interface to hide Unlicensed or Evaluation features.

Network Node Manager Console Features

Feature	Description
1 Title bar	Used to identify the application you are running. The top-right corner contains the standard browser buttons for closing and resizing the console window.
2 Workspace navigation panel	Helps you navigate between workspaces and views. See "Display Views" on page 10 and "About Workspaces" on page 19 .
3 Views	<p>A context that represents your current scope of interest and work. Workspaces provide a means of grouping views for a related purpose or task flow. Multiple views are available in each workspace. See "Views Available in NNMi" on page 24.</p> <p>Note: You will see some or all of the workspaces and views described, depending on several factors:</p> <ul style="list-style-type: none"> • Your assigned NNMi Security Group Mapping. • The HPE Network Node Manager i Smart Plug-in software currently installed. • Your NNMi administrator can integrate other applications into NNMi. Therefore, you might see things that are not described in the NNMi online help. Contact your NNMi administrator if you have questions about any additional items that are not described.
4 User, Role, and Sign Out button	Your current user name, and role assignment. Your role assignment determines what you can see and do within the NNMi console.
5 Main menu bar	<p>Commands available in the console from within the menu structure:</p> <ul style="list-style-type: none"> • <u>F</u>ile • <u>V</u>iew (see "Refresh a View" on page 58 and "Restore Table Defaults" on page 81) • <u>T</u>ools (see "Use the Tools Menu" on page 13) • <u>A</u>ctions (see "Invoke Actions" on page 12 and "Using Actions to Perform Tasks" on page 173) • <u>H</u>elp (see also "Access Help" on page 15 and "Search the Help Topics" on page 17) <p>Tip: To expand NNMi menus, you can click with the mouse or use Ctrl-Shift and the underlined character (if any). NNMi uses Ctrl-Shift (instead of Alt) to avoid the browser's main menu behavior. For example, NNMi provides Ctrl-Shift+H, then n for Help → NNMi Documentation Library. If the NNMi menu does not expand as expected, your browser configuration already over-rides the NNMi configuration for that keyboard combination of Ctrl-Shift+<ASCII character>.</p>
6 Tabs	Title of each view and form currently displayed. Each view provides access to a group of objects. More details about each object are available when you double-click the object to display that object's form. See "Using Views to Display Data" on page 56 , "Access Object

Network Node Manager Console Features , continued

Feature	Description
	<p>Information (Forms and Analysis Pane)" on page 12, and "Working with Objects" on page 169. The tabs allow you to easily navigate between multiple views and forms.</p>
7 View Toolbar	<p>Tools available within the current view or form. These tools enable you to remove any data filters that you previously applied, restore any columns that you previously hid, and manipulate objects within the view. See "Using the View Toolbars" on page 159 for more information.</p> <p>The drop-down selectors enable you to modify the factory-set filter values applied to the visible data. See "Filter a Table View" on page 67.</p>
8 Content Pane	<p>Displays the currently selected view or form.</p>
9 Status Bar	<p>In table views, the Status Bar shows the following information:</p> <ul style="list-style-type: none"> Total. The current number of objects in the database that match the criteria for this table (each row displays data about one object). <div data-bbox="396 856 1408 1081" style="background-color: #f0f0f0; padding: 10px; margin: 10px 0;"> <p>Note: You might also see a LIMIT number. This indicates that HPE Network Node Manager i Software Smart Plug-ins (iSPIs) software, has set a limit for the current view. This number appears when the number of objects that match the criteria for the current table exceeds the number of rows allowed. See "Help for Administrators" for more information about NNM iSPIs software.</p> </div> <div data-bbox="396 1102 1408 1222" style="background-color: #f0f0f0; padding: 10px; margin: 10px 0;"> <p>Tip: To reduce the number of objects displayed so that you see only the objects of interest, use filters.</p> </div> <ul style="list-style-type: none"> Selected: Indicates the number of rows selected in the table. Filter. Indicates if the currently displayed data is a filtered subset of available objects. See "Filter a Table View" on page 67. Auto Refresh. Indicates the current refresh time interval. See "Refresh a View" on page 58. <p>In map views, the Status Bar shows the following information:</p> <ul style="list-style-type: none"> The number of nodes displayed on the map. Auto status refresh. Automatic refresh rate for the Refresh Status option. See "Refresh Node Status on a Map" on page 112. To update other aspects of the map data (changes in node placement, nodes added, and nodes deleted), see "Refresh a View" on page 58. <div data-bbox="396 1648 1408 1768" style="background-color: #f0f0f0; padding: 10px; margin: 10px 0;"> <p>Note: The Initial Discovery Progress map indicates the refresh rate for Auto full refresh, which refreshes both status and topology.</p> </div> <p>In both table and map views, the Status Bar displays the Last Updated time to indicate the time at which the view was last refreshed.</p>

Network Node Manager Console Features , continued

Feature	Description
10 Analysis Pane	Displays additional information about the object selected in the Content Pane. Examples of additional information include details about an incident's Source Node and Source Object or information about a node's Interfaces and IP Addresses. Note: This pane remains blank until an object is selected.
11 Console message bar	Alerts about any problems with NNMi, itself.

Configure How Mozilla Firefox Responds to NNMi Requests

By default, NNMi opens Online help in a new browser window.

In the main console window,  opens a duplicate of the current view or form in a new browser window.

To control the number of windows generated, you can configure Mozilla Firefox so NNMi responds to requests in a new tab within the current Firefox window.

To configure how Mozilla Firefox responds to NNMi links:

1. Open a Mozilla Firefox browser window.
2. In the URL field, type `about:config` and press **Enter**.
3. At the top of the displayed form, in the field labeled **Filter**, type `newwindow`. A list of relevant attributes displays.
4. Double-click `browser.link.open_newwindow`.
5. In the **Enter integer value** dialog box, type one of the following choices:
 - 1** = Replace the current Firefox window/tab.
 - 2** = Open a new Firefox window.
 - 3** = Open a new tab within the current Firefox window.
6. Click **OK** to save your changes and close the dialog box.
7. Double-click `browser.link.open_newwindow.restriction`.
8. In the **Enter integer value** dialog box, type one of the following choices:
 - 0** = Use settings in `browser.link.open_newwindow`.
 - 1** = Ignore settings in `browser.link.open_newwindow`.
 - 2** = Use settings in `browser.link.open_newwindow` unless the URL contains other window instructions.
9. Click **OK** to save your changes and close the dialog box.

Related Topics

["Configure How Microsoft Internet Explorer Responds to NNMi Requests" on the next page](#)

Configure Mozilla Firefox Timeout Interval

If you use the Mozilla Firefox browser and have timeout issues (for example, being prompted to Continue before a map appears), try resetting the Mozilla Firefox timeout value:

1. In the Mozilla Firefox address bar, type: `about:config`
2. Select the **dom.max_script_run_time** entry from the scroll-down list.
3. Increase the value displayed. For example, enter 0 (zero) to set the timeout value to infinity.

Configure How Microsoft Internet Explorer Responds to NNMi Requests

By default, NNMi opens Online help in a new browser window.

In the main console window,  opens a duplicate of the current form or view in a new browser window.

To control the number of windows generated, you can configure Microsoft Internet Explorer so NNMi responds to requests in a new tab within the current Explorer window.

To configure how Microsoft Internet Explorer responds to NNMi requests:

1. From the Microsoft Internet Explorer browser, select **Tools** → **Internet Options**
2. Select the **General** tab.
3. Under the **Tabs** section, click **Settings**.
4. In the **Tabbed Browsing Settings** dialog, locate the radio box group labeled **When a pop-up is encountered**.
5. Make your selection:
 - **Let Internet Explorer decide...**
 - **Always open pop-ups in a new window**
 - **Always open pop-ups in a new tab**
6. Click **OK** to save your configuration and close the dialog box.
7. Click **OK** to close the **Internet Options** dialog and return to the browser window.

Related Topics

["Configure How Mozilla Firefox Responds to NNMi Requests" on the previous page](#)

Configure the Microsoft Internet Explorer Title Bar

When using Internet Explorer, browser settings determine whether the name of an NNMi view or form displays in the title bar.

To configure Microsoft Internet Explorer to display view and form titles:

1. Open the Internet Explorer browser and click the **Tools** menu.
2. Select **Internet Options**.
3. Navigate to the **Security** tab, **Trusted Sites, Custom Level, Miscellaneous** section.
4. Disable the **Allow websites to open windows without address or status bars** attribute

Chapter 2: About the Smart Plug Ins (iSPIs)

HPE Network Node Manager i Software Smart Plug-ins (iSPIs) for Performance and Advanced Network Services extend the device and protocol support of NNMi to enable monitoring and management of a wide range of network devices, services, and facilities. These Smart Plug-ins provide technology-specific awareness that can provide a broader and more detailed perspective to quickly isolate faults and improve the efficiency of your network operations team:

- Adaptive baselines and dynamic thresholds identify normal usage patterns, accelerate implementation efforts, identify cost cutting opportunities, and quickly highlight performance anomalies.
- Fully integrated discovery, monitoring, and reporting of your MPLS, IP Multicast, and IP Telephony environments provide a detailed context within which to manage these services.
- Quality assurance probes provide synthetic transactions to measure and report on latency and variability throughout your network fabric.
- Traffic flow collection and consolidation identifies application traffic patterns throughout the network fabric.

These Smart Plug-ins provide technology-specific awareness that quickly identifies a problem and reduces Mean Time to Repair (MTTR). Simply install and configure each iSPI:

- **HPE Network Node Manager iSPI for IP Multicast Software:**

With the NNM iSPI for IP Multicast, you can:

- Discover and analyze any Multicast environment in real-time.
- Perform baseline snapshots and compare them with active flows.
- Utilize "[Views for IP Multicast](#)" on page 52 and "[Views for Troubleshooting](#)" on page 40 to see elements such as neighbor views, forwarding paths, and reverse paths.

For more information, search NNMi Help for: "IP Multicast"

- **HPE Network Node Manager iSPI for IP Telephony Software:**

With the NNM iSPI for IP Telephony, you can:

- Manage the fault and availability of Voice Over IP (VoIP) in a multi-vendor environment (Acme, Avaya, Cisco, Microsoft Lync, and Nortel):
- Analyze the impact of network performance on your VoIP environment.
- Troubleshoot with many tools provided by this iSPI.

For more information, search NNMi Help for: "IP Telephony"

- **HPE Network Node Manager iSPI for MPLS Software:**

If you are on a service provider's team, the NNM iSPI for MPLS helps your team ensure that customer obligations are met:

- Actively monitor the provider equipment (PE) and customer edge (CE) Multiprotocol Label Switching (MPLS) devices that provide network access: ["Views for MPLS" on page 51](#)
- Monitor the effects of interface availability and site impact. See ["Views for MPLS" on page 51](#).
- Analyze core MPLS virtual private network (VPN) availability.
- Automate discovery of Virtual Routing and Forwarding (VRF) neighbors including remote provider equipment (PE routers).
- Generate performance reports about Label-Switched Paths (LSPs) and root-cause analysis for Traffic Engineering tunnel issues (RCA for TE Tunnel).

For more information, search NNMi Help for: "iSPI for MPLS"

- [HPE Network Node Manager iSPI Network Engineering Toolset Software:](#)

The NNM iSPI NET provides automated diagnostic flows and tools for troubleshooting the toughest of network issues. NNM iSPI NET saves operators significant time and effort when diagnosing network problems or analyzing Trap storms. Results are conveniently provided on the [Node Form: Diagnostics Tab](#) and the [Incident Form: Diagnostics Tab](#).

For more information, search NNMi Help for: "iSPI NET"

- [HPE Network Node Manager iSPI Performance for Metrics Software:](#)

The NNM iSPI Performance for Metrics provides a complete environment for collecting, alarming, and reporting on a wide variety of network performance metrics collected using Node Sensor and Physical Sensor thresholds. Reports include trend and operational analysis statistics for multiple vendor's equipment:

For more information, search NNMi Help for: "Performance for Metrics"

- [HPE Network Node Manager iSPI Performance for Quality Assurance Software:](#)

With the NNM iSPI Performance for QA, you can:

- Monitor the quality of service levels within your network. See ["Views for Quality Assurance" on page 53](#).
- Discover preconfigured Service Level Agreement (SLA) probes and gather the probes' performance metrics.
- Identify SLA exceptions and violations through auto-generated NNMi Incidents.

For more information, search NNMi Help for: "Quality Assurance"

- [HPE Network Node Manager iSPI Performance for Traffic Software:](#)

The NNM iSPI Performance for Traffic is a comprehensive reporting solution that validates whether or not sufficient bandwidth is available for mission critical applications. See ["Views for Traffic Analysis" on page 54](#). The NNM iSPI Performance for Traffic does the following:

- Supports all common diagnostic flow types
- Performs centralized analysis
- Provides a wide range of reports

For more information, search NNMi Help for: "Performance for Traffic"

For more information:

Chapter 3: Navigating the Console

The main window of the console is your starting point for navigation.

A *view* is a collection of related objects that are depicted as a table or map. A *form* provides all known details about a selected object.

From the main window, you can perform the following tasks:

- ["Display Views" below](#)
- ["Access Object Information \(Forms and Analysis Pane\)" on page 12](#)
- ["Invoke Actions" on page 12](#)
- ["Use the Tools Menu" on page 13](#)
- ["Access Help" on page 15](#)
- ["Search the Help Topics" on page 17](#)
- ["Mark Your Favorite Help Topics" on page 18](#)

Display Views

Views contain information about the objects in your network. A view can be a table (a list of objects) or a view can be a map with icons. For example, to assist you in managing incidents, NNMi provides the Open Key Incidents and My Open Incidents table views.

To display a view:

1. Click a workspace name in the workspaces navigation panel to display a group of views. The workspaces provided by NNMi are shown below:

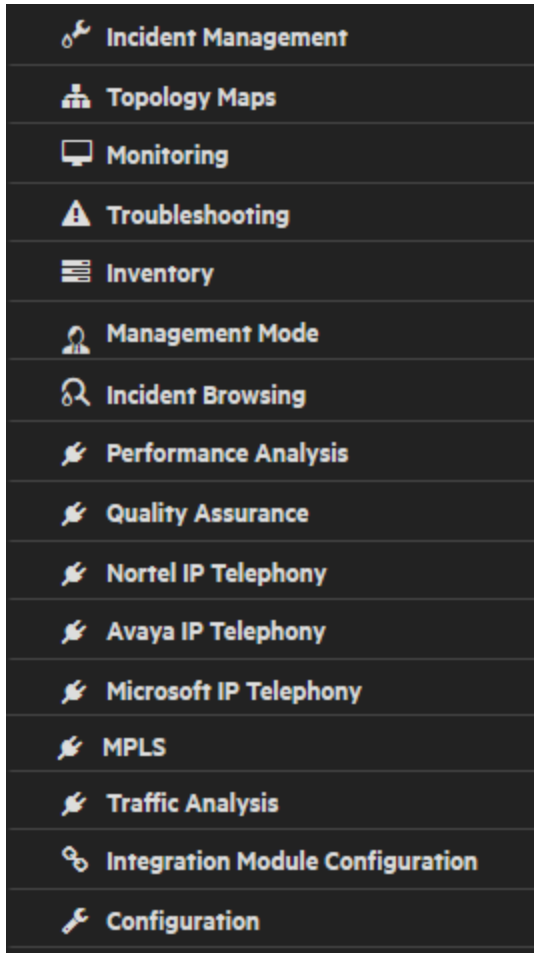

2. Select the view you want. See ["Using Views to Display Data" on page 56](#).

When you select another view from the workspaces navigation panel, the selected view replaces the current view.

In the view toolbar, you can click the  **Show View in New Window** icon to open the view in a new window. See ["Using the View Toolbars" on page 159](#).

If the view has more than one page of information, use the scroll bar or the page controls to navigate through each page of the view. See ["Using the View Toolbars" on page 159](#) for more information about using page control.

See ["Using Actions to Perform Tasks" on page 173](#) for more information about views that are accessible from the console's **Actions** menu.

Tip: You can also right-click any object in a table or map view to access the items available within the **Actions** menu.

Access Object Information (Forms and Analysis Pane)

You can access more information about any object. For example, in your current view, you can obtain more information about a node or interface that was reported as having problems. From within the node or interface form, you can access the associated incidents.

Access all object attributes and related objects by displaying the form:

Tip: A red asterisk (*) that precedes an attribute on a form indicates the attribute requires a value.

- **To open a form using Tools → Find Node:**

See the ["Use the Tools Menu" on the next page](#) for more information.

- **To open a form from a table view:**

Double-click the row representing an object.

The form appears, containing the details about the object. For more information, see ["Working with Objects" on page 169](#).

- **To open a form from a map view:**

Do one of the following:

- Select the map object. Then, click the  Open icon in the toolbar.
- Double-click the map object.

Note: If the map object is a Child Node Group, double-clicking the Child Node Group object replaces the current map with a map containing each of the nodes in the Child Node Group. To access a Child Node Group form, use the  Open icon in the toolbar.

- The form appears, containing the details about the object. For more information, see ["Working with Objects" on page 169](#).

Access more details about an object by using the Analysis Pane: ["About the Analysis Pane" on page 156](#)

Invoke Actions

The actions available to you depend on your NNMI user role and on the object selected. If no actions are available for a particular object, the Actions menu is empty.

To perform an action, you select an object, then select an action from the Actions menu. The Actions menu is accessible from the NNMI console main menu toolbar and from the menu toolbar in any view or form that is opened in a new window.

Tip: To expand NNMI menus, you can click with the mouse or use Ctrl-Shift and the underlined character

(if any). NNMi uses Ctrl-Shift (instead of Alt) to avoid the browser's main menu behavior. For example, NNMi provides Ctrl-Shift+H, then n for **Help** → **NNMi Documentation Library**. If the NNMi menu does not expand as expected, your browser configuration already over-rides the NNMi configuration for that keyboard combination of Ctrl-Shift+<ASCII character>.

- **To invoke an action from a table or map view:**

- a. If you do not have a view displayed, from the workspace navigation panel, select a view.
- b. Do one of the following:
 - In a table view, single-click a row.
 - In a map view, single-click the object of interest.

Tip: For multiple selections, use Ctrl-click.

- c. Select the **Actions** menu in the menu toolbar.

Tip: You can also right-click any object in a table or map view to access the items available within the **Actions** menu.

- d. Select the action you want to perform from the list of available actions.

- **To invoke an action from a form:**

- a. If you do not have a form open, from the workspace navigation panel, select the table view you want to access.
- b. From the table view, double-click the row representing the object instance (for example, node) you want to update.
- c. From the menu toolbar, select Actions and then the action you want. For example, select **Actions** → **Change Lifecycle** → **In Progress** to change the Lifecycle State of the selected incident to In Progress.

When invoking actions, note the following:

- If you are running an action that modifies attributes on a form, the action takes effect immediately. You do not have to select  Save.
- An action might cause a new window to open.
- In the Actions menu, your administrator can add menu choices. Those action items are not described in NNMi Help.

Related Topics

["Using Actions to Perform Tasks" on page 173](#)

Use the Tools Menu

Several tools are provided beneath the **Tools** menu. The list of tools changes depending on the role to which you are assigned. The tools listed in the following table are available to Operator Level 2.

Tip: To expand NNMi menus, you can click with the mouse or use Ctrl-Shift and the underlined character (if any). NNMi uses Ctrl-Shift (instead of Alt) to avoid the browser's main menu behavior. For example, NNMi provides Ctrl-Shift+H, then n for **Help** → **NNMi Documentation Library**. If the NNMi menu does not expand as expected, your browser configuration already over-rides the NNMi configuration for that keyboard combination of Ctrl-Shift+<ASCII character>.

NNMi Tools Menu Options

Tool	Description
Find a Node	Searches the NNMi database for the <i>case-sensitive</i> string of characters you provide. NNMi finds the associated Node. If multiple Nodes match, NNMi displays the Node form of the first match. NNMi checks the following Node attributes for a match: <ul style="list-style-type: none"> • Name • Hostname (<i>fully-qualified</i>) • IP address • MIB-II sysName
Find Attached Switch Port	Identifies the switch port to which the selected node is attached.
MIB Browser	Displays the responses to NNMi's SNMP requests made to a particular node in your network environment, starting from a Management Information Base (MIB) object identifier (OID) within the Internet MIB structure.
NNMi Status	Displays a list showing the status of each process and service of NNMi. When NNMi is functioning properly, each process and service should be running. If one is not running, contact your NNMi administrator.
Status Distribution Graphs	Displays the overall health of your network by providing Stacked Area Graphs that display the distribution of Node, Interface, and IP Address Status information over time.
NNMi Self-Monitoring Graphs	Displays information about NNMi components and their usage: <ul style="list-style-type: none"> • SNMP Trap Pipeline Rate • SNMP Trap Forwarding Rate • Discovery Progress • SNMP Requests
Trap Analysis	<div style="background-color: #e0e0e0; padding: 5px; border: 1px solid #ccc;"> Requires HPE Network Node Manager iSPI Network Engineering Toolset Software (NNM iSPI NET) – click here for more information. </div> <p>NNMi measures the rate of incoming SNMP traps. The NNMi administrator configures thresholds for trap volume within your network. Use this menu item to access the Trap Analytics reports.</p>

NNMi Tools Menu Options , continued

Tool	Description
Visio Export	Requires HPE Network Node Manager iSPI Network Engineering Toolset Software (NNM iSPI NET) – click here for more information . Exports topology maps displayed in NNMi to Visio documents for later use.
Signed In Users	View a list of the NNMi users who are currently signed in to NNMi.
Incident Actions Log	Displays a log of recent Incident Actions (configured by your NNMi administrator to happen when particular incidents are received/generated by NNMi).
Security Reports	<i>(NNMi administrators only)</i> Generate a report of possible NNMi Security configuration problems.

Access Help

If you have a Guest user role, start with the topics in **Help** → **Using the Console**. More information about each view is in **Help** → **Help for Operators**. If you need more information about a form, use the **Help** → **Using the <name> form** within the form.

If you are an Operator, task information is provided in **Help** → **Help for Operators**. If you are an Administrator, all the resources described in [the table below](#) are valuable.

Tip: To expand NNMi menus, you can click with the mouse or use Ctrl-Shift and the underlined character (if any). NNMi uses Ctrl-Shift (instead of Alt) to avoid the browser's main menu behavior. For example, NNMi provides Ctrl-Shift+H, then n for **Help** → **NNMi Documentation Library**. If the NNMi menu does not expand as expected, your browser configuration already over-rides the NNMi configuration for that keyboard combination of Ctrl-Shift+<ASCII character>.

To access the help:

1. Select **Help** from the NNMi console main menu.

Note: Within the NNMi user interface, pressing [F1] does not access context-sensitive help.

2. From the help you can access all the information described in the table below.

Help → Links

Help Link	Description
Using the <name> form	Context-sensitive help for the current form.
Getting Started	Link to Best Practices Tours that explain some of NNMi's capabilities.

Help → Links , continued

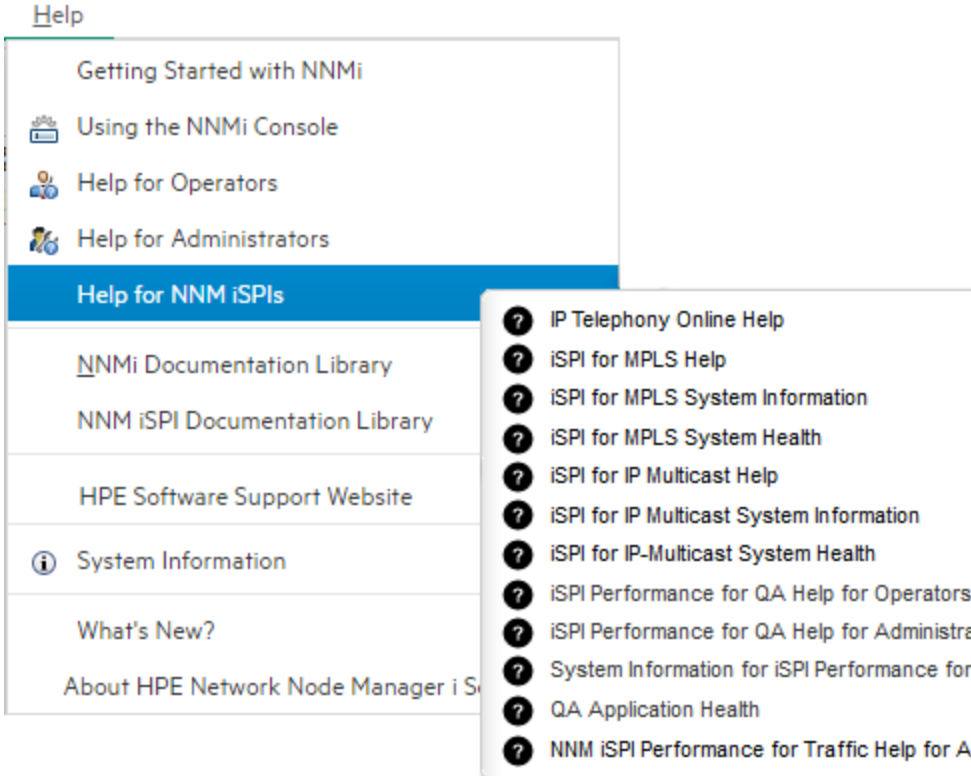
Help Link	Description
with NNMi	
Using the NNMi Console	Explains how to use the NNMi console, including how to navigate within the console, as well as how to access and use the forms and views NNMi provides.
Help for Operators	Describes how to use the views, forms, and additional NNMi features that are useful for monitoring and troubleshooting the network.
Help for Administrators	Explains how NNMi works and how you can configure NNMi to meet your needs. Describes how to use the Configuration workspace that lets you configure a variety of objects and settings for NNMi.
Help for NNM iSPIs	<p>Access more information about the HPE NNM iSPI software currently installed on your NNMi server. Your NNMi administrator must install these programs before their Help entries appear.</p>  <p>The screenshot shows a 'Help' dropdown menu with the following items:</p> <ul style="list-style-type: none"> Getting Started with NNMi Using the NNMi Console Help for Operators Help for Administrators Help for NNM iSPIs (highlighted) NNMi Documentation Library NNM iSPI Documentation Library HPE Software Support Website System Information What's New? About HPE Network Node Manager iSPI <p>The sub-menu for 'Help for NNM iSPIs' includes the following items:</p> <ul style="list-style-type: none"> IP Telephony Online Help iSPI for MPLS Help iSPI for MPLS System Information iSPI for MPLS System Health iSPI for IP Multicast Help iSPI for IP Multicast System Information iSPI for IP-Multicast System Health iSPI Performance for QA Help for Operators iSPI Performance for QA Help for Administrators System Information for iSPI Performance for QA QA Application Health NNM iSPI Performance for Traffic Help for Administrators
NNMi Documentation Library	Provides access to Reference Pages (command line tool information), Release Notes, and more.
HPE Software Support Website	Accesses the HPE Software support web site.
System Information	Health information about NNMi. See " Displaying Information About NNMi " on page

Help → Links , continued

Help Link	Description
	178.
What's New	Describes the NNMi features provided in the current release.
About HPE Network Node Manager i Software	Current NNMi licensing information (total licensed capacity limit compared to the number of nodes currently managed). See " Displaying NNMi Version and License Information " on page 188.

Related Topics

["Search the Help Topics" below](#)

["Mark Your Favorite Help Topics" on the next page](#)

Search the Help Topics

To search for specific information across all help topics:

1. In the top-right corner of the Help window, click the **Search** box.
2. Type in a search string (see [table](#)).
3. Click the  button. The order of the resulting list of topics is based on a ranking order, with highest ranking topics at the top of the list.
4. Click the topic of interest. To return to the search results and make another choice, click the **Backspace** key on your keyboard.

Search Variables

Description	Variable	Example
Search for one or more words. When you enter a group of words into the search field, "or" is inferred.		node interface
Search for a phrase.	" " (wrap a text string in quotes)	"navigation pane"
Search for "either of" or "any of" specific strings.	OR (case insensitive) (pipe symbol)	node or interface or address "node name" "interface status"
Search for two or more specific strings.	AND (case insensitive) + (plus symbol) & (ampersand)	node And interface And address "node name"+address

Search Variables , continued

Description	Variable	Example
		"node name"&"interface"
Search for all topics that do not contain something.	NOT (case insensitive) ! (exclamation mark)	not node ! node
Search for all topics that contain one string and do not contain another.	^ (carat symbol)	node ^ interface
Combinations of the above.	() parenthesis	node and (name or status) node or vlan (!address)

Note: Results returned are case insensitive. However, results ranking takes case into account and assigns higher scores to case matches. Therefore, a search for "templates" followed by a search for "Templates" would return the same number of help topics, but the order in which the topics are listed would be different.

Mark Your Favorite Help Topics

Use the Favorites tab in the Help system to set favorites for your commonly used help topics.

When using this feature, note the following:

- This feature is not related to the Favorites option in your Web browser.
- Any time you delete your Web browser cookies, your help topic favorites list is deleted.

Chapter 4: About Workspaces

A workspace is a collection of views that represent a scope of interest and work. Workspaces group views with a related purpose or task flow.

When you click the name of a workspace, the views associated with that workspace display below the workspace in the workspace navigation panel. After you select a view, the view display panel shows the requested data. See ["About the NNMi Console" on page 1](#) and ["Display Views" on page 10](#) for more information about the workspace navigation and view display panels.





The views within workspaces provide convenient access to information associated with each object type represented. A view displays all the objects of a given type that meet the filter criteria specified for that view.

Note: You will see some or all of the workspaces and views described, depending on several factors:



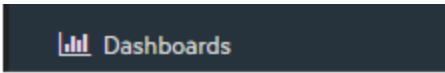

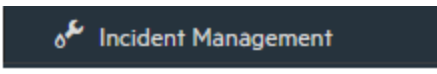



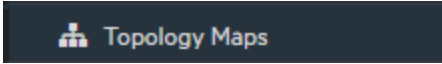

- Your assigned NNMi [Security Group Mapping](#).
- The [HPE Network Node Manager i Smart Plug-in software](#) currently installed.
- Your NNMi administrator can integrate other applications into NNMi. Therefore, you might see things that are not described in the NNMi online help. Contact your NNMi administrator if you have questions about any additional items that are not described.

NNMi includes the following workspaces:



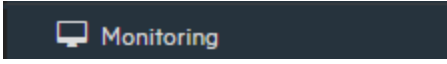

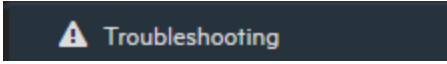

Workspaces in NNMi

Workspace Name	Description:
	<p>Use the  Dashboards workspace to view at-a-glance information about your network. Dashboard views allow you to easily compare and quickly isolate the information you need to manage your network. See "Use Dashboard Views" on page 58 for more information.</p> <p>Requires HPE Network Node Manager iSPI Performance for Metrics Software (NNM iSPI Performance for Metrics). To populate performance data in the dashboard views or enhance NNM iSPI Performance for Metrics reports by sharing NNMi configuration settings, install the <i>optional</i> Network Performance Server (NPS) – click here for more information.</p>
	<p>Use the  Incident Management workspace to access the incidents that are most important to the network Operator and that often require more immediate action, incidents with the Lifecycle State</p>

Workspaces in NNMi, continued

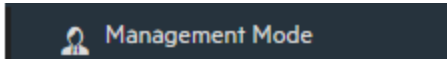

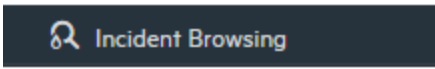
Workspace Name	Description:
	<p>equal to  Registered,  In Progress, or  Completed.</p> <p>See "Views for Incident Management" on page 30 for more information.</p>
	<p>The  Topology Maps workspace includes multiple map views.</p> <p>See "Views of Topology Maps" on page 31 for more information.</p> <div style="background-color: #f0f0f0; padding: 10px; border: 1px solid #ccc;"> <p>Tip: The following changes are not automatically visible in the Topology Maps workspace folders:</p> <ul style="list-style-type: none"> Add one or more Node Groups Delete one or more Node Groups Modify a Node Group hierarchy <p>To view any of these changes, click Refresh  in the upper right-hand corner of the workspace. Refresh  collapses the Node Group maps folders. Expand each folder of interest to view the updated Node Group map list.</p> </div>
	<p>The  Monitoring workspace includes views to check for those node sensors, physical sensors, chassis, cards, interfaces, nodes, SNMP agents, IP addresses, Card Redundancy Groups, Router Redundancy Groups, and Node Groups that have a Status of Critical or other than Normal. This workspace also provides views for checking the health of Custom Polled Collections and Custom Polled Instances.</p> <p>See "Views for Monitoring Network Devices" on page 38 for more information.</p>
	<p>Within the  Troubleshooting workspace, you can access a variety of map views.</p> <p>The Layer 2 Neighbor View map displays Layer 2 network connectivity. The Layer 3 Neighbor View map displays Layer 3 network connectivity. The Path View map displays the active IPv4 addresses in the path between a source and destination node. The Path View map is useful when troubleshooting</p>

Workspaces in NNMi, continued



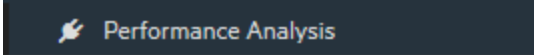

Workspace Name	Description:
	<p>data flow problems. The Node Group Map view displays all nodes within a specified group.</p> <p>See "Views for Troubleshooting" on page 40 for more information.</p>
	<p>Each view in the  Inventory workspace contains information related to the object listed. For example, the Nodes view contains information related to the Nodes object. The Interfaces view contains information related to the Interface object. The IP Subnets view contains information related to the IP Subnet object.</p> <p>See "Views with Inventory Lists" on page 41 for more information.</p>
	<p>The  Management Mode workspace includes views of discovered network elements that are not currently being managed by NNMi ():</p> <p>See "Views into Management Mode" on page 43 for more information.</p>
	<p>The  Incident Browsing workspace includes views for Key Incident¹ filtered on the incident's Lifecycle State. For example, the Open Key Incidents view displays all Key Incidents with Lifecycle State values other than  Closed. The Closed Key Incidents view displays all incidents that have a Lifecycle State of Closed.</p> <p>This workspace also includes views for incidents based on their Correlation Nature. Examples include Open Root Cause Incidents and Service Impact Incidents.</p> <p>You can also use this workspace to view all incidents.</p> <p>NNMi provides the Custom Incident and Custom Open Incident views that include all of the attributes available for an incident. These views are provided so that you can customize the incident views to include only the incident attributes of interest.</p> <p>This workspace also includes views of incidents</p>

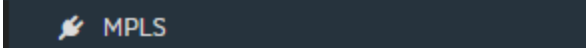
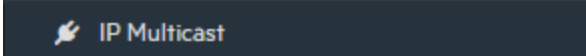
¹Incidents with both: (1) Severity = other than Normal. (2) Correlation Nature = equal to Root Cause, Service Impact, Stream Correlation, Rate Stream Correlation, Info, or None.

Workspaces in NNMi, continued

Workspace Name	Description:
	<p>generated from NNMi Syslog Messages and SNMP Traps.</p> <p>See "Views for Incident Browsing" on page 44 for more information.</p>
	<p>Requires HPE Network Node Manager iSPI Performance for Metrics Software (NNM iSPI Performance for Metrics). To populate performance data in the dashboard views or enhance NNM iSPI Performance for Metrics reports by sharing NNMi configuration settings, install the <i>optional</i> Network Performance Server (NPS) – click here for more information.</p> <p>See also "Views for Performance Analysis" on page 46.</p>
	<p>Requires HPE Network Node Manager iSPI for IP Telephony Software (NNM iSPI for IP Telephony) – click here for more information.</p> <p>See also "Views for Acme IP Telephony" on page 47.</p> <p>See also "Views for Cisco IP Telephony" on page 47.</p> <p>See also "Views for Nortel IP Telephony" on page 48.</p> <p>See also "Views for Avaya IP Telephony" on page 49.</p> <p>See also "Views for Microsoft IP Telephony" on page 50.</p>
	<p>Requires HPE Network Node Manager iSPI for MPLS Software (NNM iSPI for MPLS) – click here for more information.</p> <p>See also "Views for MPLS" on page 51.</p>
	<p>Requires HPE Network Node Manager iSPI for IP Multicast Software (NNM iSPI for IP Multicast) – click here for more information.</p> <p>See also "Views for IP Multicast" on page 52.</p>

Workspaces in NNMi, continued

Workspace Name	Description:
 Quality Assurance	<p>Requires HPE Network Node Manager iSPI Performance for Quality Assurance Software (NNM iSPI Performance for QA) – click here for more information.</p> <p>See also "Views for Quality Assurance" on page 53.</p>
 Traffic Analysis	<p>Requires HPE Network Node Manager iSPI Performance for Traffic Software (NNM iSPI Performance for Traffic) – click here for more information.</p> <p>See also "Views for Traffic Analysis" on page 54.</p>
 Integration Module Configuration	<p>(<i>NNMi Administrators only</i>) Views for Integration Module Configuration are used to configure NNMi for communication with other software products. See Help → Help for Administrators for more information.</p>
 Configuration	<p>(<i>NNMi Administrators only</i>) Views for Configuration are used to specify setting choices for NNMi and the iSPIs. See Help → Help for Administrators for more information.</p>

Related Topics

["Views Available in NNMi" on page 24](#)

Chapter 5: Views Available in NNMi









NNMi offers out-of-the-box views that provide a wealth of information about devices in your network.

Note: You will see some or all of the workspaces and views described, depending on several factors:













- Your assigned NNMi [Security Group Mapping](#).
- The [HPE Network Node Manager i Smart Plug-in software](#) currently installed.
- Your NNMi administrator can integrate other applications into NNMi. Therefore, you might see things that are not described in the NNMi online help. Contact your NNMi administrator if you have questions about any additional items that are not described.

Each view is described in the following topics about each Workspace:

Workspaces in NNMi

 Dashboards	"Views available in the Dashboards Workspace" on the next page
 Incident Management	"Views for Incident Management" on page 30
 Topology Maps	"Views of Topology Maps" on page 31
 Monitoring	"Views for Monitoring Network Devices" on page 38
 Troubleshooting	"Views for Troubleshooting" on page 40
 Inventory	"Views with Inventory Lists" on page 41
 Management Mode	"Views into Management Mode" on page 43
 Incident Browsing	"Views for Incident Browsing" on page 44
 Performance Analysis	"Views for Performance Analysis" on page 46

Workspaces in NNMi, continued

<ul style="list-style-type: none">  Cisco IP Telephony  Acme IP Telephony  Nortel IP Telephony  Avaya IP Telephony  Microsoft IP Telephony 	<p>"Views for Acme IP Telephony" on page 47</p> <p>"Views for Cisco IP Telephony" on page 47</p> <p>"Views for Nortel IP Telephony" on page 48</p> <p>"Views for Avaya IP Telephony" on page 49</p> <p>"Views for Microsoft IP Telephony" on page 50</p>
<ul style="list-style-type: none">  MPLS 	<p>Views for MPLS</p>
<ul style="list-style-type: none">  IP Multicast 	<p>Views for IP Multicast</p>
<ul style="list-style-type: none">  Quality Assurance 	<p>Views for Quality Assurance</p>
<ul style="list-style-type: none">  Traffic Analysis 	<p>"Views for Traffic Analysis" on page 54</p>
<ul style="list-style-type: none">  Integration Module Configuration 	<p>(<i>NNMi Administrators only</i>) Views for  Integration Module Configuration are used to configure NNMi for communication with other software products.</p>
<ul style="list-style-type: none">  Configuration 	<p>(<i>NNMi Administrators only</i>) Views for the  Configuration settings of NNMi and the iSPIs.</p>

Note: Some views appear under folders. To access the list of views available for a folder, click the + (plus sign) that precedes the folder name.

Related Topics

["About Workspaces" on page 19](#)

["Export Table Information" on page 82](#)

Views available in the Dashboards Workspace

The following views are available in the **Dashboards** workspace ("[About Workspaces](#)" on page 19).



















Views available in the **Dashboards** workspace show information pertaining to the entire set of objects managed by NNMi, constrained by the Security Groups to which the logged-in user belongs.

Note: You will see some or all of the workspaces and views described, depending on several factors:

- Your assigned NNMi [Security Group Mapping](#).
- The [HPE Network Node Manager i Smart Plug-in software](#) currently installed.
- Your NNMi administrator can integrate other applications into NNMi. Therefore, you might see things that are not described in the NNMi online help. Contact your NNMi administrator if you have questions about any additional items that are not described.

The following dashboard views are provided by NNMi. Your NNMi administrator can add more:

Network Overview

Panel Title	Description												
Open Key Incidents	<p>Lists the incidents that are most important to network Operators (any Key Incident¹) and that often require more immediate action. The Open Key Incidents view includes those incidents that have a Correlation Nature that is any of the following:</p> <table border="1"> <thead> <tr> <th>Incident Correlation Nature</th> <th>Description</th> </tr> </thead> <tbody> <tr> <td> Info</td> <td>This Correlation Nature is meant to be informational.</td> </tr> <tr> <td> None</td> <td>Indicates there is no incident correlation for this incident.</td> </tr> <tr> <td> Rate Stream Correlation</td> <td>Indicates the incident tracks incident patterns <i>based on the number of incident reoccurrences within a specified time period</i>. After the count within the specified time period is reached, NNMi emits a Rate Correlation incident and continues to update the Correlation Notes with the number of occurrences within that rate.</td> </tr> <tr> <td> Root Cause</td> <td>Indicates an incident that NNMi's Causal Engine determined to be the root cause of a problem.</td> </tr> <tr> <td> User Root Cause</td> <td>Indicates that your NNMi administrator configured NNMi to always treat this Incident as Correlation Nature: Root Cause.</td> </tr> </tbody> </table> <div style="border: 1px solid gray; padding: 10px; margin-top: 10px;"> <p>Note: Key Incidents do not include Incidents with following Correlation Natures because they are not considered to be Key Incidents:</p> <ul style="list-style-type: none">  Dedup Stream Correlation  Secondary Root Cause  Symptom </div>	Incident Correlation Nature	Description	 Info	This Correlation Nature is meant to be informational.	 None	Indicates there is no incident correlation for this incident.	 Rate Stream Correlation	Indicates the incident tracks incident patterns <i>based on the number of incident reoccurrences within a specified time period</i> . After the count within the specified time period is reached, NNMi emits a Rate Correlation incident and continues to update the Correlation Notes with the number of occurrences within that rate.	 Root Cause	Indicates an incident that NNMi's Causal Engine determined to be the root cause of a problem.	 User Root Cause	Indicates that your NNMi administrator configured NNMi to always treat this Incident as Correlation Nature: Root Cause.
Incident Correlation Nature	Description												
 Info	This Correlation Nature is meant to be informational.												
 None	Indicates there is no incident correlation for this incident.												
 Rate Stream Correlation	Indicates the incident tracks incident patterns <i>based on the number of incident reoccurrences within a specified time period</i> . After the count within the specified time period is reached, NNMi emits a Rate Correlation incident and continues to update the Correlation Notes with the number of occurrences within that rate.												
 Root Cause	Indicates an incident that NNMi's Causal Engine determined to be the root cause of a problem.												
 User Root Cause	Indicates that your NNMi administrator configured NNMi to always treat this Incident as Correlation Nature: Root Cause.												
Schedule	The Scheduled Node Outages view in the Management Mode workspace provides a												

¹Incidents with both: (1) Severity = other than Normal. (2) Correlation Nature = equal to Root Cause, Service Impact, Stream Correlation, Rate Stream Correlation, Info, or None.

Network Overview, continued

Panel Title	Description
Outages	record of all past, present, and future Scheduled Node Outages.
Nodes in Infrastructure Node Group	The Networking Infrastructure Device map in the Topology Maps workspace provides representative Node Groups for the Switches and for the Routers in your network.
Nodes in Routers Node Group	The Routers map in the Topology Maps workspace shows a graphical representation of the Layer 3 connectivity in your network. Connector devices on Layer 3 maps are routers, switch-routers, and gateways. (See About Map Symbols for more information.)
Top CPU Utilization (avg)	<p>(<i>NNM iSPI Performance for Metrics</i>) If your NNMI administrator installs and configures thresholds, NNMI provides useful reports here.</p> <p>CPU 5Sec Utilization</p> <p>Threshold based on the percentage of a node's CPU usage compared to the total amount of available CPU capacity. This percentage is the average CPU utilization over the prior 5-seconds.</p> <p>CPU 1Min Utilization</p> <p>Threshold based on the percentage of a node's CPU usage compared to the total amount of available CPU capacity. This percentage is the average CPU utilization over the prior 1-minute.</p> <p>CPU 5Min Utilization</p> <p>Threshold based on the percentage of a node's CPU usage compared to the total amount of available CPU capacity. This percentage is the average CPU utilization over the prior 5-minutes.</p>
Top CPU Utilization (avg)%	<p>(<i>NNM iSPI Performance for Metrics</i>) If your NNMI administrator installs and configures thresholds, NNMI provides useful reports here.</p> <p>CPU 5Sec Utilization</p> <p>Threshold based on the percentage of a node's CPU usage compared to the total amount of available CPU capacity. This percentage is the average CPU utilization over the prior 5-seconds.</p> <p>CPU 1Min Utilization</p> <p>Threshold based on the percentage of a node's CPU usage compared to the total amount of available CPU capacity. This percentage is the average CPU utilization over the prior 1-minute.</p> <p>CPU 5Min Utilization</p> <p>Threshold based on the percentage of a node's CPU usage compared to the total amount of available CPU capacity. This percentage is the average CPU utilization over the prior 5-minutes.</p>
Top Memory Utilization (avg)	(<i>NNM iSPI Performance for Metrics</i>) If your NNMI administrator installs and configures thresholds, NNMI provides useful reports here.

Network Overview, continued

Panel Title	Description
	<p>Memory Utilization</p> <p>Threshold based on the percentage of a node's memory usage compared to the total amount of available memory.</p>
<p>Top Memory Utilization (avg)%</p>	<p>(<i>NNM iSPI Performance for Metrics</i>) If your NNMi administrator installs and configures thresholds, NNMi provides useful reports here.</p> <p>Memory Utilization</p> <p>Threshold based on the percentage of a node's memory usage compared to the total amount of available memory.</p>
<p>Top ICMP Response Time (msec)</p>	<p>(<i>NNM iSPI Performance for Metrics</i>) If your NNMi administrator installs and configures thresholds, NNMi provides useful reports here.</p> <p>Management Address ICMP Response Time</p> <p>Threshold based on elapsed time (in milliseconds) for receiving a node's reply to an Internet Control Message Protocol (ICMP) echo request. The address queried is the node's Management Address attribute value. See the node's Node form, Basic Attributes section for the currently configured address.</p>
<p>Top Interfaces by Volume</p>	<p>(<i>NNM iSPI Performance for Metrics</i>) If your NNMi administrator installs and configures thresholds, NNMi provides useful reports here.</p>
<p>Top Interfaces by Utilization</p>	<p>(<i>NNM iSPI Performance for Metrics</i>) If your NNMi administrator installs and configures thresholds, NNMi provides useful reports here.</p> <p>Input Utilization</p> <p>Threshold based on the percentage of the interface's total incoming octets compared to the maximum number of octets possible (determined by the MIB being used to query <code>ifSpeed</code> of the device and whether the host system supports high-speed counters for interfaces).</p> <div data-bbox="423 1388 1406 1724" style="background-color: #f0f0f0; padding: 10px; margin: 10px 0;"> <p>Tip: Sometimes the <code>ifSpeed</code> value returned by the device's SNMP agent is not accurate and causes problems with thresholds. If your NNMi role allows, you can override the <code>ifSpeed</code> reported by the SNMP agent:</p> <ol style="list-style-type: none"> 1. Open the problem interface's Interface form. 2. Select the General Tab. 3. Locate the Input/Output Speed section. 4. Change the Input Speed or Output Speed setting. </div> <p>Output Utilization</p> <p>Threshold based on the percentage of the interface's total outgoing octets compared to the maximum number of octets possible (determined by the MIB being used to query <code>ifSpeed</code> of the device and whether the host system supports high-speed counters for</p>

Network Overview, continued

Panel Title	Description
	<p>interfaces).</p> <div style="background-color: #f0f0f0; padding: 10px; border: 1px solid #ccc;"> <p>Tip: Sometimes the <code>ifSpeed</code> value returned by the device's SNMP agent is not accurate and causes problems with thresholds. If your NNMi role allows, you can override the <code>ifSpeed</code> reported by the SNMP agent:</p> <ol style="list-style-type: none"> 1. Open the problem interface's Interface form. 2. Select the General Tab. 3. Locate the Input/Output Speed section. 4. Change the Input Speed or Output Speed setting. </div>
<p>Top Interfaces by Discard Rate (avg)</p>	<p>(<i>NNM iSPI Performance for Metrics</i>) If your NNMi administrator installs and configures thresholds, NNMi provides useful reports here.</p> <p>Output Discard Rate</p> <p>Threshold based on the percentage of the interface's discarded output packet count compared to the total number of outgoing packets. Packets might be discarded because of a variety of issues, including transmission buffer overflows, congestion, or system specific issues.</p>
<p>Top Interfaces by Error Rate (avg)</p>	<p>(<i>NNM iSPI Performance for Metrics</i>) If your NNMi administrator installs and configures thresholds, NNMi provides useful reports here.</p> <p>Input Error Rate</p> <p>Threshold based on the percentage of the interface's input packet error count compared to the total number of packets received. What constitutes an error is system specific, but likely includes such issues as bad packet checksums, incorrect header information, and packets that are too small.</p> <p>FCS LAN Error Rate</p> <p><i>Local Area Network interfaces only.</i> Threshold based on the percentage of incoming frames with a bad checksum (CRC¹ value) compared to the total number of incoming frames. Possible causes include collisions at half-duplex, a duplex mismatch, bad hardware (NIC², cable, or port), or a connected device generating frames with bad Frame Check Sequence.</p> <p>FCS WLAN Error Rate</p> <p><i>Wireless Local Area Network Interfaces only.</i> Threshold based on the percentage of incoming frames with a bad checksum (CRC³ value) compared to the total number of incoming frames. Possible causes include wireless communication interference, bad hardware (NIC⁴, cable or port), or a connected device generating frames with bad Frame Check Sequence.</p>

¹Cyclic Redundancy Check
²Network Interface Controller
³Cyclic Redundancy Check
⁴Network Interface Controller

More **Dashboards** views are available when iSPIs are installed. For example:

- Interface Performance and Component Performance dashboards with the NNM iSPI Performance for Metrics

Requires HPE Network Node Manager iSPI Performance for Metrics Software (NNM iSPI Performance for Metrics). To populate performance data in the dashboard views or enhance NNM iSPI Performance for Metrics reports by sharing NNMi configuration settings, install the *optional* Network Performance Server (NPS) – [click here for more information](#).

- QA Performance dashboard with the NNM iSPI Performance for QA

Requires HPE Network Node Manager iSPI Performance for Quality Assurance Software (NNM iSPI Performance for QA) – [click here for more information](#).

For more information about dashboards:







Views for Incident Management

The following views are available in the Incident Management workspace ("[About Workspaces](#)" on page 19).

Note: You will see some or all of the workspaces and views described, depending on several factors:













- Your assigned NNMi [Security Group Mapping](#).
- The [HPE Network Node Manager i Smart Plug-in software](#) currently installed.
- Your NNMi administrator can integrate other applications into NNMi. Therefore, you might see things that are not described in the NNMi online help. Contact your NNMi administrator if you have questions about any additional items that are not described.

Views for Incident Management

View Title	Description						
Open Key Incidents	<p>Lists the incidents that are most important to network Operators (any Key Incident¹) and that often require more immediate action. The Open Key Incidents view includes those incidents that have a Correlation Nature that is any of the following:</p> <table border="1"><thead><tr><th>Incident Correlation Nature</th><th>Description</th></tr></thead><tbody><tr><td> Info</td><td>This Correlation Nature is meant to be informational.</td></tr><tr><td> None</td><td>Indicates there is no incident correlation for this incident.</td></tr></tbody></table>	Incident Correlation Nature	Description	 Info	This Correlation Nature is meant to be informational.	 None	Indicates there is no incident correlation for this incident.
Incident Correlation Nature	Description						
 Info	This Correlation Nature is meant to be informational.						
 None	Indicates there is no incident correlation for this incident.						

¹Incidents with both: (1) Severity = other than Normal. (2) Correlation Nature = equal to Root Cause, Service Impact, Stream Correlation, Rate Stream Correlation, Info, or None.

Views for Incident Management , continued

View Title	Description								
	<table border="1"> <thead> <tr> <th>Incident Correlation Nature</th> <th>Description</th> </tr> </thead> <tbody> <tr> <td> Rate Stream Correlation</td> <td>Indicates the incident tracks incident patterns <i>based on the number of incident reoccurrences within a specified time period</i>. After the count within the specified time period is reached, NNMI emits a Rate Correlation incident and continues to update the Correlation Notes with the number of occurrences within that rate.</td> </tr> <tr> <td> Root Cause</td> <td>Indicates an incident that NNMI's Causal Engine determined to be the root cause of a problem.</td> </tr> <tr> <td> User Root Cause</td> <td>Indicates that your NNMI administrator configured NNMI to always treat this Incident as Correlation Nature: Root Cause.</td> </tr> </tbody> </table> <div style="border: 1px solid #ccc; padding: 10px; margin-top: 10px;"> <p>Note: Key Incidents do not include Incidents with following Correlation Natures because they are not considered to be Key Incidents:</p> <ul style="list-style-type: none">  Dedup Stream Correlation  Secondary Root Cause  Symptom </div>	Incident Correlation Nature	Description	 Rate Stream Correlation	Indicates the incident tracks incident patterns <i>based on the number of incident reoccurrences within a specified time period</i> . After the count within the specified time period is reached, NNMI emits a Rate Correlation incident and continues to update the Correlation Notes with the number of occurrences within that rate.	 Root Cause	Indicates an incident that NNMI's Causal Engine determined to be the root cause of a problem.	 User Root Cause	Indicates that your NNMI administrator configured NNMI to always treat this Incident as Correlation Nature: Root Cause.
Incident Correlation Nature	Description								
 Rate Stream Correlation	Indicates the incident tracks incident patterns <i>based on the number of incident reoccurrences within a specified time period</i> . After the count within the specified time period is reached, NNMI emits a Rate Correlation incident and continues to update the Correlation Notes with the number of occurrences within that rate.								
 Root Cause	Indicates an incident that NNMI's Causal Engine determined to be the root cause of a problem.								
 User Root Cause	Indicates that your NNMI administrator configured NNMI to always treat this Incident as Correlation Nature: Root Cause.								
Unassigned Open Key Incidents	Lists any open Key Incident ¹ that has not yet been assigned. This view is useful for identifying the most recent Key Incidents that must be assigned.								
My Open Incidents	Lists the incidents that have been assigned to the name associated with the current user.								

For more information about workspaces:

Views of Topology Maps

The following views are available in the Topology Maps workspace ("[About Workspaces](#)" on page 19).

Note: You will see some or all of the workspaces and views described, depending on several factors:

¹Incidents with both: (1) Severity = other than Normal. (2) Correlation Nature = equal to Root Cause, Service Impact, Stream Correlation, Rate Stream Correlation, Info, or None.



- Your assigned NNMi [Security Group Mapping](#).
- The [HPE Network Node Manager i Smart Plug-in software](#) currently installed.
- Your NNMi administrator can integrate other applications into NNMi. Therefore, you might see things that are not described in the NNMi online help. Contact your NNMi administrator if you have questions about any additional items that are not described.

(See Help → Help for Operators for more information about Node Group Maps.)

Views of Topology Maps

View Title	Description
Node Group Overview	<p>Displays a map containing all top-level Node Groups. Child groups are not visible until you double-click the parent map link:</p>  <p>(See Help → Help for Operators for more information about Node Group Maps.)</p>
Network Overview (Layer 3)	<p>By default, this map displays a maximum of the 250 most highly connected nodes in the Layer 3 network.</p> <p>The NNMi administrator configures aspects of this map:</p> <ul style="list-style-type: none"> • The maximum number of nodes displayed. If you are an NNMi administrator, for more information, see the "NNMi Console" chapter in the <i>HPE Network Node Manager i Software Deployment Reference</i>, which is available at: http://softwaresupport.hpe.com. • The refresh rate, 5 minutes by default. • The NNMi Console's Initial View is by default this Network Overview. If the the NNMi Administrator wants a different Node Group map to be displayed every time an NNMi user opens NNMi, use the Configuration > User Interface > User Interface Configuration: Initial View settings.
<p>Node Group Maps (Maps that have been saved at some point in time.)</p> <p>Lists the Node Group Maps that your NNMi Administrator saved at some point in time.</p> <p>When using the Node Group Maps folder, note the following:</p> <ul style="list-style-type: none"> • The maps are listed in alphabetical order. 	

Views of Topology Maps , continued

View Title	Description
<ul style="list-style-type: none"> • Each  (tree) represents a Node Group hierarchy, a Node Group that contains other Node Groups. To view the contained Node Groups, click  to expand the folder. • You can perform the actions described in Node Group Map Actions from a Node Group tree. 	
<h3>Node Group Map Actions</h3>	
Task	Action
Display a Node Group map	Click the Node Name
Display the Node Group Map Settings form for the selected Node Group	<p>Right-click the Node Name and select Open Node Group Map Settings</p> <p>This action appears only if you have permission to edit Node Group maps for the nodes you have permission to access. If you are an Network Node Manager i Software administrator, see the "Maintaining NNMI" chapter chapter of the HPE Network Node Manager i Software Deployment Reference for information about how to enable access to this action.</p>
Display the Node Group form for the selected Node Group	Right-click the Node Name and select Open Node Group
<p>Note: These Node Group maps include the Node Group maps provided by NNMI as well as the custom Node Group maps that were created using the Node Group Map Settings option. If you are an Network Node Manager i Software administrator, see Define Node Group Map Settings for more information about configuring Node Group Map Settings.</p>	
<h3>Node Group Maps (default list)</h3>	
View Titles	Description
Networking Infrastructure Devices	<p>Displays representative Node Groups for the Switches and for the Routers in your network. Each of the following device types, if applicable, are also included on the map:</p> <ul style="list-style-type: none"> • Chassis

Views of Topology Maps , continued

View Title	Description
Node Group Maps (default list), continued	
View Titles	Description
	<ul style="list-style-type: none"> • Firewalls • Voice Gateways <p>Note: Your NNMi Administrator can remove this map from the Topology Maps workspace.</p> <p>See Help → Help for Operators for more information about Node Group Maps.</p>
And additional views . . .	Any additional Node Group maps that your NNMi Administrator configured and saved at some point in time.

Quick Access Maps (Maps that have an assigned Ordering Number.)

When the NNMi Administrator assigns a Topology Maps Ordering number to the Node Group's map (Configuration > User Interface > Node Group Map Settings):

- The link to that Node Group's map automatically shows up under the Topology Maps > Quick Access Maps folder in the assigned order.

The Quick Access Maps folder is visible to all NNMi users.

Quick Access Maps (default list)

View Titles	Description
Networking Infrastructure Devices	<p>This map appears under the Node Group Maps and Quick Access Maps folders.</p> <p>Displays representative Node Groups for the Switches and for the Routers in your network. Each of the following device types, if applicable, are also included on the map:</p> <ul style="list-style-type: none"> • Chassis • Firewalls • Voice Gateways <p>Note: Your NNMi Administrator can remove this map from the Topology Maps workspace.</p>

Views of Topology Maps , continued

View Title	Description
Quick Access Maps (default list), continued	
View Titles	Description
	See Help → Help for Operators for more information about Node Group Maps.
Routers	<p>This map appears under the Node Group Maps and Quick Access Maps folders. Displays a Node Group Map of the Router and Layer 3 connectivity in your network.</p> <p>Tip: See "About Node and Interface Groups" on page 70 for more information about Node Groups.</p> <p>Note: If the number of Node Groups in your network is greater than the maximum number of map objects configured to be displayed on the map, NNMi filters the map to display routers that have interfaces with addresses in the largest number of overall subnets in the network.</p> <p>Your NNMi administrator can configure the maximum number of nodes to be displayed on a map. See "Help for Administrators" for more information.</p> <p>Note: Your NNMi Administrator can remove this map from the Topology Maps workspace.</p>
Switches	<p>This map appears under the Node Group Maps and Quick Access Maps folders. Displays a Node Group map of the Switches and Layer 2 connectivity in your network.</p> <p>Tip: See "About Node and Interface Groups" on page 70 for more information about Node Groups.</p> <p>Note: If the number of nodes in your network is greater than the maximum number of nodes configured to be displayed on the map, NNMi filters the map to display switches that are the most highly connected.</p> <p>Your NNMi administrator can configure the maximum number of nodes to be displayed on a map. See "Help for Administrators" for more information.</p>

Views of Topology Maps , continued

View Title	Description
Quick Access Maps (default list), continued	
View Titles	Description
	Note: Your NNMi Administrator can remove this map from the Topology Maps workspace.
And additional views . . .	Any additional Node Group maps that your NNMi Administrator configured, saved, and assigned an ordering number at some point in time.

[All Node Groups](#) (Links to all defined Node Groups. Visible only to NNMi Administrators.)

When NNMi Administrators create a Node Group:

- The link to that Node Group's map automatically shows up under the Topology Maps workspace in the All Node Groups folder in alphabetical order.
- The Node Group Map icon is initially grey (🗑️).
- When the map is saved at some point in time, the icon changes to multi-colored (🌈) and the link to that map is added to the Node Group Maps folder where other NNMi users can see it.
- When an ordering number is assigned to a Node Group Map, that map is added to the Quick Access Maps folder where other NNMi users can see it.

When using the **All Node Groups** folder, note the following:

- If you are an Network Node Manager i Software Administrator, see [Define Node Group Map Settings](#) for more information about configuring Node Group Map Settings.
- This folder appears only if you have permission to create and delete Node Groups for the nodes you have permission to access. If you are an Network Node Manager i Software Administrator, see the "Maintaining NNMi" chapter of the HPE Network Node Manager i Software Deployment Reference for information about how to enable access to this folder.
- Each + (tree) represents a Node Group hierarchy, a Node Group that contains other Node Groups. To view the contained Node Groups, click ▶ to expand the folder.
- You can perform the actions described in [Node Group Map Actions](#) from a Node Group tree:

Node Group Map Actions

Task	Action
Display a Node Group map	Click the Node Name
Display the Node Group Map Settings form for the	Right-click the Node Name and select Open Node Group Map Settings This action appears only if you have permission to edit Node Group Maps for the nodes you have permission to access. If you are an Network Node Manager i

Views of Topology Maps , continued

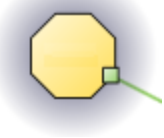
View Title	Description
Node Group Map Actions, continued	
Task	Action
selected Node Group	Software administrator, see the "Maintaining NNMi" chapter chapter of the HPE Network Node Manager i Software Deployment Reference for information about how to enable access to this action.
Display the Node Group form for the selected Node Group	Right-click the Node Name and select Open Node Group
All Node Group Maps (default list)	
View Titles	Description
Important Nodes	Any devices in this group receive special treatment. When a current member of this group stops responding, the Causal Engine generates a "Node Down" incident and sets the device status to Critical.
Microsoft Windows Systems	This Node Group automatically includes any device manufactured by Microsoft.
Neighbor Connections Filter	<p>Your NNMi administrator can configure a Node Group map to show devices that are connected to Node Group members (one-hop neighbors), but not themselves a member.</p> <p>A gray halo around the map icon indicates a one-hop neighbor:</p>  <p>Not all one-hop neighbors are shown. Your NNMi administrator chooses a particular Node Group as the Neighbor Connections Filter. Only one-hop devices within the specified Node Group are displayed.</p>
Networking Infrastructure Devices	This Node Group includes any Routers or Switches within your management domain. They are monitored with special attention against fault metrics.

Views of Topology Maps , continued

View Title	Description
All Node Group Maps (default list), continued	
View Titles	Description
Non-SNMP Devices	This Node Group includes any device that does not respond to SNMP.
Virtual Machines	(<i>NNMi Advanced</i>) This Node Group includes any virtual machine ¹ being hosted on a hypervisor ² .
VMware ESX Hosts	(<i>NNMi Advanced</i>) This Node Group includes any VMware ESXi server that is hosting virtual machines.
And additional views . . .	Any additional Node Groups that the NNMi Administrator defined.

For more information about workspaces:

Views for Monitoring Network Devices

The following views are available in the Monitoring workspace ("[About Workspaces](#)" on page 19).

Note: You will see some or all of the workspaces and views described, depending on several factors:

- Your assigned NNMi [Security Group Mapping](#).
- The [HPE Network Node Manager i Smart Plug-in software](#) currently installed.
- Your NNMi administrator can integrate other applications into NNMi. Therefore, you might see things that are not described in the NNMi online help. Contact your NNMi administrator if you have questions about any additional items that are not described.

(See Help → Help for Operators for more information about Node Group Maps.)

Views to Assist You with Monitoring Network Devices

View Title	Description
Non-Normal Node Sensors	(<i>NNM iSPI Performance for Metrics</i>) Lists nodes that might need operator attention due to a problem with the Node's buffers, CPU, disk, Memory, etc.

¹A device that utilizes components from multiple physical devices. Depending on the manufacturer's implementation, the virtual machine may be static or dynamic.

²The virtual machine manager in charge of delegating various aspects from a pool of resources to become virtual devices. The delegations might be static or dynamic, depending on the manufacturer's implementation. The type of virtual machines being generated depends on the manufacturer's implementation.

Views to Assist You with Monitoring Network Devices , continued

View Title	Description
Non-Normal Physical Sensors	Lists chassis or cards that might need operator attention due to a problem with the chassis's such as backplane, fan, power supply, temperature, and voltage.
Non-Normal Chassis	Lists Chassis that might need operator attention due to a problem with the health objects within the chassis.
Non-Normal Cards	Lists cards that might need operator attention.
Non-Normal Interfaces	Lists interfaces that might need operator attention.
Non-Normal Nodes	Lists nodes that might need operator attention.
Non-Normal SNMP Agents	Lists SNMP Agents that have a state other than Normal.
Not Responding Addresses	Lists addresses that have a state of Not Responding. A Not Responding state indicates that the address is not responding to ICMP ping.
Interface Performance	<i>(NNM iSPI Performance for Metrics)</i> Helps you identify the over-used and under-used interfaces for the nodes in your managed network.
Chassis Redundancy Groups	Lists the Chassis Redundancy Groups that NNMi discovered. See Help → Help for Operators for more information about Chassis Redundancy Groups.
Card Redundancy Groups	Lists the Card Redundancy Groups that NNMi discovered. See Help → Help for Operators for more information about Card Redundancy Groups.
Router Redundancy Groups	Lists the available Router Redundancy Groups created by the NNMi administrator. Each Router Redundancy Group is a set of two or more routers that use one or more virtual IP addresses to help ensure that information packets reach their intended destination. See Help → Help for Operators for more information about Router Redundancy Groups.
Node Groups	Lists the Node Groups created by the NNMi administrator. Node Groups enable the NNMi administrator to define groups of nodes based on several criteria, including by host name or location. See "About Node and Interface Groups" on page 70 for more information about Node Groups.
Custom Node Collections	Lists the Custom Node Collections that have been created using NNMi's Custom Poller. A Custom Node Collection identifies a topology node that has at least one associated Custom Poller Policy.

Views to Assist You with Monitoring Network Devices , continued

View Title	Description
	See Help → Help for Operators for more information about Custom Node Collections.
Custom Polled Instances	Lists the Custom Polled Instances that have been created using NNMI's Custom Poller. NNMI creates Custom Polled Instances the first time a MIB Expression is validated with discovery information. See Help → Help for Operators for more information about Custom Polled Instances.

For more information about workspaces:

Views for Troubleshooting

The following views are available in the Troubleshooting workspace ("[About Workspaces](#)" on page 19).

Note: You will see some or all of the workspaces and views described, depending on several factors:

- Your assigned NNMI [Security Group Mapping](#).
- The [HPE Network Node Manager i Smart Plug-in software](#) currently installed.
- Your NNMI administrator can integrate other applications into NNMI. Therefore, you might see things that are not described in the NNMI online help. Contact your NNMI administrator if you have questions about any additional items that are not described.

(See Help → Help for Operators for more information about Node Group Maps.)

Views to Assist You with Troubleshooting

View Title	Description
Layer 2 Neighbor View	Displays a map view of a selected device and its connector devices within a specified number of hops from the selected device. This view is useful for understanding the switch connectivity between devices. The background color of a node in a network map indicates the node's or interface's status. For example, green indicates the node is up. Red indicates the node or interface is down.
Layer 3 Neighbor View	Displays a map view of a selected device and its connector devices within a specified number of hops from the selected device. This view is useful for understanding the router connectivity between devices. The background color of a node in a network map indicates the node's or interface's status. For example, green indicates the node is up. Red indicates the node or interface is down.
Path View	Displays an active network path between a source and destination end point. Caution: Do not specify a switch as a Source or Destination node in Path View maps. To view connectivity between switches, use the Layer 2 Neighbor View.

Views to Assist You with Troubleshooting , continued

View Title	Description
	<p>This view is useful for diagnosing connectivity problems; for example, when one node cannot communicate with another or when you are not able to access a particular node, such as a client PC not being able to contact the Microsoft Exchange server.</p> <p>Note: (NNMi Advanced) Path View works only with IPv4 addresses. The NNMi Advanced IPv6 address values are not valid choices for Path View. Any devices in your network that are configured with IPv6 addresses cannot be displayed on Path View maps.</p>
Node Group Map	<p>Displays the pre-defined members of a Node Group in the context of not only status and connectivity, but of a pre-defined background image (for example, a map of North America).</p> <p>See Help Help for Operators for more information about Node Group Maps.</p>

For more information about workspaces:

Views with Inventory Lists

The following views are available in the Inventory workspace ("[About Workspaces](#)" on page 19).

Note: You will see some or all of the workspaces and views described, depending on several factors:

- Your assigned NNMi [Security Group Mapping](#).
- The [HPE Network Node Manager i Smart Plug-in software](#) currently installed.
- Your NNMi administrator can integrate other applications into NNMi. Therefore, you might see things that are not described in the NNMi online help. Contact your NNMi administrator if you have questions about any additional items that are not described.

Views with Inventory Lists

View Title	Description
Nodes	<p>Lists the status for all nodes discovered by NNMi.</p> <p>Sorting this view by status lets you see all of the nodes that are down or somehow disabled.</p>
Interfaces	<p>Lists the information about all network interfaces discovered by NNMi.</p> <p>Sorting this view by associated node Name value (Hosted on Node) lets you see all of the network interfaces per node.</p> <p>Sorting the view by Administrative or Operations Status helps you determine the interfaces or nodes that are down or somehow disabled.</p>
IP Addresses	<p>Lists the status for all IP addresses hosted on Nodes that are discovered by NNMi. (The Node form: IP Addresses tab also displays relevant addresses from this view.)</p>

Views with Inventory Lists , continued

View Title	Description
SNMP Agents	List the status for each SNMP Agent that is enabled
IP Subnets	Lists the status for all IP subnets. Sorting this view by status lets you quickly see all of the IP addresses that have a status that indicates there is a current or potential problem.
VLANs	Lists the switch port VLANs discovered in your network environment. A device can participate in multiple VLANs. And a port can be assigned to multiple VLANs.
Chassis	Lists the chassis NNMi discovered in your network environment.
Cards	Lists the cards NNMi discovered in your network environment.
Ports	Lists the ports NNMi discovered in your network environment.
Node Sensors	(<i>NNMi SPI Performance for Metrics</i>) Lists information about aspects of nodes such as buffers, CPU, disks, and memory.
Physical Sensors	Lists aspects of chassis such as backplanes, fans, power supplies, temperature, and voltage.
Layer 2 Connections	Lists the Layer 2 connections discovered or added in your network environment.
Nodes (All Attributes)	Provides a Node view of most Node attributes. Sort and filter this view to meet your needs.
Interfaces (All Attributes)	Provides an Interface view of most Interface attributes. Sort and filter this view to meet your needs.
IP Addresses (All Attributes)	Provides an IP Address view of most IP Address attributes. Sort and filter this view to meet your needs. One column shows any currently configured Mapped Addresses. If <i>static</i> Network Address Translation (NAT) is part of your network, your NNMi administrator can configure NNMi to display the NAT <i>internal IP address</i> assigned (mapped) to the selected <i>external IP address</i> .
MIB Variables	Lists the MIB variables available from the MIBs that are loaded in the NNMi database.
Chassis Redundancy Groups	Lists the Chassis Redundancy Groups that NNMi discovered. See Help → Help for Operators for more information about Chassis Redundancy Groups.
Card Redundancy Groups	Lists the Card Redundancy Groups that NNMi discovered. See Help → Help for Operators for more information about Card Redundancy Groups.
Router Redundancy Groups	(<i>NNMi Advanced</i>) Lists the available Router Redundancy Groups created by the NNMi administrator. Each Router Redundancy Group is a set of two or more routers that use one or more protected (virtual) IP addresses to help ensure that information packets reach their

Views with Inventory Lists , continued

View Title	Description
	intended destination. See Help → Help for Operators for more information about Router Redundancy Groups.
Router Redundancy Members	(<i>NNMi Advanced</i>) Lists the members of the Router Redundancy Groups created by the NNMi administrator.
Node Groups	Lists the Node Groups provided by NNMi and created by the NNMi administrator. See " About Node and Interface Groups " on page 70 for more information about Node Groups.
Interface Groups	Lists the Interface Groups provided by NNMi and created by the NNMi administrator. See Help → Help for Operators for more information about Interface Groups.
MPLS WAN Clouds (RAMS)	(<i>NNMi Advanced, plus HPE Route Analytics Management System (RAMS) for MPLS WAN</i>) Shows the information about all MPLS WANs discovered by NNMi.

For more information about workspaces:







Views into Management Mode

The following views are available in the Management Mode workspace ("[About Workspaces](#)" on page 19).











Note: You will see some or all of the workspaces and views described, depending on several factors:

- Your assigned NNMi [Security Group Mapping](#).
- The [HPE Network Node Manager i Smart Plug-in software](#) currently installed.
- Your NNMi administrator can integrate other applications into NNMi. Therefore, you might see things that are not described in the NNMi online help. Contact your NNMi administrator if you have questions about any additional items that are not described.

Management Mode Views

View Title	Description
Unmanaged Nodes	Lists all of the nodes that have a management mode set to  Not Managed or  Out of Service . These nodes are no longer being monitored nor updated.
Unmanaged Interfaces	Lists all of the interfaces that have a management mode set to  Not Managed or  Out of Service . These interfaces are no longer being monitored nor updated.
Unmanaged IP Addresses	Lists all of the addresses that have a management mode set to  Not Managed or  Out of Service . These addresses are no longer being monitored nor updated.

Management Mode Views , continued

View Title	Description
Unmanaged Chassis	Lists all of the chassis that have a management mode set to  Not Managed or  Out of Service . These chassis are no longer being monitored nor updated.
Unmanaged Cards	Lists all of the cards that have a management mode set to  Not Managed or  Out of Service . These cards are no longer being monitored nor updated.
Unmanaged Node Sensors	<i>(NNM iSPI Performance for Metrics)</i> Lists all of the node sensors that have a management mode set to  Not Managed or  Out of Service . These node sensors are no longer being monitored nor updated.
Unmanaged Physical Sensors	Lists all of the physical sensors that have a management mode set to  Not Managed or  Out of Service . These physical sensors are no longer being monitored nor updated.
Scheduled Node Outages	Lists all past, present, and future Scheduled Node Outages. During the Scheduled Outage time period, NNMI suspends any Discovery and Monitoring of that Node and changes the following: <ul style="list-style-type: none">• Node Status =  No Status• Node Management Mode =  Out of Service When the specified time period ends, NNMI gathers current information and updates the Node data.

For more information about workspaces:



















Views for Incident Browsing

The following views are available in the Incident Browsing workspace ("[About Workspaces](#)" on page 19).

Note: You will see some or all of the workspaces and views described, depending on several factors:

- Your assigned NNMI [Security Group Mapping](#).
- The [HPE Network Node Manager i Smart Plug-in software](#) currently installed.
- Your NNMI administrator can integrate other applications into NNMI. Therefore, you might see things that are not described in the NNMI online help. Contact your NNMI administrator if you have questions about any additional items that are not described.

Views for Incident Browsing

View Title	Description												
Open Key Incidents	<p>Shows the incidents that are most important to network Operators (any Key Incident¹) and that often require more immediate action. The Open Key Incidents view includes those incidents that have a Correlation Nature that is any of the following:</p> <table border="1"> <thead> <tr> <th>Incident Correlation Nature</th> <th>Description</th> </tr> </thead> <tbody> <tr> <td> Info</td> <td>This Correlation Nature is meant to be informational.</td> </tr> <tr> <td> None</td> <td>Indicates there is no incident correlation for this incident.</td> </tr> <tr> <td> Rate Stream Correlation</td> <td>Indicates the incident tracks incident patterns <i>based on the number of incident reoccurrences within a specified time period</i>. After the count within the specified time period is reached, NNMi emits a Rate Correlation incident and continues to update the Correlation Notes with the number of occurrences within that rate.</td> </tr> <tr> <td> Root Cause</td> <td>Indicates an incident that NNMi's Causal Engine determined to be the root cause of a problem.</td> </tr> <tr> <td> User Root Cause</td> <td>Indicates that your NNMi administrator configured NNMi to always treat this Incident as Correlation Nature: Root Cause.</td> </tr> </tbody> </table> <p>Note: Key Incidents do not include Incidents with following Correlation Natures because they are not considered to be Key Incidents:</p> <ul style="list-style-type: none">  Dedup Stream Correlation  Secondary Root Cause  Symptom 	Incident Correlation Nature	Description	 Info	This Correlation Nature is meant to be informational.	 None	Indicates there is no incident correlation for this incident.	 Rate Stream Correlation	Indicates the incident tracks incident patterns <i>based on the number of incident reoccurrences within a specified time period</i> . After the count within the specified time period is reached, NNMi emits a Rate Correlation incident and continues to update the Correlation Notes with the number of occurrences within that rate.	 Root Cause	Indicates an incident that NNMi's Causal Engine determined to be the root cause of a problem.	 User Root Cause	Indicates that your NNMi administrator configured NNMi to always treat this Incident as Correlation Nature: Root Cause.
Incident Correlation Nature	Description												
 Info	This Correlation Nature is meant to be informational.												
 None	Indicates there is no incident correlation for this incident.												
 Rate Stream Correlation	Indicates the incident tracks incident patterns <i>based on the number of incident reoccurrences within a specified time period</i> . After the count within the specified time period is reached, NNMi emits a Rate Correlation incident and continues to update the Correlation Notes with the number of occurrences within that rate.												
 Root Cause	Indicates an incident that NNMi's Causal Engine determined to be the root cause of a problem.												
 User Root Cause	Indicates that your NNMi administrator configured NNMi to always treat this Incident as Correlation Nature: Root Cause.												
Closed Key Incidents	Shows the key incidents that have been closed. This view is useful for identifying the root cause incidents that have been resolved. This view might be particularly useful for reporting on how many incidents were closed within a given time period.												
Open Root Cause Incidents	Shows the root cause incidents that have not yet been closed. This view is useful for identifying the root cause incidents that need to be resolved.												
Service Impact Incidents	Indicates incidents that have a relationship to other incidents in which a network service is affected. For example, an Interface Down incident can effect a Router Redundancy Group that is part of an HSRP service. The Service Impact incident helps to identify the service												

¹Incidents with both: (1) Severity = other than Normal. (2) Correlation Nature = equal to Root Cause, Service Impact, Stream Correlation, Rate Stream Correlation, Info, or None.

Views for Incident Browsing , continued

View Title	Description
	that is affected. This Correlation Nature is available for use by HPE Network Node Manager i Software Smart Plug-ins (iSPIs). See Help → Help for Administrators for more information about NNM iSPIs.
All Incidents	Shows all incidents. This view is useful for determining all of the incidents that have been generated within a certain time period.
Custom Open Incidents	Enables you to choose the columns of incident information for all Open incidents, to better meet your needs. For example, you might want to filter the view to display only the incidents related to a particular set of devices. You might also want to filter the view to display only the incidents assigned to you.
Custom Incidents	Lets you create a customized view for your incident information. For example, you might want to filter this view to include only the incidents assigned to you.
Syslog Messages	(<i>HPE ArcSight</i>) The HPE NNMi–ArcSight integration adds syslog message information to NNMi so that you can view these syslog messages and investigate potential problems.
SNMP Traps	Lists all of the traps that were received from devices in your network environment. Your NNMi administrator must configure specific traps before they are displayed within NNMi incident views.

For more information about workspaces:

Views for Performance Analysis

Requires HPE Network Node Manager iSPI Performance for Metrics Software (NNM iSPI Performance for Metrics). To populate performance data in the dashboard views or enhance NNM iSPI Performance for Metrics reports by sharing NNMi configuration settings, install the *optional* Network Performance Server (NPS) – [click here for more information](#).

The following views are available in the Performance Analysis workspace.

Note: You will see some or all of the workspaces and views described, depending on several factors:

- Your assigned NNMi [Security Group Mapping](#).
- The [HPE Network Node Manager i Smart Plug-in software](#) currently installed.
- Your NNMi administrator can integrate other applications into NNMi. Therefore, you might see things that are not described in the NNMi online help. Contact your NNMi administrator if you have questions about any additional items that are not described.

Views for Performance Analysis

View Title	Description
Node Performance Metrics	Lists the statuses of nodes on which performance monitoring is configured.
Interface Performance Metrics	Lists the statuses of interfaces on which performance monitoring is configured.

For more information about workspaces:

Views for Acme IP Telephony

Requires HPE Network Node Manager iSPI for IP Telephony Software (NNM iSPI for IP Telephony) -- [click here for more information](#).

The following views are available in the Acme IP Telephony workspace. You can view this workspace only after installing the NNM iSPI for IP Telephony.

To check that the NNM iSPI for IP Telephony is installed:

1. Select the **Help** → **System Information** in the menu toolbar.
2. In the System Information popup, go to the Extensions tab. If you can see iSPI for IP Telephony under the HP NNM iSPI Software Deployed section, the NNM iSPI for IP Telephony is installed.

Click **Help** → **Help for NNM iSPIs** → **IP Telephony Online Help** for an explanation about these views added by the NNM iSPI for IP Telephony.

Note: You will see some or all of the workspaces and views described, depending on several factors:

- Your assigned NNMI [Security Group Mapping](#).
- The [HPE Network Node Manager i Smart Plug-in software](#) currently installed.
- Your NNMI administrator can integrate other applications into NNMI. Therefore, you might see things that are not described in the NNMI online help. Contact your NNMI administrator if you have questions about any additional items that are not described.

Views for Acme IP Telephony

View Title	Description
Session Director	Lists the Acme Session Directors that are discovered and monitored in your environment.

For more information about workspaces:

Views for Cisco IP Telephony

Requires HPE Network Node Manager iSPI for IP Telephony Software (NNM iSPI for IP Telephony) --

[click here for more information.](#)

The following views are available in the Cisco IP Telephony workspace. You can view this workspace only after installing the NNM iSPI for IP Telephony.

To check that the NNM iSPI for IP Telephony is installed:

1. Select the **Help** → **System Information** in the menu toolbar.
2. In the System Information popup, go to the Extensions tab. If you can see iSPI for IP Telephony under the HP NNM iSPI Software Deployed section, the NNM iSPI for IP Telephony is installed.

Click **Help** → **Help for NNM iSPIs** → **IP Telephony Online Help** for an explanation about these views added by the NNM iSPI for IP Telephony.

Note: You will see some or all of the workspaces and views described, depending on several factors:

- Your assigned NNMI [Security Group Mapping](#).
- The [HPE Network Node Manager i Smart Plug-in software](#) currently installed.
- Your NNMI administrator can integrate other applications into NNMI. Therefore, you might see things that are not described in the NNMI online help. Contact your NNMI administrator if you have questions about any additional items that are not described.

Views for Cisco IP Telephony

View Title	Description
UCM Clusters	Lists the Cisco Unified Communications Manager clusters discovered on the network.
UCMEs	Lists the available Unified Call Manager Expresses (UCMEs) on the network.
IP Phones	Lists the discovered Cisco IP phones on the network.
Gatekeepers	Lists the discovered Cisco gatekeeper devices on the network.
Unity Devices	Lists the discovered Cisco unity devices on the network.

For more information about workspaces:

Views for Nortel IP Telephony

Requires HPE Network Node Manager iSPI for IP Telephony Software (NNM iSPI for IP Telephony) – [click here for more information.](#)

The following views are available in the Nortel IP Telephony workspace. You can view this workspace only after installing the NNM iSPI for IP Telephony.

To check that the NNM iSPI for IP Telephony is installed:

1. Select the **Help** → **System Information** in the menu toolbar.
2. In the System Information popup, go to the Extensions tab. If you can see iSPI for IP Telephony under the HP NNM iSPI Software Deployed section, the NNM iSPI for IP Telephony is installed.

Click **Help** → **Help for NNM iSPIs** → **IP Telephony Online Help** for an explanation about these views added by the NNM iSPI for IP Telephony.

Note: You will see some or all of the workspaces and views described, depending on several factors:

- Your assigned NNMi [Security Group Mapping](#).
- The [HPE Network Node Manager i Smart Plug-in software](#) currently installed.
- Your NNMi administrator can integrate other applications into NNMi. Therefore, you might see things that are not described in the NNMi online help. Contact your NNMi administrator if you have questions about any additional items that are not described.

Views for Nortel IP Telephony

View Title	Description
Call Servers	Lists the Nortel Call Servers discovered on the network.
Signaling Servers	Lists the Nortel Signaling Servers discovered on the network.
IP Phones	Lists the Nortel IP phones discovered on the network.
Media Gateways	Lists the Nortel Media Gateways discovered on the network.

For more information about workspaces:

Views for Avaya IP Telephony

Requires HPE Network Node Manager iSPI for IP Telephony Software (NNM iSPI for IP Telephony) – [click here for more information](#).

The following views are available in the Avaya IP Telephony workspace. You can view this workspace only after installing the NNM iSPI for IP Telephony.

To check that the NNM iSPI for IP Telephony is installed:

1. Select the **Help** → **System Information** in the menu toolbar.
2. In the System Information popup, go to the Extensions tab. If you can see iSPI for IP Telephony under the HP NNM iSPI Software Deployed section, the NNM iSPI for IP Telephony is installed.

Click **Help** → **Help for NNM iSPIs** → **IP Telephony Online Help** for an explanation about these views added by the NNM iSPI for IP Telephony.

Note: You will see some or all of the workspaces and views described, depending on several factors:

- Your assigned NNMi [Security Group Mapping](#).
- The [HPE Network Node Manager i Smart Plug-in software](#) currently installed.
- Your NNMi administrator can integrate other applications into NNMi. Therefore, you might see things that are not described in the NNMi online help. Contact your NNMi administrator if you have questions about any additional items that are not described.

Views for Avaya IP Telephony

View Title	Description
Call Controllers	Lists the Avaya Call Controllers discovered on the network.
IP Phones	Lists the Avaya IP phones discovered on the network.
Media Gateways	Lists the Avaya Media Gateways discovered on the network.

For more information about workspaces:

Views for Microsoft IP Telephony

Requires HPE Network Node Manager iSPI for IP Telephony Software (NNM iSPI for IP Telephony) -- [click here for more information](#).

The following views are available in the Microsoft IP Telephony workspace. You can view this workspace only after installing the NNM iSPI for IP Telephony.

To check that the NNM iSPI for IP Telephony is installed:

1. Select the **Help** → **System Information** in the menu toolbar.
2. In the System Information popup, go to the Extensions tab. If you can see iSPI for IP Telephony under the HP NNM iSPI Software Deployed section, the NNM iSPI for IP Telephony is installed.

Click **Help** → **Help for NNM iSPIs** → **IP Telephony Online Help** for an explanation about these views added by the NNM iSPI for IP Telephony.

Note: You will see some or all of the workspaces and views described, depending on several factors:

- Your assigned NNMi [Security Group Mapping](#).
- The [HPE Network Node Manager i Smart Plug-in software](#) currently installed.
- Your NNMi administrator can integrate other applications into NNMi. Therefore, you might see things that are not described in the NNMi online help. Contact your NNMi administrator if you have questions about any additional items that are not described.

Views for Microsoft IP Telephony

View Title	Description
Lync Sites	Lists the Lync sites discovered on the network.
Servers	Lists the servers discovered from all the server pools associated with the Lync server on the network.
Gateways	Lists the gateways discovered on the network.
Lync End Users	Lists the end users discovered on the network for the Lync Server.
End User Groups	Lists the end user groups discovered on the network for the Lync Server.

Views for Microsoft IP Telephony, continued

View Title	Description
Sites	Lists the sites defined by the iSPI administrator.
SIP Trunk Configurations	Lists the SIP trunks discovered on the network.
Dial Plans	Lists the dial plans discovered on the network.
Voice Routes	Lists the voice routes discovered on the network.
Voice Policies	Lists the voice policies discovered on the network.

For more information about workspaces:

Views for MPLS

Requires HPE Network Node Manager iSPI for MPLS Software (NNM iSPI for MPLS) -- [click here for more information](#).

If you are on a service provider's team, the NNM iSPI for MPLS helps your team ensure that customer obligations are met. The following views are available in the MPLS workspace. You can view this workspace only after installing the NNM iSPI for MPLS.

To check that the NNM iSPI for MPLS is installed:

1. Select the **Help** → **System Information** in the menu toolbar.
2. In the System Information popup, go to the Extensions tab. If you can see iSPI for MPLS under the HPE NNM iSPI Software Deployed section, the NNM iSPI for MPLS is installed.

Click **Help** → **Help for NNM iSPIs** → **iSPI for MPLS Help** for an explanation about these views added by the NNM iSPI for MPLS.

Note: You will see some or all of the workspaces and views described, depending on several factors:

- Your assigned NNMI [Security Group Mapping](#).
- The [HPE Network Node Manager i Smart Plug-in software](#) currently installed.
- Your NNMI administrator can integrate other applications into NNMI. Therefore, you might see things that are not described in the NNMI online help. Contact your NNMI administrator if you have questions about any additional items that are not described.

Views for MPLS

View Title	Description
LSR Inventory	Lists all the MPLS-enabled routers managed by the NNM iSPI for MPLS.
L3 VPN Inventory	Lists all available Level 3 (L3) virtual private network (VPNs) on the network.

Views for MPLS, continued

View Title	Description
MVPN Inventory	Lists all available multicast virtual private networks (MVPNs) on the network.
VPLS VPN Inventory	Lists all available Virtual Private LAN Service (VPLS) virtual private networks (VPNs) on the network.
VPWS VPN Inventory	Lists all available Virtual Private Wire Service (VPWS) virtual private networks (VPNs) on the network.
Pseudowire VC Inventory	Lists all available Pseudowire Virtual Circuits (VCs) on the network.
TE Tunnel Inventory	Lists all available Traffic Engineering (TE) tunnels on the network.
Monitored LSP Inventory	Lists all monitored MPLS Label Switched Paths (LSPs) on the network.
SDP Inventory	Lists all available telecommunications service delivery platforms (SDPs) on the network.

For more information about workspaces:

Views for IP Multicast

Requires HPE Network Node Manager iSPI for IP Multicast Software (NNM iSPI for IP Multicast) – [click here for more information](#).

The following views are available in the IP Multicast workspace. You can view this workspace only after installing the NNM iSPI for IP Multicast.

To check that the NNM iSPI for IP Multicast is installed:

1. Select the **Help** → **System Information** in the menu toolbar.
2. In the System Information popup, go to the Extensions tab. If you can see IP Multicast SPI under the HPE NNM iSPI Software Deployed section, the NNM iSPI for IP Multicast is installed.

Click **Help** → **Help for NNM iSPIs** → **iSPI for IP Multicast Help** for an explanation about these views added by the NNM iSPI for IP Multicast.

Note: You will see some or all of the workspaces and views described, depending on several factors:

- Your assigned NNMi [Security Group Mapping](#).
- The [HPE Network Node Manager i Smart Plug-in software](#) currently installed.
- Your NNMi administrator can integrate other applications into NNMi. Therefore, you might see things that are not described in the NNMi online help. Contact your NNMi administrator if you have questions about any additional items that are not described.

Views for IP Multicast

View Title	Description
IP Multicast Nodes	Lists multicast-enabled nodes on the network.
IP Multicast Interfaces	Lists PIM interfaces on the network.
IP Multicast Flows	Lists multicast traffic flows on the network.

For more information about workspaces:

Views for Quality Assurance

Requires HPE Network Node Manager iSPI Performance for Quality Assurance Software (NNM iSPI Performance for QA) – [click here for more information](#).

The following views are available in the Quality Assurance workspace. You can view this workspace only after installing the NNM iSPI Performance for QA.

To check that the NNM iSPI Performance for QA is installed:

1. Select the **Help** → **System Information** in the menu toolbar.
2. In the System Information popup, go to the Extensions tab. If you can see NNM iSPI Performance for Quality Assurance under the HPE NNM iSPI Software Deployed section, the NNM iSPI Performance for QA is installed.

Click **Help** → **Help for NNM iSPIs** → **iSPI Performance for QA Help for Operators** for an explanation about these views added by the NNM iSPI Performance for QA

Note: You will see some or all of the workspaces and views described, depending on several factors:

- Your assigned NNMi [Security Group Mapping](#).
- The [HPE Network Node Manager i Smart Plug-in software](#) currently installed.
- Your NNMi administrator can integrate other applications into NNMi. Therefore, you might see things that are not described in the NNMi online help. Contact your NNMi administrator if you have questions about any additional items that are not described.

Views for Quality Assurance

View Title	Description
Probes	Lists all quality assurance probes discovered on the network.
Probes Critical	Lists all quality assurance probes that are in critical condition.
Probes Threshold Exceptions	Lists all quality assurance probes that experienced threshold violation.
Probes Baseline Exceptions	Lists all quality assurance probes that experienced baseline exceptions.

Views for Quality Assurance, continued

View Title	Description
QoS Interfaces	Lists all discovered interfaces for which the QoS Policies are configured.
QoS Policies	Lists all QoS policies that are configured on interfaces.
QoS Actions	Lists details of QoS Actions that are applied to interfaces based on particular traffic flows and policies.
QoS Interfaces Threshold Exception	Lists QoS interfaces for which any of the actions crossed the threshold.
QoS Actions Threshold Exceptions	Lists QoS actions that crossed the threshold.
Ping Latency Pairs	Lists ping latency pairs configured by the iSPI administrator.
QA Groups	Lists QA groups configured by the iSPI administrator.

For more information about workspaces:

Views for Traffic Analysis

Requires HPE Network Node Manager iSPI Performance for Traffic Software (NNM iSPI Performance for Traffic) – [click here for more information](#).

The following views are available in the Traffic Analysis workspace. You can view this workspace only after installing the NNM iSPI Performance for Traffic.

To check that the NNM iSPI Performance for Traffic is installed:

1. Select the **Help** → **System Information** in the menu toolbar.
2. In the System Information popup, go to the Extensions tab. If you can see NNM iSPI Performance for Traffic under the HPE NNM iSPI Software Deployed section, the NNM iSPI Performance for Traffic is installed.

Click **Help** → **Help for NNM iSPIs** → **NNM iSPI Performance for Traffic** for an explanation about these views added by NNM iSPI Performance for Traffic.

Note: You will see some or all of the workspaces and views described, depending on several factors:

- Your assigned NNMI [Security Group Mapping](#).
- The [HPE Network Node Manager i Smart Plug-in software](#) currently installed.
- Your NNMI administrator can integrate other applications into NNMI. Therefore, you might see things that are not described in the NNMI online help. Contact your NNMI administrator if you have questions about any additional items that are not described.

Views for Traffic Analysis

View Title	Description
Traffic Reporting Nodes	Lists the nodes that host flow collector interfaces that are capable of exporting traffic data.
Threshold Exceptions Reporting Nodes	Lists traffic data-reporting nodes that experienced threshold exceptions.
Traffic Reporting Interfaces	Lists the flow collector interfaces that are capable of exporting traffic data.
Threshold Exceptions Reporting Interfaces	Lists traffic data-reporting interfaces that experienced threshold exceptions.
Traffic Sites	Lists the sites defined by the iSPI administrator using the NNM iSPI Performance for Traffic Configuration Console.

For more information about workspaces:

Chapter 6: Using Views to Display Data

A view is the primary mechanism for displaying data. In the console, many views are available to help you visualize your network.

Type of Views in the NNMi Console



View Type	Strength
Table Views	Present summary information for a list of objects in a sorted order. Examples include: viewing a list of incidents sorted by Status and filtered by Lifecycle State.
Map Views	Display graphical relationships among objects.
Dashboard Views	Display at-a-glance data in the form of panels.

To access a view, select a [workspace](#) and then click the view that you want to display. Some views are also accessible from the console's **Actions** menu. See ["Using Actions to Perform Tasks" on page 173](#) for more information.

You can also right-click any object in a table or map view to access the items available within the **Actions** menu.

Note: Some NNMi users can delete nodes and other objects from the NNMi database (depending on the assigned NNMi Role). Any node that has been deleted appears as a transparent icon to all NNMi users until their map is refreshed using the  **Refresh** icon. After **Refresh**, the deleted node is removed from the map. NNMi does not automatically refresh the connectivity or set of nodes in a map view, except on the **Initial Discovery Progress** and **Network Overview** maps.

From a view, you can:

- ["Select Multiple Objects" on the next page](#)
- ["Refresh a View" on page 58](#) ()
- ["Refresh Node Status on a Map" on page 112](#) ()
- ["Stop Periodic Refresh of a View" on page 66](#) ()
- ["Using the View Toolbars" on page 159](#) to Display a View in a New Window ()
- ["Invoke Actions" on page 12](#)

Depending on the NNMi Role to which you are assigned, you may or may not be allowed to create or delete instances of some objects from the view. See **Help** → **Help for Administrators** for more information.

Related Topics

["Use Dashboard Views" on page 58](#)

["Use Table Views" on page 63](#)

["Use Map Views" on page 84](#)

Select Multiple Objects

You can select or deselect multiple objects when using a table or map view. This feature is useful when you want to access details or invoke an action on multiple objects, such as nodes, IP addresses, or interfaces.

Multiple Objects in Table Views

Tip: Look in the status bar of each table view to see the number of objects currently selected as well as the total number of objects in the view.

To select multiple objects in a table view:

Press Ctrl-Click to select the row for each object you want to select.

To de-select an object in a table view:

Re-select the row for each object you want to de-select.

Multiple Objects in Map Views

To select multiple objects in a map view:

Do one of the following:

- Use Ctrl-Click to select each object of interest on the map.
- Left-click the mouse and drag the cursor over the area of the map you want to select. When you use this method, NNMi indicates the selection area using a dotted line (or rubber band) as shown in the following example:

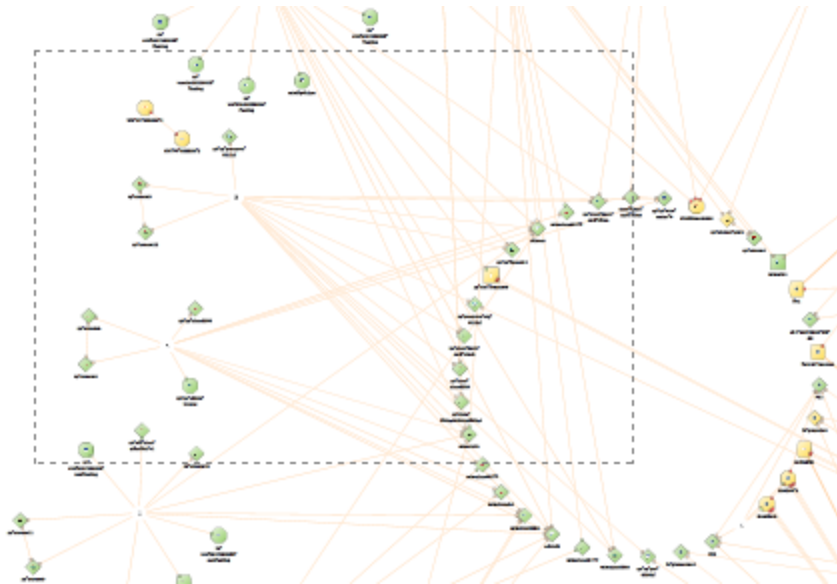

Each object you select changes to indicate it has been selected.

To de-select an object in a map view:

Re-select an object of interest on the map.

Each object you de-select returns to normal on the map.



Related Topics

["Select all Rows in a Table" on page 64](#)

Refresh a View

You can manually refresh a view at any time so that you are viewing the latest set of information. You cannot change the automatic refresh rate that was set by NNMI for each view.

To perform view Refresh, do one of the following:

- Display any view, then select the **View** → **Refresh** menu item.
- To refresh a table view, click the  Refresh icon in the table view.
The table view status bar displays the refresh rate and whether the refresh rate is enabled or disabled. (If disabled, clicking the  Refresh icon enables periodic refresh.)
- To refresh a map view, click the  Refresh icon in the map view toolbar to update changes in node placement, nodes added, and nodes deleted.
To refresh the status of nodes on a map, see ["Refresh Node Status on a Map" on page 112](#).

Related Topics

["Stop Periodic Refresh of a View" on page 66](#)

Use Dashboard Views

NNMI includes dashboard views, which, depending on the dashboard type, can contain multiple panels of data pertaining to the entire network, a specific object (for example, a node or interface), or a group of objects (such as a Node Group or Interface Group).

Dashboard views provide at-a-glance information, allowing you to easily compare and quickly isolate the information you need. Dashboard panels can contain tables and charts, some of which might be customizable. See ["Customize a Dashboard View" on the next page](#).

There are two types of dashboard views:

- ["Views available in the Dashboards Workspace" on page 25](#):
These views contain information scoped to the entire set of objects managed by this NNMI management server, constrained by the Security Groups to which the logged-in user belongs.
- ["Dashboard Views based on an Object" on the next page](#):
These views are scoped to a selected object. These are also further scoped by the Security Groups to which the logged-in user belongs.

For more information about dashboards:

Launch a Dashboard View from the Dashboard Workspace

To launch a dashboard view from the **Dashboards** workspace:

1. From the workspace navigation panel, click the **Dashboards** workspace.
2. Select the desired dashboard view. See ["Views available in the Dashboards Workspace" on page 25](#).

For more information about dashboards:

Dashboard Views based on an Object

Object-based dashboard views include a wealth of information about the selected object. The dashboard view presents at-a-glance information, allowing you to easily compare and quickly isolate the information you need to investigate and identify network problems:

- Dashboard panels can contain graphs, gauges, maps, and tables.
- Smart Plug Ins (iSPIs) add more information to the Dashboards, for example performance data might also be displayed. See "[About the Smart Plug Ins \(iSPIs\)](#)" on page 7.

There are multiple ways to "[Launch an Object-based Dashboard View](#)" below.

- **For more information about dashboards:**

Launch an Object-based Dashboard View

There are multiple ways to access an object-specific Dashboard view:

- Table views: Right-click any row in a table and select **Open Dashboard**.
- Map views: Right-click any map object and select **Open Dashboard**.
- Form's Analysis panel: Click any underlined item in a chart's legend to launch a customized Dashboard view specific to that selected object.
- Dashboard panels: Click any underlined item in a chart's legend to launch a customized Dashboard view specific to that selected object.

Smart Plug Ins (iSPIs) add more information to the Dashboards, for example performance data for Nodes and Interfaces. See "[About the Smart Plug Ins \(iSPIs\)](#)" on page 7.

Tip: After you display a dashboard, you can return to the previous screen using the breadcrumbs in the title bar.

For more information about dashboards:

Customize a Dashboard View

Some panels in Dashboard views can be filtered for a certain time period by using the **Time Filter**.

Drop-down in the top right corner of the Dashboard view:

Fine-tune bar:

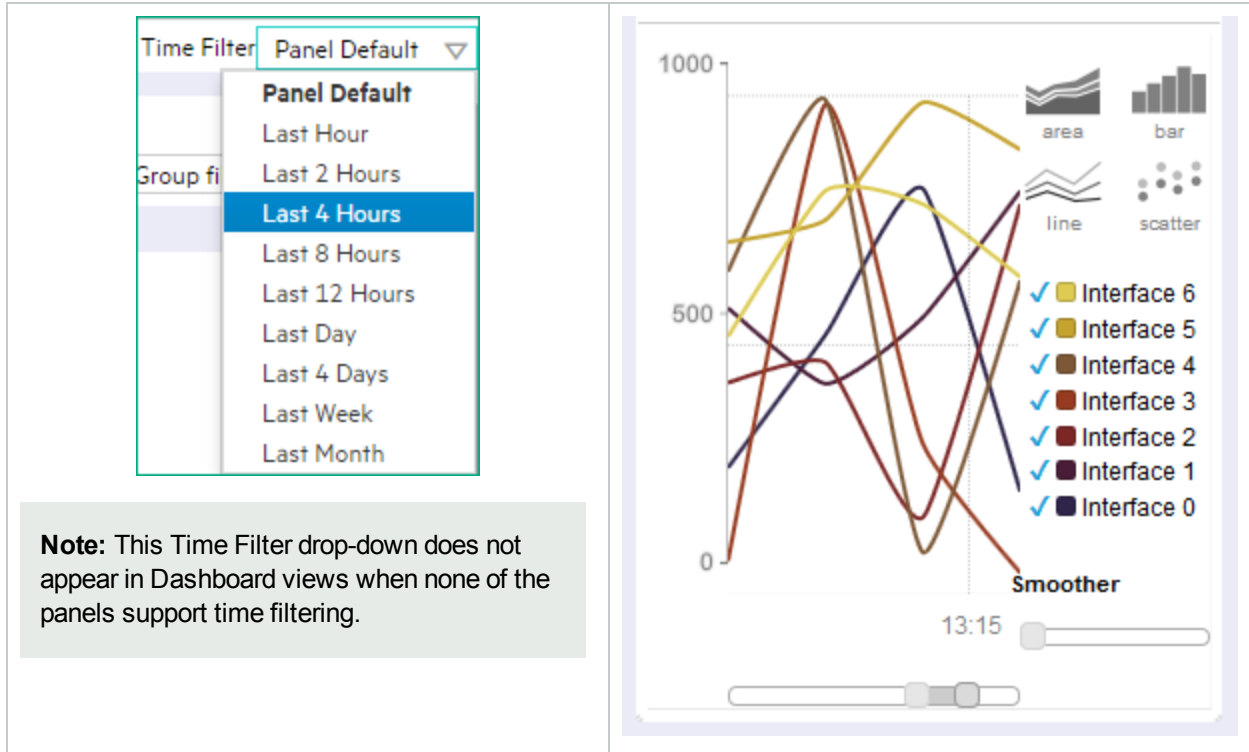

All panels that acknowledge the Time Filter setting display data according to the currently selected period in the Time Filter drop-down at the top of the Dashboard view and have the  icon on the top right corner of their panel toolbar:



By default, these panels display data for the last four hours.

You can customize a dashboard view in the following ways:

- ["Customize Charts" below](#)
- ["Minimize or Restore Dashboard Panels" on page 62](#)

For more information about dashboards:

Customize Charts

Certain dashboard panels display customizable area, bar, line, or scatter charts. Change the chart type by clicking one of the controls provided in the upper-right portion of the panel (choices might include area, bar, line, and scatter):



To customize a chart, do the following:

Tip: Click an underlined item in the chart Legend to launch a new Dashboard specific to that object.

- ✓ Click the checkmarks in the chart Legend to ✓ show or ✓ hide a subset of objects:

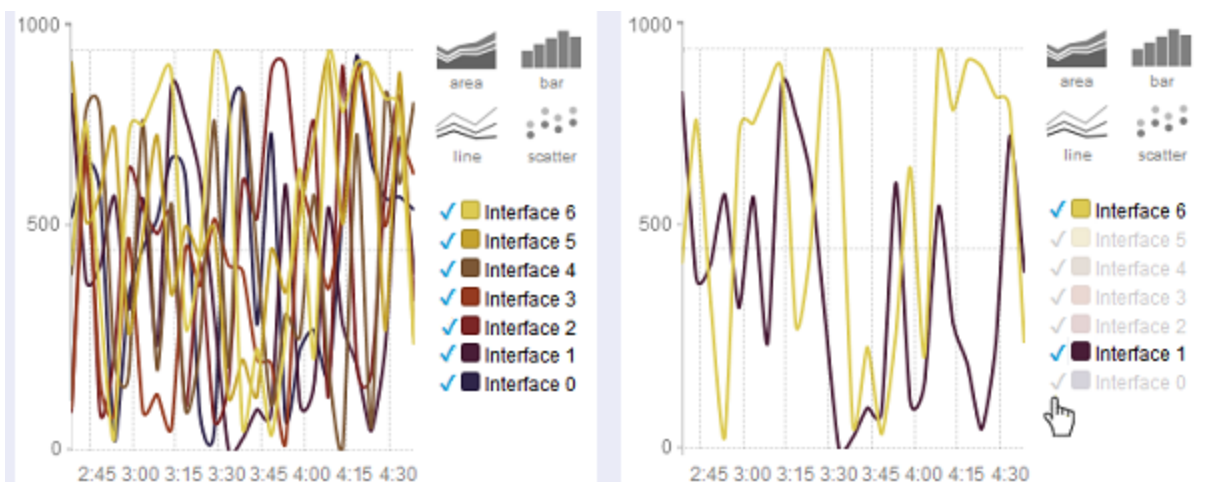

- Click a color tile in the chart Legend to instantly display only one specific object:

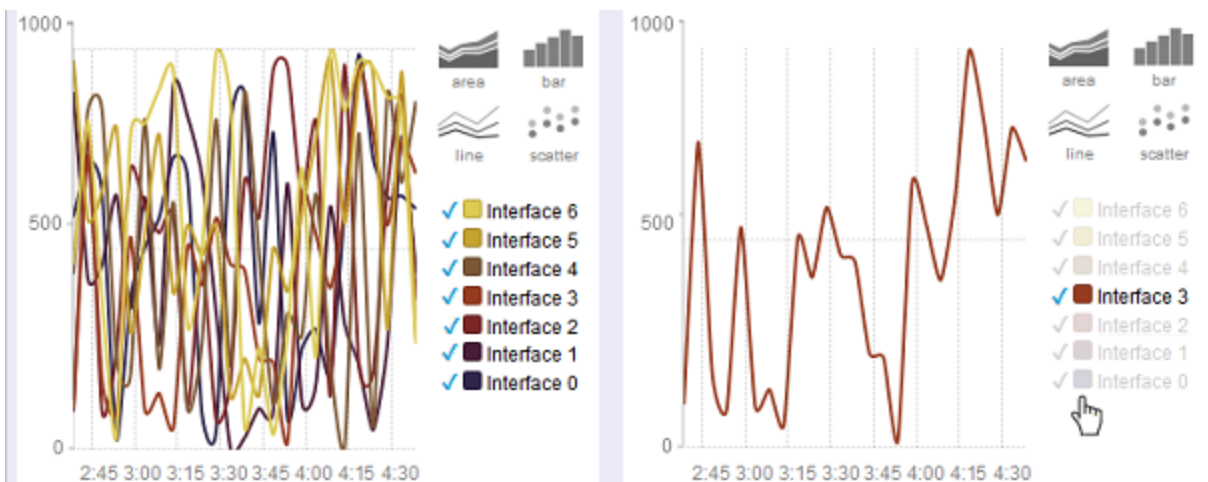

- Hover the cursor:
 - Over the component list to instantly view data for one particular component.
 - Over the chart to display a particular value at a particular time.

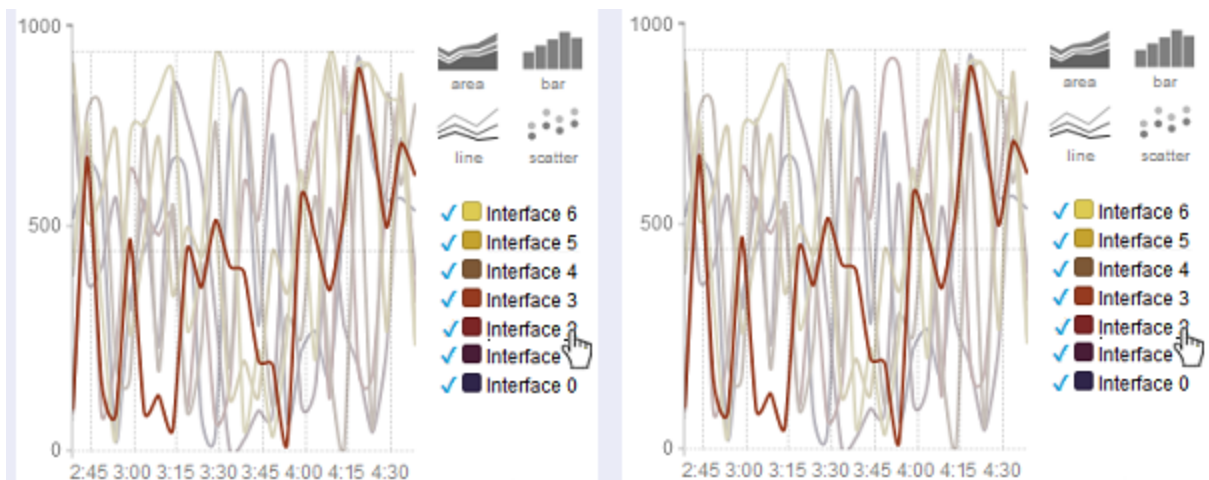

- Smooth the appearance of a chart by clicking and dragging the button in the **Smoother** control.



- Isolate the view to a particular timeframe by clicking and dragging the buttons on the slider beneath the chart under the time captions:

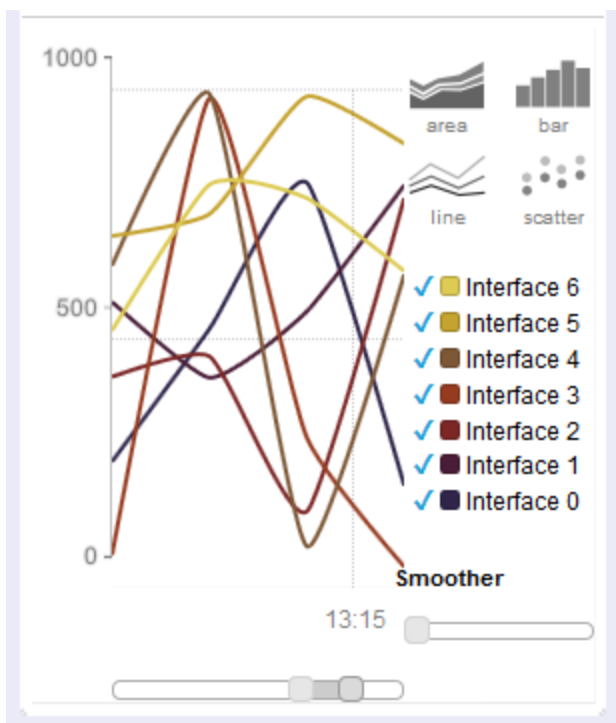

For more information about dashboards:

Minimize or Restore Dashboard Panels

Minimize a dashboard panel by clicking the  button available in the upper-left corner of a given panel's title bar.



Restore a dashboard panel by clicking the  button available in the upper-left corner of a given panel's title bar.



For more information about dashboards:

Use Table Views

Table views display data in tabular format. Each row displays data about one object. If there are more rows than fits on a single screen, you can scroll through the table view using the scroll bar.

If a table contains more rows than the maximum limit set for a table, filter your table view to reduce the number of rows. See ["Using the View Toolbars" on page 159](#) for more information about how NNMi indicates the table has exceeded the maximum limit specified. See ["Filter a Table View" on page 67](#) for information about how to filter a table view.

From a table view, in addition to the tasks accessed with the view display panel toolbar, you can perform the following tasks:

- ["Resize a Column" below](#)
- ["Hide a Column" on the next page](#)
- ["Sort Column Data " on page 65](#)
- ["Filter a Table View" on page 67](#)
- ["Restore Table Defaults" on page 81](#)
- ["Export Table Information" on page 82](#)
- ["Invoke Actions" on page 12](#)
- ["Access Object Information \(Forms and Analysis Pane\)" on page 12](#)

The following customizations are saved across browser sessions:

- Column width
- Hidden columns
- Sort column and order
- Column filters
- Quick filter value
- Node or interface group filter
- Time period filter (for incidents)

See ["Limits to View Settings" on page 83](#) for more information about the number of tables that have customizations that can be stored.

Resize a Column

You can resize columns using your mouse.

To resize a column in the table:

1. Mouse over the edge of the column until you see a ↔ resize icon.
2. Drag the column edge to the width you want.

Related Topics

["Hide a Column" below](#)

["Sort Column Data " on the next page](#)

Hide a Column

If you find you no longer want to include a column of information in your view, you can hide a specified column.

To hide a table column:

1. Right-click the column of interest.
2. Select **Visibility**.
The list of column names appears.
3. Click to clear the check box that precedes the name of the column you want to hide.

Related Topics

["Display a Hidden Column" below](#)

["Resize a Column" on the previous page](#)

["Sort Column Data " on the next page](#)

Display a Hidden Column

If you want to display a hidden column.

To display a hidden table column:

1. Right-click the column of interest.
2. Select **Visibility**.
The list of column names appears.
3. Click to check the check box that precedes the name of the column you want to display.

Related Topics

["Hide a Column" above](#)

["Resize a Column" on the previous page](#)

["Sort Column Data " on the next page](#)

Select all Rows in a Table

If you want to select all rows in a table.

To select all rows in a table:

1. Select any row in the table.
2. Do one of the following:
 - Press **Ctrl-a**.
 - Right-click any row in the table view, and select **Select All**.
3. The table view data appears highlighted.

Related Topics

["Filter a Table View" on page 67](#)

["Hide a Column" on the previous page](#)

["Resize a Column" on page 63](#)

["Restore Table Defaults" on page 81](#)

Sort Column Data

By sorting columns, you can get the most important information at the top of your table. For example, at times you might want to view all critical nodes. At other times, you might need to find node contact information.

To sort by columns:

1. Right-click the column heading or data cell on which you want to sort.
2. To sort the column in ascending order, select **Sort: → Ascending**
3. To sort the column in descending order, select **Sort: → Descending**

When sorting column data, note the following:

- You can click the column header to initiate a sort on the column values. Clicking the column heading again, reverses the sort direction.
- HPE Network Node Manager i Software Smart Plug-ins (iSPIs) might provide table views in which sorting is disabled for one or more columns.
- Sorting tables that contain large amounts of data (for example, viewing all interfaces or incidents), can sometimes result in slow response times. In this case, it is better to first filter the table information so that it contains only the values of interest before performing your sort.

More About Sorting

When sorting table columns, note the following:

- You can sort on only one column heading at one time.
- Capital letters are sorted separately from lowercase.

Note: The **Assigned To** column in incident views is sorted in alphabetical order according to the language locale that is set for the NNMi management server. When determining alphabetical order, NNMi uses the user display name rather than the actual login name and does not sort capital letters separately from lowercase. If you are an NNMi administrator, you can set the language locale for the sort order using the `server.properties` file. See the "Maintaining NNMi" chapter of the HPE Network Node Manager i Software Deployment Reference at <http://softwaresupport.hpe.com> for more information. The default sort locale value is English (en_US).

- NNMi sorts some table columns using lexicographical ordering. This might produce unfamiliar orders for strings such as Object IDs that contain numbers. For example you might expect the following order when sorting the sysObjectID data type:
 - 1.3.6.1.4.1.1
 - 1.3.6.1.4.1.3
 - 1.3.6.1.4.1.20

Using lexicographical ordering, these system object ID values are ordered as follows:

- 1.3.6.1.4.1.1
 - 1.3.6.1.4.1.20
 - 1.3.6.1.4.1.3
- Some table columns, such as Status and ifType, display data types which have a natural sort order that is distinct from an alphabetical order. When sorting these columns, the values are sorted according to a natural or pre-determined order rather than alphabetically. For example when sorting the Status column, you always see the following order (ascending) or the reverse (descending): **Critical, Major, Minor, Warning, Unknown, Disabled, Normal, and No Status**.
 - Your sort choices are saved across user sessions.

Related Topics

["Filter a Table View" on the next page](#)

["Hide a Column" on page 64](#)

["Resize a Column" on page 63](#)

["Restore Table Defaults" on page 81](#)

["Select all Rows in a Table" on page 64](#)

Stop Periodic Refresh of a View

You can manually stop the periodic refresh of the group of items displayed in a table view at any time.

Note: The status of this group of objects is always updated on a regular basis, you are only stopping updates based on network objects being added or deleted from the NNMi database.

NNMi's status bar displays the refresh rate and whether the refresh rate has been disabled.

To stop the periodic refresh of a table view:

1. In the view toolbar, click the  Stop Periodic Refresh icon. The following message displays in the [Status Bar](#) at the bottom-right corner of the table:

Auto refresh: OFF

2. If you want to restart the refresh rate, click the  Refresh icon in the view toolbar. The following message displays in the Status Bar at the bottom-right corner of the table:

Auto refresh: 3 min

Note: You cannot change the *refresh rate*. NNMi sets that default rate for each view.

Related Topics

["Refresh a View" on page 58](#)

Filter a Table View

When using table views, you can reduce the amount of information displayed by filtering a view using one of the object's attribute values. For example, you can access only those incidents that have a Status of **Critical**, or only those incidents that have a Description that is **Interface Down**.

Filtering a table view is also useful to reduce the number of rows when a table contains more rows than the maximum limit set for a table. See ["Using the View Toolbars" on page 159](#) for more information about how NNMi indicates the table has exceeded the maximum limit specified.

When a view is first displayed, it displays a set of filtered columns based on the view definition provided by NNMi.

Note: The view status bar indicates if one or more filters have been set for the view. FILTER:ON indicates that one or more filters have been set. These are filters that you can modify. In some views, NNMi provides factory set filters that cannot be changed. For example, the My Open Incidents view is filtered on the Assigned To attribute, which cannot be changed. FILTER:OFF indicates no modifiable filters have been set for the view. These views might have factory set filters.

When specifying filters, you can perform the following tasks:

Drop-Down List Selection Filters

- ["Filter Tables by Node or Interface Group" on page 69](#)
- ["Filter by Time Period \(Incident Views Only\)" on page 70](#)

Column Selection Filters

- ["Filter by Attribute Value" on page 71](#)
- ["Modify a Table View Filter" on page 76](#)
- ["Remove a Filter" on page 80](#)
- ["Restore Default Filters" on page 80](#)
- ["Display Current Filter Settings" on page 80](#)

When using filters, note the following:

- You can filter on multiple table columns. The resulting filter is a logical AND of the filters for all of the columns.
- HPE Network Node Manager i Software Smart Plug-ins (iSPIs) might provide table views in which filtering is disabled for one or more columns.
- NNMi matches to the milliseconds when filtering on columns that represent time values (for example, **Last Occurrence**). Therefore, only those times that match to the milliseconds are included in your view. Try

using the **less than or equal** or **greater than or equal** filter options to include a wider range of time values.

- NNMi restricts certain filter operations or options per data type. Only the filter options that apply to the attribute data type appear. The data types and valid filter options are described in the table below.
- A different subset of these filter options appears depending on whether you are clicking a data cell, a column header, or a blank row. A data cell filter menu includes filters that use the value of the selected data cell.

Filter Options Available

Data Type	Valid Filter Options
All data types	Equals this value Not equal to this value See "Filter by Attribute Value" on page 71 for more information.
Text (String) Numeric Enumerated List IP Address Date and Time	Create Filter...
Boolean data types	Is true Is false
Numeric (Integer, IP address, and date)	Greater than or equal to this value Less than or equal to this value See "Filter by Attribute Value" on page 71 for more information.

Additional Filter Options Available

Data Type	Valid Filter Options
Group Filter	Provides a drop-down menu in the view display panel toolbar of the node and interface groups available to you. See "Filter Tables by Node or Interface Group" on the next page for more information about group filters.
Quick Filter	Provides a drop-down menu in the view display panel toolbar of all of the possible values for an attribute. These drop-down menus are provided for table views that include "by" in the view name.
Time Period Filter	Provides a drop-down menu in the view display panel toolbar in incident views. This filter lists a variety of time periods for which you can filter your incident views. Possible values include: Last 5 minutes, Last Hour, Last 8 Hours, Last Day, Last 3 Days, Last Week, Last Month, and All. See "Filter by Time Period (Incident Views Only)" on page 70 for more information.

Filter Tables by Node or Interface Group

NNMi lets you filter your table views by node or interface group. For example, you might want to view all of the important Cisco routers, or all of the Voice-Over-IP interfaces within your network.

Your NNMi administrator creates these groups. They are listed in a "group selector" drop-down menu list on the view toolbar as shown below:

A screenshot of a dropdown menu with the text "Node or Interface Group Filter" and a downward-pointing arrow on the right side.

Node Group filters are available for:

- Node views
- Interface views
- IP address views
- Incident views
- Node Sensor views
- Physical Sensor views

Interface Group filters are available for:

- Interface views
- IP Address views
- Card views

To filter a view by Node or Interface Group:

1. Navigate to the view of interest.
 - a. From the workspace navigation panel, select the workspace that contains the view you want to use; for example, **Inventory**.
 - b. Select the view of interest; for example, **Interfaces**.
2. In the  group selector drop-down list, select the Node Group or Interface Group you want to use as a filter.

When using Node Group or Interface Group filters, note the following:

- By default, table views are not filtered by Node or Interface Group.
- If a view can be filtered by both Node Group and Interface Group, the selection box lists the Node Groups first, followed by the Interface Groups. Each list appears in alphabetical order.
- When the filter is applied, the view automatically refreshes to show the appropriate set of objects.
- If you set a Node Group or Interface Group filter, NNMi combines the group filter with any other filters using the AND Boolean operator.
- To clear the group filter, return the selection value to "<Set node group filter>" or "<Set node or interface group filter>".

Related Topics

["Filter by Attribute Value" on page 71](#)

["Modify a Table View Filter" on page 76](#)

["Remove a Filter" on page 80](#)

["Restore Default Filters" on page 80](#)

["Display Current Filter Settings" on page 80](#)

About Node and Interface Groups

When monitoring your network, you might be interested in only viewing information for a particular set of nodes or interfaces. Your network administrator can group sets of nodes or interfaces into node or interface groups. An example Node Group could be all important Cisco routers, or all routers in a particular building. As another example, all interfaces used for Voice-Over-IP might be grouped together in your network.

Your administrator configures Node Groups based on any of the following:

- Vendor or model SNMP object identifiers.
- Specific devices identified by name or IP address.
- Devices identified with wildcard characters to define a Node Group. These groups might be based on a naming strategy that is set in place for your organization.

Note: Node Groups can also control how NNMi monitors network devices. For example, your administrator might configure each group to have a different health monitoring interval.

You can display the definition of a group:

- **Node Group definitions**

- a. From the workspace navigation panel, select the **Inventory** workspace.
- b. Select the **Node Groups** view.
- c. Double-click the row representing the Node Group.
- d. The Node Group form displays.
- e. When finished, click the  Close icon.

- **Interface Group definitions**

- a. From the workspace navigation panel, select the **Inventory** workspace.
- b. Select the **Interface Groups** view.
- c. Double-click the row representing the Interface Group.
- d. The Interface Group form displays.

Interface group definitions match the way your team identifies important network devices. Each interface group can include one or more interface-type specifications (based on industry-standard IANA ifType-MIB variables).

- e. When finished, click the  Close icon.

Special Actions are provided for Node Groups and Interface Groups. See [Using Actions to Perform Tasks](#).

Filter by Time Period (Incident Views Only)

Incident views enable you to filter your view by time period. Filtering using the time period filter lets you focus on the most recent incidents of interest. The available time periods include:

- Last 5 Minutes
- Last Hour
- Last 8 Hours

- Last Day
- Last 3 Days
- Last Week
- Last Month
- All

Note: A month is defined as 31 days.

Filter by Attribute Value

When specifying filters based on attribute (column) values, some filter options require that you specify the value by selecting the value in an object instance and some require that you open a Create Filter... dialog to specify the value. You can also specify a filter based on whether an attribute contains a value.

- ["Select Filter Values" below](#)
- ["Create a Filter to Specify Values" on the next page](#)
- ["Use Null Value Filters" on page 76](#)

Select Filter Values

The following filter options require an attribute value as the basis for the filter.

Note: When using the filter options listed below, first right-click the value in the table on which you want to filter.

Filter Settings

Filter Option	Description
Equals this value	NNMi displays only instances that contain the attribute value you specify.
Not equal to this value	NNMi displays only instances that have an attribute value that does <i>NOT</i> contain the value specified. You can specify multiple values for this filter; but can only supply one value each time you select this option. Note: For certain attributes, this option can also filter values that are "empty" or null.
Greater than or equal to this value	NNMi displays only instances that contain the attribute values that are greater than or equal to the value you specify.
Less than or equal to this value	NNMi displays only instances that contain the attribute values that are less than or equal to the value you specify.
Is true	NNMi displays only instances that have an attribute value that contains the value true .

Filter Settings , continued

Filter Option	Description
Is false	NNMi displays only instances that have an attribute value that contains the value false .

You can change a filter at any time. NNMi saves filters per user so that the filters you specify are maintained during subsequent user sessions. See ["Limits to View Settings" on page 83](#) for information about the number of tables that have customizations that can be saved based on your web browser. See ["Restore Table Defaults" on page 81](#) for information about how to remove table view customizations.

To filter your view by selecting an attribute value in the table:

1. Right-click the attribute value on which you want to base your filter.
2. Select one of the following filter options:
 - **Equals this value**
 - **Not equal to this value**
 - **Greater than or equal to this value**
 - **Less than or equal to this value**
 - **Is true**
 - **Is false**

NNMi displays a table view of all instances that have been selected based on the filter option and attribute values you specified or selected.

Each filtered column is indicated using the  filter icon.

Related Topics

["Use Null Value Filters" on page 76](#)

Create a Filter to Specify Values

NNMi enable you to provide attribute values on which you want to filter. You can provide attributes values by creating a filter for any of the following types of values:

- Text (String)
- Numeric
- Enumerated List
- IP Address
- Date and Time

To filter information by specifying one or more values:

1. Right-click the column or attribute on which you want to filter.
2. Select **Create filter...**

NNMi displays the Filter Dialog that is appropriate for the selected column's data type.
3. In the Create Filter ... Dialog displayed:

- a. Select a Filter Option (see [Filter Option tables](#)).
- b. Specify one or more valid values (see [Valid Filter Values](#))

If your NNMi administrator is using Lightweight Directory Access Protocol (LDAP) to store user name information, NNMi shows the configured display name in the Incident **Assigned To** column, but internally stores the user name that identifies the user account. To specify a filter for the Incident **Assigned To** column, do one of the following:

- o Specify the user name as the filter value.
- o Right-click the **Assigned To** on which you want to filter. Then, select **Filter > Equals this value** or **Filter > Not equal to this value**. NNMi creates the filter using the stored user name value.

If you are an NNMi administrator, see the "Maintaining NNMi" chapter in the HPE Network Node Manager i Software Deployment Reference for more information about configuring the Incident **Assigned To** display name.

4. Click **Apply**.

NNMi displays a table view of all instances that have been selected based on the filter option and attribute values you specified or selected.

Each filtered column is indicated using the  filter icon.

Text (String) Filter Options

Filter Option	Description
starts with	<p>NNMi displays only instances that have an attribute value that starts with the text string value specified.</p> <p>Use this option when you are looking for an entry that begins with a specific string value. For example if all of your Cisco devices started with the text string "Cisco", and you wanted to find all Cisco devices, you could use the value string "Cisco".</p>
contains	<p>NNMi displays only those instances that have an attribute value that contains the text string value you enter.</p> <p>You can use the wildcard character ("*") to match one or more characters within the contains value. For example, c*m matches the following values:</p> <p>3com9000</p> <p>callmgr1</p>
matches	<p>NNMi displays only those instances that have an attribute value that matches the text string value you enter.</p> <p>Use the question mark (?) to match one character.</p> <p>Use the asterisk (*) as a wildcard character to match zero or more characters.</p>
less than or equal to	<p>NNMi performs an alphabetical (lexicographical) comparison and displays all text string values that are before the text string value you enter.</p>
greater	<p>NNMi performs an alphabetical (lexicographical) comparison and displays all text string values</p>

Text (String) Filter Options , continued

Filter Option	Description
than or equal to	that are after the text string value you enter.

Numeric Filter Options

Filter Option	Description
equals	NNMi displays only instances that contain the numeric value or values you specify.
not equals	NNMi displays only instances that have an attribute value that does <i>NOT</i> contain the numeric value or values specified. <div style="background-color: #e0e0e0; padding: 5px;">Note: For certain attributes, this option can also filter values that are "empty" or null.</div>
greater than or equal to	NNMi performs an alphabetical (lexicographical) comparison and displays all text string values that are after the text string value you enter.
less than or equal to	NNMi displays all values that are less than or equal to the numeric value you enter

Enumerated List Filter Options

Filter Option	Description
equals	NNMi displays only instances that contain the value or values you select.
not equals	NNMi displays only instances that have an attribute value that does <i>NOT</i> contain the value or values you selected. <div style="background-color: #e0e0e0; padding: 5px;">Note: For certain attributes, this option can also filter values that are "empty" or null.</div>

IP Address Filter Options

Filter Option	Description
equals	NNMi displays only instances that contain the IP Address value you specify.
range	NNMi displays only instances that are within the IP Address range you specify.
is empty	NNMi displays only the instances that do not have a value for this attribute.
is not empty	NNMi displays only the instances that contain a value for this attribute.

Date and Time Filter Options

Filter Option	Description
on or after	NNMi displays only instances that have date and time values that occur on or after the date and time you specify.
on or before	NNMi displays only instances that have date and time values that occur on or before the date and time you specify.
between	NNMi displays only instances that have date and time values that occur after the first date and time you specify and before the second date and time you specify. Use the between operator when you want to filter on instances that occur within a specified hour or day.

Valid Filter Values

Data Type	Description
Wildcards	% or * means multiple characters allowed at that location. ? or _ means any single character allowed at that location.
Text	Enter the value for which you want NNMi to search. Text (string) filters are case sensitive.
Numeric	Enter the numeric value or values for which you want NNMi to search. To enter more than one numeric value, enter a comma-separated list.
Enumerated List	Select one or more values from the enumerated list.
IP Address	Enter an IP Address or range of addresses using two IP addresses separated by a '-' or using Classless Inter-Domain Routing (CIDR) notation: IPv4 examples: 10.168.0.1 - 10.168.13.1 10.2.120.0/21 IPv6 examples (<i>NNMi Advanced</i>): 2001:d88:a00:: - 2001:d88:aff:ffff:ffff:ffff:ffff:ffff 2001:d88:0:a00::/56
Date and Time	You must enter either a date or time or both. When entering a date only the day is required. When entering the time only the minutes are required. Note: NNMi uses a 24-hour clock, beginning at midnight (which is 0000 hours). For example, 1:00 AM is 0100 hours, 2:00 AM is 0200 hours, and 11:00 PM is 2300 hours.

Related Topics

["Select Filter Values" on page 71](#)

["Use Null Value Filters" below](#)

Use Null Value Filters

NNMi provides the following filter options to filter your view based on whether the attribute contains a value. These filter options appear for data types that do not require a value:

- Is not empty
- Is empty

To filter your view based on null values:

1. Right-click the column or attribute value on which you want to filter.
2. Select from the filter options described in the [table below](#).
3. NNMi displays a table view of all instances that have been selected based on the filter option and any attribute values you specified or selected.

Each filtered column is indicated using the  filter icon.

You can change a filter at any time. NNMi saves filters per user so that the filters you specify are maintained during subsequent user sessions.

Filter Choices

Filter Option	Description
Is not empty	NNMi displays only the instances that contain a value for this attribute.
Is empty	NNMi displays only the instances that do not have a value for this attribute.

Related Topics

["Select Filter Values" on page 71](#)

Modify a Table View Filter

You can change a filter for a table view at any time. NNMi saves filters per user so that the filters you specify are maintained during subsequent user sessions.

To modify a filter :

1. Right-click the column or attribute on which you want to filter.
2. Select **Modify filter...**

Note the following:

- If a filter is not created for the selected table column, the **Modify filter....** option does not appear.
- If you have used an existing attribute value with the **Not equal to this value** filter, you can select an additional attribute value and select **Not equal to this value also**.
- NNMi displays the filter dialog that is appropriate for the selected column's data type. If the filter was

created using the “Not equal to this value” option with the Text (String) or IP address data type, NNMi does not include the values for the current filter.

3. In the Modify Filter ... dialog displayed:
 - a. Select a Filter Option (see [Filter Option tables](#)).
 - b. Specify one or more valid values (see [Valid Filter Values](#)).
4. Click **Apply**.

NNMi replaces the previous filter with the new filter values. NNMi displays a table view of all instances that have been selected based on the filter option and attribute values you specified or selected.

Each filtered column is indicated using the  filter icon.

Text (String) Filter Options

Filter Option	Description
start with	<p>NNMi displays only instances that have an attribute value that starts with the text string value specified.</p> <p>Use this option when you are looking for an entry that begins with a specific string value. For example if all of your Cisco devices started with the text string "Cisco", and you wanted to find all Cisco devices, you could use the value string "Cisco".</p>
contains	<p>NNMi displays only those instances that have an attribute value that matches the text string value you enter.</p> <p>You can also use a wildcard character (*) within your string value.</p> <p>If a wildcard is not specified, this filter option finds those values that exactly match the value string you enter. For example, if you wanted to find only the Cisco1 device from the following list of values, you would use "Cisco1" as your value string:</p> <ul style="list-style-type: none"> • Cisco1 • Cisco12 • Cisco123 <p>In this example, NNMi would not include Cisco12 and Cisco123.</p>
matches	<p>NNMi displays only those instances that have an attribute value that matches the text string value you enter.</p> <div style="background-color: #e0e0e0; padding: 5px;"> <p>Note: Do not use the asterisk (*) within your string value unless you want NNMi to match * (asterisk).</p> </div>
less than or equal	<p>NNMi performs an alphabetical (lexicographical) comparison and displays all text string values that are before the text string value you enter.</p> <div style="background-color: #e0e0e0; padding: 5px;"> <p>Note: Not all text (string) column values include this option.</p> </div>
greater	<p>NNMi performs an alphabetical (lexicographical) comparison and displays all text string values</p>

Text (String) Filter Options , continued

Filter Option	Description
than or equal	that are after the text string value you enter. Note: Not all text (string) column values include this option.

Numeric Filter Options

Filter Option	Description
equal	NNMi displays only instances that contain the numeric value or values you specify.
not equal	NNMi displays only instances that have an attribute value that does <i>NOT</i> contain the numeric value or values specified.
greater than or equal	NNMi performs an alphabetical (lexicographical) comparison and displays all text string values that are after the text string value you enter.
less than or equal	NNMi displays all values that are less than or equal to the numeric value you enter.

Enumerated List Filter Options

Filter Option	Description
equal	NNMi displays only instances that contain the value or values you select.
not equal	NNMi displays only instances that have an attribute value that does <i>NOT</i> contain the value or values you selected.

IP Address Filter Options

Filter Option	Description
equal	NNMi displays only instances that contain the IP Address value you specify.
range	NNMi displays only instances that are within the IP Address range you specify.

Date and Time Filter Options

Filter Option	Description
on or after	NNMi displays only instances that have date and time values that occur on or after the date and time you specify.
on or before	NNMi displays only instances that have date and time values that occur on or before the date and time you specify.
between	NNMi displays only instances that have date and time values that occur after the first date and time you specify and before the second date and time you specify. Use the between operator when you want to filter on instances that occur within a specified hour or day.

Valid Filter Values

Data Type	Description
Text	Enter the value for which you want NNMi to search. Text (string) filters are case sensitive.
Numeric	Enter the numeric value or values for which you want NNMi to search. To enter more than one numeric value, enter a comma-separated list.
Enumerated List	Select one or more values from the enumerated list.
IP Address	Enter an IP Address or range of addresses using two IP addresses separated by a '-' or using Classless Inter-Domain Routing (CIDR) notation: IPv4 examples: 10.168.0.1 - 10.168.13.1 10.2.120.0/21 IPv6 examples (<i>NNMi Advanced</i>): 2001:d88:a00:: - 2001:d88:aff:ffff:ffff:ffff:ffff:ffff 2001:d88:0:a00::/56
Date and Time	You must enter either a date or time or both. When entering a date only the day is required. When entering the time only the minutes are required. Note: NNMi uses a 24-hour clock, beginning at midnight (which is 0000 hours). For example, 1:00 AM is 0100 hours, 2:00 AM is 0200 hours, and 11:00 PM is 2300 hours.

Related Topics

["Filter Tables by Node or Interface Group" on page 69](#)

["Filter by Attribute Value" on page 71](#)

["Remove a Filter" below](#)

["Restore Default Filters" below](#)

["Display Current Filter Settings" below](#)

Remove a Filter

NNMi lets you remove a filter for a selected column at any time.

To remove a filter:

1. Right-click the column that has a filter that you want to remove.
2. Select **Remove filter** from the drop-down menu.

NNMi removes all existing filters that have been set for that column.

Related Topics

["Modify a Table View Filter" on page 76](#)

["Modify a Table View Filter" on page 76](#)



["Restore Default Filters" below](#)

Restore Default Filters

You can restore the default filters for a view. This option removes any filters that you have defined for the current view.

To restore the default filter settings:

In the table toolbar, click the  **Restore Default Filters** icon.

Note: If you are viewing a table that appears in the form, open the table in a new window using the  **Show View In New Window** icon, and then click the  **Restore Default Filters** icon.

All filters are reset to the default values and any filters that you have created are removed for the current view.

Note: You will lose any selections you have in the view.

Related Topics

["Display Current Filter Settings" below](#)

["Remove a Filter" above](#)

Display Current Filter Settings

To keep track of the filters you have created, you can view the filter that has been set on a column by column basis.

To view a column's filter:

Mouse over the column of interest.

The example below shows the filter option and the string provided for that filter:

The following table explains the symbols used for each filter option

Filter Definitions

Symbol	Filter Option
<=	Less than or equal to this value
>=	Greater than or equal to this value
=	Equals this value
NOT IN	Not equal to this value
IS NULL	Is empty
IS NOT NULL	Is not empty
LIKE	Contains string... Starts with string... Matches string...

Note: The percent sign (%) represents the wildcard character.

Related Topics

["Restore Default Filters" on the previous page](#)

["Modify a Table View Filter" on page 76](#)



["Modify a Table View Filter" on page 76](#)

["Remove a Filter" on the previous page](#)

Restore Table Defaults

You can remove the types of table view customizations described in the following table. Remove customizations when you no longer find them useful or when you reach the limit for the maximum number of customizations that can be stored. See ["Limits to View Settings" on page 83](#) for more information about the number of tables that have customizations that can be stored.

If you are concerned about reaching your table view settings limit, remove view settings for tables that are not important.

Note: The  **Restore Default Filters** icon does not appear on table views in forms. If you want to clear settings from a table view that appears in a form, use the  **Show View in New Window** icon to open the table view in a new window and perform these operations.

Restore Default Table View Settings

What You can Remove	How	Description
Only table view filters	From the view display panel toolbar, select  Restore Default Filters .	Clears all customizations to filters for the table view and refreshes the view with the view's default filter settings.
All customizations for all table views	Select View → Restore All Default View Settings	Clears all customizations (and cookies) for all table view customizations. See " Limits to View Settings " on the next page for more information about how NNMi uses cookies to store table view customizations.

Related Topics

["Filter a Table View" on page 67](#)

["Hide a Column" on page 64](#)

["Resize a Column" on page 63](#)

["Restore Table Defaults" on the previous page](#)

["Select all Rows in a Table" on page 64](#)

Export Table Information

You can export the contents of a table view for use in other applications. You can choose to export only the rows that are selected or all of the rows in your table.

Note: You must have a minimum of Operator Level1 Role to export table information.

When printing table information, note the following:

- The first column of table information does not appear in the exported version. The contents of this column is for selection purposes only.
- You can copy and paste the table data to other applications, such as Microsoft Excel, for additional editing and manipulating, such as getting a list of hostnames.

To export selected table rows:

1. Select the row or rows that you want to export.
2. Right-click a selected row.
3. Select **Export to CSV**.
NNMi displays the **Export to CSV** dialog.
4. To included the table column headings in the exported data, click to check **Include Column Headings**.
5. NNMi stores date and enumerated values in both localized (Jul 12, 2010 10:07 AM) and raw (1278950859739) format. By default, NNMi exports only the localized (human readable) format for date and enumerated values.

Select the **Use Localized (Human Readable) Data** option to include only the localized (human readable) format for both dates and enumerated values.

Select the **Use Raw (Computer Readable) Data** option to include only the raw (computer readable) format for both date and enumerated values.

6. In the **Opening <file_name>** dialog, select one of the following options.
 - a. **Open with** to view the file contents.
 - b. **Save File** to save the file to a specified file name.

To export all table rows:

1. Right-click any cell or column header with the table.
2. Click **Select All**.
3. Right-click a row.
4. Select **Export to CSV**.
NNMi displays the **Export to CSV** dialog.
5. To included the table column headings in the exported data, click to check **Include Column Headings**.
6. NNMi stores date and enumerated values in both localized (Jul 12, 2010 10:07 AM) and raw (1278950859739) format. By default, NNMi exports only the localized (human readable) format for date and enumerated values.

Select the **Use Localized (Human Readable) Data** option to include only the localized (human readable) format for both dates and enumerated values.

Select the **Use (Computer Readable) Raw Data** option to include only the raw (computer readable) format for both date and enumerated values.

7. In the **Opening <file_name>** dialog, select one of the following options.
 - a. **Open with** to view the file contents.
 - b. **Save File** to save the file to a specified file name.

Related Topics

["Filter a Table View" on page 67](#)

["Hide a Column" on page 64](#)

["Resize a Column" on page 63](#)

["Restore Table Defaults" on page 81](#)

["Select all Rows in a Table" on page 64](#)

Limits to View Settings

NNMi automatically saves the following kinds of table view settings:

- Column width
- Hidden columns
- Sort column and order
- Filters

When customizing table views, note the following:

- All settings for each table are stored in a corresponding cookie for that table.
- The number of tables that have settings that can be saved, and the behavior when the limit is reached depends on the browser you use:
Microsoft Internet Explorer discards your oldest cookie and lets you continue creating customizations. If you are using Microsoft Internet Explorer, the cookie limit is 48.
If you are using Mozilla Firefox, the cookie limit is 48. If you reach the 48 limit, Mozilla Firefox removes the next to last cookie before saving the latest cookie created.
- Table view settings are specific to each operating system user. Therefore, if you log on as a different operating system user, you will have *different* view settings. If you sign into NNMi as a different NNMi user, but as the same operating system user, you will have *the same* view settings.

Note: NNMi displays a warning message when your last cookie and subsequent table settings are being saved.

You can remove the customizations for all of your tables using the **View** → **Restore All Default View Settings**. See ["Restore Table Defaults" on page 81](#) for more information.

Related Topics

["Restore Default Filters" on page 80](#)

["Hide a Column" on page 64](#)

["Resize a Column" on page 63](#)

["Select all Rows in a Table" on page 64](#)

Use Map Views

A map view is a powerful way to display information about your network. In a map view, nodes, interfaces, IP address, and subnets are represented as symbols on the map. The lines between the nodes and interfaces represent the connection or relationship between these objects.

For each symbol, a background shape indicates the type of device, such as router or switch. See ["About Map Symbols" on page 92](#). The color of this background shape indicates the current health of the device. See ["About Status Colors" on the next page](#) for more information about map color values.

On the maps, a foreground image is placed over the background shape. The foreground image identifies the make and model of the network device.

You access map views from the Topology Maps and Troubleshooting workspaces. You can also open maps from table views using the **Actions** menu. See ["Access Maps Provided by NNMi" on page 113](#) and ["Using Actions to Perform Tasks" on page 173](#) for more information.

Tip: You can also right-click any object in a table or map view to access the items available within the **Actions** menu.

Depending on the type of map you are viewing, NNMi uses additional conventions to depict other kinds of objects on the map:

["Node Group Map Objects" on page 98](#)

["Layer 2 Map Objects" on page 99](#)

["Layer 3 Map Objects" on page 103](#)

["Path View Map Objects" on page 104](#)

Note: Some NNMi users can delete nodes and other objects from the NNMi database (depending on the assigned NNMi Role). Any node that has been deleted appears as a transparent icon to all NNMi users until their map is refreshed using the  **Refresh** icon. After **Refresh**, the deleted node is removed from the map. NNMi does not automatically refresh the connectivity or set of nodes in a map view, except on the **Initial Discovery Progress** and **Network Overview** maps.

You can perform the following operations in a map view:

- ["Access Object Information \(Forms and Analysis Pane\)" on page 12](#)
- ["Refresh a View" on page 58](#)
- ["Change the Map Layout" on page 106](#)
- ["Adjust the Zoom Factor" on page 109](#)
- ["Pan Around the Map" on page 110](#)
- ["Set the Location of the Overview Pane" on page 111](#)
- ["Refresh Node Status on a Map" on page 112](#)
- ["Control Tool Tips Information on a Map" on page 113](#)

If you use the Mozilla Firefox browser and have any timeout issues; for example, being prompted to click **Continue** before a map appears, see ["Configure Mozilla Firefox Timeout Interval" on page 5](#).

Related Topics

["Use Table Views" on page 63](#)

["About Workspaces" on page 19](#)

Understand Maps

To understand how to interpret the contents of maps provided by NNMi, you want to know the following:

- [About Status Colors](#)85
- [About Map Symbols](#)92
- [Node Group Map Objects](#)98
- [Layer 2 Map Objects](#)99
- [Layer 3 Map Objects](#)103
- [Path View Map Objects](#) 104

About Status Colors

The color of the background shape of each map symbol conveys the most recent health status of that Node. The color of each connection icon (the line) conveys the most recent health of communication between the two Nodes (determined by evaluating the status of each Interface or IP address involved). At the end of each connection line, the color of each interface icon (small square) or IP address icon (small hexagon) also conveys its most recent health status. For example:

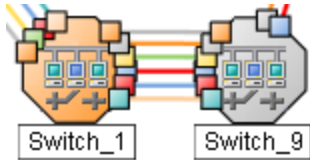

NNMi calculates the appropriate Status for objects:

- ["Status Color for Objects" below](#)
- ["Status Color for Aggregator Objects \(NNMi Advanced\)" on the next page](#)
- ["Status Color for Network Connections" on page 89](#)

Tip: NNMi's Causal Engine collects the data for calculating each object's Status value. Using the State information collected by the State Poller as well as this additional information, the Causal Engine calculates the Status of each Node, Interface, and SNMP agent.









- State = This value is provided by the NNMi State Poller and is always up to date for each object.
- Status = This value can run behind by the amount of time listed for *Delay Processing Input* in the **System Information** dialog's **Causal Engine** tab. See [System Information: Causal Engine tab](#) and [Verify Current Status of a Device](#).

Status Color for Objects

NNMi displays the status color within [background shapes](#) on map objects that represent Nodes (devices) within your network.

The following table describes the meaning of each potential status color.

Background Shape's Status Color

Color	Meaning	Description
	Unknown	Indicates the object is unreachable and cannot be polled.
	Normal	Indicates there are no known problems related to the associated object.
	Warning	Indicates there might be a problem related to the associated object.
	Minor	Indicates NNMi detected problems related to the associated object that require further investigation.
	Major	Indicates NNMi detected problems related to the associated object to be resolved before they become critical.
	Critical	Indicates NNMi detected problems related to the associated object that require immediate attention.
	Disabled	Indicates the object is administratively <i>disabled</i> .
	No Status	Indicates one of the following: <ul style="list-style-type: none"> • NNMi's current configuration excludes this object from monitoring. The Status is not calculated because the object is set to Not Managed/Out Of Service/Scheduled Node Outage.

Background Shape's Status Color, continued

Color	Meaning	Description
		<ul style="list-style-type: none"> The object has just been added to the NNMi database and the Causal Engine has not yet calculated its health status.

Related Topics

"Status Color for Aggregator Objects (NNMi Advanced)" below

"Status Color for Network Connections" on page 89

Status Color for Aggregator Objects (*NNMi Advanced*)

Link Aggregation protocols enable network administrators to configure a *set of interfaces* on a switch to function as one. This technique of combining multiple interfaces increases bandwidth, the speed at which data travels, and provides redundancy.

Example Link Aggregation

Thick Line on Layer 2 Map =
 one Aggregator Layer 2 Connection

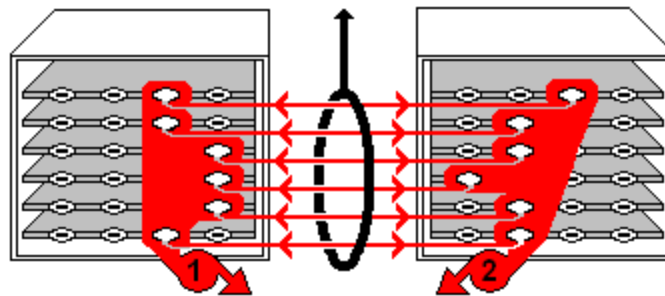

two Aggregator Interfaces:

- Logical units (not physical)
- Each functions as if it were one
- Each has 6 Aggregation Member Interfaces

On a Layer 2 map, a thick line with a superimposed ellipse represents a **Link Aggregation**¹ or **Split Link Aggregation**² (group of multiple Layer 2 Connections that are functioning as one). The icon representing an Interface at either end of the thick line is an Aggregator Interface (a *logical* interface comprised of many physical interfaces that are functioning as one).

Two endpoints:	Three endpoints:	More than three endpoints:
-----------------------	-------------------------	-----------------------------------

¹Protocols used on Switches to configure multiple Interfaces (Aggregation Member Interfaces) to function as if they were one (an Aggregator Interface). When two Aggregator Interfaces establish a connection, that connection is an Aggregator Layer 2 Connection. The Aggregator Layer 2 Connection appears on Layer 2 Neighbor View maps as a thick line with an Interface icon at each end (representing the Aggregator Interface).

²Link Aggregation with more than two endpoints. Some vendors refer to this as Multi-Chassis Link Aggregation, SLAG, MLAG, or MC-LAG.

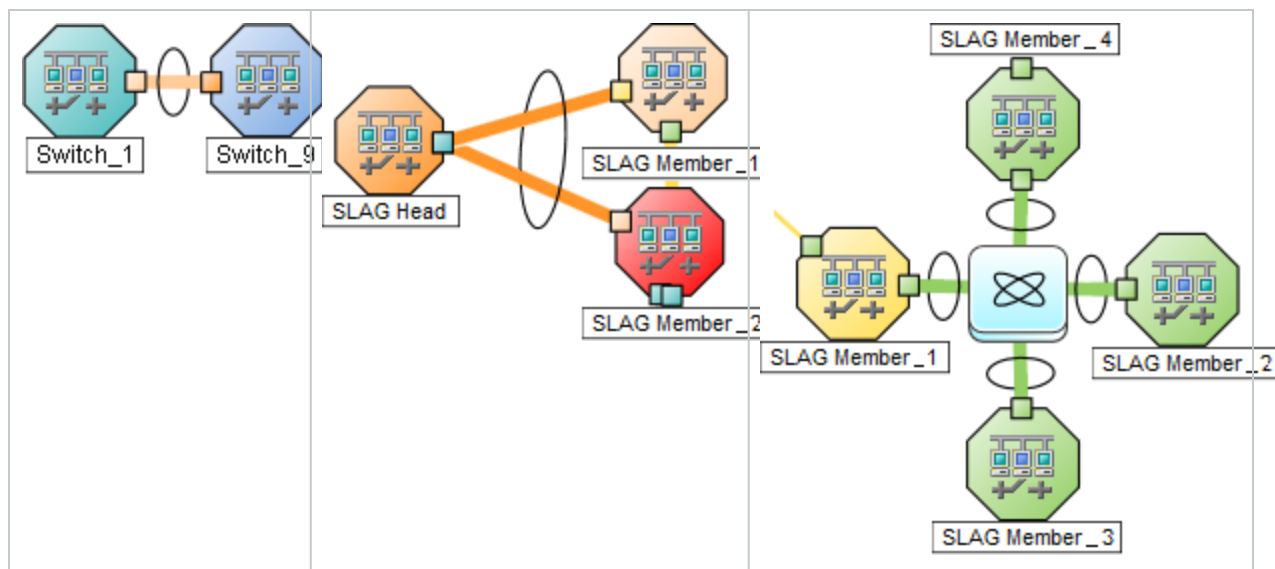

See "[Layer 2 Map Objects](#)" on page 99 for more information.

The following table describes the meaning of each potential status color for an Aggregator Interface.

Aggregator Interface Status Color

Color	Status	Meaning
	Unknown	Indicates all of the participating Aggregation Member Interfaces are unreachable and cannot be polled.
	Normal	Indicates all of the participating Aggregation Member Interfaces have a Status of Normal.
	Minor	Indicates at least one (but not all) of the participating Aggregation Member Interfaces has a Status of Critical.
	Critical	Indicates all of the participating Aggregation Member Interfaces have a Status of Critical.
	Disabled	Indicates all of the participating Aggregation Member Interfaces are administratively <i>disabled</i> .
	No Status	Indicates one of the following: <ul style="list-style-type: none"> • NNMi's current configuration excludes all of the participating Aggregation Member Interfaces from monitoring, so the Status is not calculated. For example, the entire device or the Aggregator Interface is set to Not Managed/Out Of Service/Scheduled Node Outage. • All of the participating Aggregation Member Interfaces have just been added to the NNMi database and the Causal Engine has not yet calculated their health status.

Related Topics

["Status Color for Objects" on page 86](#)

["Status Color for Network Connections" on the next page](#)

Status Color for Network Connections

Map lines indicate network connections. The color of these lines indicates current status. There are three types of lines on NNMi maps that indicate network communication paths:

- **Single connection** lines from one interface to another (network Layer 2 communications) or from one address to another (network Layer 3 communications).
- **Multiconnection** lines save space on complex NNMi maps. The NNMi administrator configures how many single connections dynamically condense into one thick line.
- **Aggregate connection** lines are thick lines with a superimposed ellipse representing a group of multiple connections that are functioning as one.

Single Connections

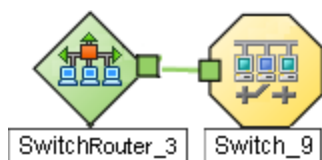

The following table describes the meaning of each potential status color for a single network connection.

Tip: Special icons within the line indicate additional information.

Network Connections Status Color

Color	Meaning	Description
	Unknown	Indicates that due to other network problems, the status of one interface cannot be determined at this time.
	Normal	Indicates both interfaces in the connection are responding.
	Warning	Indicates there might be a problem with either interface.
	Minor	Indicates the interface on one end is not responding. The interface on the other end is responding.
	Critical	Indicates neither interface or IP address is responding.
	Disabled	Indicates one or both interfaces are administratively <i>disabled</i> .
	No Status	Indicates one of the following: <ul style="list-style-type: none"> • NNMi's current configuration excludes one or both interfaces from monitoring. The Status is not calculated because the interface is set to Not Managed/Out Of Service. • The interface has just been added to the NNMi database and the Causal Engine has not yet calculated its health status.

Multiconnections

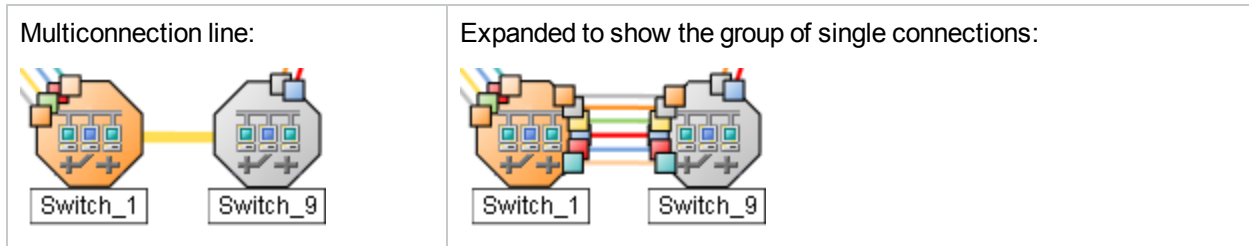

Note the following about **multiconnection**¹ lines:

- No Interface or IP address icon appears at either end of the thick line.
- To view the individual connections and the associated interfaces or IP addresses within a multiconnection, double-click the multiconnection line of interest.
- To collapse the expanded group of member connections, use the Refresh icon to refresh the map.
- To popup summary information about the multiconnection, move the mouse cursor over the multiconnection of interest.



The following table describes the meaning of each potential status color for a multiconnection line.

Multiconnections Status Color and Meaning

Color	Meaning	Description
	Unknown	Indicates that all connections in the multiconnection have a Status of Unknown.
	Normal	Indicates that all connections in the multiconnection have a Status of Normal.
	Warning	Indicates one of the following: <ul style="list-style-type: none"> • All connections in the multiconnection have a Status of Warning. • All connections in the multiconnection do not have the same Status and none of the connections have a Status of Major or Minor.
	Major	All connections but one in the multiconnection have a Status of Critical. One connection has a Status of either Normal, Warning, Minor, or Major.
	Minor	Indicates all connections but one in the multiconnection are Normal. The Status of one connection is Minor, Warning, or Critical.
	Critical	Indicates that all connections in the multiconnection have a Status of Critical.

¹A multiconnection is a thick line on a map view between two Node icons, two Node Group icons, or between a Node icon and a Node Group icon (with no Interface icon or IP Address icon at either end of the line). This thick line represents a set of multiple connections that have been combined to preserve space and simplify the map. Your NNMi administrator specifies the number of connections that must exist before NNMi condenses them into a multiconnection line (User Interface Configuration's Multiconnection Threshold attribute). Double-click the thick line to convert it into the original set of connections with Interface icons or IP Address icons at either end of the lines.

Multiconnections Status Color and Meaning, continued

Color	Meaning	Description
	Disabled	Indicates that all connections in the multiconnection have a Status of Disabled.
	No Status	Indicates that all connections in the multiconnection have a Status of No Status.

Aggregate Connections (NNMi Advanced)

Thick lines with a superimposed ellipse represent **Link Aggregation¹** or **Split Link Aggregation²** protocol usage (a group of multiple connections that are functioning as one). The icon representing an Interface at either end of the thick line is an Aggregator Interface (a *logical* interface comprised of many physical interfaces that are functioning as one).

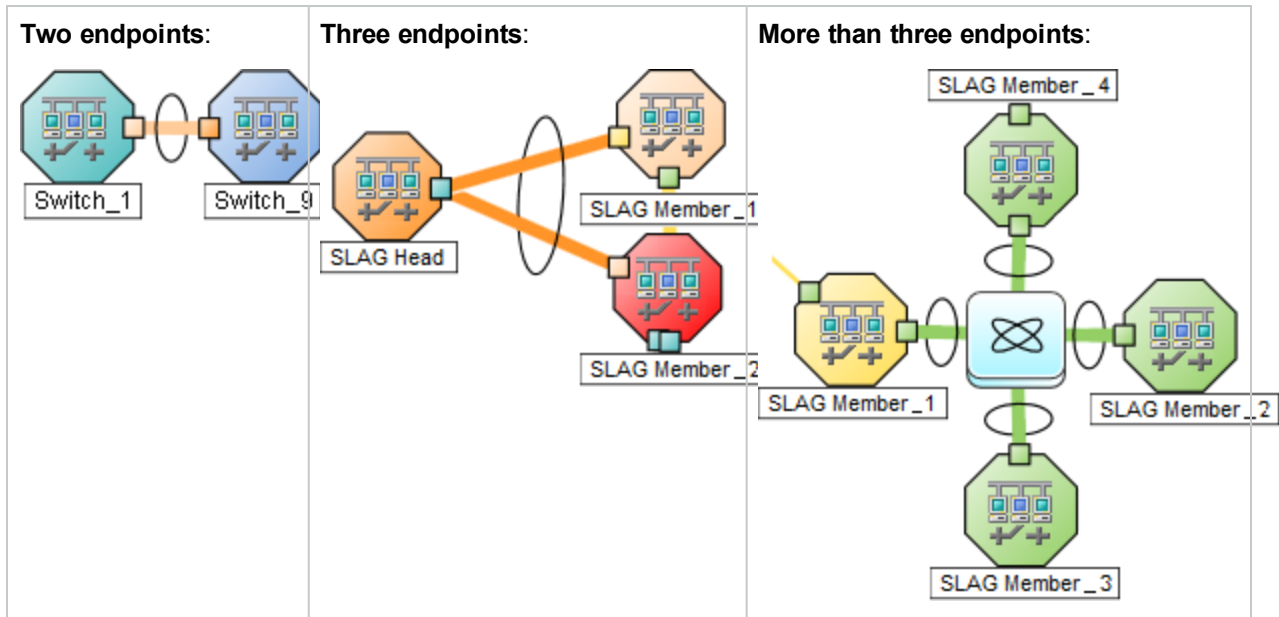







The following table describes the meaning of each potential status color for an Aggregator Layer 2 Connection. See "[Layer 2 Map Objects](#)" on page 99 for more information.

Aggregator Layer 2 Connection (thick line) Status Color

Color	Meaning	Description
	Unknown	Indicates all of the participating Aggregation Member Layer 2 Connections are unreachable and cannot be polled.

¹Protocols used on Switches to configure multiple Interfaces (Aggregation Member Interfaces) to function as if they were one (an Aggregator Interface). When two Aggregator Interfaces establish a connection, that connection is an Aggregator Layer 2 Connection. The Aggregator Layer 2 Connection appears on Layer 2 Neighbor View maps as a thick line with an Interface icon at each end (representing the Aggregator Interface).
²Link Aggregation with more than two endpoints. Some vendors refer to this as Multi-Chassis Link Aggregation, SLAG, MLAG, or MC-LAG.

Aggregator Layer 2 Connection (thick line) Status Color, continued

Color	Meaning	Description
	Normal	Indicates all of the participating Aggregation Member Layer 2 Connections have a Status of Normal.
	Minor	Indicates at least one (but not all) of the participating Aggregation Member Layer 2 Connections has a Status of Critical.
	Major	All connections but one of the participating Aggregation Member Layer 2 Connections has a Status of Critical. One connection has a Status of either Normal, Warning, Minor, or Major.
	Critical	Indicates all of the participating Aggregation Member Layer 2 Connections have a Status of Critical.
	Disabled	Indicates all of the participating Aggregation Member Layer 2 Connections are administratively down.
	No Status	Indicates one of the following: <ul style="list-style-type: none"> • NNMi's current configuration excludes all of the participating Aggregation Member Layer 2 Connections from monitoring, so the Status is not calculated. For example, the entire device or the Aggregator Interfaces on both ends of the connection are set to Not Managed/Out Of Service. • All of the Layer 2 Connections within the Aggregator Layer 2 Connection have just been added to the NNMi database and the Causal Engine has not yet calculated their health status.

Related Topics

["Status Color for Objects" on page 86](#)

["Status Color for Aggregator Objects \(NNMi Advanced\)" on page 87](#)

About Map Symbols

Map symbols convey the following information:

- The **background shape and foreground image** of map icons indicate the *type* of device being depicted.
- The lines between devices indicated network connections. **Special icons** within those lines indicate additional information.

For more information:

Background and Foreground



































Map symbols represent nodes or node groups. Each map symbol that represents a single node has a background shape and a superimposed foreground image (default images are shown in the table below). Custom foreground images might represent specific vendors and models.

Note: The NNMi administrator can customize the NNMi foreground image for each Device Profile. Therefore, you might see foreground images that are not described in the following table. Contact your



NNMi administrator if you have questions about any additional foreground shapes.

The color of the background shape indicates the most recent health status of the device (see "[Status Color for Objects](#)" on page 86 and "[Status Color for Aggregator Objects \(NNMi Advanced\)](#)" on page 87).

Background and Foreground Shapes for Specific Devices

Background Shape	Foreground Image \ Meaning	Background Shape	Foreground Image \ Meaning
	<p>Hypervisor (<i>NNMi Advanced</i>)</p> <p>The virtual machine manager in charge of delegating various aspects from a pool of resources to become virtual devices.</p> <p>When you double-click the hypervisor map icon, the displayed form includes a Hosted Nodes tab listing the virtual devices being provided.</p> <p>The virtual devices provided by the hypervisor have a Hosted On attribute that identifies which hypervisor provided the resources.</p>		<p> = Computer</p> <p> = Server</p> <p> = Workstation</p> <p> = Other</p> <p>Note: <i>Other</i> includes non-SNMP nodes.</p>
	<p> = ATM Switch</p> <p> = Switch</p> <p>Note: (<i>NNMi Advanced</i>) If the map object represents a <i>virtual</i> switch, double-click opens an Interface form (see Virtual Switch's Interface Form).</p>		<p> = Gateway</p> <p> = Hub</p> <p> = Router</p> <p> = Switch-Router</p> <p> = Voice Gateway</p>
	<p> = Chassis (visible when Multiple-Chassis device's icon is  expanded)</p>		<p>Multiple Chassis inside:</p> <p> = Computer</p> <p> = Server</p> <p> = Workstation</p>
	<p>Multiple Chassis inside:</p> <p> = Switch</p>		<p>Multiple Chassis inside:</p> <p> = Switch-Router</p>
	<p> = Analyzer</p> <p> = Firewall</p> <p> = Load Balancer</p> <p> = Network Appliance</p> <p> = Power Supply</p>		<p> = IP Phone</p>

Background and Foreground Shapes for Specific Devices, continued

Background Shape	Foreground Image \ Meaning	Background Shape	Foreground Image \ Meaning
	 = Printer  = Wireless Access Point		
	Child Node Group (no foreground image)		









Special Connections

The icons in the following table provide valuable information about certain connection lines between devices within your network. There are various types of communication channels within networks. The lines between map objects provide valuable information about both the type of connection and current health of that connection. See "[Status Color for Network Connections](#)" on page 89 for more information.



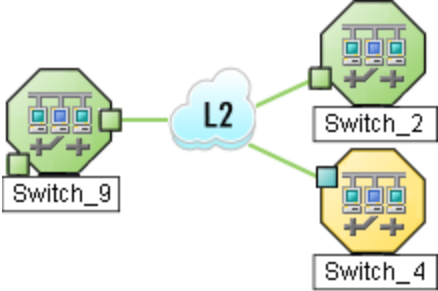



Tip: When you click a connection line, NNMi displays the port number at each end of the selected connection:

- Press **p** to toggle the port number off or on.
- Press **n** to toggle the device names off or on.

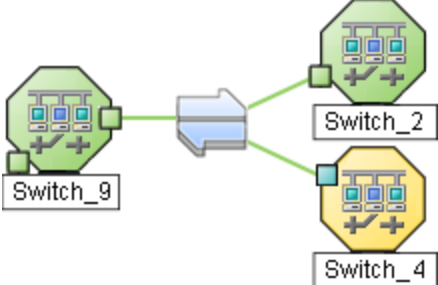
Icons for Special Connections

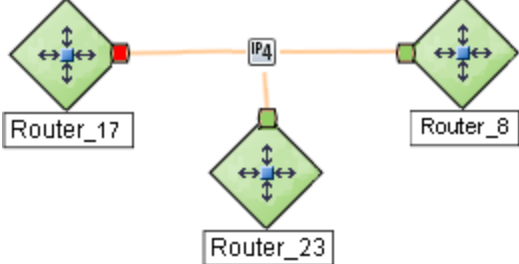

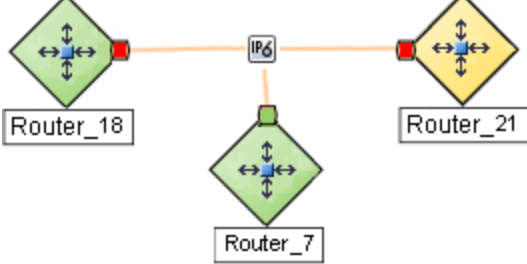







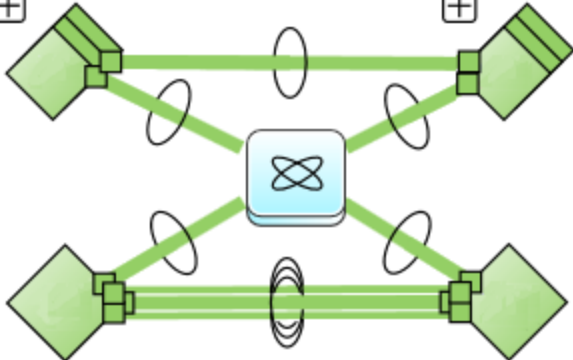

Icon	Meaning
	<p>Used in maps to represent Point-to-Multipoint (a connection with multiple interfaces) when NNMi detects a shared media, such as a hub or a mesh, connecting multiple devices. Click here for an example.</p> <p>If you double-click the line or the  (in prior NNMi releases the  icon or the  icon), the Layer 2 Connection Form displays and the Topology Source value is FDB.</p> 
	<p>Used in maps to represent Point-to-Multipoint (a connection with multiple interfaces) Layer 3 edge connectivity across wide-area-networks (WANs).</p> <p>The  icon (in prior NNMi releases the  icon) represents an unidentified set of devices between two nodes on the map (most likely a Service Provider's network or WAN). Click here for an example.</p>

Icons for Special Connections, continued

Icon	Meaning
	<p>NNMi accomplishes this by following special rules for subnets with prefix lengths between 28 and 31. These special rules are called Subnet Connection Rules. NNMi administrators can configure these rules.</p> <p>If you double-click the line or the  icon, the Layer 2 Connection Form displays and the Topology Source value is SUBNETCONNECTION.</p> 
	<p>Used in maps to represent IPv4 subnets. Click here for an example.</p> 
	<p>(<i>NNMi Advanced</i>) Used in maps to represent IPv6 subnets. Click here for an example.</p> 
	<p>(<i>NNMi Advanced</i>) In Layer 2 maps, a thick line with a superimposed ellipse represents Link Aggregation¹. See "Layer 2 Map Objects" on page 99.</p>



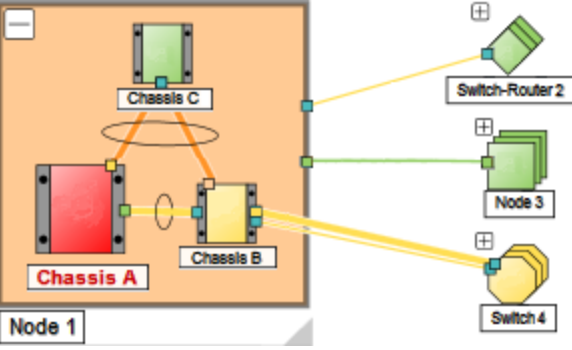

¹Protocols used on Switches to configure multiple Interfaces (Aggregation Member Interfaces) to function as if they were one (an Aggregator Interface). When two Aggregator Interfaces establish a connection, that connection is an Aggregator Layer 2 Connection. The Aggregator Layer 2 Connection appears on Layer 2 Neighbor View maps as a thick line with an Interface icon at each end (representing the Aggregator Interface).

Icons for Special Connections, continued

Icon	Meaning
	<p>(<i>NNMi Advanced</i>) In Layer 2 maps, the  icon, in combination with the superimposed ellipse indicates three or more endpoints participating in a Split Link Aggregation¹ (also known as SLAG mesh connection). See "Layer 2 Map Objects" on page 99.</p> 
  	<p>In Layer 2 maps, these icons indicate that the object contains more than one Chassis.</p> <ul style="list-style-type: none">  Click to display the entire group of  Chassis.  Click to close the expanded stack.  Click and drag to resize the expanded stack.  Save Map toolbar button. If your NNMi role allows, click to keep the Chassis visible when you return to that map in the future. <p>Lines within the expanded object convey special meaning:</p> <ul style="list-style-type: none"> Known Interface installed directly at device level.  Known Interface installed directly at Chassis level inside device.
<p>Node contains more than one chassis:</p> 	

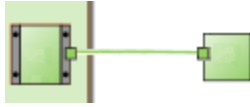
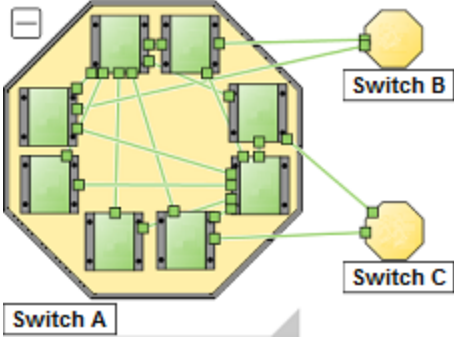
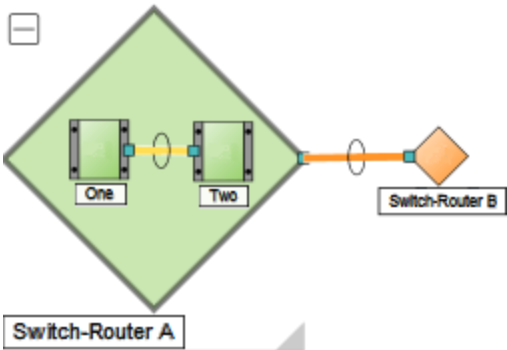

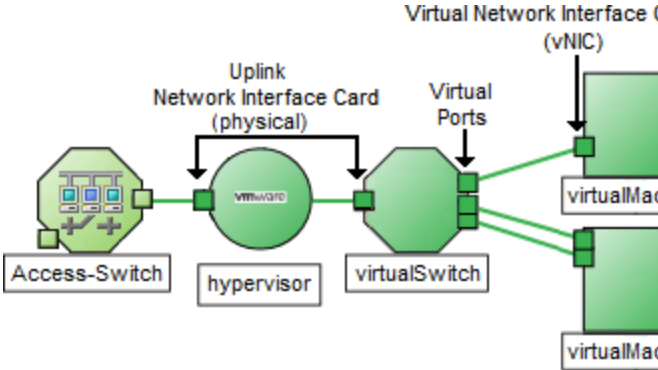

¹Link Aggregation with more than two endpoints. Some vendors refer to this as Multi-Chassis Link Aggregation, SLAG, MLAG, or MC-LAG.

Icons for Special Connections, continued

Icon	Meaning
	<p>Switch contains more than one Chassis.</p>  <p>Switch-Router contains more than one Chassis.</p> 
	<p>(<i>NNMi Advanced</i>) In Layer 2 maps, this icon represents the hypervisor¹ (virtual machine manager) in charge of delegating various aspects from a pool of resources to become virtual devices.</p> <p>Here is one example:</p> 
	<p>Used in Path Views if NNMi detects a connection, but cannot verify the device's identification (no response to SNMP), that device is indicated on the map by a the  (in prior NNMi</p>

¹The virtual machine manager in charge of delegating various aspects from a pool of resources to become virtual devices. The delegations might be static or dynamic, depending on the manufacture's implementation. The type of virtual machines being generated depends on the manufacturer's implementation.

Icons for Special Connections, continued

Icon	Meaning
	<p>releases the  icon) cloud symbol.</p> <p style="text-align: center;">Click here for an example.</p>  <p>Note: In Path View maps, a black arrow or empty black circle indicates that NNMi was not able to determine a status value because the connection or interface is not in the NNMi database.</p> <p>For more information, see "Path View Map Objects" on page 104.</p>
	<p>(<i>NNMi Advanced</i>, plus <i>HPE Route Analytics Management System (RAMS) for MPLS WAN</i>) Used in RAMS MPLS WAN Map views. If NNMi detects an MPLS connection across the network, it is indicated on the map by a cloud symbol. Click here for an example.</p>  <p>If you are an NNMi administrator, also see HPE RAMS MPLS WAN Configuration (NNMi Advanced) for more information.</p>

Related Topics

["Working with Objects" on page 169](#)

Node Group Map Objects

Tip: See "Help for Operators" for more information about Node Group maps.

Node Group maps show members of a Node Group (as defined by the NNMi administrator). Each Node Group Map shows either Layer 2 or Layer 3 information.

The map displays the status of each member, connection, and Child Node Group. To provide context for your environment, the NNMi administrator might also add a background image (for example, a map of North America).

NNMi can enlarge the map symbol of any node associated with a **Key Incident**¹. Use the **Indicate Key Incidents** button in the map view toolbar (see [Using the View Toolbars: Node Group Map Toolbar Icons](#)):

¹Incidents with both: (1) Severity = other than Normal. (2) Correlation Nature = equal to Root Cause, Service Impact, Stream Correlation, Rate Stream Correlation, Info, or None.



(on) = When the this Node Group map opens, NNMi enlarges any objects on a Node Group map that are Source Objects for a **Key Incident**¹. (For example, when viewing the Node Group map, NNMi enlarges any node on a Node Group map that has an open root cause incident associated with it.)



(off) = When the this Node Group map opens, NNMi does not indicate the objects on a Node Group map that are Source Objects for a **Key Incident**².

To view the associated incident for the node, double-click the node symbol. In the Node form, select the Incidents tab.

Because these maps are based on Node Groups rather than connectivity, some nodes might not have any connections on the map.

A hexagon (as shown below) indicates a Child Node Group:



A gray halo around a map icon indicates a device that is one-hop outside of the displayed Node Group (connected to a Node Group member, but not itself a member). Not all one-hop neighbors are displayed. Your NNMi administrator must configure the Node Group map to show one-hop neighbors if those neighbors are members of the particular Node Group used as the filter.

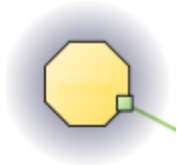

See "[Views Available in NNMi](#)" on page 24 for information about the Node Group maps that NNMi provides.

Related Topics

["About Map Symbols" on page 92](#)

["About Status Colors" on page 85](#)

["About Workspaces" on page 19](#)

Layer 2 Map Objects

Layer 2 maps show a map view of a selected device and any connected devices within a specified number of hops from the selected device. This is useful for understanding the **switch connectivity** between devices. See "Help for Operators" for more information.

During discovery, NNMi reads the Forwarding Database (FDB) tables from Ethernet switches within a network to help NNMi determine communication paths between network devices. NNMi searches these FDB

¹Incidents with both: (1) Severity = other than Normal. (2) Correlation Nature = equal to Root Cause, Service Impact, Stream Correlation, Rate Stream Correlation, Info, or None.

²Incidents with both: (1) Severity = other than Normal. (2) Correlation Nature = equal to Root Cause, Service Impact, Stream Correlation, Rate Stream Correlation, Info, or None.

tables for information about discovered nodes. When an NNMi management server finds FDB references to duplicate **MAC addresses**¹:

- If two or more discovered nodes contain an interface associated with the same Media Access Control (MAC) address within the same Tenant or with one of those nodes in Default Tenant and one in any other Tenant, NNMi disregards the communication paths reported for those duplicate MAC addresses in the FDB. This might result in missing connections on NNMi maps in network areas that include those duplicate MAC addresses.

(NNMi Advanced - Global Network Management feature) If two NNMi management servers discover nodes that contain an interface associated with the same Media Access Control (MAC) address, the Global NNMi management server's maps could be missing connections that are visible on the Regional NNMi management server's maps.

- If a single node contains multiple interfaces that have the same MAC address, NNMi gathers all communication path information for those interfaces and displays that information on NNMi maps.

Forwarding Database (FDB) information can cause NNMi to establish wrong Layer 2 Connections in the following cases:

- When the FDB is configured as cache and contains obsolete data.
- In network environments with hardware from a variety of vendors, when each vendor generates different and sometimes conflicting FDB data.

Optional: NNMi administrators can configure Spiral Discovery to ignore the FDB data from one Node Group when calculating Layer 2 Connections (the FDB data is still included in other calculations).

For example, in Layer 2 Neighbor View maps, interfaces are indicated by little squares around the background shape of the parent node. Each interface also has a status color. Green indicates the interface is working properly. Red indicates the interface is down.

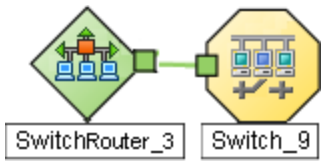
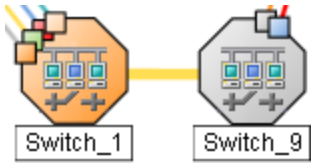
Connection Lines	Meaning of Connection Line
	Thin lines between devices indicate communication channels between the two devices (connections). The lines also show status color indicating the current health of that connection. See " Status Color for Objects " on page 86.
	A thick line that does not have any interface icon at both ends is a multiconnection ² . Double-click the thick line to expand the group of individual links.





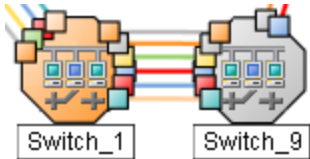
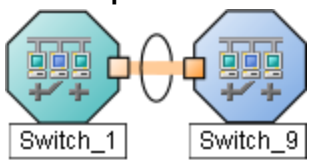
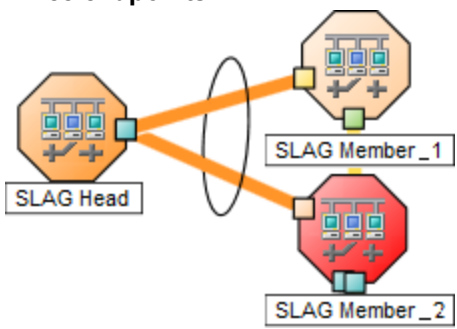



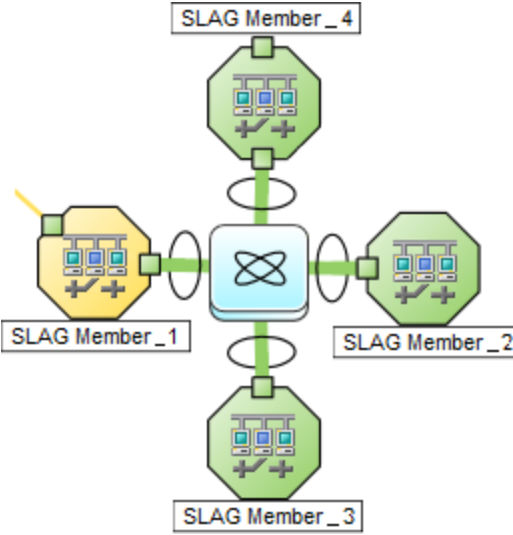

¹The Media Access Control address (hardware address or physical address) that the factory burns into a network adapter or device with built-in networking capability. A MAC address has six pairs of hexadecimal digits, separated by colons or dashes. For example 02:1F:33:16:BC:55

²A multiconnection is a thick line on a map view between two Node icons, two Node Group icons, or between a Node icon and a Node Group icon (with no Interface icon or IP Address icon at either end of the line). This thick line represents a set of multiple connections that have been combined to preserve space and simplify the map. Your NNMi administrator specifies the number of connections that must exist before NNMi condenses them into a multiconnection line (User Interface Configuration's Multiconnection Threshold attribute). Double-click the thick line to convert it into the original set of connections with Interface icons or IP Address icons at either end of the lines.

Connection Lines	Meaning of Connection Line
<p>Expanded Connection:</p> 	
<p>Two endpoints:</p>  <p>Three endpoints:</p>  <p>More than three endpoints:</p>	<p>(<i>NNMi Advanced</i>) Thick lines (connections) with an ellipse around them indicate Link Aggregation¹ protocols are in use. These protocols enable network administrators to configure a set of interfaces on a switch as one Aggregator Interface, creating an Aggregator Layer 2 Connection to another device using multiple interfaces in parallel to increase bandwidth, increase the speed at which data travels, and increase redundancy.</p> <p>Double-click the thick line (the Aggregator Layer 2 Connection) to open the Layer 2 Connection form for more information.</p> <p>NNMi calculates the status of the thick line (Aggregator Layer 2 Connection) based on the status of the entire group of Aggregation Member Layer 2 Connections. See "Status Color for Aggregator Objects (NNMi Advanced)" on page 87 for more information.</p> <p>When the link aggregation has more than two endpoints, NNMi depicts the link as a Split Link Aggregation² (SLAG) group of links.</p>

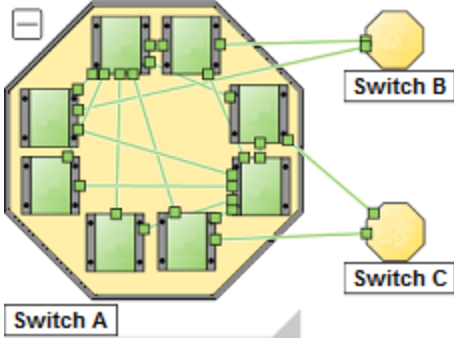
¹Protocols used on Switches to configure multiple Interfaces (Aggregation Member Interfaces) to function as if they were one (an Aggregator Interface). When two Aggregator Interfaces establish a connection, that connection is an Aggregator Layer 2 Connection. The Aggregator Layer 2 Connection appears on Layer 2 Neighbor View maps as a thick line with an Interface icon at each end (representing the Aggregator Interface).

²Link Aggregation with more than two endpoints. Some vendors refer to this as Multi-Chassis Link Aggregation, SLAG, MLAG, or MC-LAG.

Connection Lines	Meaning of Connection Line
	
<p>Node: </p> <p>Switch: </p> <p>Switch-Router: </p>	<p>These icons indicate that the device contains more than one  Chassis.</p> <ul style="list-style-type: none"> Click  to display the entire group of Chassis. For example:  <ul style="list-style-type: none"> Click  to close the expanded stack. Click  and drag to resize the expanded stack. If your NNMi role allows, click the  Save Map toolbar button to keep the Chassis visible when you return to that map in the future.
<p>Hypervisor (NNMi Advanced): </p>	<p>In Layer 2 maps, this icon represents the virtual machine manager in charge of delegating various aspects from a pool of resources to become virtual devices.</p>

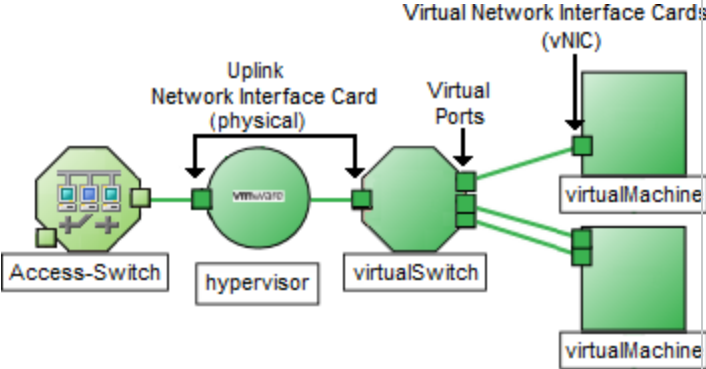
Connection Lines	Meaning of Connection Line
	Here is one example of a hypervisor ¹ :  <p>The diagram illustrates a network path starting from an Access-Switch on the left, which connects to a Uplink Network Interface Card (physical) within a hypervisor (labeled 'vmware'). From the hypervisor, the connection goes to a virtualSwitch, which then connects to two virtualMachines via Virtual Ports and Virtual Network Interface Cards (vNIC).</p>

See "Help for Operators" for more information about Layer 2 maps.

Related Topics

- ["About Map Symbols" on page 92](#)
- ["About Status Colors" on page 85](#)
- ["About Workspaces" on page 19](#)

Layer 3 Map Objects

Layer 3 maps show a selected device and its connected devices within a specified number of hops from the selected device. This view is useful for understanding the **router connectivity** between devices.

For example, in Layer 3 Neighbor View maps, addresses connected to neighbors within the same subnet are indicated by hexagons around the background shape of the parent node. Each address has a status color. Green indicates the address is working properly. Red indicates the address is not responding. The line between devices indicates the subnet. The subnet does not have any status:

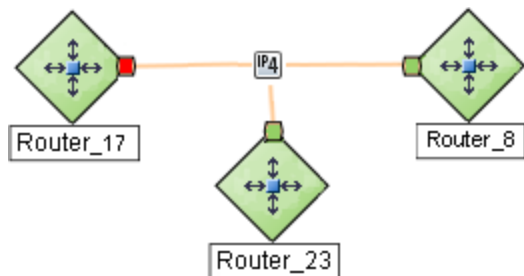

(NMMi Advanced) IPv6 subnets are indicated by this symbol:

¹The virtual machine manager in charge of delegating various aspects from a pool of resources to become virtual devices. The delegations might be static or dynamic, depending on the manufacturer's implementation. The type of virtual machines being generated depends on the manufacturer's implementation.

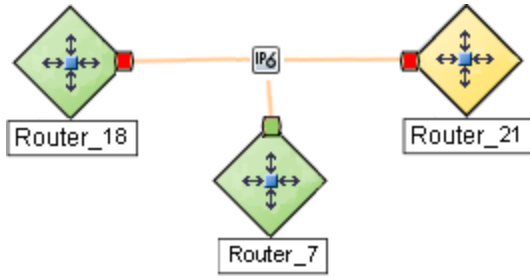

See "Help for Operators" for more information about Layer 3 Neighbor View maps.

Related Topics

["About Map Symbols" on page 92](#)

["About Status Colors" on page 85](#)

["About Workspaces" on page 19](#)

Path View Map Objects

Path View maps show an active network path between a source and destination end point.

The main objects in the displayed path in a Path View map are routers and switches.

Caution: Do not specify a switch as a Source or Destination node in Path View maps. To view connectivity between switches, use the Layer 2 Neighbor View.

When NNMi cannot determine the nodes within a portion of the path, it uses a Cloud object as shown in the example below:

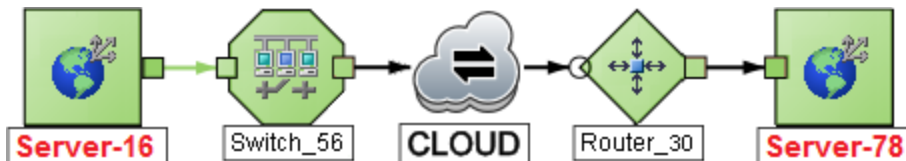

If a black arrow \rightarrow or empty black circle $\rightarrow \bigcirc$ appears at the end of the connection in Path View maps, NNMi was not able to determine a status value because the connection or interface is not in the NNMi database. [Click here](#) for more information.

Reasons a connection or interface are not stored in the NNMi database, include the following:

- NNMi is unable to collect information about a node in the path because it is a non-SNMP node.
- A node in the path is not managed by NNMi.
- The discovery information for a node is not up-to-date (for example, interface information is missing).

Path View maps also show objects included in Layer 2 Neighbor View maps and Layer 3 Neighbor View maps. See "Help for Operators" for more information.

(NNMi Advanced) Path View works only with IPv4 addresses. The NNMi Advanced IPv6 address values are not valid choices for Path View. Any devices in your network that are configured with IPv6 addresses cannot be displayed on Path View maps.

(NNMi Advanced) If your network administrator configures NNMi to gather data from Router Redundancy Groups that have more than one Active router, NNMi selects one Active router for the path. To indicate there

is more than one *possible path*, NNMi connects any additional routers to the Active router as shown in the example below:

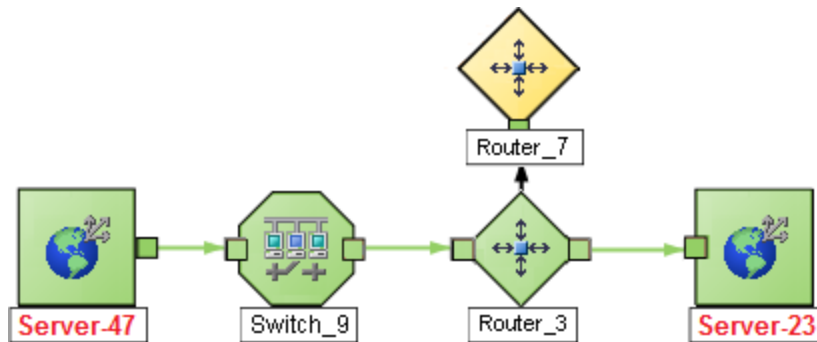

(*NNMi Advanced*), plus *HPE Route Analytics Management System (RAMS) for MPLS WAN*) If your network administrator configures NNMi to gather data from Route Analytics Management System (RAMS), the Path View can show multiple **OSPF**¹ Equal Cost paths through a Layer 3 cloud as shown in the example below:

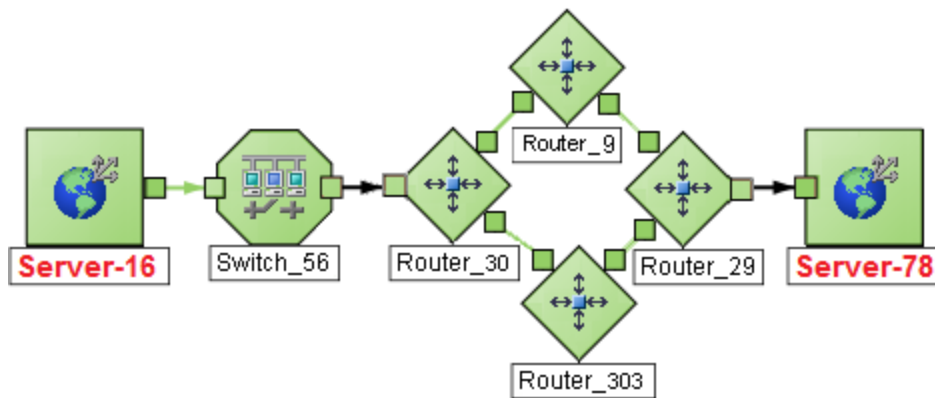

If you are an NNMi administrator, see [HPE RAMS MPLS WAN Configuration \(NNMi Advanced\)](#) for information about configuring RAMS.

Related Topics:

["About Map Symbols" on page 92](#)

["About Status Colors" on page 85](#)

["About Workspaces" on page 19](#)

Navigate Maps

NNMi enables you to navigate within map views in the following ways:

["Change the Map Layout" on the next page](#)

[Toggle Map Object's Label Text](#)

["Adjust the Zoom Factor" on page 109](#)

["Pan Around the Map" on page 110](#)

["Set the Location of the Overview Pane" on page 111](#)

¹Open Shortest Path First Protocol

["Find a Node in a Map" on page 112](#)

Change the Map Layout

If you prefer a different layout for the symbols on your map, you can change the placement (see ["About Map Symbols" on page 92](#)):

- **To make quick changes:**

- n** to toggle node labels on/off

- p** to toggle port labels on/off

- **To display the  Chassis icons associated with a device:**

Devices with more than one Chassis are indicated by the following icons:



- Click  to display the entire group of Chassis within a device. NNMi adjusts the layout of the entire map to make room for the expanded map icon. For example:

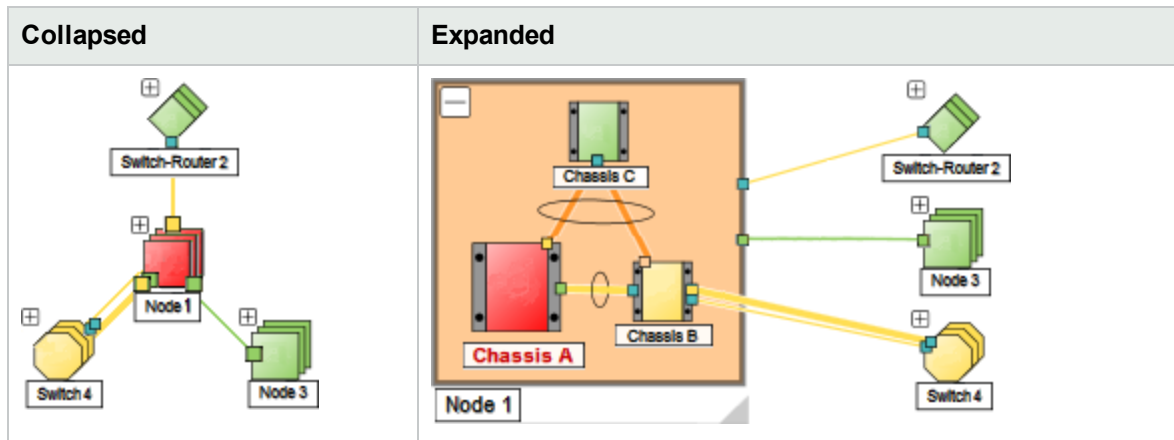

- Click the  icon and drag to resize the expanded device icon.

- Click the  icon to collapse the expanded device icon.

Tip: To return the map to its prior layout, click the [Workspace: View](#) link for that map. NNMi draws a fresh rendering in the layout last  Saved by an NNMi user (all NNMi users share the same version of the map).

- **To move a single object:**

Left-click and drag any map symbol to the location you want on the map.

To deselect the object, either click on the map background or use Ctrl + Left-Click.

- **To move multiple objects:**

Do any of the following:

- Shift+Left-Click the mouse in an empty space between nodes and drag the cursor over the area of the map you want to select. When you use this method, NNMi indicates the selection area using a dotted line (or rubber band) as shown in the following example:

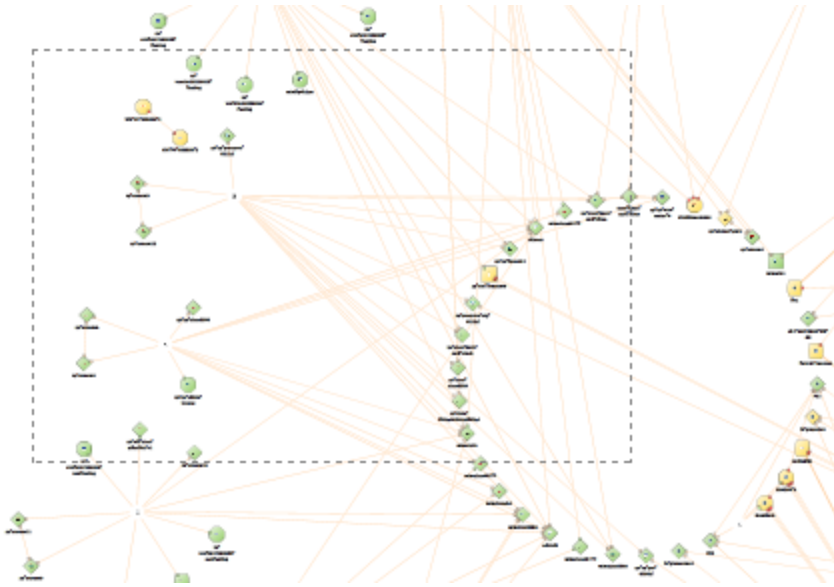

- Use Ctrl+Left-Click to select or deselect each object of interest on the map.
Each object you select changes to indicate it has been selected. Drag any one of the selected nodes to move the group of objects to the location you want on the map.

Tip: If you drag using space between the nodes, all objects are deselected.

This placement persists until you refresh or otherwise reload the map.

Node Group Maps only: If your role permits, click the  **Save Map** toolbar button to keep the new layout visible on that map in the future. Once a map is saved, newly discovered devices appear in the bottom left corner of the map.

Note: Each time you select  **Save Map**, NNMi deletes any previous node location information for the map. All team members see the changes.

- **Virtual devices (NNMi Advanced):**

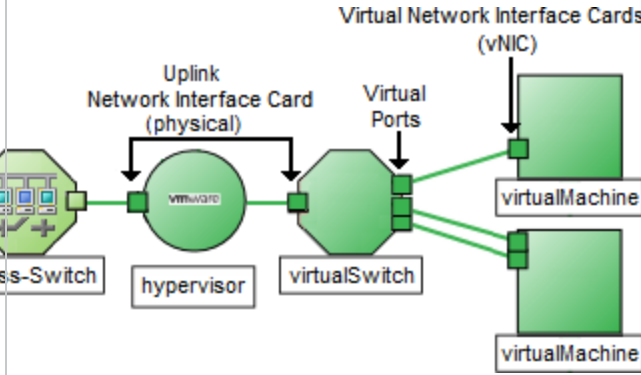
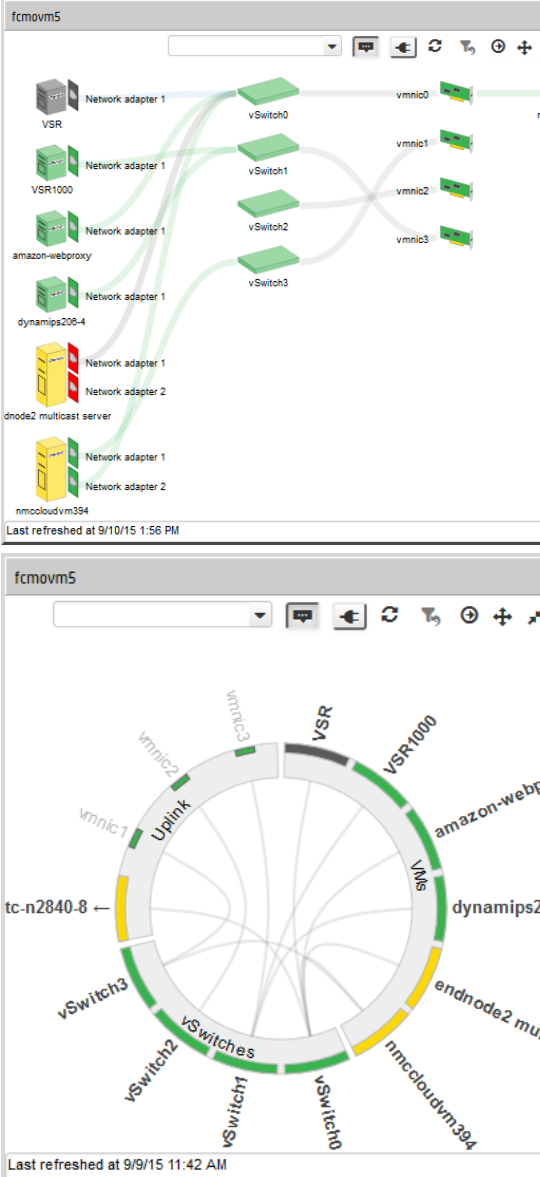
L2 Map	Wheel Dialog
 <p data-bbox="237 688 771 814">To display information about one Hypervisor's resources, right-click any object representing a hypervisor, virtual machine, or component of a hypervisor (such as Interface), and then select:</p> <p data-bbox="237 835 836 898">Hypervisor > Hypervisor Wheel ("Using the Wheel Dialog" on page 117)</p> <p data-bbox="237 909 820 972">Hypervisor > Hypervisor Loom ("Using the Loom Dialog" on page 136)</p>	

Related Topics

- "Toggle Map Object's Label Text" on the next page
- "Adjust the Zoom Factor" on the next page
- "Pan Around the Map" on page 110
- "Set the Location of the Overview Pane" on page 111
- "Find a Node in a Map" on page 112

Toggle Map Object's Label Text

Press **n** to show/hide object names on the map.

Press **p** to show/hide Port names at the end of connection lines.

Related Topics

["Change the Map Layout" on page 106](#)

["Adjust the Zoom Factor" below](#)

["Pan Around the Map" on the next page](#)

["Set the Location of the Overview Pane" on page 111](#)

["Find a Node in a Map" on page 112](#)

Adjust the Zoom Factor

You can adjust the zoom factor in a map in several ways.

- **To zoom-in a map:**

Do one of the following:

- Rotate the mouse wheel button forward.
- Click .
- Press **+** (PLUS SIGN).
- In the Overview Pane, double-click the Focus Area that is indicated with the blue rectangle as shown in the following example:

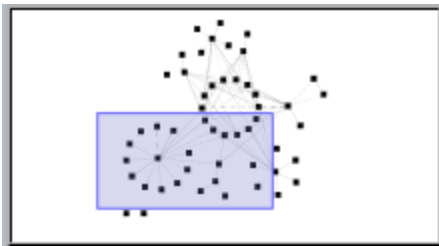



Note: If NNMi does not indicate a Focus Area, double-click anywhere in the Overview Pane.

The Overview Pane provides a view of the entire map you selected. The Focus Area indicates the portion of the map that NNMi displays in the larger map view.

Tip: See ["Set the Location of the Overview Pane" on page 111](#).

- **To zoom-out a map:**

Do one of the following:

- Rotate the mouse wheel button backward.
- Click .
- Press - (minus sign).
- In the Overview Pane, double-click outside the Focus Area that is indicated with the blue rectangle.
- **To fit the entire map to the screen size:**
Do one of the following:
 - Click .
 - Press = (equal sign).
- **To display the map at 100 percent (actual size device images):**
Do one of the following:
 - Click .
 - Press 1 (ONE).

Related Topics

["Change the Map Layout" on page 106](#)

["Toggle Map Object's Label Text" on the previous page](#)

["Pan Around the Map" below](#)

["Set the Location of the Overview Pane" on the next page](#)

["Find a Node in a Map" on page 112](#)

Pan Around the Map

If the node of interest is not easily visible on the map, you can move to other sections of the map.

To pan to other sections of the map:

Do one of the following:

- Press the arrow keys to move the map around (↑ up arrow, ↓ down arrow, → right arrow, ← left arrow).
- Left-click the background and use the mouse to drag to a new location.
- Press Ctrl + Left-Click to pan around the map.
- The Overview Pane provides a view of the entire map.

NNMi indicates the Focus Area using a light-blue rectangle as shown in the following example:

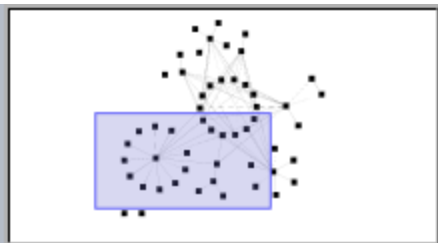

Tip: See ["Set the Location of the Overview Pane"](#) below.

- Drag the Focus Area to pan around the map.
- Double click inside the Focus Area to zoom in.
- Double click outside the Focus Area to zoom out.

Related Topics

["Change the Map Layout"](#) on page 106

["Toggle Map Object's Label Text"](#) on page 109

["Adjust the Zoom Factor"](#) on page 109

["Set the Location of the Overview Pane"](#) below

["Find a Node in a Map"](#) on the next page

Set the Location of the Overview Pane

You can choose which corner of the map contains the Overview Pane:

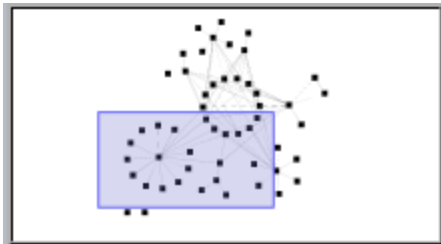

Alternatively, you can hide the Overview Pane .

To set the location of the Overview Pane:

1. In the Map toolbar, toggle the Overview Location button on:



2. In the menu, select one of locations

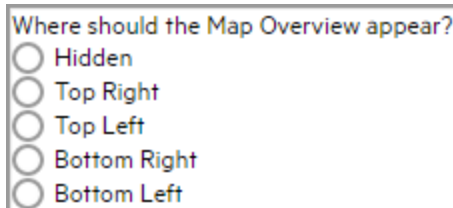

3. To close the menu, toggle the Overview Location button off:



Related Topics

["Change the Map Layout"](#) on page 106

["Toggle Map Object's Label Text"](#) on page 109

["Adjust the Zoom Factor"](#) on page 109

["Pan Around the Map" on page 110](#)

["Find a Node in a Map" below](#)

Find a Node in a Map

You can easily find a particular Node in a map.

To find a Node in the current map:

1. In the Map toolbar, toggle the Find button on:



2. In the text box , do one of the following:

- Click the  drop-down icon to display the complete list of choices within this map. Select any item from the list.
- Type the Name attribute value (*not case-sensitive*) of the Node you want to find in the map. This is the Name attribute value from the [Node form](#), that becomes the map icon label.

As you type, the auto-complete feature displays a list of possible matches. Select any item from the list.

3. NNMi selects the Node that has a Name attribute value that matches your choice. If necessary, NNMi pans to the appropriate area in the Map.
4. To navigate elsewhere in the map, toggle the Find button off:



Related Topics

["Change the Map Layout" on page 106](#)

["Toggle Map Object's Label Text" on page 109](#)

["Adjust the Zoom Factor" on page 109](#)

["Pan Around the Map" on page 110](#)

["Set the Location of the Overview Pane" on the previous page](#)

Refresh Node Status on a Map

In map views, you can refresh the node status on a map while maintaining the layout of the nodes. This feature enables you to quickly refresh a view when you are only concerned with status updates for one or more nodes on your map.

NNMi automatically refreshes node status on a map every 60 seconds. The refresh counter begins after the completion of the last status refresh.

Note: If a map is taking longer than expected to refresh, the maximum number of nodes that are displayed on a map might be set too high. The NNMi administrator can set this value. See "Help for Administrators" for more information.

You can refresh the node status manually.

To refresh only the node status:

Click the  **Refresh Status** icon in the toolbar to manually refresh node status on your map view.

The last update time is changed and the status of each node is refreshed on the map. Nodes are not added, deleted, or rearranged. Connectivity is not recalculated.

Note: Some NNMi users can delete nodes and other objects from the NNMi database (depending on the assigned NNMi Role). Any node that has been deleted appears as a transparent icon to all NNMi users until their map is refreshed using the  **Refresh** icon. After **Refresh**, the deleted node is removed from the map. NNMi does not automatically refresh the connectivity or set of nodes in a map view, except on the **Initial Discovery Progress** and **Network Overview** maps.

Related Topics

["Using the View Toolbars" on page 159](#)

["Refresh a View" on page 58](#)

Control Tool Tips Information on a Map

When you place the mouse cursor over an object on a map, NNMi displays Tool Tips information for the current object. Tool Tips information is a subset of the information contained in the object's form.

Each time you open a map, the  **Tool Tips** button is enabled.

To disable Tool Tips popups, click the  **Tool Tips** button. NNMi closes any open Tool Tip dialog boxes.

Related Topics

["Using the View Toolbars" on page 159](#)

Access Maps Provided by NNMi

You can access maps in the following ways:

- From table views using the **Actions** menu
- From the  Topology Maps and  Troubleshooting workspaces

Table Views

To display a map view from a table view:

See ["Using Actions to Perform Tasks" on page 173](#) for more information about using the **Actions** menu.

1. Select the table view you want from the workspaces navigation panel. (For example, select the **Inventory** workspace, **Nodes** view.)
2. In the table view, click the row that contains the object of interest.
3. Select the **Actions** menu in the main toolbar and select the map view you want.



Note: You can also access map views from the **Actions** menu in a form. See ["About the NNMi Console" on page 1](#), for more information.

Tip: You can also right-click any object in a table or map view to access the items available within the **Actions** menu.



The label for the starting node appears in bold text on the map.

4. If you are displaying either Layer 2 or Layer 3 Neighbor View maps, after the map view appears, you can change the number of **hops**¹.

In the **Number of Hops** drop-down list, select the number of hops to display. The default number of hops is 1. The maximum number of hops is 9.

Topology Maps Workspace

To display a Node Group map:

1. Select the  **Topology Maps** workspace.
2. Click  to expand the folder of interest.
3. Select the name of the Node Group map you want to view.

Troubleshooting Workspace

- To display a Layer 2 or Layer 3 Neighbor View map:
 - a. Select the  **Troubleshooting** workspace.
 - b. Select the type of map you want to generate.
 - c. In Layer 2 Neighbor View and Layer 3 Neighbor View maps, you can designate the starting node using either the node name or IP address. The label for the starting node appears in bold text on the map.

Note: After you begin to type the node name or IP address, NNMi displays a list that includes all potential existing names or IP addresses that match the letters or numbers as you enter them.

- d. After the map view appears, you can change the number of **hops**².
In the **Number of Hops** drop-down list, select the number of hops to display. The default number of hops is 1. The maximum number of hops is 9.

¹A hop is a node representing any network device, such as a workstation, gateway, or switch, which is connected by a link with no intermediate nodes.

²A hop is a node representing any network device, such as a workstation, gateway, or switch, which is connected by a link with no intermediate nodes.

- To display a Path View:
 - a. Select the  **Troubleshooting** workspace.
 - b. Select **Path View**.
 - c. In the **Source** and **Destination** fields, designate the nodes at both ends of the path using either the node name or IPv4 address.

Note: After you begin to type the node name or IPv4 address, NNMi displays a list that includes all potential existing names or IPv4 addresses that match the letters or numbers as you enter them.

(*NNMi Advanced*) Path View works only with IPv4 addresses. The NNMi Advanced IPv6 address values are not valid choices for Path View. Any devices in your network that are configured with IPv6 addresses cannot be displayed on Path View maps.

- To display a Node Group map:
 - a. Select the  **Troubleshooting** workspace.
 - b. Select **Node Group Map**.
 - c. In the Node Group field, specify the name of the Node Group that contains the nodes you want to display.

Note: After you begin to type the Node Group name, NNMi displays a list that includes all potential existing names (case-sensitive) that match the letters or numbers as you enter them.

Chapter 7: Using Hypervisor Diagrams and Dialogs

(*NNMi Advanced*) NNMi provides two types of interactive diagrams that show detailed information about virtual objects offered by a particular **hypervisor**¹. These diagrams are available on tabs in the Analysis Pane and available within interactive popup dialogs when the hypervisor or one of its virtual devices is selected:

Wheel Dialog (displaying the wheel diagram)

See "Using the Wheel Dialog" on the next page.

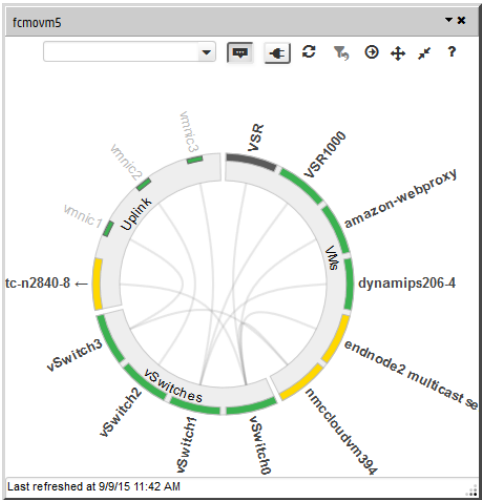

Loom Dialog (displaying the loom diagram)

See "Using the Loom Dialog" on page 136.

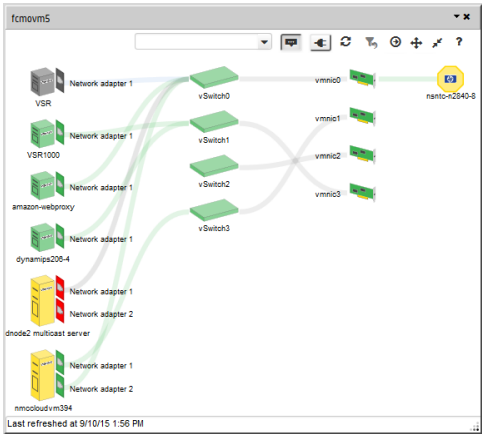





Accessing Hypervisor Dialogs

The dialogs can be accessed in a variety of ways.

Access Point	Procedure
Map Views Table Views	<p>For any object representing a hypervisor, virtual machine, or other component of a hypervisor (such as Node, Interface, or related Incident), do one of the following to launch the dialog:</p> <p>Right-click the object:</p> <ul style="list-style-type: none"> • Hypervisor > Hypervisor Wheel dialog • Hypervisor > Hypervisor Loom dialog

¹The virtual machine manager in charge of delegating various aspects from a pool of resources to become virtual devices. The delegations might be static or dynamic, depending on the manufacture's implementation. The type of virtual machines being generated depends on the manufacturer's implementation.

Access Point	Procedure
	Select the object and then use the Actions menu: <ul style="list-style-type: none"> • Actions > Hypervisor > Hypervisor Wheel dialog • Actions > Hypervisor > Hypervisor Loom dialog
Analysis pane and Dashboard view for: Node Interface Incident	Select a hypervisor, virtual machine (VM), Virtual Switch (vSwitch), or other component being provided by a hypervisor, and then navigate to the Analysis pane or Dashboard view. Select one of the following Analysis Pane tab or Dashboard panel: <ul style="list-style-type: none"> • Wheel Diagram • Loom Diagram Only a limited number of Wheel Dialog and Loom Dialog features are available within the Analysis pane and Dashboard panel. For access to all available features: Click  Show Diagram in New Window in the Analysis pane.
Docked dialog:	When you click the  Dock icon (in the dialog title bar), the dialog popup collapses into a small rectangular link at the bottom of the Analysis Pane's tab space. Click the link to display the dialog. <div style="display: flex; justify-content: space-around; align-items: center;"> <div style="text-align: center;">  hypervisor name = Wheel Dialog </div> <div style="text-align: center;">  hypervisor name = Loom Dialog </div> </div>
<p>Tip: Your NNMi administrator can display the Wheel and Loom outside of NNMi using <code>showWheel</code> and <code>showLoom</code> commands with special URLs to provide detailed information about a particular hypervisor or one of the resources being provided by that hypervisor.</p>	

Using the Wheel Dialog

(NNMi Advanced) The Wheel Dialog shows the current deployment of virtual resources:

Slide 1: The initial display shows the entire set of virtual nodes currently being deployed by the **hypervisor**¹ (any resources that are currently Powered Off are not displayed):

¹The virtual machine manager in charge of delegating various aspects from a pool of resources to become virtual devices. The delegations might be static or dynamic, depending on the manufacturer's implementation. The type of virtual machines being generated depends on the manufacturer's implementation.

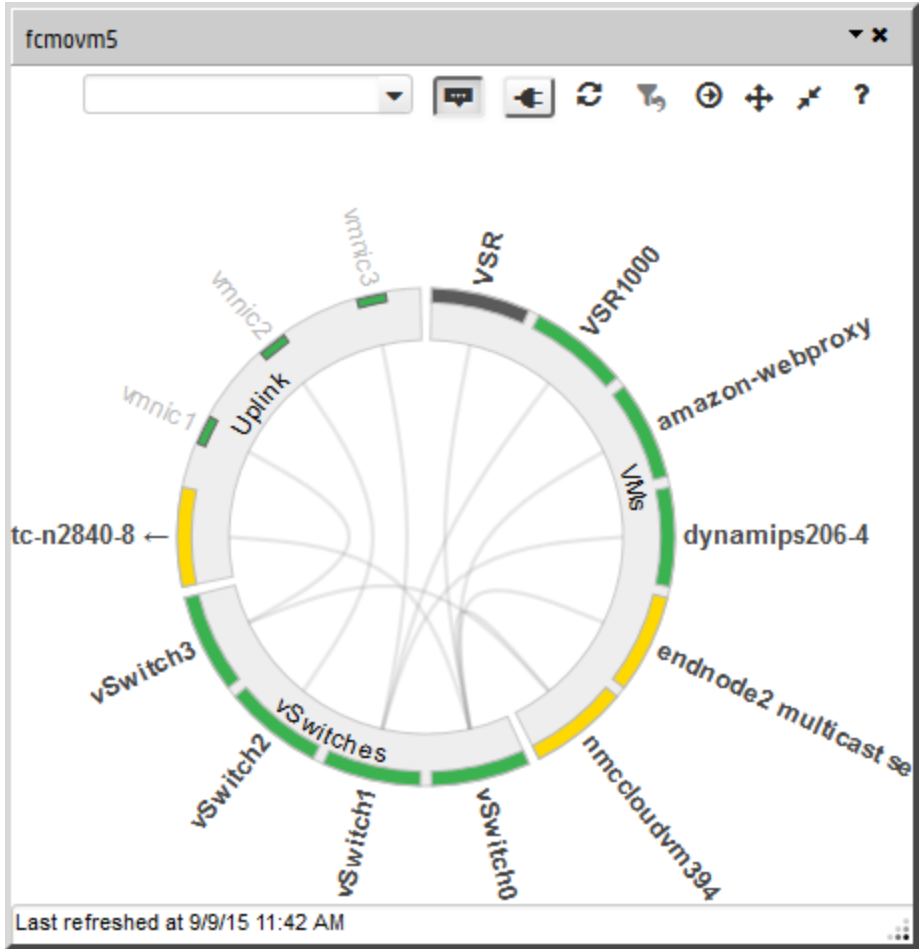

Slide 2: Inner ring segments represent *categories* of device types being provided by the hypervisor:

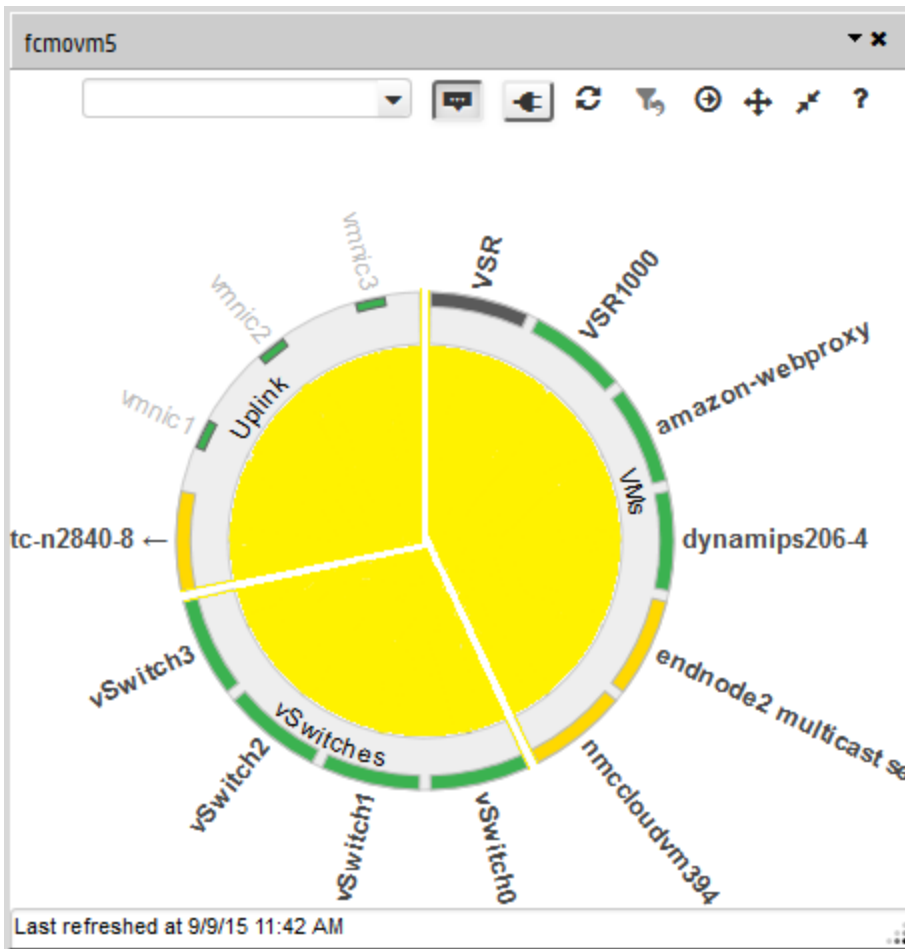

Slide 3: Outer ring segments represent virtual devices being deployed by the hypervisor:

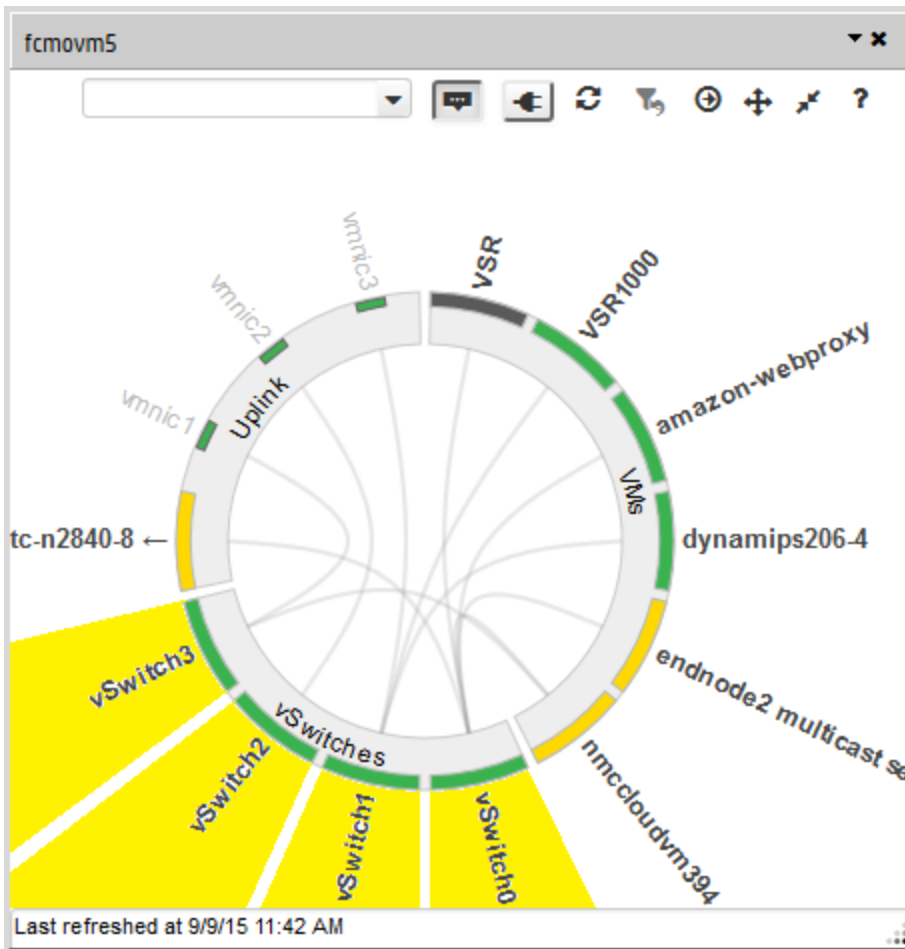

Slide 4: Hover a name to display that object's current communication channels:

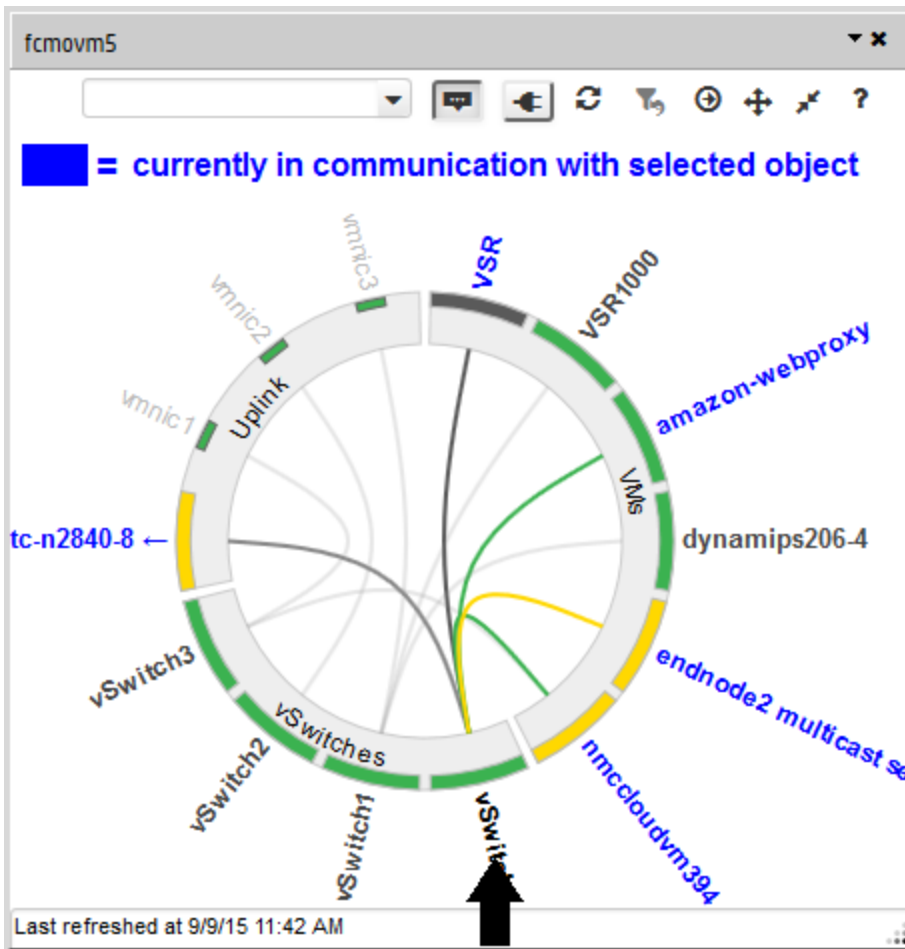

Slide 7: Highlight the device name to display connection details:

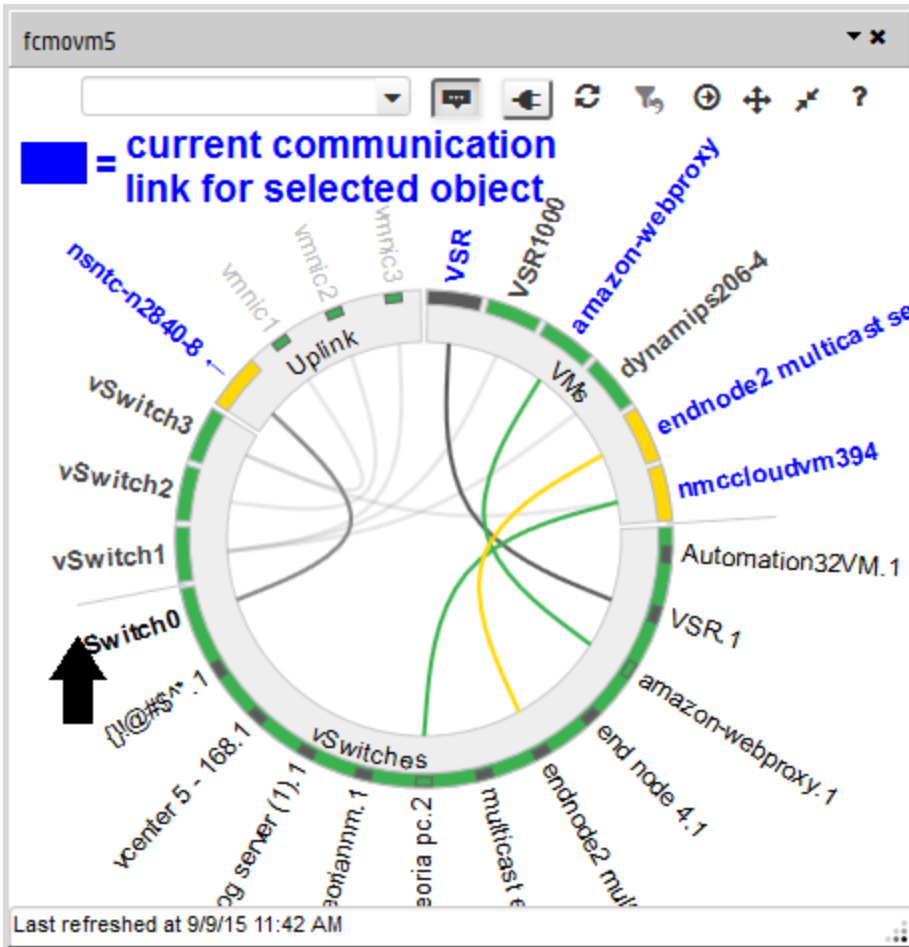

Slide 8: Click an inner arc to hide or show all device interfaces or ports within a category of devices:

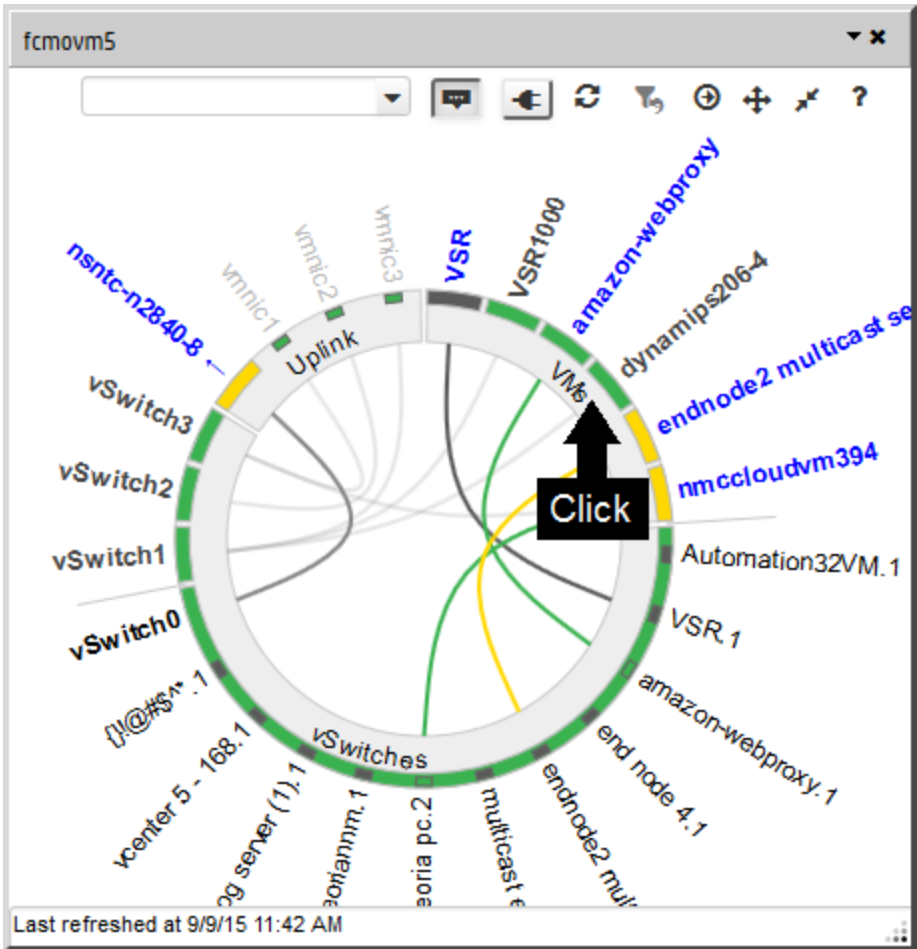

Slide 9: Color represents current status for each node, interface, or port:

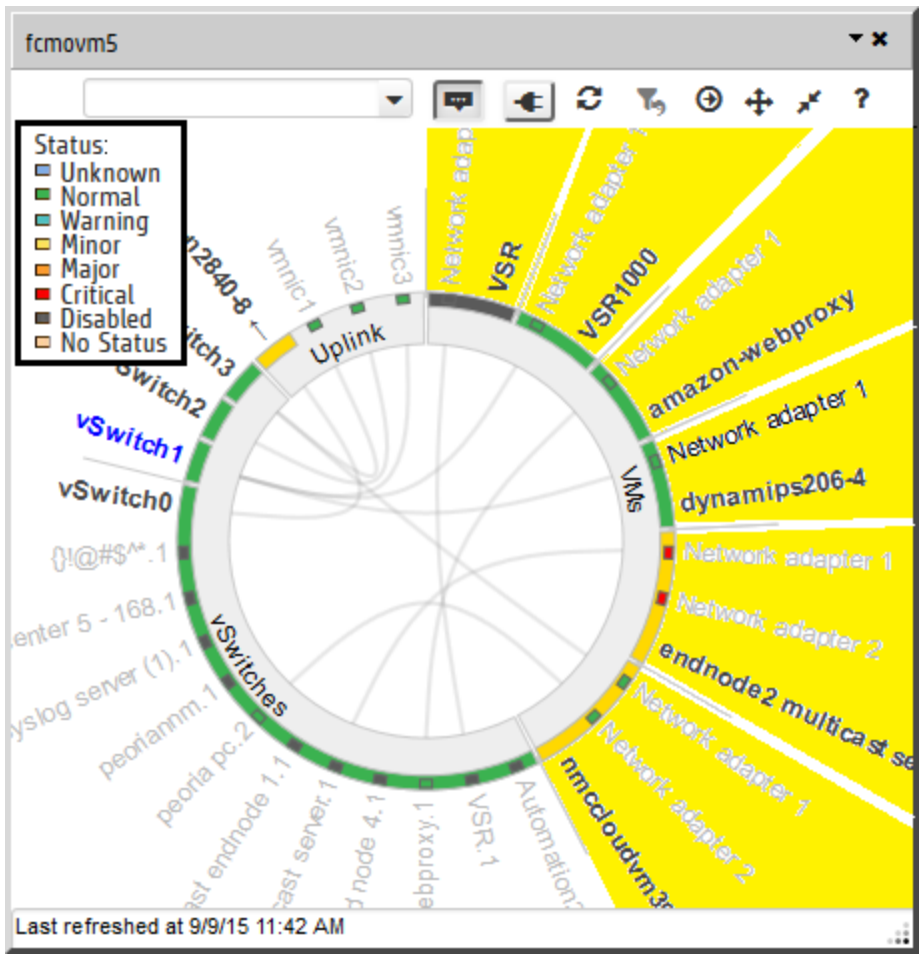

Slide 10-11:  Powered Off resources can be shown or hidden:

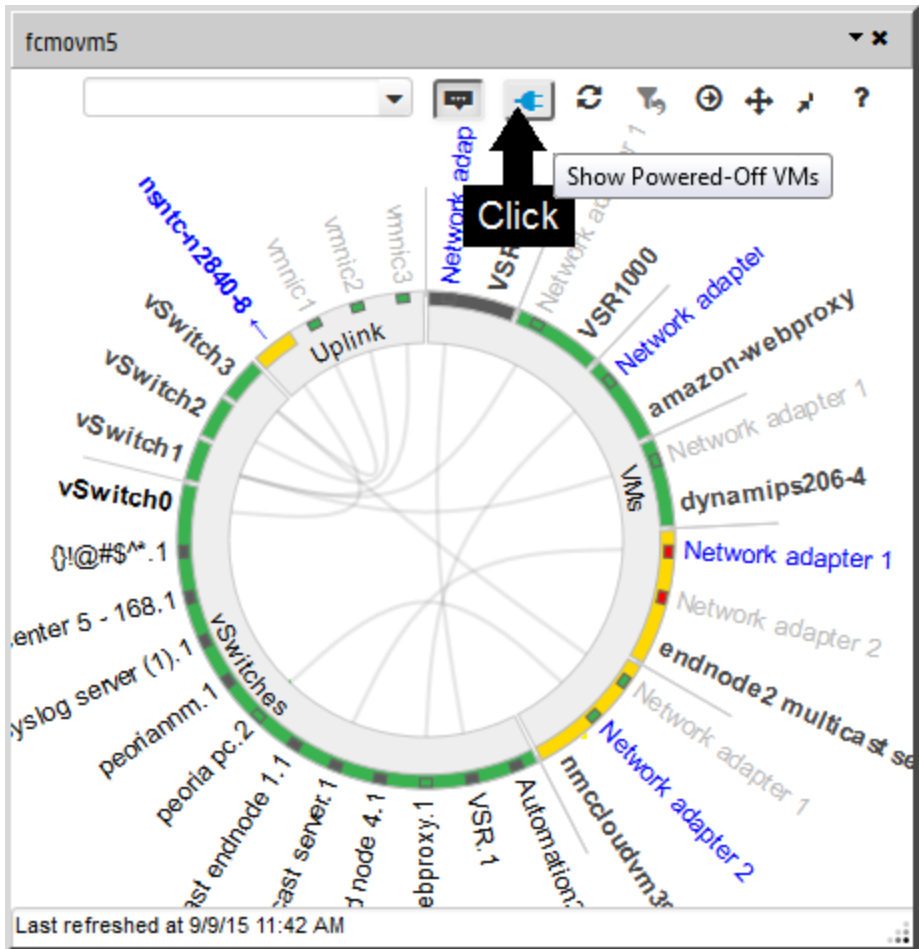

Slide 12-13: Search for and find any node, interface, or port:



Slide 14-15: Filter the Wheel to one device's environment:

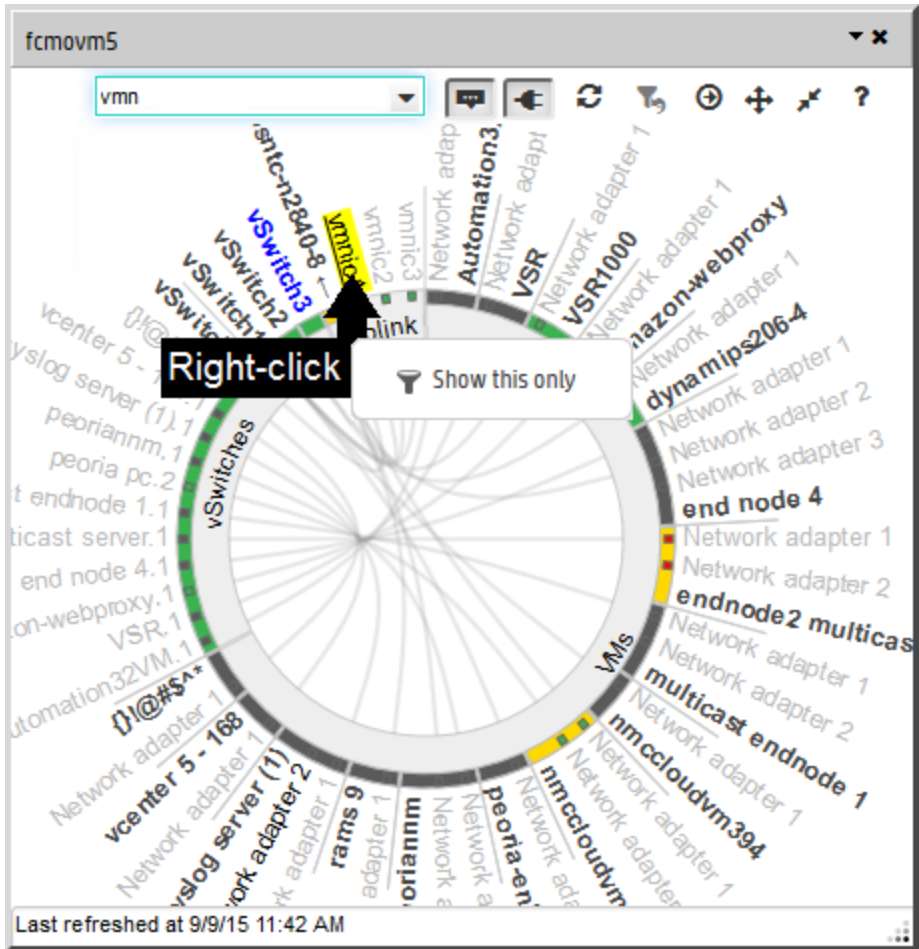

Return to the previous display:

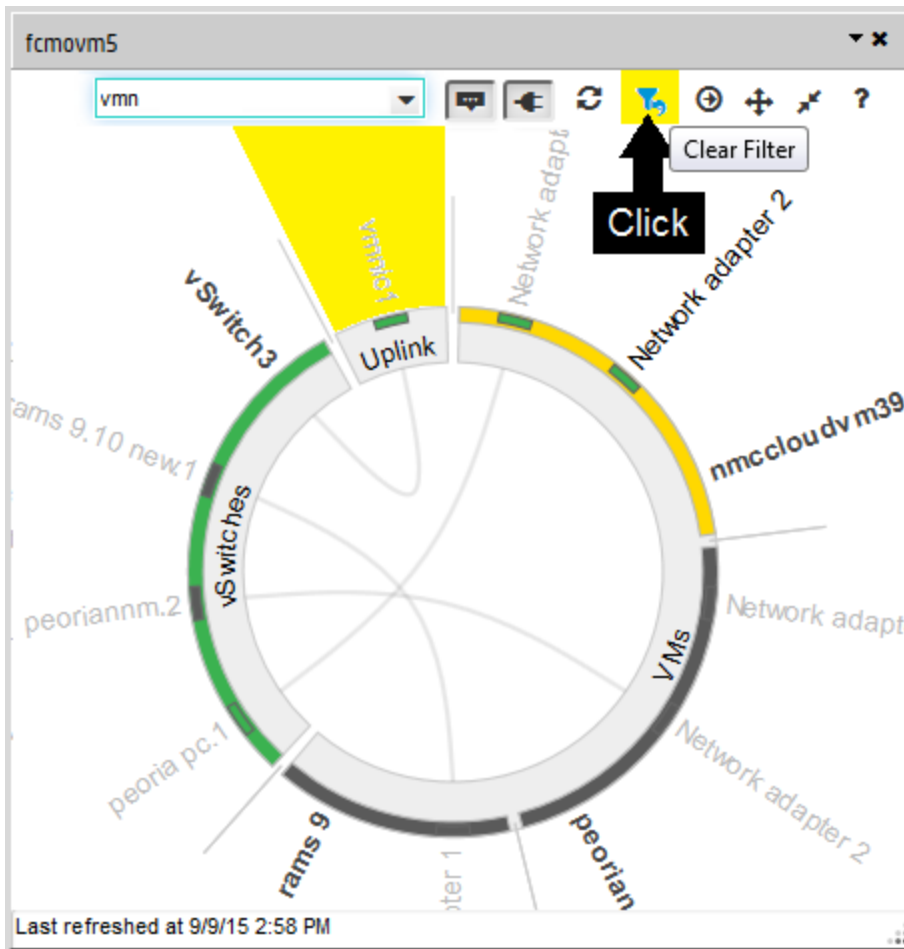

Change Size and Location of the Wheel

Left-click the background to establish which point should be considered the new center, and use the mouse to:

- Rotate the mouse wheel to zoom in or zoom out.
- Drag to pan to a new location a short distance within the diagram.
- Pan while maintaining the current highlighted selection (for example follow a highlighted connection line across the diagram):
 - Ctrl + rotate the mouse wheel
 - Ctrl-drag

You can also change the size and location of the popup. NNMi remembers your preferences from session to session (per browser):

Note: When minimized the Wheel appears at the bottom of the console window with the hypervisor's name:

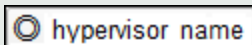

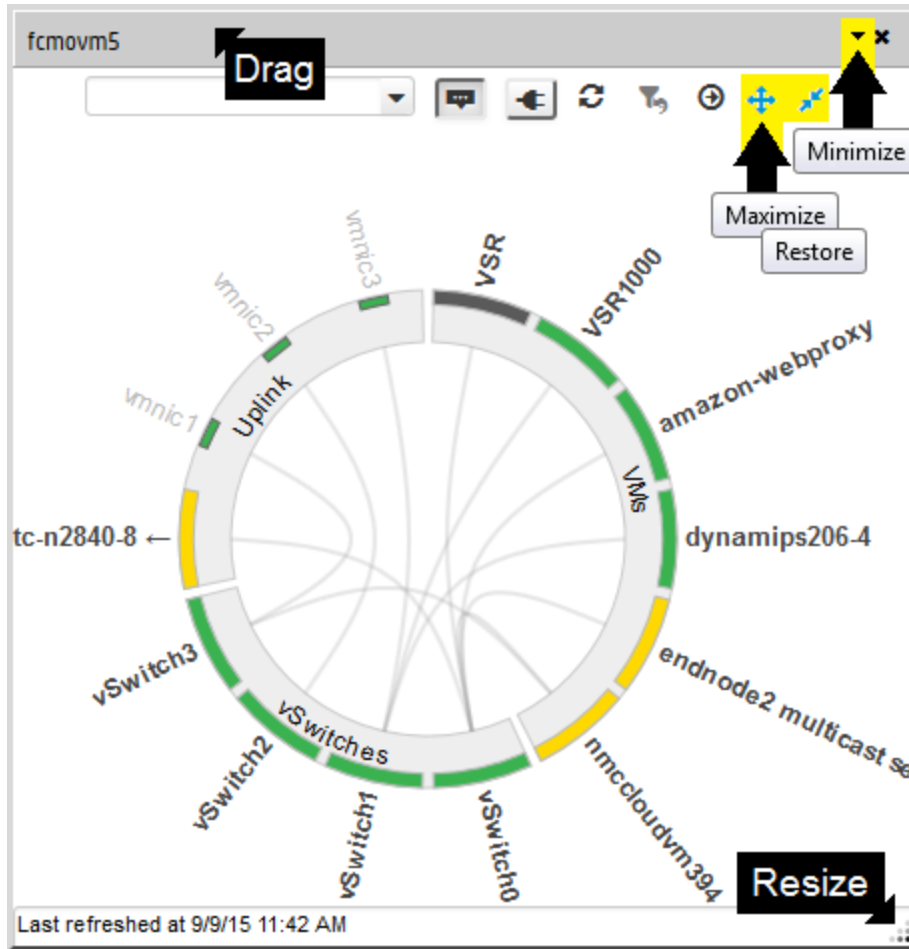

Display Additional Information

- Click any text around the outside perimeter of the Wheel to populate the Analysis Pane in the main console.
- Double-click any text around the outside perimeter of the Wheel to display the node or interface form in the main console.

Note: When the Wheel Dialog is launched from a map view, clicking an object on the wheel automatically highlights that object on the map. See also ["Using Hypervisor Diagrams and Dialogs" on page 116](#).

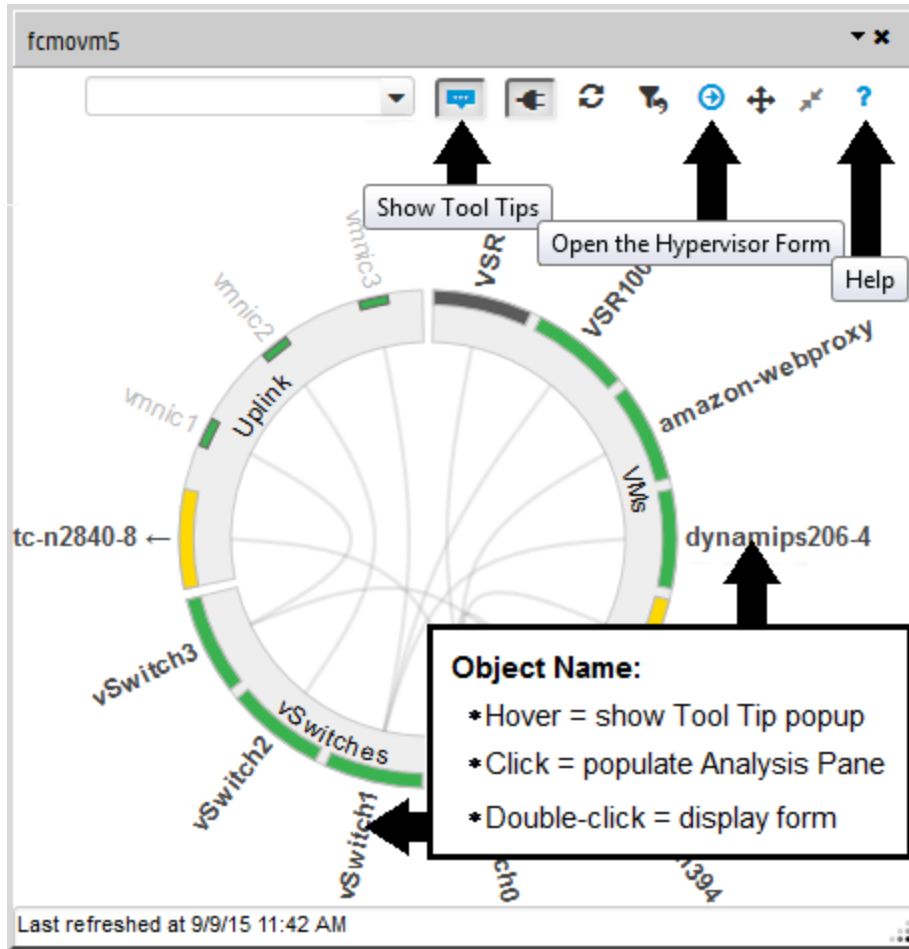

Display devices connected beyond the Wheel

1. In the Wheel Dialog toolbar, click **Open the Hypervisor Form** to display the Node form in the main console.
2. Use **Actions** → **Maps** → **Layer 2 Neighbor View**.

Tip: In addition to the following, you will see everything else connected to the access Switch.

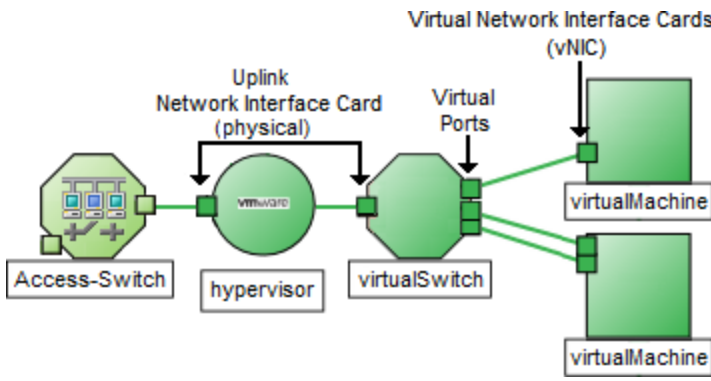















3. In the map toolbar, increase the **Number of Hops** setting to see a wider range of connections.

Toolbar Actions

Toolbar icons are at the top of the Wheel Dialog:



Icon	Description
	<p>Dock. Minimizes the Wheel Dialog into a small rectangular link at the bottom right side of the console's workspace:</p>
	<p>Close. Close the Wheel Dialog.</p>
	<p>Find Auto complete pull-down that allows you to pick an item by VM name, VSwitch name, interface name, management address, or IP address:</p> <p>To highlight the selected object in the diagram, do one of the following:</p> <ul style="list-style-type: none"> • Click a list item • Press enter <p>Note: If the selected item is not currently visible, NNMi automatically takes the appropriate action:</p> <ul style="list-style-type: none"> • The parent object is expanded to display the selected item. • All powered off items are shown to display the selected item.
 or 	<p>Show Tool Tips. Toggle button to Enable or Disable popups showing additional information when you mouse-over an object:</p> <ul style="list-style-type: none"> • Virtual Machines popup shows Name, Management Address, Power State, and System Description • Virtual Switches and Virtual Interfaces popup shows ifName, ifAlias, ifTtype, and all current IP addresses
 or 	<p>Powered-Off VMs. Toggle button to Show or Hide all VMs currently with a Power State of Powered Off. See Nodes (All Attributes) view.</p>
	<p>Refresh. Refreshes the current diagram, showing the most recent virtual configuration and status of each object.</p>
or	<p>The icon is grey when the current Wheel depicts a hypervisor and all virtual objects being provided by that hypervisor.</p>

Icon	Description
	<p> The icon is black when the current loom depicts a subset of a hypervisor's resources (Virtual Switch, Virtual Interface, or physical interface).</p> <div style="border: 1px solid #ccc; padding: 5px; margin-top: 10px;">  Show this only </div> <p>Simplifies the Wheel diagram by hiding anything not directly in communication with the selected object.</p>
	<p>Open the Hypervisor Form. Displays the hypervisor's form no matter which subset of the hypervisor's resources are currently displayed in the Wheel.</p> <div style="background-color: #f0f0f0; padding: 5px; margin-top: 10px;"> <p>Tip: Double-click any node or interface label to display that object's form.</p> </div>
 or 	<p>Maximize.</p> <p> The icon is black when clicking will make the Wheel Dialog is as large as possible, filling all space currently available within the NNMi console window.</p> <p> The icon is gray when the loom is already maximized. See  Restore (below).</p>
	<p>Restore. Reverts the dialog to the size and settings prior to clicking  Maximize.</p>
	<p>Help. Click the icon for access to the Wheel Dialog Help.</p>
	<p>Resize:</p> <ol style="list-style-type: none"> 1. Click the Wheel Dialog's title bar and move it to the desired location within the console. 2. Drag the bottom right corner  to resize the dialog to the preferred size. <div style="background-color: #f0f0f0; padding: 5px; margin-top: 10px;"> <p>Note: NNMi remembers your preference for size and location (stored in your browser settings).</p> </div>

Using the Loom Dialog

Change What Is Displayed within the Loom

(NNMi Advanced) The Loom Dialog shows the current deployment of virtual resources:

Slide 1: The initial display shows the entire set of virtual nodes currently being deployed by the **hypervisor**¹ (any resources that are currently Powered Off are not displayed):

¹The virtual machine manager in charge of delegating various aspects from a pool of resources to become virtual devices. The delegations might be static or dynamic, depending on the manufacturer's implementation. The type of virtual machines being generated depends on the manufacturer's implementation.

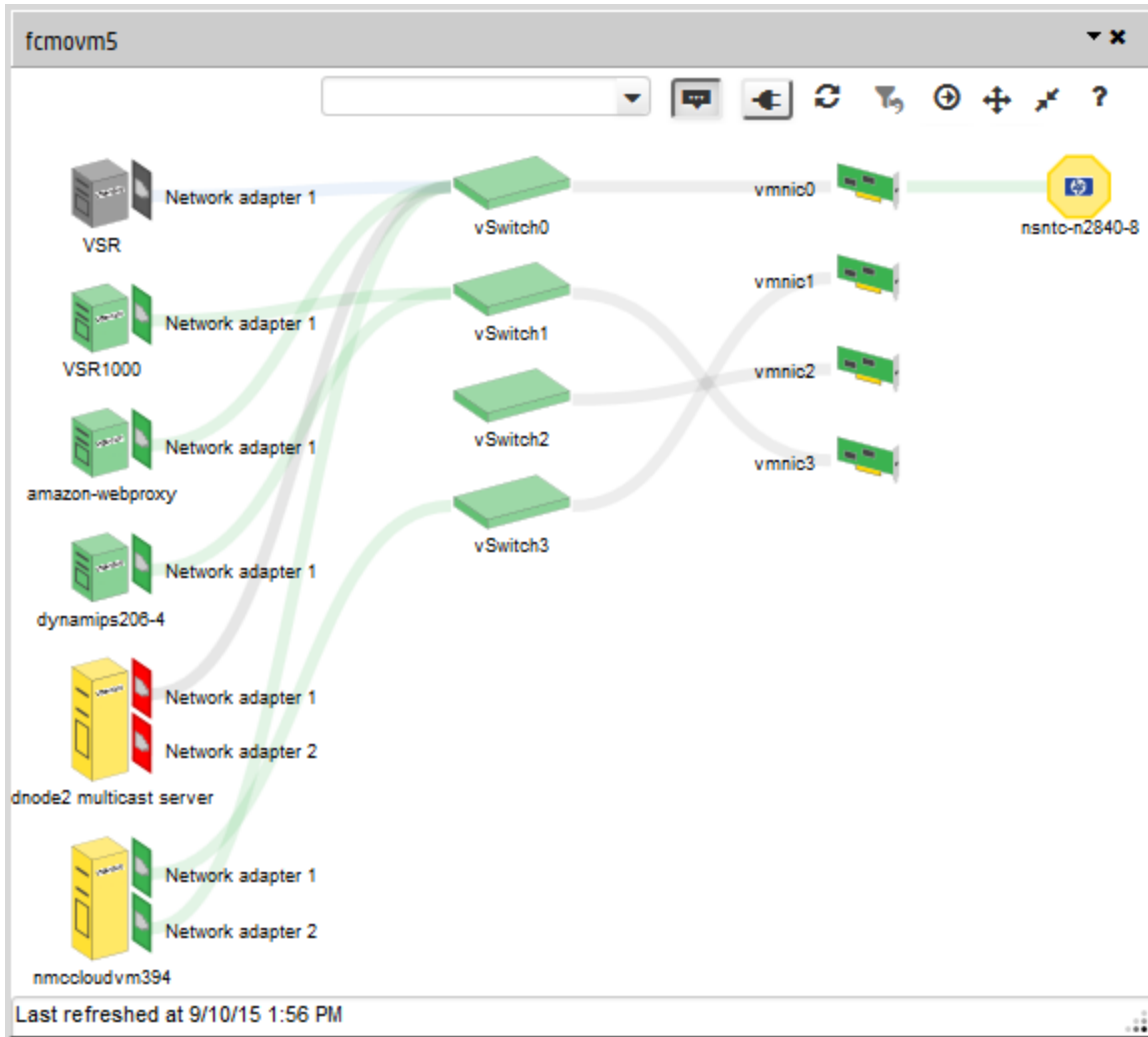

Slide 2: Columns represent *categories* of device types being provided by the hypervisor:

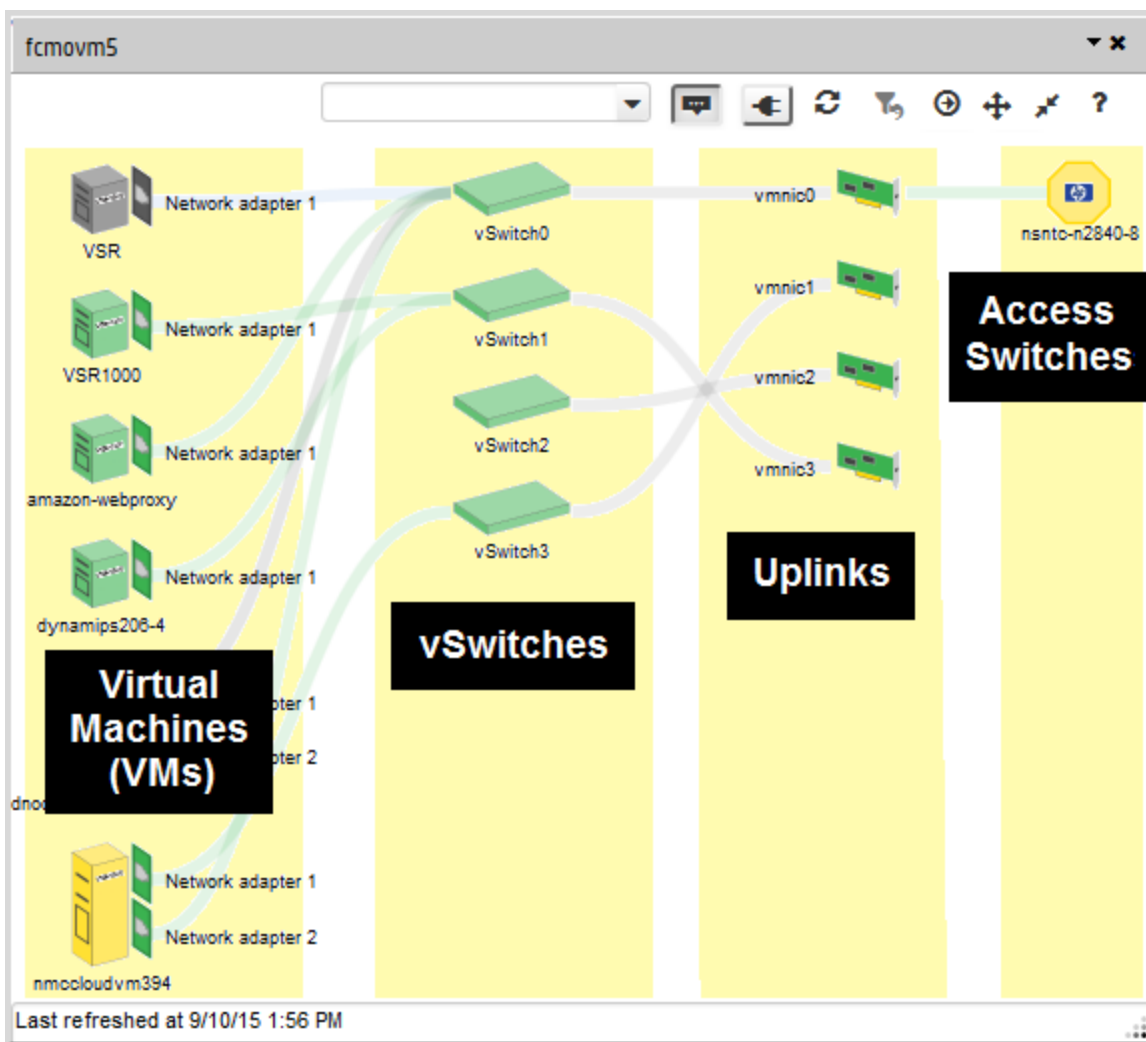

Slide 3: Hover a name to display the connections assigned to that object:

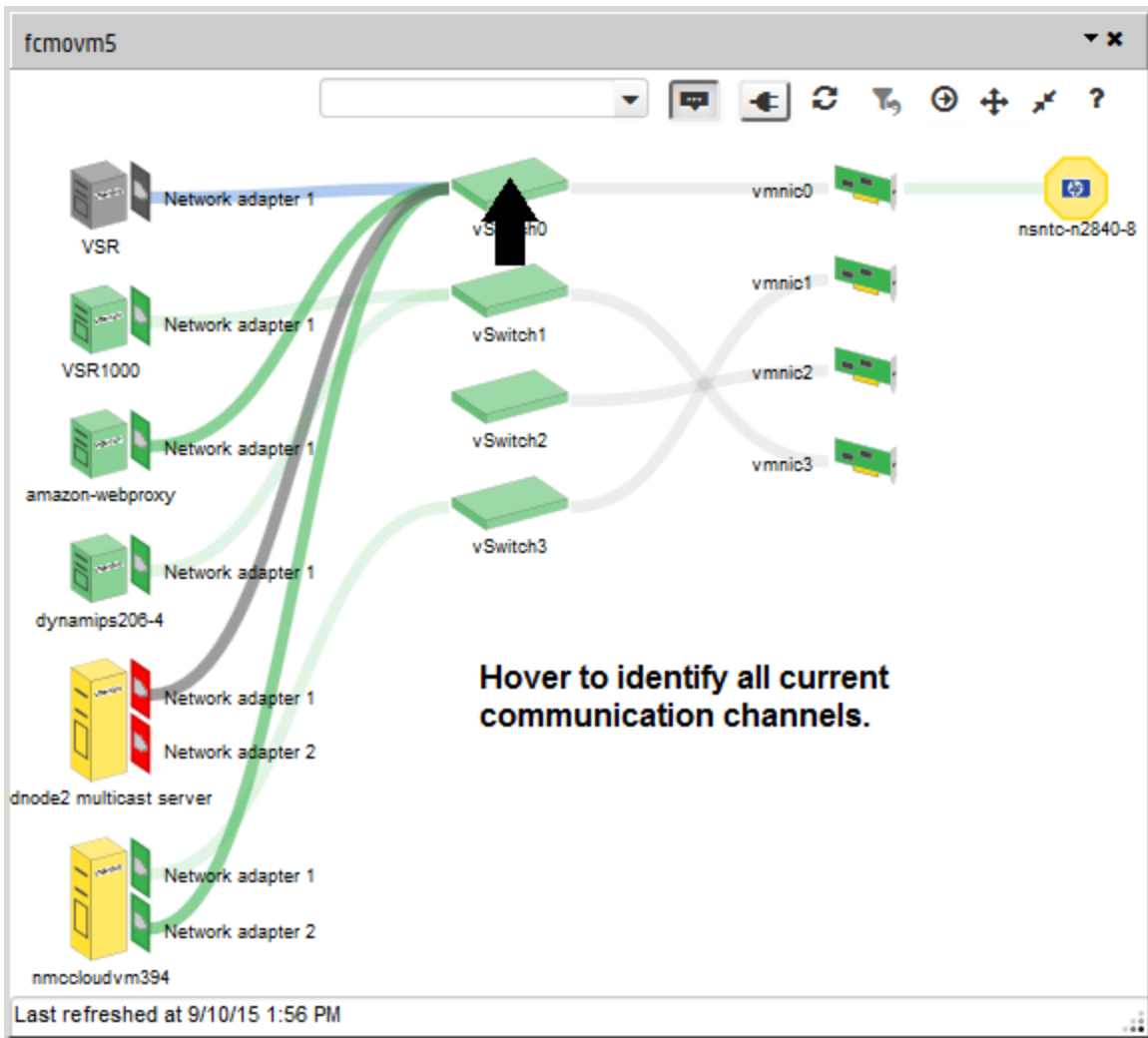

Slide 4-5: Right-click to show or hide one device's interfaces or ports:

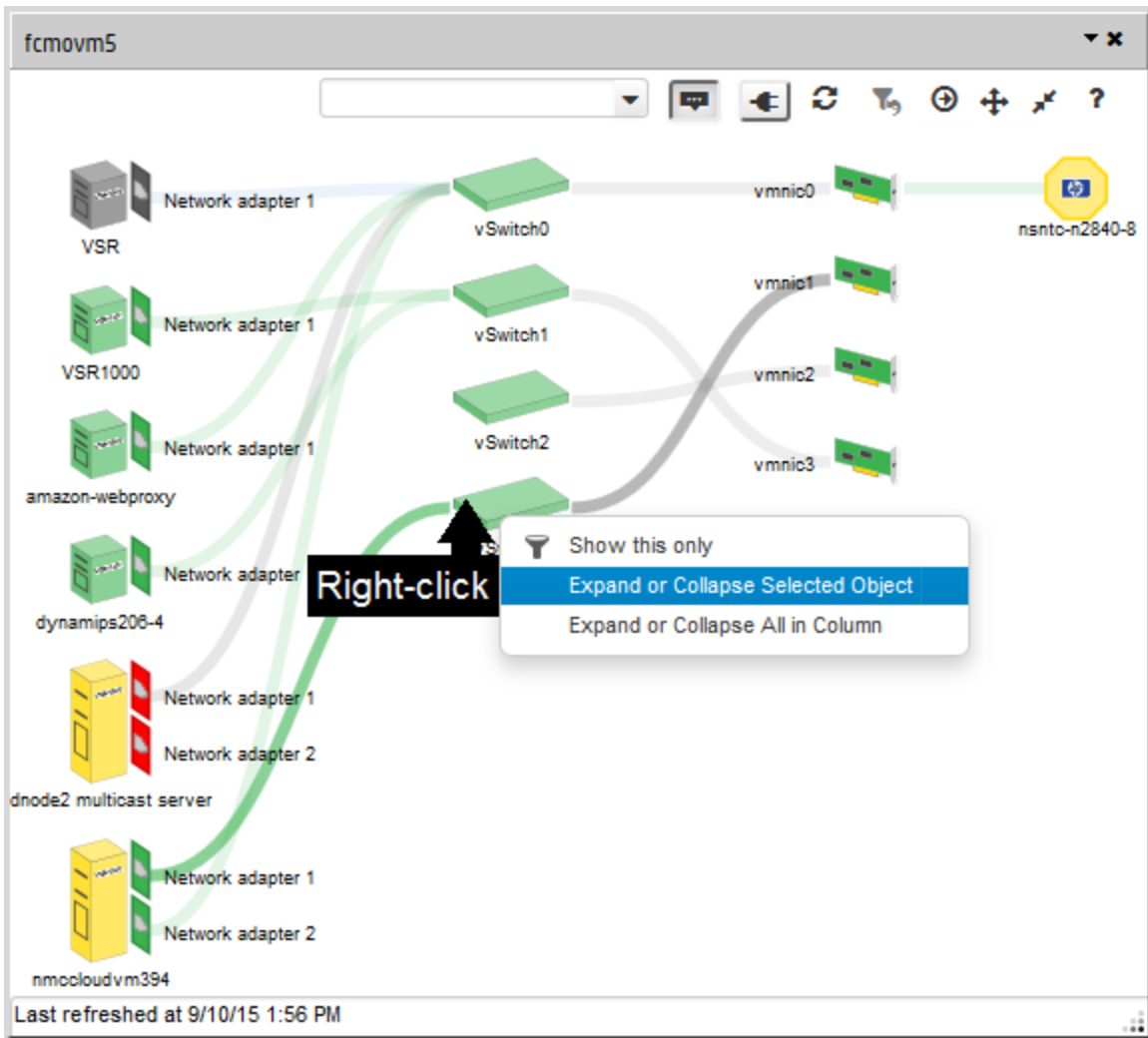

The interfaces or ports are represented within the object.

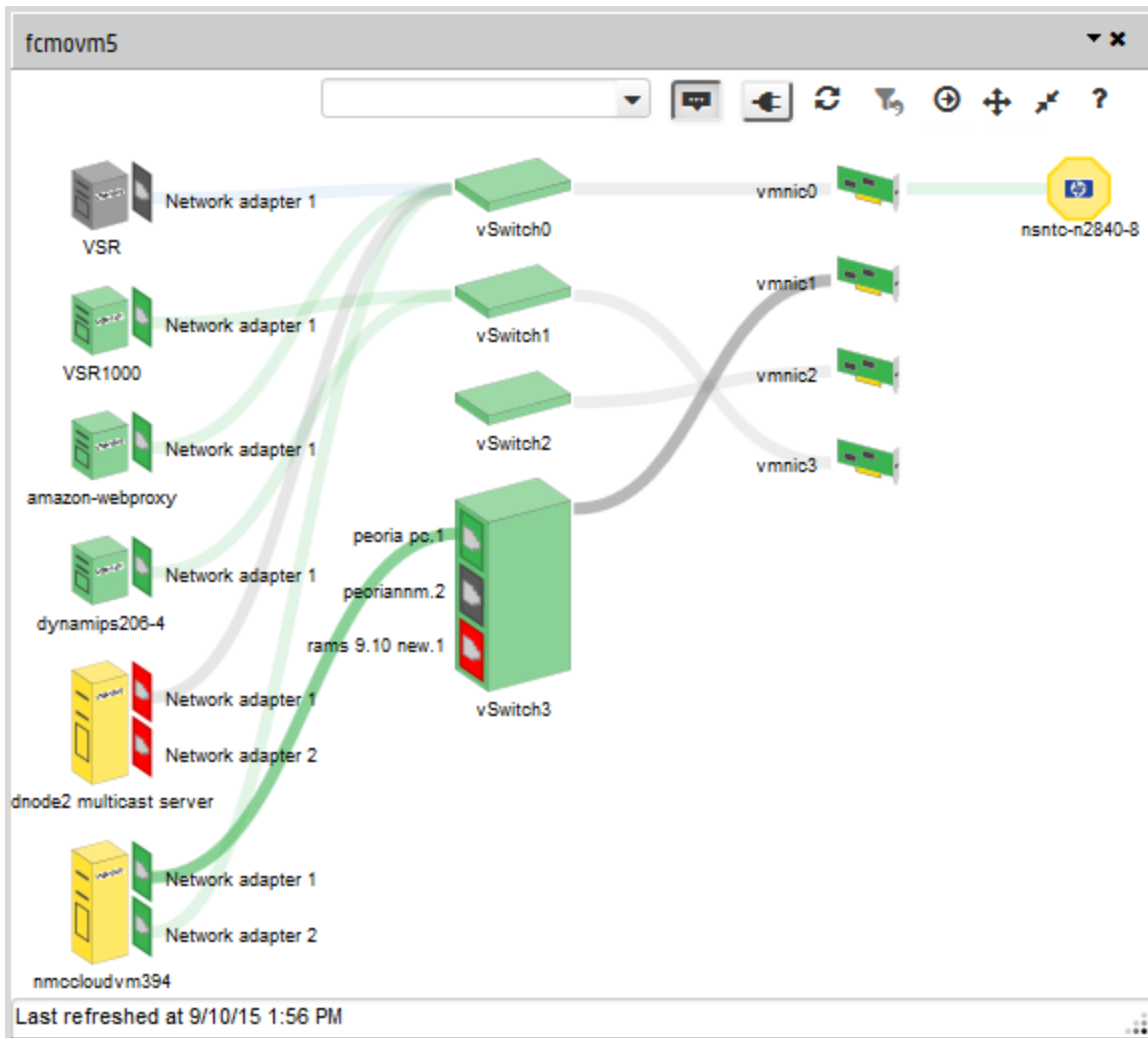

Slide 6: Right-click to show all device interfaces or ports within a category of devices:

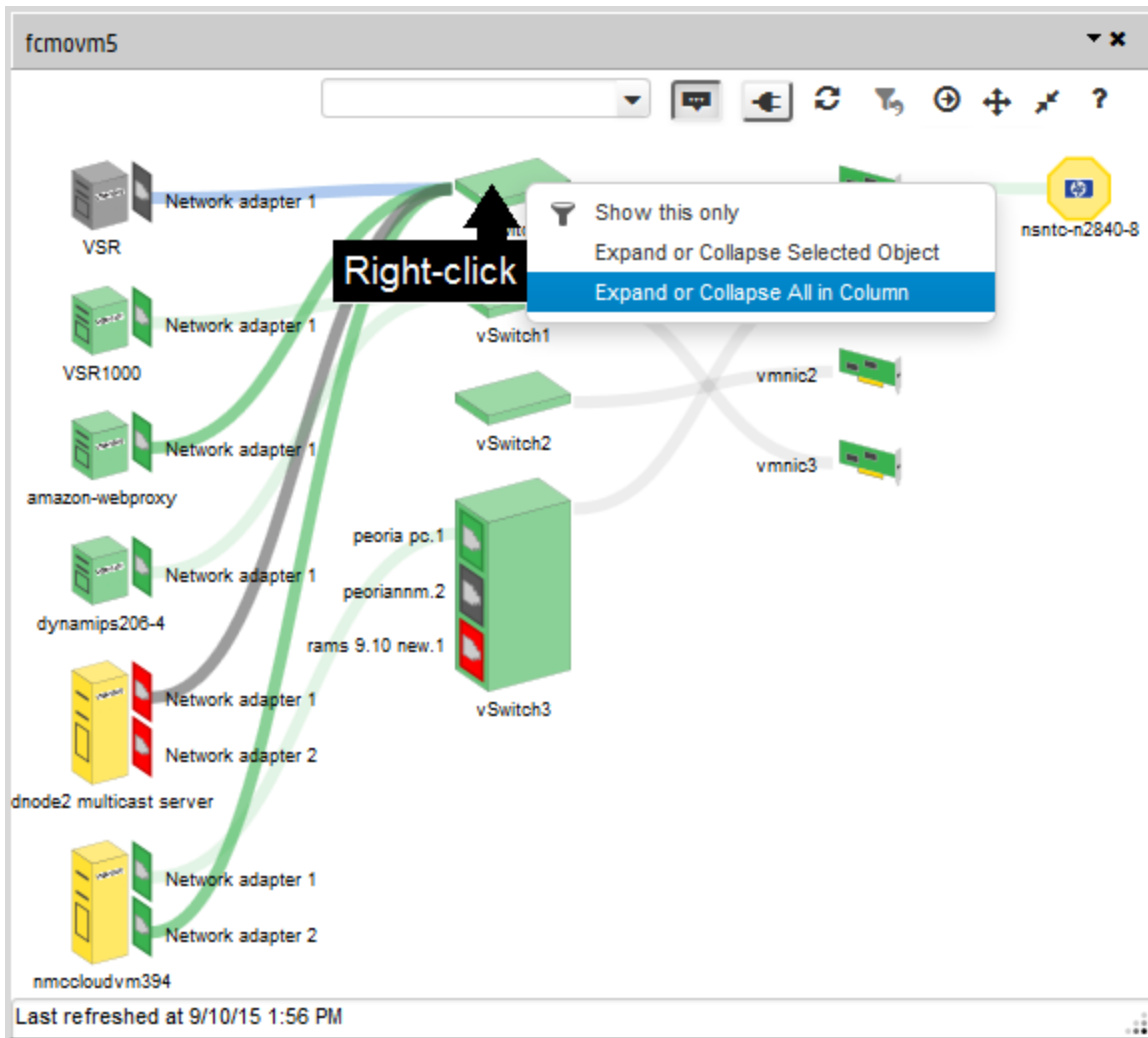

Slide 7: Color represents current status for each node, interface, or port:

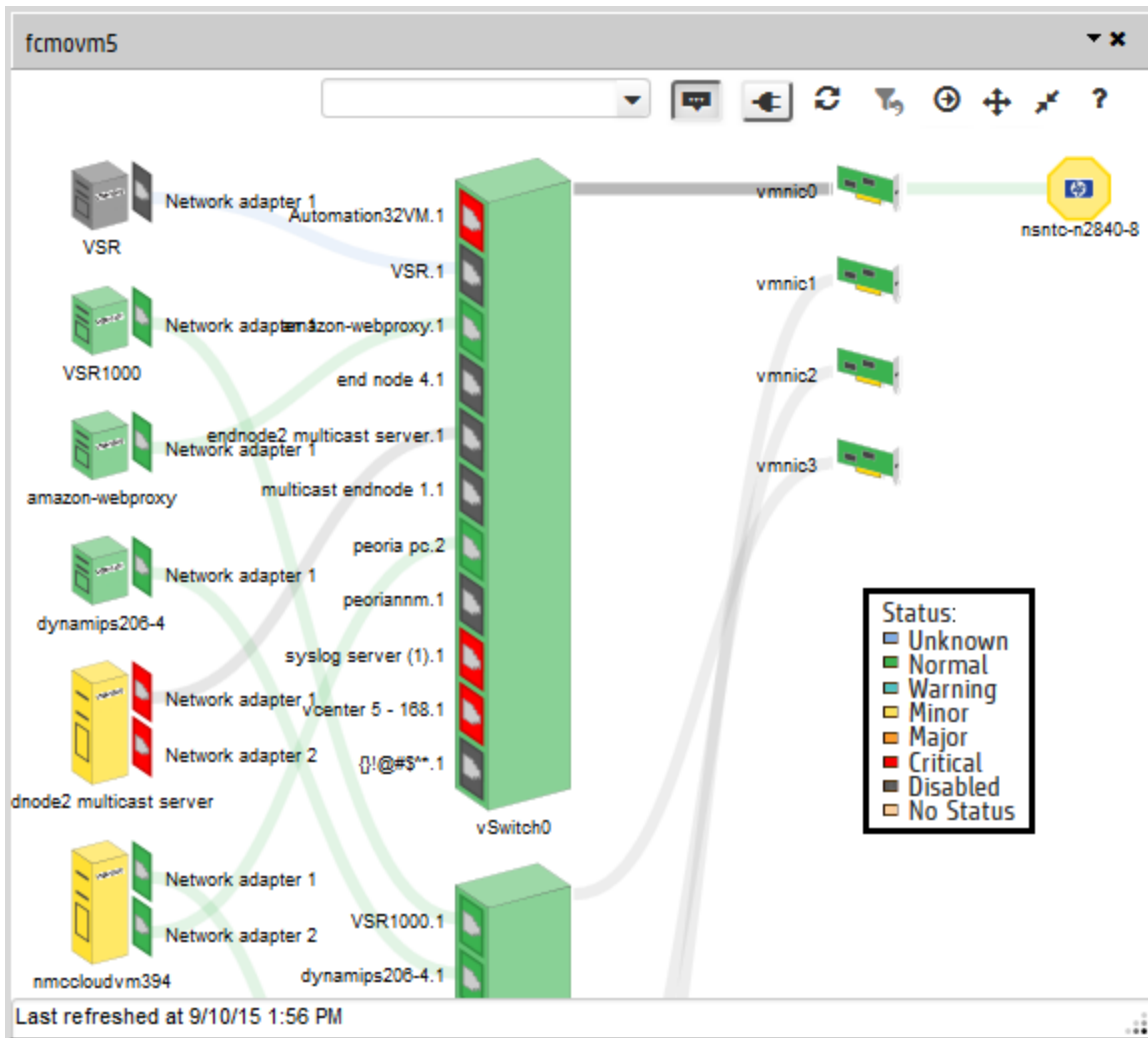

Slide 8: Right-click to hide all device interfaces or ports within a category of devices:

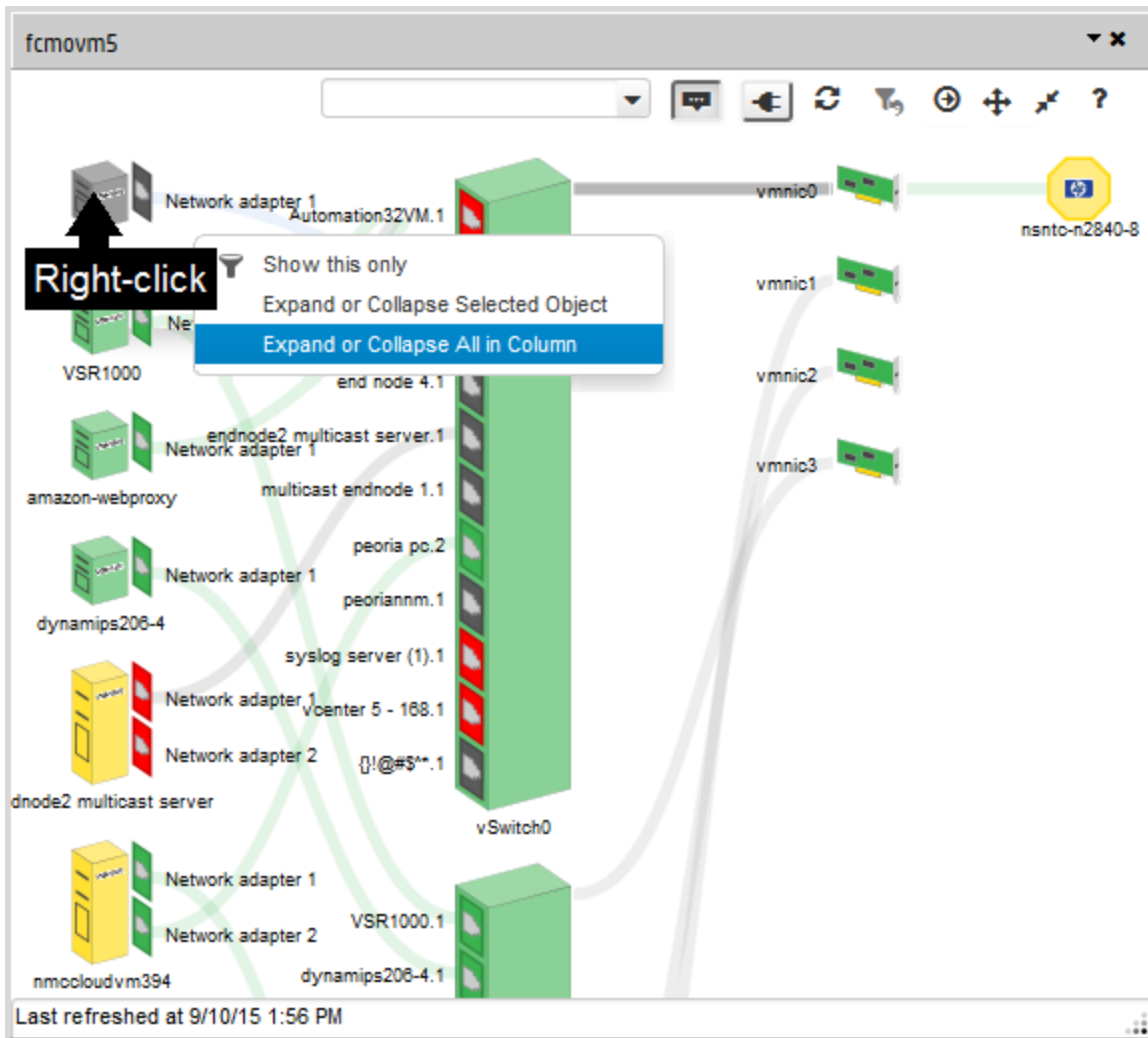

Slide 9-10:  Powered Off resources can be shown or hidden:

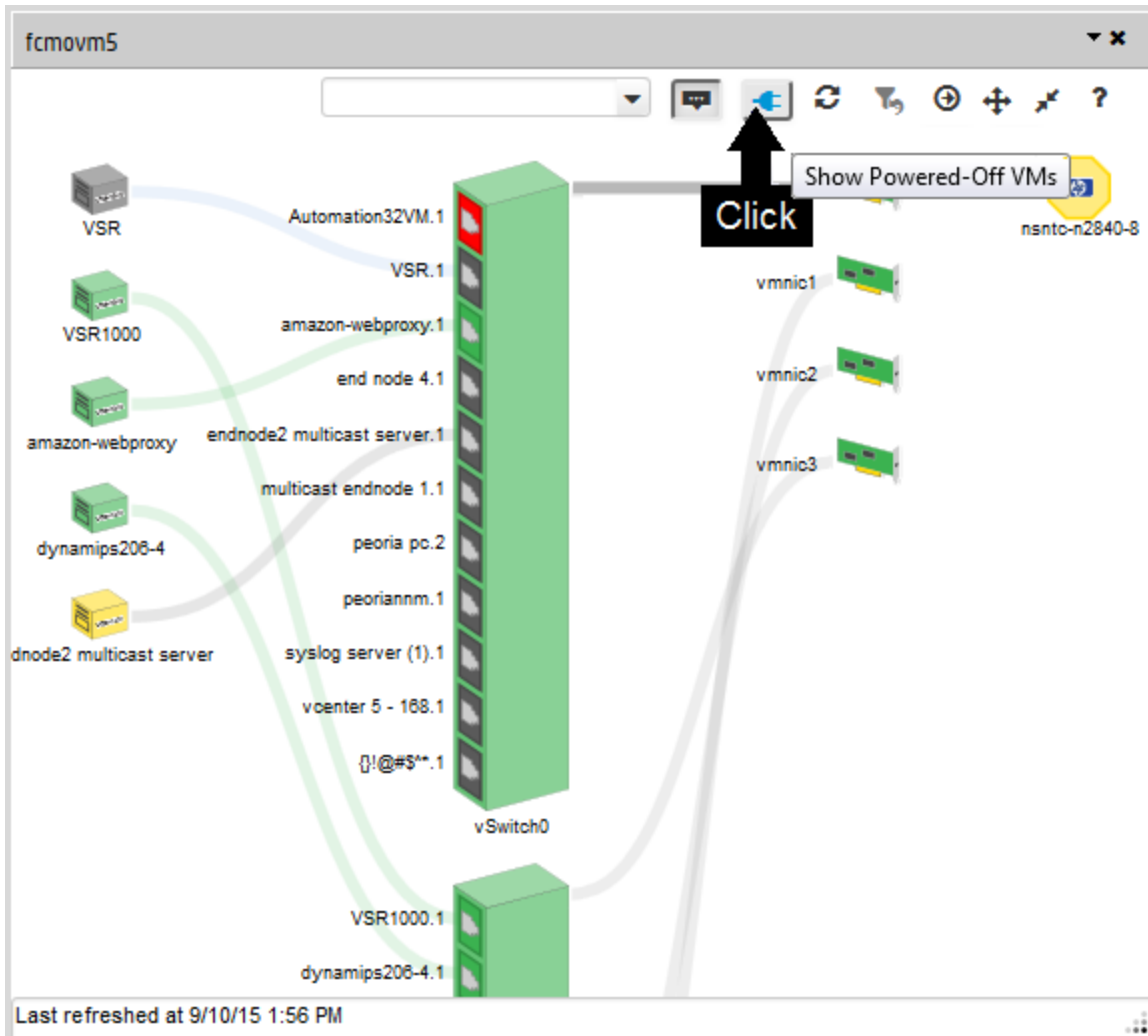

Their status color is gray:

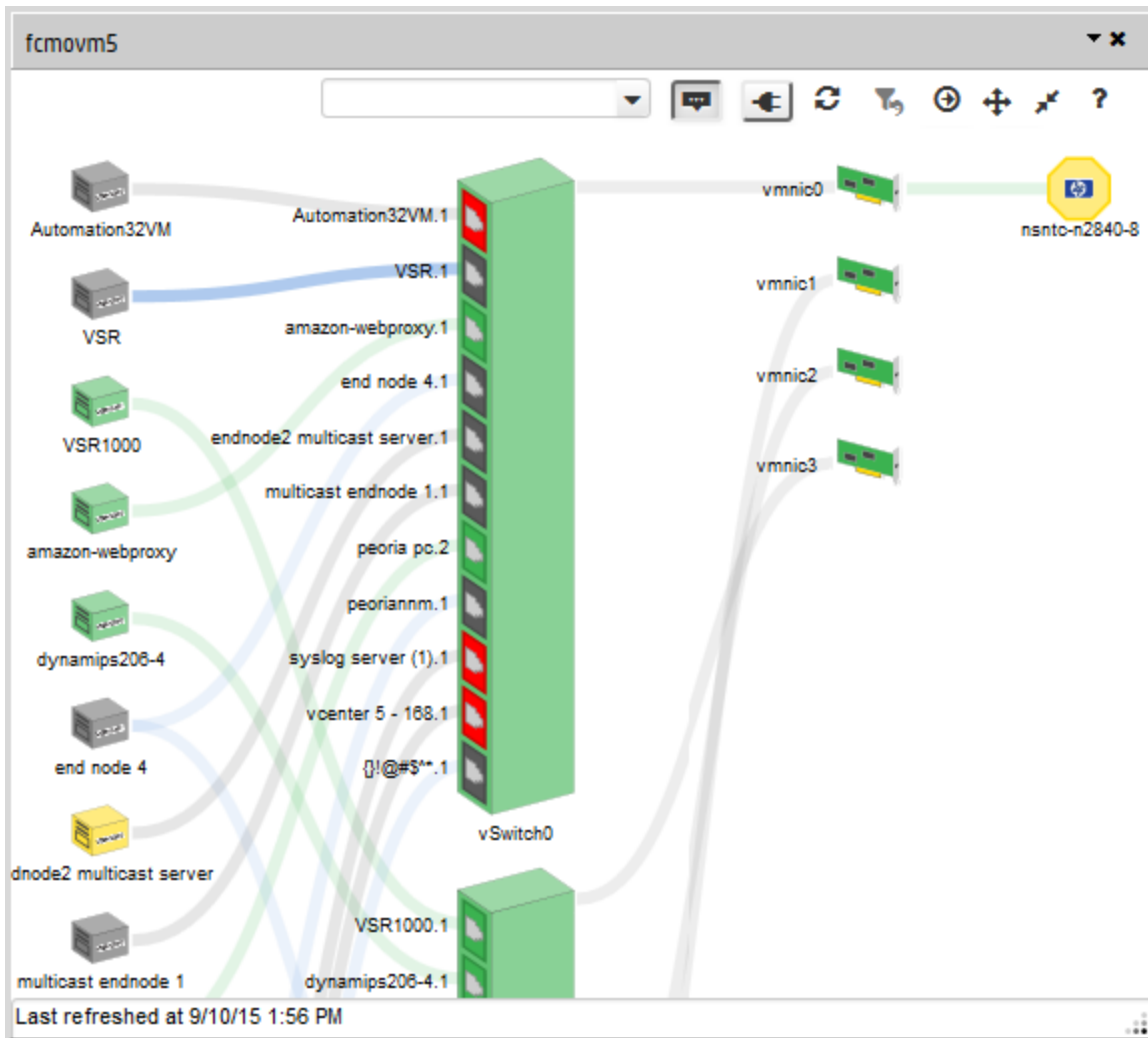

Slide 11-12: Search for and find any node, interface, or port:

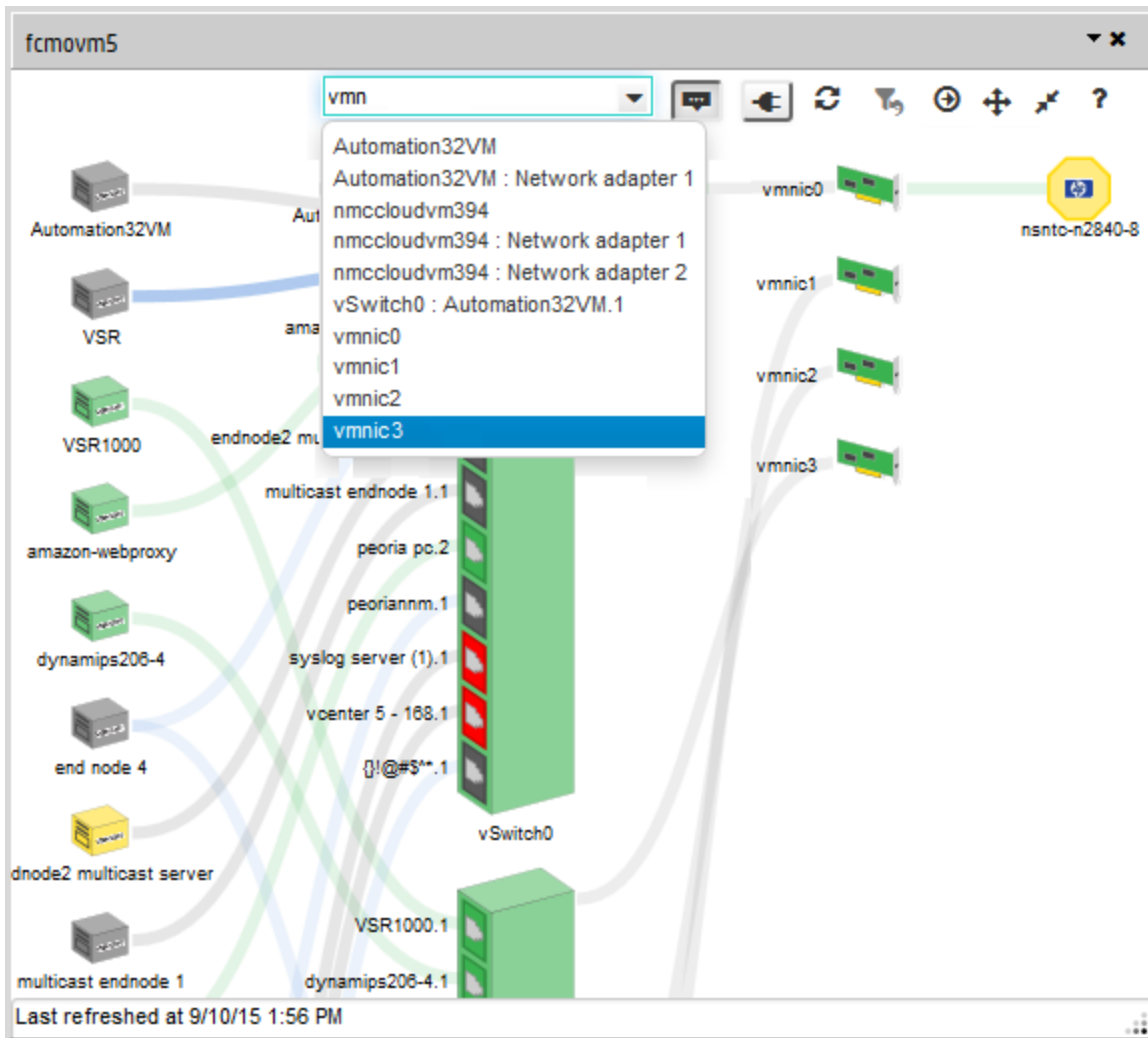

The found object is displayed and highlighted:

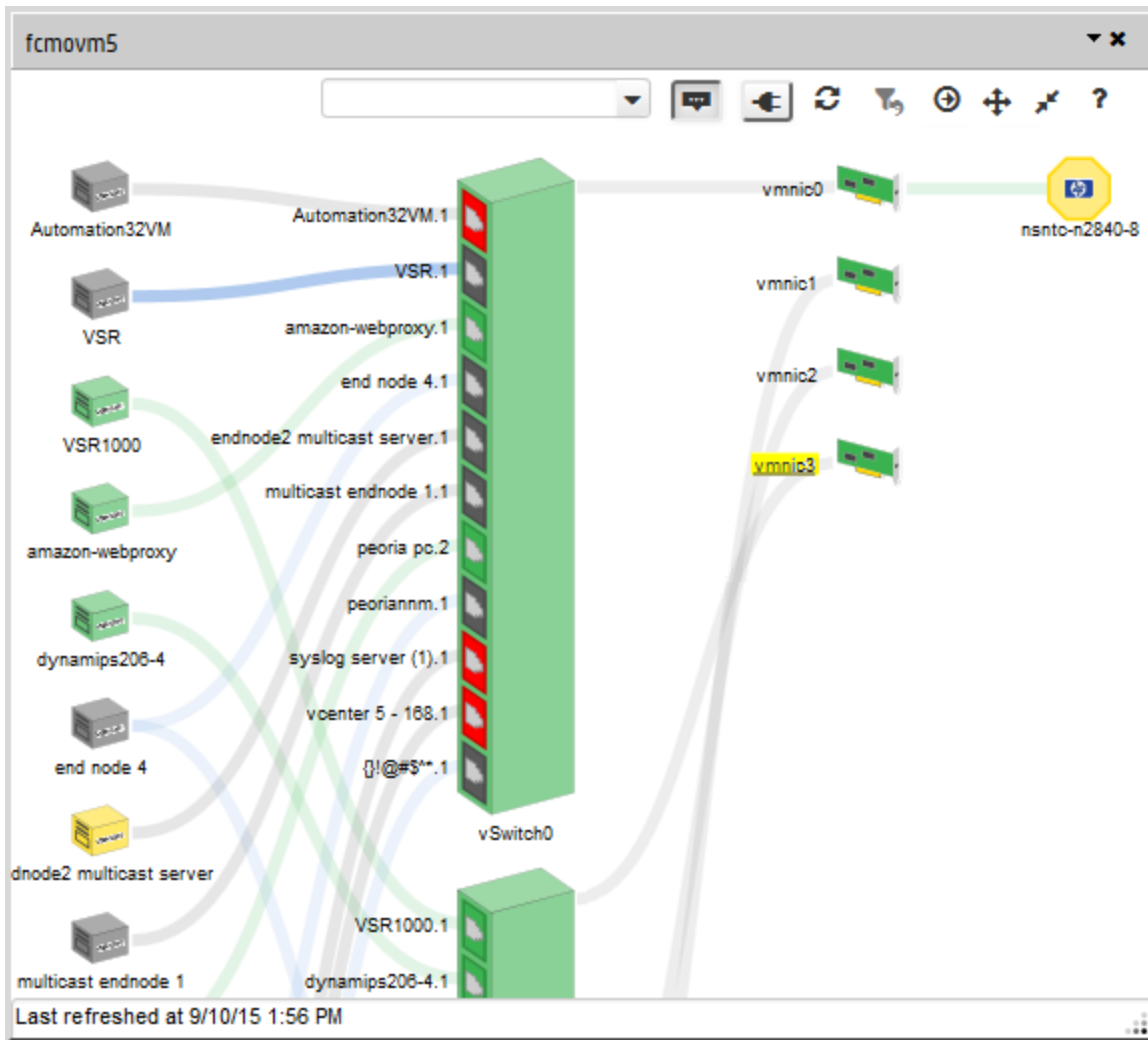

Slide 13-14: Filter the Loom to one device's environment:

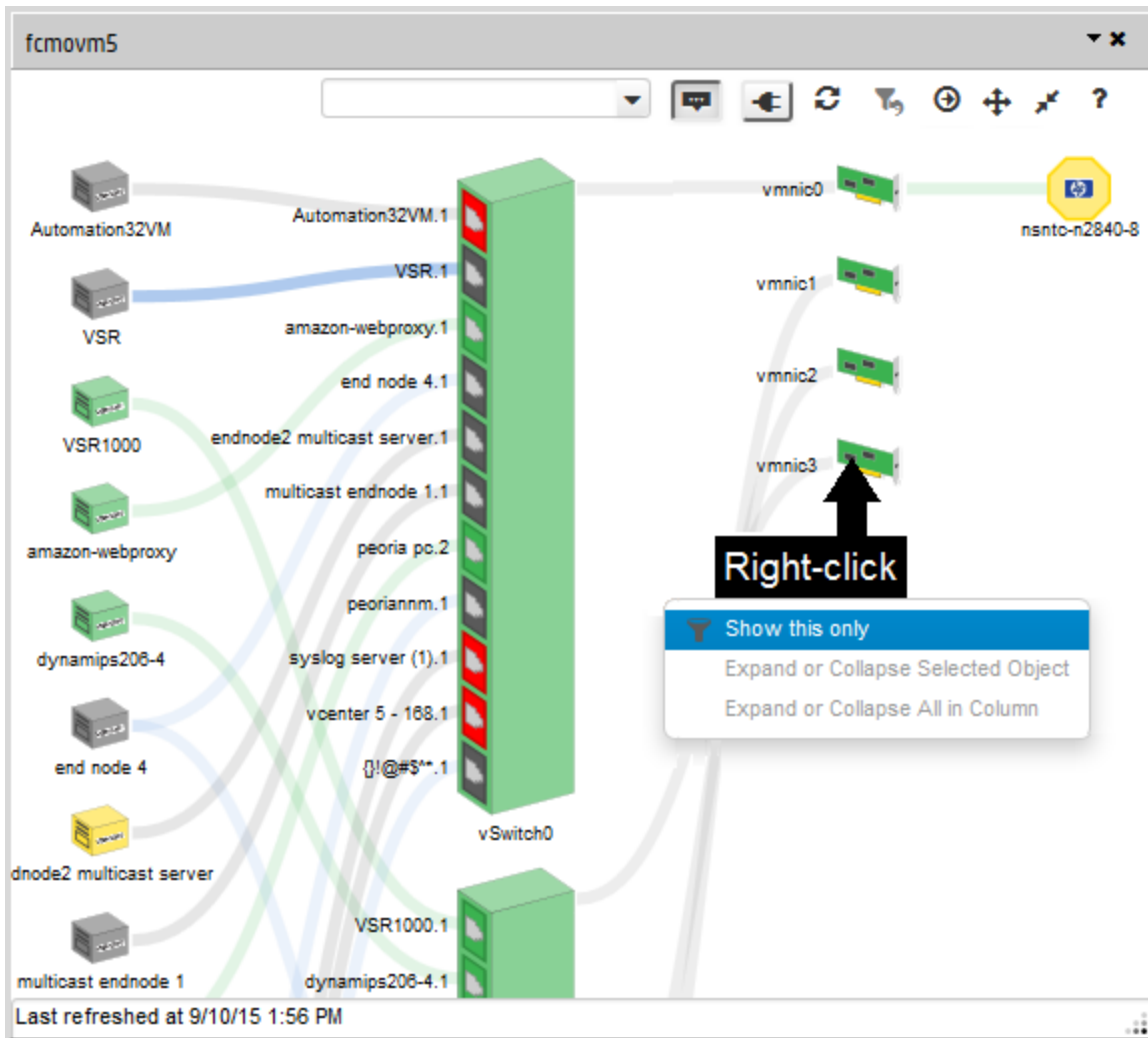

Return to the previous display:

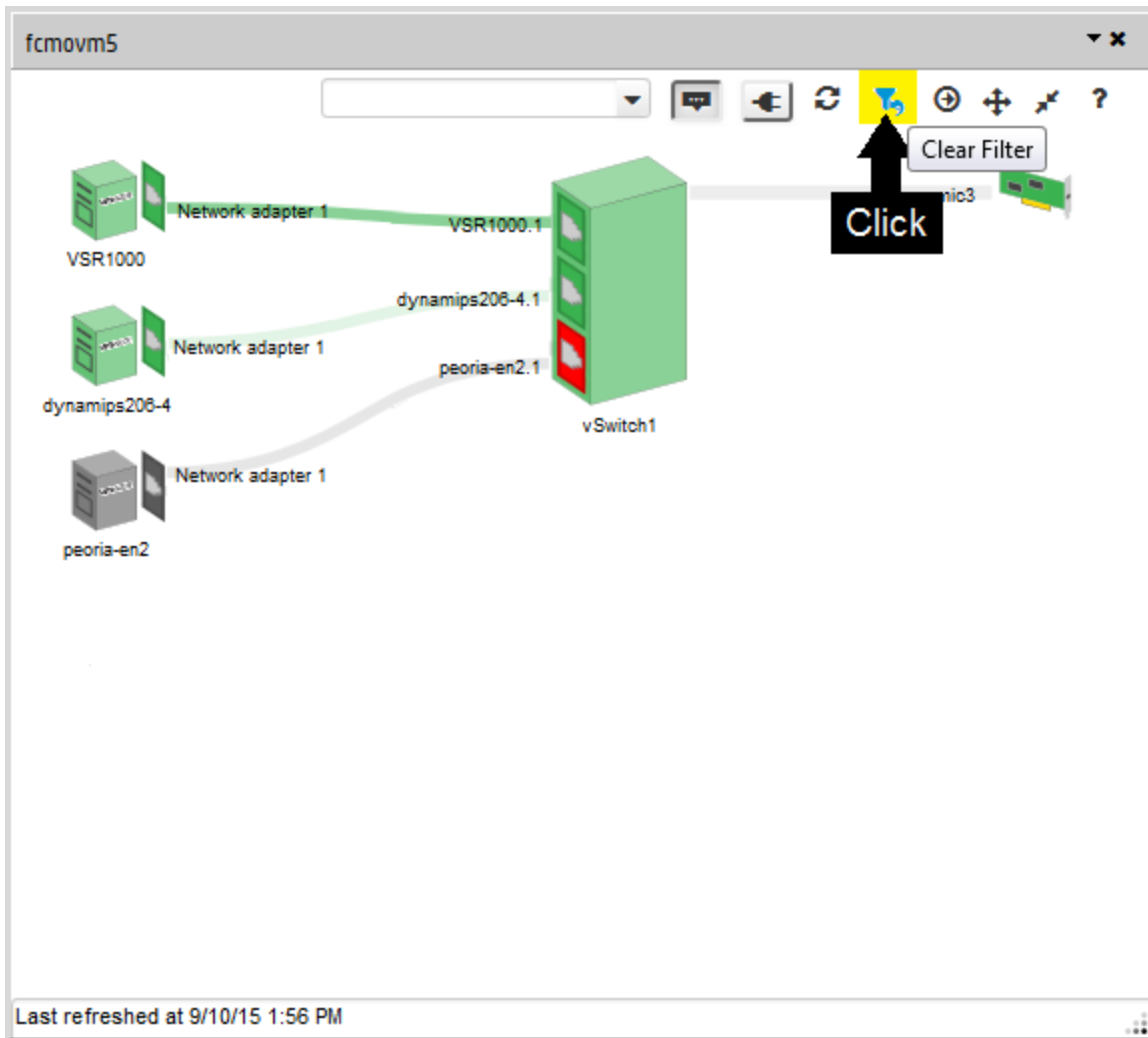

Change Size and Location of the Loom

Left-click the background to establish which point should be considered the new center, and use the mouse to:

- Rotate the mouse wheel to zoom in or zoom out.
- Drag to pan to a new location a short distance within the diagram.
- Pan while maintaining the current highlighted selection (for example follow a highlighted connection line across the diagram):
 - Ctrl + rotate the mouse wheel
 - Ctrl-drag

You can also change the size and location of the popup. NNMI remembers your preferences from session to session (per browser):

Note: When minimized the Loom appears at the bottom of the console window with the hypervisor's name:

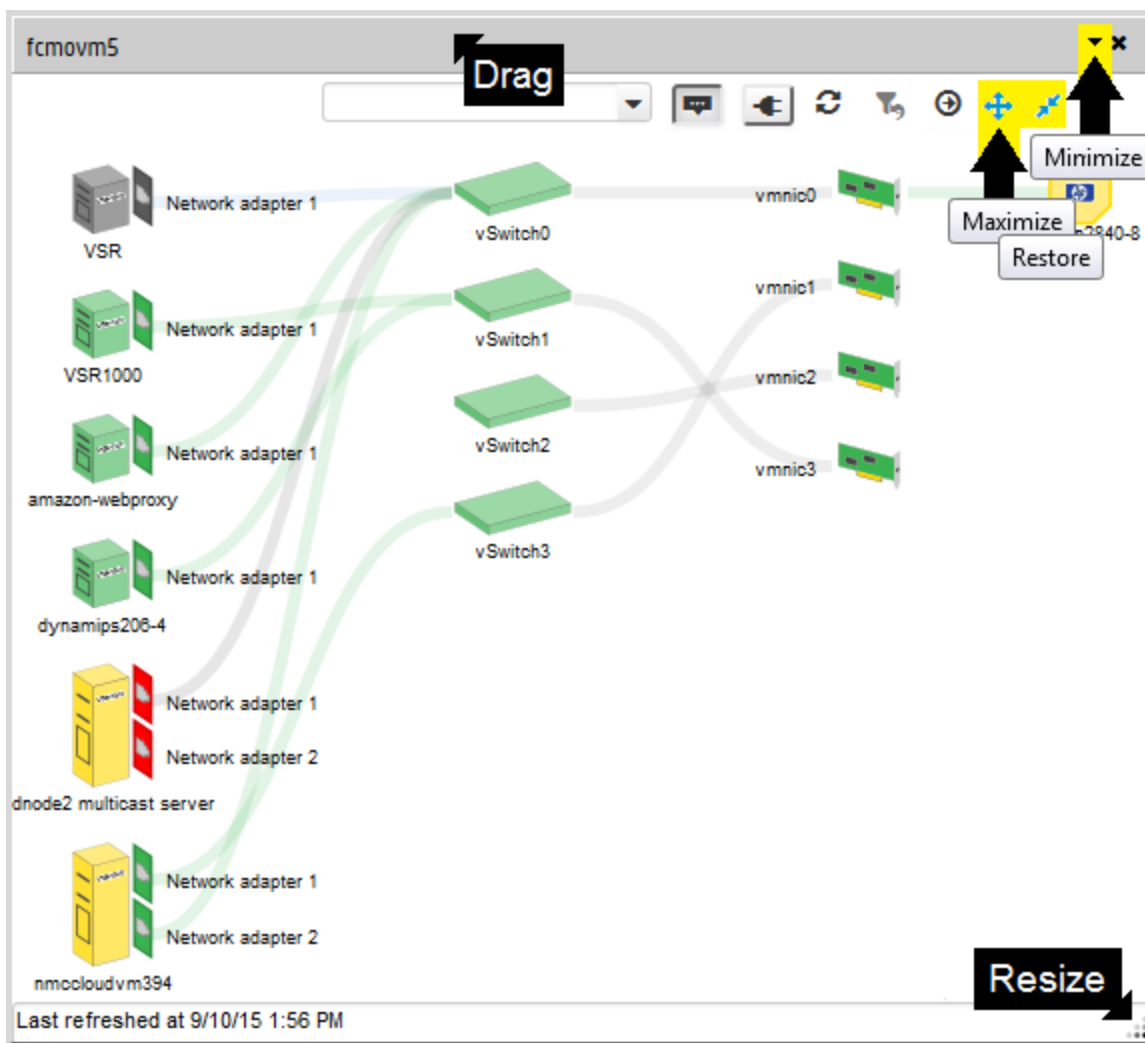

Display Additional Information

- Click any text in the Loom to populate the Analysis Pane in the main console.
- Double-click any text in the Loom to display the node or interface's form in the main console.

Note: When the Loom Dialog is launched from a map view, clicking an object automatically highlights that object on the map. See also ["Using Hypervisor Diagrams and Dialogs" on page 116](#).

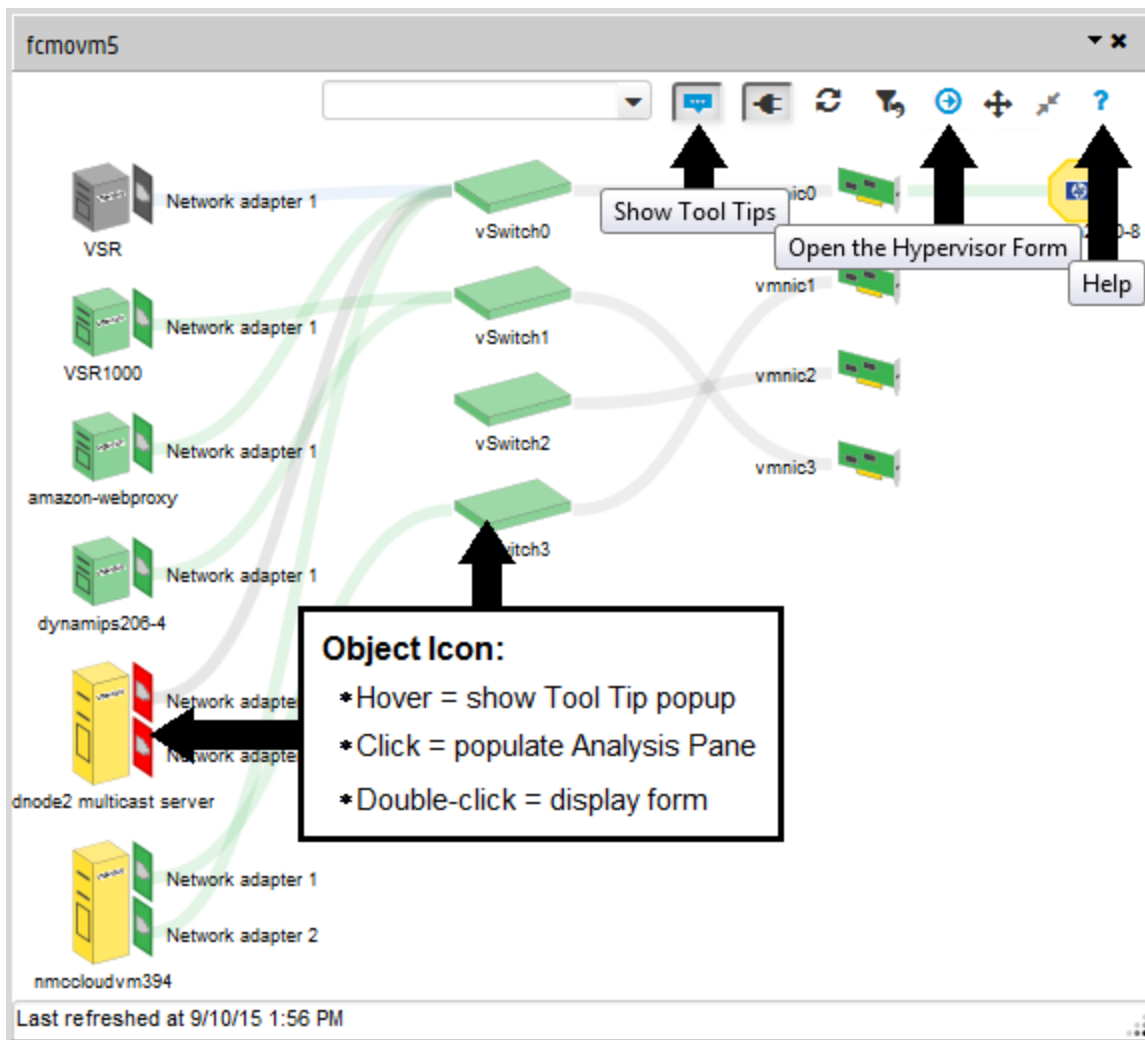

Display devices connected beyond the Loom

1. In the Loom Dialog toolbar, click **Open the Hypervisor Form** to display the Node form in the main console.
2. Use **Actions** → **Maps** → **Layer 2 Neighbor View**.

Tip: In addition to the following, you will see everything else connected to the access Switch.

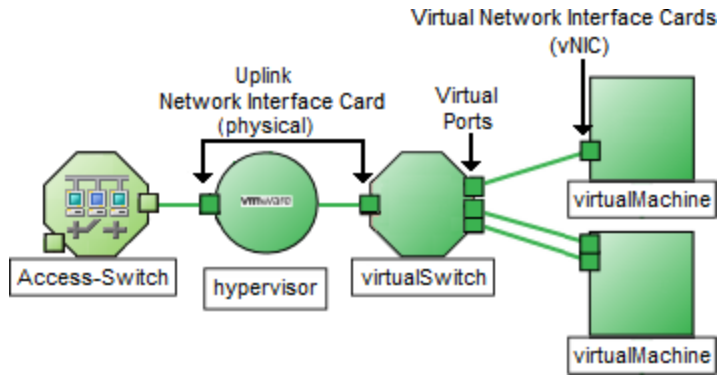







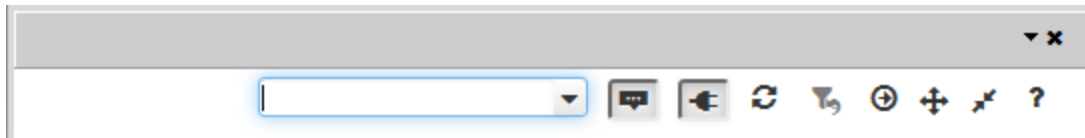

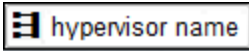













3. In the map toolbar, increase the **Number of Hops** setting to see a wider range of connections.





Toolbar Actions

Toolbar icons are at the top of the Loom Dialog:



Icon	Description
▼	Dock. Minimizes the Loom Dialog into a small rectangular link at the bottom right side of the console's workspace: 
✕	Close. Close the Loom Dialog.
Find	Auto complete pull-down that allows you to pick an item by VM name, VSwitch name, interface name, management address, or IP address:  To highlight the selected object in the diagram, do one of the following: <ul style="list-style-type: none"> • Click a list item • Press enter <div style="background-color: #e0e0e0; padding: 5px; margin-top: 10px;"> Note: If the selected item is not currently visible, NNMi automatically takes the appropriate action: <ul style="list-style-type: none"> • The parent object is expanded to display the selected item. • All powered off items are shown to display the selected item. </div>
 or 	Show Tool Tips. Toggle button to  Enable or  Disable popups showing additional information when you mouse-over an object: <ul style="list-style-type: none"> • Virtual Machines popup shows Name, Management Address, Power State, and System Description

Icon	Description						
	<ul style="list-style-type: none"> • Virtual Switches and Virtual Interfaces popup shows ifName, ifAlias, ifType, and all current IP addresses 						
 or 	<p>Powered-Off VMs. Toggle button to  Show or  Hide all VMs currently with a Power State of Powered Off. See Nodes (All Attributes) view.</p>						
	<p>Refresh. Refreshes the current diagram, showing the most recent virtual configuration and status of each object.</p>						
 or 	<p> The icon is gray when the current loom depicts a hypervisor and all virtual objects being provided by that hypervisor.</p> <p> The icon is black when the current loom depicts a subset of a hypervisor's resources (Virtual Switch, Virtual Interface, or physical interface).</p> <div data-bbox="311 772 714 919" style="border: 1px solid #ccc; padding: 5px; margin: 10px 0;"> <p> Show this only</p> <p>Expand or Collapse this Object</p> <p>Expand or Collapse All in Column</p> </div> <table border="1" data-bbox="311 961 1414 1491"> <tbody> <tr> <td data-bbox="311 961 597 1054">Show this only</td> <td data-bbox="597 961 1414 1054">Simplifies the Loom diagram by hiding anything not directly in communication with the selected object.</td> </tr> <tr> <td data-bbox="311 1054 597 1272">Expand or Collapse this Object</td> <td data-bbox="597 1054 1414 1272"> Does one of the following within the selected parent object: <ul style="list-style-type: none"> • Simplifies the Loom dialog by hiding all child objects (Virtual Ports or Interfaces). • Enhances the Loom dialog by displaying all child objects (Virtual Ports or Interfaces). </td> </tr> <tr> <td data-bbox="311 1272 597 1491">Expand or Collapse All in Column</td> <td data-bbox="597 1272 1414 1491"> Does one of the following within all objects in the column: <ul style="list-style-type: none"> • Simplifies the Loom dialog by hiding all child objects (Virtual Ports or Interfaces). • Enhances the Loom dialog by displaying all child objects (Virtual Ports or Interfaces). </td> </tr> </tbody> </table>	Show this only	Simplifies the Loom diagram by hiding anything not directly in communication with the selected object.	Expand or Collapse this Object	Does one of the following within the selected parent object: <ul style="list-style-type: none"> • Simplifies the Loom dialog by hiding all child objects (Virtual Ports or Interfaces). • Enhances the Loom dialog by displaying all child objects (Virtual Ports or Interfaces). 	Expand or Collapse All in Column	Does one of the following within all objects in the column: <ul style="list-style-type: none"> • Simplifies the Loom dialog by hiding all child objects (Virtual Ports or Interfaces). • Enhances the Loom dialog by displaying all child objects (Virtual Ports or Interfaces).
Show this only	Simplifies the Loom diagram by hiding anything not directly in communication with the selected object.						
Expand or Collapse this Object	Does one of the following within the selected parent object: <ul style="list-style-type: none"> • Simplifies the Loom dialog by hiding all child objects (Virtual Ports or Interfaces). • Enhances the Loom dialog by displaying all child objects (Virtual Ports or Interfaces). 						
Expand or Collapse All in Column	Does one of the following within all objects in the column: <ul style="list-style-type: none"> • Simplifies the Loom dialog by hiding all child objects (Virtual Ports or Interfaces). • Enhances the Loom dialog by displaying all child objects (Virtual Ports or Interfaces). 						
	<p>Open the Hypervisor Form. Displays the hypervisor's form no matter which subset of the hypervisor's resources are currently displayed in the Loom.</p> <div data-bbox="311 1604 1406 1692" style="background-color: #f0f0f0; padding: 5px; margin: 10px 0;"> <p>Tip: Double-click any node or interface label to display that object's form.</p> </div>						
 or 	<p>Maximize.</p> <p> The icon is black when clicking will make the Loom Dialog is as large as possible, filling all space currently available within the NNMi console window.</p> <p> The icon is gray when the loom is already maximized. See  Restore (below).</p>						

Icon	Description
	Restore. Reverts the dialog to the size and settings prior to clicking  Maximize .
	Help. Click the icon for access to the Loom Dialog Help.
	Resize: <ol style="list-style-type: none">1. Click the Loom Dialog's title bar and move it to the desired location within the console.2. Drag the bottom right corner  to resize the dialog to the preferred size. <p>Note: NNMi remembers your preference for size and location (stored in your browser settings).</p>

Chapter 8: About the Analysis Pane

The Analysis Pane displays related details about the selected object. NNMi performs the appropriate analysis on the selected object to determine the most important information to display. Any hyperlink within the Analysis Pane displays more information about the selected detail.

For example: When you select an Incident, the Analysis Pane might include important details about the incident's Source Node and Source Object. When you select a Node, the Analysis Pane might include important information about the node's Interfaces and IP Addresses.

1. • **Access the Analysis Pane from a table view:**

- i. Select the workspace of interest (for example,  **Inventory**).
- ii. Select the view that contains the object of interest (for example, the **Nodes** view).
- iii. Select the row that contains the object of interest.
- iv. NNMi displays detailed information at the bottom of the view in the Analysis Pane.

• **Access the Analysis Pane in a map view:**

- i. Select the workspace of interest (for example,  **Topology Maps**).
- ii. Select a map view (for example, select **Routers**).

Note: If the map requires a starting node before it opens, enter the name or IP Address for the starting node you want to use.

- iii. Click the map object of interest.
- iv. NNMi displays detailed information at the bottom of the view in the Analysis Pane.

• **Access the Analysis Pane in a form:**

- Click the form's toolbar  Show Analysis icon to display information about the current form's top-level object in the Analysis Pane.

Note:  Show Analysis always displays the top-level object's information.

- Click a row in a table on one of the form's tabs to display detailed information about the selected object in the Analysis Pane.

NNMi displays detailed information at the bottom of the form in the Analysis Pane. See [Working with Objects](#) for more information about forms.



2. Open the Analysis Pane if necessary by clicking the  expand button in the Analysis Pane banner bar:



If you change views, NNMi clears the Analysis Pane. The Analysis Pane remains blank unless an object is selected.

If you select multiple objects, the Analysis Pane displays data about the first selected object.

3. Using the Analysis Pane:

- To resize, place your mouse cursor over the title bar to display the \updownarrow symbol and drag to adjust the size.
- To refresh a subset of information in the Analysis Pane, click any displayed  Refresh icon .
To refresh all data in the Analysis Pane, open the object's form and click  Refresh or  Save.
- To launch an SNMP Line Graph for the selected metric, click the icon that appears at the bottom of each gauge.
- To select and copy the tooltip information, double-click the gauge. NNMi opens a text window that enables you to select and copy the tooltip information.
- The Gauges tab shows real-time SNMP gauges to display State Poller and Custom Poller SNMP data.
 - These gauges are displayed for Nodes, Interfaces, Custom Node Collections, and for Node Sensors of type CPU, Memory, or Buffers, and Physical Sensors of type Backplane.
 - NNMi displays a gauge for each significant MIB Object Identifier (OID) that the node or interface supports, up to the default maximum of 24.

Tip: If you are an NNMi administrator, for information about using the `nms-ui.properties` file to change this default, see the "NNMi Console" chapter in the *HPE Network Node Manager i Software Deployment Reference*, which is available at:
<http://softwaresupport.hpe.com>.

- Each gauge displays the current OID value, using the default refresh rate of 15 seconds.

Tip: If you are an NNMi administrator, for information about using the `nms-ui.properties` file to change this default, see the "NNMi Console" chapter of the *HPE Network Node Manager i Software Deployment Reference*, which is available at:
<http://softwaresupport.hpe.com>.

- The value range displayed indicates the OID minimum and maximum values that NNMi has encountered.
- For any gauge that tracks percentage values, NNMi uses a red line to indicate where the OID value is near 100 percent.
- There is not a one-to-one match between the OIDs used to analyze monitoring thresholds and those displayed in the Analysis Pane. For example, the Analysis Pane might display a **Cisco Memory Pool** OID value that does not match the value used to calculate whether the **Memory Utilization** Monitored Attribute threshold is reached or exceeded. This is because some threshold metrics require more complex calculations than a single OID allows.
If a gauge label appears to be a duplicate value, mouse over the label to view the more complete tooltip name that appears.

Tip: If you are an NNMi administrator, to change the gauge title - for example, to the SNMP MIB variable name - see the "Maintaining NNMi" chapter of the *HPE Network Node Manager i Software Deployment Reference*, which is available at:
<http://softwaresupport.hpe.com>.)

Tip: Some views are also accessible from the console's **Actions** menu. See "[Using Actions to Perform Tasks](#)" on [page 173](#) for more information. You can also right-click any object in a table or map view to access the items available within the **Actions** menu.

For more information about the types of information displayed, see [Use the Analysis Pane](#).

Related Topics

["Use Table Views" on page 63](#)

["Use Map Views" on page 84](#)

Chapter 9: Using the View Toolbars

NNMi provides toolbars for the following types of views:

- [Table views toolbar](#)
- [Node Group Map views toolbar](#)
- [Neighbor views toolbar](#)
- [Path View toolbar](#)
- [Network Overview toolbar](#)

Table View Toolbar

This is the table view display panel toolbar:

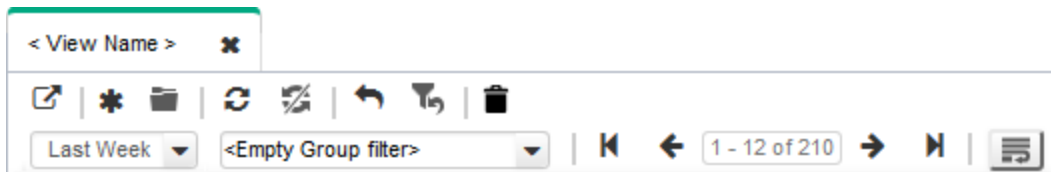









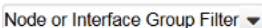

Use the table view toolbar to perform the following tasks within the displayed view.

View Toolbar Icons

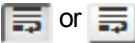
Icon	Description
	Show View in New Window. Displays the current view in a new window.
	New. <i>NNMi Administrators only.</i> Opens the form to create a new object instance.
	Open. Displays the form for the selected object. See " Access Object Information (Forms and Analysis Pane) " on page 12.
	Refresh. Refreshes the current view. See " Refresh a View " on page 58 for more information. Restarts periodic refresh if it has been disabled.
	Stop Periodic Refresh. Temporarily disables the periodic refresh of a view. See " Stop Periodic Refresh of a View " on page 66 for more information.
	Restore Default Settings. Resets default settings, including the resizing of table columns, sort selections, and filters. Any hidden columns are restored to the view. See " Hide a Column " on page 64.
	Restore Default Filters. Clears any currently applied filters. See " Filter a Table View " on page 67.
	Delete. If your role permits, deletes the selected object instance and

View Toolbar Icons, continued

Icon	Description
	any objects contained in that object. For example, deleting a node also deletes the interface and address instances associated with that node, and the history of those objects.
	Selects a time period filter. This filter only appears in incident views.
	Selects an available node group or interface group filter.
 <p>The page controls only appears when viewing tables. They let you page through table information by rows.</p> <p>Use  Previous or [Page Up] to move up one page.</p> <p>Use  Next or [Page Down] to move down one page.</p> <p>Use  First or [Home] to move to the top of the table.</p> <p>Use  Last or [End] to move to the end of the table.</p> <div style="background-color: #e0e0e0; padding: 10px; margin-top: 10px;"> <p>Tip: Use the keyboard's keys:</p> <ul style="list-style-type: none"> • [↑] up arrow key to scroll up one row. • [↓] down arrow key to scroll down one row. • [page up] and [page down] keys to scroll through the total number of rows in the current table. </div> <div style="background-color: #e0e0e0; padding: 10px; margin-top: 10px;"> <p>Note: In the Table status bar: Total value displays the number of rows in the current table. If the table row count exceeds the maximum table size specified by NNMi, the Total value is followed by the limit set for the table. If the limit is exceeded:</p> <ul style="list-style-type: none"> • Each time you refresh the table view or update the table filter, NNMi computes the actual number of rows in the table. • When you scroll to the last row of the table, NNMi displays a dialog explaining that the table is larger than the specified limit and recommending that you filter the table view. See "Filter a Table View" on page 67 for more information about how to filter a table view. </div>	
	<p>Text Wrap:</p> <ul style="list-style-type: none"> •  Off = Each row is one text line high. Any text too wide for the column width disappears from view. •  On = Each row becomes deep enough to show the entire text string (as many lines of text as necessary).
 (view name tab)	<p>Close. Close the current view.</p>

Node Group Map Toolbar

This is the Node Group Map display panel toolbar:











The Node Group Map view toolbar lets you perform the following tasks within the displayed map.

Node Group Map Toolbar Icons

Icon	Description
	Show View in New Window. (Only available from the main console.) Displays the current view in a new window.
	Open. Displays the form for the selected object. See "Access Object Information (Forms and Analysis Pane)" on page 12.
	<p>Open Node Group Map. Opens the Node Group Map for the selected <i>Child</i> Node Group. The <i>Child</i> Node Group map replaces the current map and displays each node within the <i>Child</i> Node Group.</p> <p>Note: You can also double-click the Node Group symbol to open the <i>Child</i> Node Group Map.</p> <p>See "About Node and Interface Groups" on page 70 for more information about Node Groups.</p>
	<p>Save Map. Saves the current position of each of the nodes on the current Node Group Map.</p> <p>Note: Each time you use this option, any previous location information is deleted.</p>
	Refresh. Refreshes the current view. See "Refresh a View" on page 58 for more information.
	Refresh Status. Refreshes only the status of each node in the map. See "Refresh Node Status on a Map" on page 112 for more information.
	Fit Content. Adjusts the size of the node symbols so that all members of the Node Group fit within the current window. See "Adjust the Zoom Factor" on page 109 for more information.
	Actual Size. Cancels any current zoom setting. See "Adjust the Zoom Factor" on page 109 for more information.
	Zoom Out. Zooms out 25% of current size. See "Adjust the Zoom Factor" on page 109 for more information.
	Zoom In. Zooms in 25% of current size. See "Adjust the Zoom Factor" on page 109 for more information.
 or 	Find. Toggles on or off highlighting the identified Node in the current map and ensures that node is in the map's display area. See "Find a Node in a Map" on page 112.

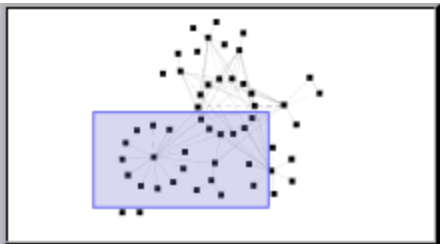
Node Group Map Toolbar Icons , continued

Icon	Description
 or 	Indicate Key Incidents. Toggles on or off NNMi's enlarging any map symbol that has an associated Key Incident ¹ . See " Node Group Map Objects " on page 98 for more information.
 or 	Tool Tips. Toggles on or off Tool Tips information that pops up when the mouse cursor is placed over an object on a map. See " Control Tool Tips Information on a Map " on page 113 for more information.
 or 	Overview Location. Pops up a dialog of choices for placement of the Overview Pane (used to pan around on the map). See " Pan Around the Map " on page 110:
	<div style="border: 1px solid black; padding: 5px;"> Where should the Map Overview appear? <input type="radio"/> Hidden <input type="radio"/> Top Right <input type="radio"/> Top Left <input type="radio"/> Bottom Right <input type="radio"/> Bottom Left </div> <p>For more information, see "Set the Location of the Overview Pane" on page 111.</p>
 (view name tab)	Close. Close the current view.

Neighbor View Toolbar

This is the neighbor view display panel toolbar:

















The neighbor view toolbar lets you perform the following tasks within the displayed view.

Neighbor View Toolbar Icons

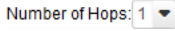

Icon	Description
	Show View in New Window. (Only available from the main console.) Show View in New Window. Displays the current view in a new window.

¹Incidents with both: (1) Severity = other than Normal. (2) Correlation Nature = equal to Root Cause, Service Impact, Stream Correlation, Rate Stream Correlation, Info, or None.

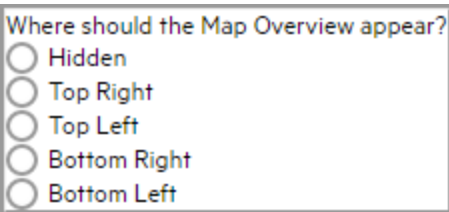
Neighbor View Toolbar Icons, continued

Icon	Description
	Open. Displays the form for the selected object. See "Access Object Information (Forms and Analysis Pane)" on page 12.
	Refresh. Refreshes the current view. See "Refresh a View" on page 58 for more information.
	Refresh Status. Refreshes only the status of each node in the map. See "Refresh Node Status on a Map" on page 112 for more information.
	Fit Content. Adjusts the size of the node symbols so that all members of the Node Group fit within the current window. See "Adjust the Zoom Factor" on page 109 for more information.
	Actual Size. Cancels any current zoom setting. See "Adjust the Zoom Factor" on page 109 for more information.
	Zoom Out. Zooms out 25% of current size. See "Adjust the Zoom Factor" on page 109 for more information.
	Zoom In. Zooms in 25% of current size. See "Adjust the Zoom Factor" on page 109 for more information.
	Specify the starting node for the neighbors you want to map. Populate this field with the current value of the node's Name attribute or one of the Node's IP addresses. Note: As you type, NNMi provides a selection list of all current valid entries matching your criteria. You must use one of the suggested values.
	Select the number of hops to be displayed within the map view. A hop is a node representing any network device, such as a workstation, gateway, or switch, which is connected by a link with no intermediate nodes.
 or 	Find. Toggles on or off highlighting the identified Node in the current map and ensures that node is in the map's display area. See "Find a Node in a Map" on page 112.
 or 	Tool Tips. Toggles on or off Tool Tips information that pops up when the mouse cursor is placed over an object on a map. See "Control Tool Tips Information on a Map" on page 113 for more information.
 or 	Overview Location. Pops up a dialog of choices for placement of the Overview Pane (used to pan around on the map). See "Pan Around the Map" on page 110:  For more information, see "Set the Location of the Overview Pane" on

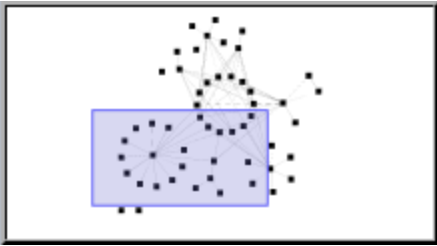
Neighbor View Toolbar Icons, continued

Icon	Description
	page 111.
 (view name tab)	Close. Close the current view.





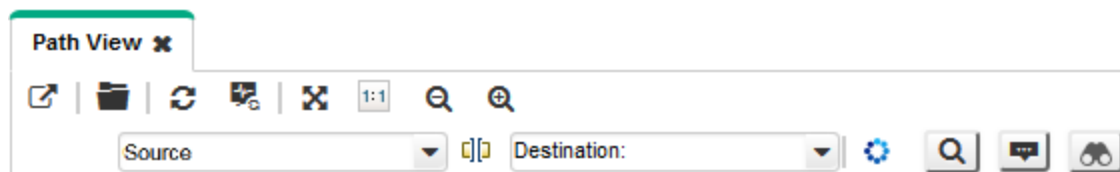



Path View Toolbar

This is the Path View display panel toolbar:







The Path View toolbar lets you perform the following tasks within the displayed view.



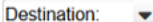

Path View Toolbar Icons

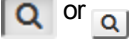
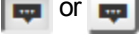
Icon	Description
	Show View in New Window. (Only available from the main console.) Displays the current view in a new window.
	Open. Displays the form for the selected object. See "Access Object Information (Forms and Analysis Pane)" on page 12.
	Refresh. Refreshes the current view. See "Refresh a View" on page 58 for more information.
	Refresh Status. Refreshes only the status of each node in the map. See "Refresh Node Status on a Map" on page 112 for more information.
	Fit Content. Adjusts the size of the node symbols so that all members of the Node Group fit within the current window. See "Adjust the Zoom Factor" on page 109 for more information.
	Actual Size. Cancels any current zoom setting. See "Adjust the Zoom Factor" on page 109 for more information.
	Zoom Out. Zooms out 25% of current size. See "Adjust the Zoom Factor" on page 109 for more information.
	Zoom In. Zooms in 25% of current size. See "Adjust the Zoom Factor" on page 109 for more information.

Path View Toolbar Icons, continued

Icon	Description
	<p>more information.</p>
	<p>Specify the source node to be used in the Path View.</p> <p>Caution: Do not specify a node that is a switch.</p> <p>Populate this field with the current value of the node's Hostname attribute (<i>case-sensitive</i>) or one of the node's IPv4 addresses. These are the values from the Node form.</p> <p>Note: As you type, the auto-complete feature displays a list of possible matches. Select any item from the list.</p> <p>(<i>NNMi Advanced</i>) Path View works only with IPv4 addresses. The NNMi Advanced IPv6 address values are not valid choices for Path View. Any devices in your network that are configured with IPv6 addresses cannot be displayed on Path View maps.</p>
	<p>Swap Nodes. Swaps the source and destination nodes in the Path View.</p>
	<p>Specify the destination node in the Path View.</p> <p>Caution: Do not specify a node that is a switch.</p> <p>Populate this field with the current value of the node's Hostname attribute (<i>case-sensitive</i>) or one of the node's IPv4 addresses. These are the values from the Node form.</p> <p>Note: As you type, the auto-complete feature displays a list of possible matches. Select any item from the list.</p> <p>(<i>NNMi Advanced</i>) Path View works only with IPv4 addresses. The NNMi Advanced IPv6 address values are not valid choices for Path View. Any devices in your network that are configured with IPv6 addresses cannot be displayed on Path View maps.</p>
	<p>Compute Path. Computes the Path View.</p> <p>Note: Also use this icon to re-compute the Path View.</p>
	<p>Find. Toggles on or off highlighting the identified Node in the current map and ensures that node is in the map's display area. See "Find a Node in a Map" on page 112.</p>
	<p>Tool Tips. Toggles on or off Tool Tips information that pops up when the mouse cursor is placed over an object on a map. See "Control Tool Tips Information on a Map" on page 113 for more information.</p>

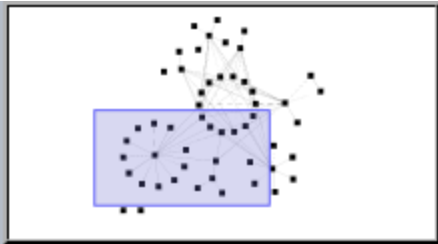
Path View Toolbar Icons, continued

Icon	Description
 or 	<p>Overview Location. Pops up a dialog of choices for placement of the Overview Pane (used to pan around on the map). See "Pan Around the Map" on page 110:</p>  <div data-bbox="971 310 1417 510" style="border: 1px solid black; padding: 5px;"> <p>Where should the Map Overview appear?</p> <p><input type="radio"/> Hidden</p> <p><input type="radio"/> Top Right</p> <p><input type="radio"/> Top Left</p> <p><input type="radio"/> Bottom Right</p> <p><input type="radio"/> Bottom Left</p> </div> <p>For more information, see "Set the Location of the Overview Pane" on page 111.</p>
 (view name tab)	<p>Close. Close the current view.</p>





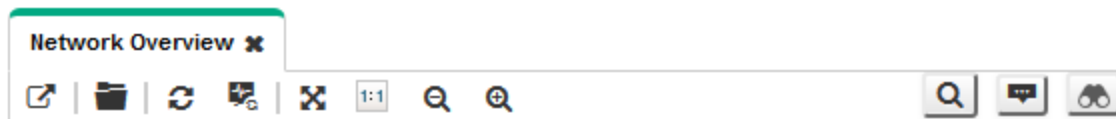

Network Overview Toolbar

This is the Network Overview display panel toolbar:











The Network Overview toolbar lets you perform the following tasks within the displayed view.

Network Overview Toolbar Icons

Icon	Description
	<p>Show View in New Window. (Only available from the main console.) Displays the current view in a new window.</p>
	<p>Open. Displays the form for the selected object. See "Access Object Information (Forms and Analysis Pane)" on page 12.</p>
	<p>Refresh. Refreshes the current view. See "Refresh a View" on page 58 for more information.</p>
	<p>Refresh Status. Refreshes only the status of each node in the map. See "Refresh Node Status on a Map" on page 112 for more information.</p>
	<p>Fit Content. Adjusts the size of the node symbols so that all members of the Node Group fit within the current window. See "Adjust the Zoom Factor" on page 109 for more information.</p>
	<p>Actual Size. Cancels any current zoom setting. See "Adjust the Zoom Factor" on page 109 for more information.</p>
	<p>Zoom Out. Zooms out 25% of current size. See "Adjust the Zoom Factor" on page 109 for more information.</p>

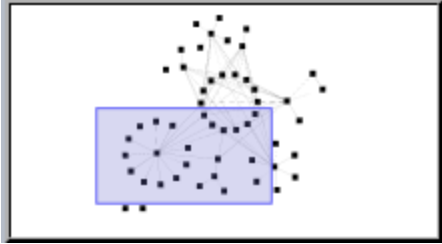
Network Overview Toolbar Icons, continued

Icon	Description
	<p>Zoom In. Zooms in 25% of current size. See "Adjust the Zoom Factor" on page 109 for more information.</p>
 or 	<p>Find. Toggles on or off highlighting the identified Node in the current map and ensures that node is in the map's display area. See "Find a Node in a Map" on page 112.</p>
 or 	<p>Tool Tips. Toggles on or off Tool Tips information that pops up when the mouse cursor is placed over an object on a map. See "Control Tool Tips Information on a Map" on page 113 for more information.</p>
 or 	<p>Overview Location. Pops up a dialog of choices for placement of the Overview Pane (used to pan around on the map). See "Pan Around the Map" on page 110:</p> <div data-bbox="297 825 735 1066" style="border: 1px solid black; padding: 5px; margin: 10px 0;">  </div> <div data-bbox="971 709 1417 909" style="border: 1px solid gray; padding: 5px; margin: 10px 0;"> <p>Where should the Map Overview appear?</p> <p><input type="radio"/> Hidden</p> <p><input type="radio"/> Top Right</p> <p><input type="radio"/> Top Left</p> <p><input type="radio"/> Bottom Right</p> <p><input type="radio"/> Bottom Left</p> </div> <p>For more information, see "Set the Location of the Overview Pane" on page 111.</p>
 (view name tab)	<p>Close. Close the current view.</p>

Chapter 10: Using the Form Toolbar









This is the form toolbar:



If your role permits, the toolbar lets you perform the following tasks within the form. The group of available actions can change from form to form:

Tip: You can also right-click any object in a table or map view to access the items available within the **Actions** menu.

Form Toolbar Icon Actions

Icon	Action
	Show Form in New Window. Displays the current form in a new window. Note: NNMi closes the current form before displaying the form in a new window.
	Show Analysis. Displays the Analysis Pane information for the current form. See " About the Analysis Pane " on page 156 for more information.
	Save. Saves the current form.
	Save and New. Saves the current form, and opens a new empty form where you can create a new object instance.
	Save and Close. Saves and closes the current form.
	Refresh. Refreshes the data in the current form.
	Delete. Deletes the selected object instance and any objects contained in that object. For example, deleting a node also deletes the interface and address instances associated with that node, and the history of those objects. Note: When you delete an object instance that is created using a filter, such as a Node Group or Interface Group, NNMi deletes only the Node or Interface Group filter. NNMi does not remove the nodes or interfaces that belong to the selected group.
	Close. Closes the current form.

Related Topics

["Access Object Information \(Forms and Analysis Pane\)" on page 12](#)

Chapter 11: Working with Objects

Objects are database records of information about your environment and events that occur within it. Each type of object represents a particular kind of information. For example, incident objects represent situations or events that arise in your environment.

An object is defined by its attributes. For example, an incident object includes a status attribute and a source node (among many others). Different object types have different amounts and types of attributes. Some attribute values are simple things, such as numbers and text strings. Other attribute values are more complex, such as a reference to a related object. For example, when an SNMP Agent attribute appears in a Node form, it represents the SNMP Agent that is related to the selected node.

If more than one of a certain type of object can be related to the selected object (for example, incidents related to a node), the form contains a tab that displays a table with the entire list of related objects.

A *view* is a collection of related objects that are depicted graphically as a table or map. A *form* provides all stored attributes about a selected object. The attributes on the form can be attributes of the selected object or related objects.

Operations that can be performed on objects are called actions. Actions are simply shortcuts to simple or complex tasks. A particular action can be associated with a specific object type. For example, when displaying a node table view, you might want to open a map showing all of that node's Layer 2 neighbors.

Tip: You can also right-click any object in a table or map view to access the items available within the **Actions** menu.

To access an object's form from a table view:

Double-click the row representing an object.

NNMi displays the form for the selected object.

To access an object's form from a map view:

Do one of the following:

- Select the node of interest and click the  Open icon.
- In most cases, double-click the object of interest.

Note: If the map object is a Child Node Group, double-clicking the Child Node Group object replaces the current map with a map of the nodes in the Child Node Group. To access a Child Node Group form, select the Child Node Group object and click the  Open icon. See "Help for Operators" for more information.

NNMi displays the form for the selected object.

A red asterisk (*) that precedes an attribute on a form indicates the attribute requires a value.

From an object form, you can:

["Modify Object Attribute Values" on page 171](#)

["Access All Information About a Related Object" on the next page](#)

["Access a Subset of the Available Information About a Related Object" below](#)

Access a Subset of the Available Information About a Related Object



While investigating the available information for an object (within that object's form), some information represents attributes of the object itself and some information is about related objects. The related objects are indicated by a  Lookup icon. For example, when viewing information for an Interface object, you can access information about the Node in which that interface resides.

A red asterisk (*) that precedes an attribute on a form indicates the attribute requires a value.

This is an example Lookup Field:



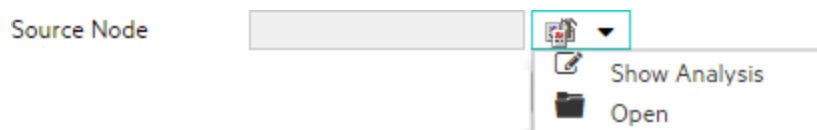

To display a subset of information about a related object from within a form:

1. Locate the field for the related object that you want to learn more about.
2. Click the  Lookup icon, and select  **Show Analysis** from the drop-down menu.



3. The Analysis Pane appears showing information about the related object. See ["About the Analysis Pane" on page 156](#) for more information.

Note: NNMi displays only the information that the NNMi Security configuration permits you to access. See [Determine which NNMi Role to Assign](#) in "Help for Administrators" for more information.

4. Mouse-over any  Refresh icon to see the last time the details were updated.
Click any  Refresh icon to gather the most recent data.

Access All Information About a Related Object

While investigating the details for one object using a form, you can access information about another related object. For example, when viewing all information stored for a node, you can access all available information for an interface for that node to determine the interface status.

A red asterisk (*) that precedes an attribute on a form indicates the attribute requires a value.



You can open another form from within a form for any object that is contained in the form you are viewing.

Such objects are indicated using a  Lookup icon.

This is an example Lookup Field:



To open another form from within a form:

1. Locate the field of an object about which you want to see more information.
2. Click the  Lookup icon, and select  **Open** from the drop-down menu.

A new form appears showing all of the attributes for that object. Any default values specified for the object are pre-populated in the form

Modify Object Attribute Values

When viewing details for an object, such as a node, subnet, or interface, you can change one or more of its attribute values. For example, you can add notes to an incident to explain steps that were taken to date to resolve the problem. Until the problem is resolved you can enter information related to a workaround. Finally, after a solution is determined, you can add information describing how the problem was resolved.

Note: If you have Guest user role, you cannot modify any attributes.

Two kinds of fields indicate that you can modify an attribute.

A red asterisk (*) that precedes an attribute on a form indicates the attribute requires a value.



To modify information in a text box:

1. Move your cursor to the modifiable field of interest.
2. Type the new value. For example, the Notes attribute is a modifiable field:

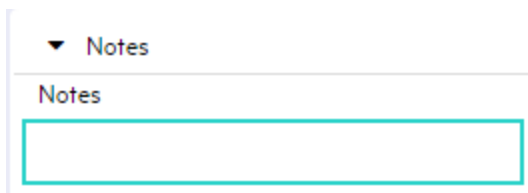
Tip: If the attribute appears to be a modifiable field, but it does not permit text entry, it is a memo field.



Tip: Click the attribute label to access a dialog box that enables you to view or edit text. Using this feature, you can insert more text or view a text field that is longer than the original display area.

3. When you are finished with your edits:
 - Click  **Save** to save your changes.
 - Click  **Save and Close** to save your changes and close the form.

To modify information in a Lookup field:

1. Look for this icon to the right of a text box . For example:



2. Do one of the following:

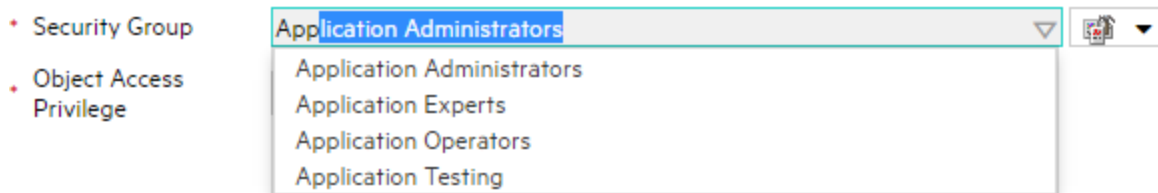

- Start to type into the text box. NNMi displays a list of all valid choices. You can select from the list to complete your choice.

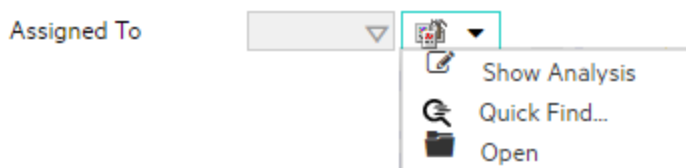

- Click the  Lookup icon, and choose  Quick Find to display a list of valid choices:



3. When you are finished with your edits:

- Click  **Save** to save your changes.
- Click  **Save and Close** to save your changes and close the form.

Chapter 12: Using Actions to Perform Tasks

Actions let you perform operations on selected items. The actions available to you depend on your NNMi user role. Administrators have more action choices than operators. If SPIs are installed in your environment, the list of actions could expand. Some Actions change an object's attribute value or require log on access to a node (for example, telnet).

See the [NNMi Actions](#) table for a description of possible actions.

To perform any of the actions described, you select an action from the **Actions** menu. The **Actions** menu is accessible from the NNMi console main menu bar and from the menu bar in any form or view that is opened in a new window. See ["Invoke Actions" on page 12](#) for more information about how to access actions.

NNMi Actions

Action	Description
Layer 2 Neighbor View	Maps → Layer 2 Neighbor View Displays a map of the Layer 2 network. Layer 2 maps help you better understand your switch connectivity. See "Help for Operators" for more information.
Layer 3 Neighbor View	Maps → Layer 3 Neighbor View Displays a map of the Layer 3 network. Layer 3 network maps help you better understand your router connectivity. See "Help for Operators" for more information.
Path View	Maps → Path View Displays a map showing the route between two specified nodes. The Source and Destination nodes should not be switches. Note: (<i>NNMi Advanced</i>) Path View works only with IPv4 addresses. The NNMi Advanced IPv6 address values are not valid choices for Path View. Any devices in your network that are configured with IPv6 addresses cannot be displayed on Path View maps.
MPLS WAN Clouds Map	(<i>NNMi Advanced</i> , plus <i>HPE Route Analytics Management System (RAMS) for MPLS WAN</i>) Displays a map of the Layer 3 connectivity across MPLS WAN Clouds. See "Help for Operators" for more information. If you are an NNMi administrator, see HPE RAMS MPLS WAN Configuration (NNMi Advanced) for information about configuring RAMS.

NNMi Actions Specific to Incidents

Action	Description
Interface Actions	<p>Only available for incidents that have a Source Object that is an interface.</p> <p>Provides access to all of the actions available for an interface. See Actions Specific to Nodes, Interfaces, and IP Addresses for more information about the actions available for interfaces.</p>
IP Address Actions	<p>Only available for incidents that have a Source Object that is an IP address.</p> <p>Provides access to all of the actions available for an IP address. See Actions Specific to Nodes, Interfaces, and IP Addresses for more information about the actions available for IP addresses.</p>
Node Actions	<p>Provides access to all of the actions available for a node. See Actions Specific to Nodes, Interfaces, and IP Addresses for more information about the actions available for nodes.</p> <p>The action is applied to the incident's Source Node.</p>
Node Group Members	<p><i>Island Node Group incidents only.</i> Displays a table of the nodes that are members of the Island Node Group that is the Source Object for the selected incident.</p> <p>An Island Group is a group of fully-connected nodes discovered by NNMi, and NNMi determines this group is not connected to the rest of the topology.</p> <div style="background-color: #e0e0e0; padding: 5px;"> <p>Note: Incidents that have a Source Object that is an Island Node Group include Remote site in the incident message.</p> </div>
Node Group Map	<p>Maps → Node Group Map</p> <p>Displays the lowest level Node Group map to which the Source Node belongs. For example, if the node belongs to a Child Node Group, the Child Node Group displays.</p> <p>If the Source Node is a member of more than one Node Group at the lowest level, NNMi prompts you to select the Node Group map you want to display.</p> <p>If the incident's Source Object is an Island Node Group, NNMi displays the Island Node Group map.</p> <p>An Island Group is a group of fully-connected nodes discovered by NNMi, and NNMi determines this group is not connected to the rest of the topology.</p> <div style="background-color: #e0e0e0; padding: 5px;"> <p>Note: Incidents that have a Source Object that is an Island Node Group include Remote site in the incident message. See "Help for Operators" for more information.</p> </div> <p>When the selected Source Node is not a member of any Node Group, and you select the Node Group Map action, NNMi displays an information message.</p>
Source Node	Opens the Node form for the Source Node of the current incident.
Source Object	Opens the Source Object's form for the current incident. For example, if the Source

NNMi Actions Specific to Incidents, continued

Action	Description
	Object is a Layer 2 Connection, NNMi opens the Layer 2 Connection form.
Graph Custom Poller Results	Graphs all MIB expressions from each of the Custom Poller Collections associated with the selected incident's Source Node.

Actions Specific to Nodes, Interfaces, and IP Addresses

Action	Description
Node Group Map	<p>Maps → Node Group Map</p> <p>This action displays the lowest level Node Group map to which the Source Node, or selected interface or IP address on a node belongs. For example, if the node belongs to a Child Node Group, the Child Node Group displays.</p> <p>If the Source Node, or selected interface or IP address on a node is a member of more than one Node Group at the same level, NNMi prompts you to select the Node Group map you want to display.</p> <p>When the selected Source Node, interface, or IP address is not a member of any Node Group, and you select the Node Group Map action, NNMi displays an information message.</p>
Graphs	<p>Graphs in real time the SNMP data configured to be displayed for the selected nodes or interfaces. The graph name should help to identify the type of data in the graph.</p> <p>NNMi provides a set of Line Graphs. See "Help for Operators" for more information. An NNMi administrator or HPE Network Node Manager i Software Smart Plug-ins (iSPIs) might configure additional Line Graphs that appear in the Actions menu list.</p>

Actions Provided for Node Groups

Action	Description
Node Group Map	<p>Maps → Node Group Map</p> <p>Displays a current map of all nodes that belong to the selected Node Group.</p>
Preview Members	<p>Node Group Details → Preview Members (Current Group Only).</p> <p>Displays a list of all nodes that belong to the selected Node Group.</p>
Show Members	<p>Node Group Details → Show Members (Include Child Groups).</p> <p>Displays a list of all nodes that belong to the selected Node Group as well as all of its Child Node Groups. .</p>
Show All Incidents	<p>Node Group Details → Show All Incidents</p> <p>Checks for any Incidents associated with the selected Node Group.</p>
Show All Open Incidents	<p>Node Group Details → Show All Open Incidents</p> <p>Checks for any open Incidents associated with the selected Node Group.</p>

Actions Provided for Node Groups , continued

Action	Description
Status Details	Node Group Details → Status Details Displays a report about the status of all members of the selected Node Group.

Actions Provided for Node Group Maps

Action	Description
Open Node Group Map	Displays the selected Node Group map.
Open Node Group Map Settings	Opens the Node Group Map Settings form for the selected Node Group map. See Define Node Group Map Settings for more information.

Actions Provided for Interface Groups

Action	Description
Show Members	Node Group Details → Show Members Displays a list of all nodes that belong to the selected interface Group.

Actions Specific to Custom Polled Instances

Action	Description
Graph Polled Instance	Graphs the line representing the Custom Poll results for the selected Custom Polled Instance.

NNM iSPI Performance for Metrics Actions

Requires HPE Network Node Manager iSPI Performance for Metrics Software (NNM iSPI Performance for Metrics). To populate performance data in the dashboard views or enhance NNM iSPI Performance for Metrics reports by sharing NNMi configuration settings, install the *optional* Network Performance Server (NPS) – [click here for more information](#).

An additional choice is available in the Actions menu that displays the NNM iSPI Performance for Metrics Report Menu. The context of the Report Menu changes depending on the currently selected object (Node, Node Group, Interface, or Interface Group). When selecting more than one object, multiple NNM iSPI Performance for Metrics reports open (one for each object, maximum 5).

No matter where you are in the NNMi console, the following option appears under the Actions menu:

Actions → **HPE NNM iSPI Performance** → **Reporting - Report Menu**

In a Path View, this additional option appears under the Actions menu:

Actions → **HPE NNM iSPI Performance** → **Reporting - Path Health**

NNMi administrators can force NNMi to synchronize the Interface and Node Group information between NNMi and NNM iSPI Performance for Metrics more quickly than the default time frame. This additional option also appears under the Actions menu:

Actions → HPE NNM iSPI Performance → Sync Interface and Node Groups

If you are an NNMi administrator, see [Creating Groups of Nodes or Interfaces](#) for more information.

You can launch Performance Troubleshooting to view graphs of metrics collected by the NNM iSPI Performance for Metrics. This option appears under the Actions menu after selecting a node or interface:

Actions → HPE NNM iSPI Performance → Performance Troubleshooting

See [Invoke Actions](#) for more information about how to access actions.

Chapter 13: Displaying Information About NNMi

Two menu items provide current information about your installed NNMi:

- **Help** → **System Information**

The System Information popup provides a wealth of current information about NNMi. The information available depends on your assigned NNMi role:

- NNMi Guest User:
- NNMi Level 1 Operator:
- NNMi Level 2 Operator:
- NNMi Administrator:

Within the System Information popup, click the  icon for access to the Help.

- **Help** → **About HPE Network Node Manager i Software**

System Information: Product Tab

To display the NNMi System Information, select **Help** → **System Information**. The System Information popup provides a wealth of current information about NNMi.

Note: The information available depends on your assigned NNMi role.

For information about each tab:

- NNMi Guest User:
- NNMi Level 1 Operator:
- NNMi Level 2 Operator:
- NNMi Administrator:

The Product tab: Displays information about NNMi.

- HPE Network Node Manager product name, version number, and date/time installed.
- Locale Information (language) for the current NNMi session:
 - Client Locale
 - Server Locale
 - SNMP String Encodings
 - Web Browser

- NNMi System Health shows the current status of NNMi health:
 - Status
 - Last Updated
- User Information about the current NNMi user:
 - User Name that you used when logging into NNMi.
 - **NNMi Role**¹ to which you are currently assigned.
 - User Groups to which you currently belong.
- The name of the NNMi product currently installed:
 - Network Node Manager i Community
 - Network Node Manager i
 - Network Node Manager i Advanced
 - Network Node Manager i Premium
 - Network Node Manager i Ultimate
- **Type** will be one of the following:

Instant-On	NNMi provides a 60-day 250 Node license automatically during installation.
Community	This means the free trial version of NNMi is installed.
Capacity	This means NNMi is installed.
Capacity(Adv)	This means NNMi Advanced is installed.
Premium	This means NNMi Premium is installed.
Ultimate	This means NNMi Ultimate is installed.

System Information: Health Tab

To display the NNMi System Information, select **Help** → **System Information**. The System Information popup provides a wealth of current information about NNMi.

Note: The information available depends on your assigned NNMi role.

For information about each tab:

¹Determined by your membership in one of four special NNMi User Groups (NNMi Administrators, NNMi Level 2 Operators, NNMi Level 1 Operators, or NNMi Guest Users). This membership determines what you can see and do within the NNMi console.

- NNMI Guest User:
- NNMI Level 1 Operator:
- NNMI Level 2 Operator:
- NNMI Administrator:

Health tab: Displays information about the current health of the NNMI server.

Displays summary level information regarding NNMI health, including NNMI's overall status as well as information and any issues related to the following:

- Memory
- The NNMI database
- System resources
- Disk usage
- SNMP requests and queues
- Global Network Management (*NNMI Advanced*)

Note: NNMI administrators can view more details by clicking the View Detailed Health Report button on the Health tab.

NNMI uses Status values to communicate about NNMI's overall health Status.

NNMI Overall Health Status

Status	Description
Normal	Indicates that NNMI is not experiencing any problems.
Warning	Indicates performance issues that are not significantly affecting NNMI.
Minor	Indicates problems that might result in out of date data. For example, an NNMI component, such as State Poller might be out of synch because it is operating outside of expected ranges.
Major	Indicates problems that are significantly affecting the NNMI management server's operations, but are not yet critical. Major Status usually indicates that some action is required. For example, a trap threshold is reached.
Critical	Indicates NNMI is not functioning. For example, NNMI is out of memory, all database connections are lost, or a major NNMI component has failed.

System Information: Server Tab

To display the NNMI System Information, select **Help** → **System Information**. The System Information popup provides a wealth of current information about NNMI.

Note: The information available depends on your assigned NNMI role.

For information about each tab:

- NNMi Guest User:
- NNMi Level 1 Operator:
- NNMi Level 2 Operator:
- NNMi Administrator:

Server tab: Displays information about the NNMi management server:

- Hostname
- IP Address
- IPv6 Address (*NNMi Advanced*)

Tip: (*NNMi Advanced*) If this is set to Disabled, consider the following:

- Are you using NNMi Advanced (required for IPv6 support)?
- Did your NNMi Administrator disable NNMi Advanced's IPv6 feature? See the "Configuring NNMi Advanced for IPv6" chapter in the *HPE Network Node Manager i Software Deployment Reference*, which is available at: <http://softwaresupport.hpe.com>.

- IPv6 Management (*NNMi Advanced*)
- IPv6 Communication (*NNMi Advanced*)
- Official Fully Qualified Domain Name (FQDN)
- User Account and User Group information obtained from (either the NNMi database or Directory Service using LDAP)
- Single Sign-On (configuration file name and whether the feature is enabled)
- Operating System
- Install Directory
- Data Directory
- Available Processors
- NNMi's Free / Allocated Memory (% Free)
- NNMi's Maximum Attemptable Memory

Note: (*NNMi Advanced*) When using the Global Network Management feature, this tab displays information about two NNMi servers:

- If your NNMi management server is a Global Manager, the displayed information's heading is **Global Management Server**.
- If your NNMi management server is a Regional Manager, the displayed information's heading on this tab is **Management Server**.

System Information: Global Network Management Tab

Global Network Management tab: (*NNMI Advanced*) Lists relevant information when the Global Network Management feature is enabled.

- If your NNMI management server is a Global Manager, the displayed information's heading is **Regional Managers Reporting to this Global Manager**.
- If your NNMI management server is a Regional Manager, the displayed information's heading on this tab is **Reporting to Global Managers**.

For each management server listed, the following information is provided:

- Name
- Connection State
- Node Count

System Information: Database Tab

To display the NNMI System Information, select **Help** → **System Information**. The System Information popup provides a wealth of current information about NNMI.

Note: The information available depends on your assigned NNMI role.

For information about each tab:

- NNMI Guest User:
- NNMI Level 1 Operator:
- NNMI Level 2 Operator:
- NNMI Administrator:

Database tab: Lists the number of each type of object stored in the NNMI database.

Possible objects include:

- Nodes
- SNMP Agents
- Interfaces
- IP Addresses
- Layer 2 Connections
- Incidents
- IP Subnets
- VLANs
- Node Sensors
- Chassis
- Cards

- Physical Sensors
- Ports
- Card Redundancy Groups
- Router Redundancy Groups (*NNMi Advanced*)

System Information: State Poller Tab

To display the NNMi System Information, select **Help** → **System Information**. The System Information popup provides a wealth of current information about NNMi.

Note: The information available depends on your assigned NNMi role.

For information about each tab:

- NNMi Guest User:
- NNMi Level 1 Operator:
- NNMi Level 2 Operator:
- NNMi Administrator:

State Poller tab: Lists statistics about the NNMi State Poller's current health:

- Status
- Collections requested
- Collections completed
- Collections in progress
- error instances for skips, stale collections, or exceptions
- Queue lengths

Extensions

This section displays information about the health of State Poller interactions with other NNM iSPI programs installed in your environment.

Monitored Objects

This section displays the details about which network objects are currently being monitored by NNMi; such as the number of object type and the current monitoring rates.

Nodes

This sections displays the number of nodes currently reporting faults, the total number of nodes being polled by each NNM iSPI and by NNMi.

System Information: Custom Poller Tab

To display the NNMi System Information, select **Help** → **System Information**. The System Information popup provides a wealth of current information about NNMi.

Note: The information available depends on your assigned NNMi role.

For information about each tab:

- NNMi Guest User:
- NNMi Level 1 Operator:
- NNMi Level 2 Operator:
- NNMi Administrator:

Custom Poller tab: Lists statistics about the NNMi Custom Poller's current health.

- Status
- Discoveries requested
- Nodes waiting for discovery
- Node discoveries in process
- SNMP response queue size
- Discoveries completed
- Stale nodes in last 5 minutes
- Stale node total

Extensions

This section displays information about the health of Custom Poller interactions with other NNM iSPI programs installed in your environment.

Monitored Objects

This section displays the details about which network objects are currently being monitored by NNMi; such as the number of object type and the current monitoring rates.

System Information: Causal Engine Tab

To display the NNMi System Information, select **Help** → **System Information**. The System Information popup provides a wealth of current information about NNMi.

Note: The information available depends on your assigned NNMi role.

For information about each tab:

- NNMi Guest User:
- NNMi Level 1 Operator:
- NNMi Level 2 Operator:
- NNMi Administrator:

Causal Engine tab: Lists statistics about the NNMi Causal Engine's current health.

Tip: NNMi's Causal Engine collects the data for calculating each object's Status value. Using the State

information collected by the State Poller as well as this additional information, the Causal Engine calculates the Status of each Node, Interface, and SNMP agent.

State = This value is provided by the NNMi State Poller and is always up to date for each object.

Status = This value can run behind by the amount of time listed below for Delay Processing Input.

The following information is available on the Causal Engine tab:

- Delay Processing Input
- Failures pre-loading data for conditions
- Average time to pre-load data for condition batch
- Average time to process condition
- Resynchronizing all NNMi components in progress (true or false)

System Information: Extensions Tab

To display the NNMi System Information, select **Help** → **System Information**. The System Information popup provides a wealth of current information about NNMi.

Note: The information available depends on your assigned NNMi role.

For information about each tab:

- NNMi Guest User:
- NNMi Level 1 Operator:
- NNMi Level 2 Operator:
- NNMi Administrator:

Extensions tab: Lists the NNMi Extensions deployed on your NNMi management server ([click here for more information](#)):

- **Product Extension Information**

NNMi is configured to allow communication with the items in this list:

Network Performance Server (NPS): provided by the *HPE Network Node Manager iSPI Performance for Metrics Software* (Enabled or Disabled)

Diagnostic Server: provided by the *HPE Network Node Manager iSPI Network Engineering Toolset Software*

- **HPE NNM iSPI Software Deployed**

This section displays a list of currently installed HPE Network Node Manager i Software Smart Plug-ins (iSPIs). In the far right column, NNMi displays the hostname of the server on which the NNM iSPI software and device extensions are installed.

- **Other.**

Other extensions that enhance NNMi functionality (independent of any NNM iSPI).

System Information: Integrations Tab

To display the NNMi System Information, select **Help** → **System Information**. The System Information popup provides a wealth of current information about NNMi.

Note: The information available depends on your assigned NNMi role.

For information about each tab:

- NNMi Guest User:
- NNMi Level 1 Operator:
- NNMi Level 2 Operator:
- NNMi Administrator:

Integrations tab: A table listing the other software products deployed on your NNMi management server that integrate with NNMi. This table includes the following columns of information:

- Name of the integration
- Identifier text string
- Version number
- A link that displays the actual configuration file currently in use for the selected integration.

System Information: Devices Tab

To display the NNMi System Information, select **Help** → **System Information**. The System Information popup provides a wealth of current information about NNMi.

Note: The information available depends on your assigned NNMi role.

For information about each tab:

- NNMi Guest User:
- NNMi Level 1 Operator:
- NNMi Level 2 Operator:
- NNMi Administrator:

Devices tab: A table listing the currently available Device Extension Information. This table includes the following columns of information:

- Name of the device extension
- Identifier text string
- Version number
- A link that displays the actual configuration file currently in use for the selected device extension.

System Information: Component Versions Tab

To display the NNMi System Information, select **Help** → **System Information**. The System Information popup provides a wealth of current information about NNMi.

Note: The information available depends on your assigned NNMi role.

For information about each tab:

- NNMi Guest User:
- NNMi Level 1 Operator:
- NNMi Level 2 Operator:
- NNMi Administrator:

Component Versions tab: Lists each NNMi component in your NNMi software by name and version number. Each component is a subset of the code that comprises the NNMi software.

Chapter 14: Displaying NNMi Version and License Information

Select **Help** → **About HPE Network Node Manager i Software** to display the following information:

- The name of the NNMi product currently installed:
 - Network Node Manager i
- The current version number of NNMi.
- **Type** will be one of the following:

Instant-On	NNMi provides a 60-day 250 Node license automatically during installation.
Community	This means the free trial version of NNMi is installed.
Capacity	This means NNMi is installed.
Capacity(Adv)	This means NNMi Advanced is installed.
Premium	This means NNMi Premium is installed.
Ultimate	This means NNMi Ultimate is installed.

Tip: See also **Help** → **System Information**, and navigate to the "[System Information: Product Tab](#)" on [page 178](#) and "[System Information: Extensions Tab](#)" on [page 185](#).

Glossary

A

AES

Advanced Encryption Standard

Anycast Rendezvous Point IP Address

Rendezvous Point addresses are loopback addresses used for routers in multi-cast network configurations.

Autonomous System

An Autonomous System (AS) is a collection of connected Internet Protocol (IP) routing prefixes that present a common, clearly defined Border Gateway Protocol (BGP) routing policy to the Internet by having an officially registered Autonomous System Number (ASN).

B

BGP

Border Gateway Protocol

C

Causal Engine

The NNMi Causal Engine analyzes the health of your network and provides the ongoing health status reading for each device. The Causal Engine also extensively evaluates problems and determines the root cause for you, whenever possible, sending incidents to notify you of problems. Any incident generated from a Causal Engine management event has an Origin of NNMi in your incident views.

CBC

Cipher Block Chaining

CE

Customer Edge router. The router in your network that sends data to an Internet Service Provider's router (the Provider Edge) on the path to the data's final destination.

CRC

Cyclic Redundancy Check

Custom Node Collection

A Custom Node Collection identifies a topology node that has at least one associated Custom Poller Policy. Because a topology node can be associated with more than one Policy, the same topology node might appear in multiple Custom Node Collections.

Custom Polled Instance

A Custom Polled Instance represents the results of a MIB variable when it is evaluated against a node. The first time a MIB variable is validated with discovery information, the results appear in the Monitoring workspace's Custom Polled Instances view. The Custom Polled Instance is updated whenever a change in State occurs and includes the most recent polled value that caused the State to change. These results are then used to determine the Status of the associated Custom Node Collection.

Custom User Groups

Custom User Groups are the User Groups that you create. These User Groups are additional to the NNMi User Groups, which are those User Groups that NNMi provides.

D

DES

Data Encryption Standard

E

EIGRP

Enhanced Interior Gateway Routing Protocol

EVPN

Ethernet Virtual Private Network.

G

global unicast address

(2000:: to 3fff:ffff:ffff:ffff:ffff:ffff:ffff:ffff) A publically routable IPv6 unicast address, used for communication between nodes anywhere on the internet. The first part of the address is a global routing prefix in the 2000::/3 address space for your organization (assigned by the Internet Service Providers). The complete host address can either be manually configured or automatically assigned using IPv6 auto-configuration and neighbor discovery.

H

HMAC

Hash-based Message Authentication Code

hops

A hop is a node representing any network device, such as a workstation, gateway, or switch, which is connected by a link with no intermediate nodes.

HSRP

Hot Standby Router Protocol

hypervisor

The virtual machine manager in charge of delegating various aspects from a pool of resources to become virtual devices. The delegations might be static or dynamic, depending on the manufacture's implementation. The type of virtual machines

being generated depends on the manufacturer's implementation.

I

IPv6 link-local address

A non-routable IPv6 unicast address only used for communication with other nodes on the same link (LAN or VLAN). Link local addresses cannot be used for communication that must be forwarded through a router. IPv6 auto-configuration automatically assigns a unique link local address in the fe80::/10 address space to each IPv6-enabled interface on a system.

ISIS

Intermediate System to Intermediate System Protocol

J

Jython

Jython is a programming language (successor of JPython) uses Java class, instead of Python modules.

K

Key Incident

Incidents with both: (1) Severity = other than Normal. (2) Correlation Nature = equal to Root Cause, Service Impact, Stream Correlation, Rate Stream Correlation, Info, or None.

L

Layer 2

Refers to the Data Link layer of the multilayered communication model, Open Systems Interconnection (OSI). The Data Link layer moves data across the physical

links in the network. The switches and switch-routers are devices that redirect data messages at the layer 2 level, using the destination Media Access Control (MAC) address to determine where to direct the message.

Layer 3

Refers to the Network layer of the multilayered communication model, Open Systems Interconnection (OSI). The Network layer is concerned with knowing the address of the neighboring nodes in the network, selecting routes and quality of service, and recognizing and forwarding incoming messages to local host domains. The router and switch-router are the devices that redirect data messages at the Layer 3 level. Everything in a subnet is connected at the Layer 3 (IP) level.

Link Aggregation

Protocols used on Switches to configure multiple Interfaces (Aggregation Member Interfaces) to function as if they were one (an Aggregator Interface). When two Aggregator Interfaces establish a connection, that connection is an Aggregator Layer 2 Connection. The Aggregator Layer 2 Connection appears on Layer 2 Neighbor View maps as a thick line with an Interface icon at each end (representing the Aggregator Interface).

loopback address

The address associated with the loopback interface. The loopback interface is a virtual interface on a device that provides a route for internal communication. Many vendors provide a specially configured loopback for management purposes. Exact details of how loopbacks are configured varies by vendor and model. See each device's documentation for details. NNMi identifies these loopback addresses by using ifType Number 24, softwareloopback from the IANA ifType-MIB.

M

MAC address

The Media Access Control address (hardware address or physical address) that the factory burns into a network adapter or device with built-in networking capability. A MAC address has six pairs of hexadecimal digits, separated by colons or dashes. For example 02:1F:33:16:BC:55

MAC addresses

The Media Access Control address (hardware address or physical address) that the factory burns into a network adapter or device with built-in networking capability. A MAC address has six pairs of hexadecimal digits, separated by colons or dashes. For example 02:1F:33:16:BC:55

MD5

Message-Digest algorithm 5

MIB file

Management Information Base files are the basic building block of SNMP communication protocol. SNMP Agents are configured to respond to requests defined by a group of supported MIB files.

MPLS

Multiprotocol Label Switching

multicast address

Used to identify a group of hosts joined into a group. IPv4 multicast addresses are in the range 224.0.0.0 to 239.255.255.255 and IPv6 multicast addresses have the prefix ff00::/8.

multiconnection

A multiconnection is a thick line on a map view between two Node icons, two Node Group icons, or between a Node icon and a Node Group icon (with no Interface icon or IP Address icon at either end of the line). This

thick line represents a set of multiple connections that have been combined to preserve space and simplify the map. Your NNMi administrator specifies the number of connections that must exist before NNMi condenses them into a multiconnection line (User Interface Configuration's Multiconnection Threshold attribute). Double-click the thick line to convert it into the original set of connections with Interface icons or IP Address icons at either end of the lines.

N

NAT

Network Address Translation. NNMi supports the following protocols: Static Network Address Translation, Dynamic Network Address Translation, Dynamic Port Address Translation.

NIC

Network Interface Controller

NNMi Role

Determined by your membership in one of four special NNMi User Groups (NNMi Administrators, NNMi Level 2 Operators, NNMi Level 1 Operators, or NNMi Guest Users). This membership determines what you can see and do within the NNMi console.

NNMi User Group

NNMi User Groups are those User Groups provided by NNMi. Users cannot access the NNMi console until their User Account is mapped to at least one of the following NNMi User Groups: NNMi Administrators, NNMi Level 2 Operators, NNMi Level 1 Operators (with more limited access privileges than Level 2 Operators), and NNMi Guest Users

Node

A physical or virtual collection of network interfaces that NNMi can pragmatically

associate together.

O

OSPF

Open Shortest Path First Protocol

P

PE

Provider Edge router. The Internet Service Provider's router that receives your data on the path to your data's final destination. The Customer Edge (CE) router in your network connects to this PE.

private IP addresses

These are IPv4 addresses that can be reused in home and office local area networks (LANs). Following the standards set by RFC 1918 and RFC 4193 (10.*.*.*, 169.254.*.*, 172.16-31.*.*, and 192.168.*.*)

R

RAMS

HP Router Analytics Management System

routing prefixes

A network protocol technique used to shorten or filter the amount of required routing information in each packet by declaring a prefix for an entire group of packets. This prefix also indicated the number of bits in the address.

S

SHA

Secure Hash Algorithm

SNMP

Simple Network Management Protocol

SNMP Agent

Simple Network Management Protocol (SNMP) is an Internet-standard protocol used to manage devices on IP networks. The SNMP Agent uses this protocol to report information to authorized management programs.

SOAP

Simple Object Access Protocol

Split Link Aggregation

Link Aggregation with more than two endpoints. Some vendors refer to this as Multi-Chassis Link Aggregation, SLAG, MLAG, or MC-LAG.

U

unique local address

(fd00:: to fdff:ffff:ffff:ffff:ffff:ffff:ffff:ffff) A privately routable IPv6 unicast address used only for communication between nodes within your organization. The unique local addresses cannot be routed to the public internet. The address consists of a routing prefix in the fd00:/8 address spaces, assigned locally by your organization. And the full host address might be manually configured or automatically assigned using IPv6 auto-configuration and neighbor discovery.

Unmanaged

Indicates the Management Mode is "Not Managed" or "Out of Service".

USM

User-based Security Model

UUID

Universally Unique Object Identifier, which is unique across all databases.

V

virtual machine

A device that utilizes components from multiple physical devices. Depending on the manufacture's implementation, the virtual machine may be static or dynamic.

VMware

VMware ESX and VMware ESXi software uses SOAP protocol to implement bare-metal hypervisors.

VRRP

Virtual Router Redundancy Protocol

W

WAN Cloud

Layer 3 connectivity between your network and any MPLS networks.

Web Agent

The Web Agent represents a management service running on a device and contains the settings NNMi uses to communicate with the device.

Send Documentation Feedback

If you have comments about this document, you can [contact the documentation team](#) by email. If an email client is configured on this system, click the link above and an email window opens with the following information in the subject line:

Feedback on Online Help: Using the Console (Network Node Manager i Software 10.20)

Just add your feedback to the email and click send.

If no email client is available, copy the information above to a new message in a web mail client, and send your feedback to network-management-doc-feedback@hpe.com.

We appreciate your feedback!