



# HP Universal CMDB

Software Version: 10.21

## Modeling Guide

Document Release Date: July 2015  
Software Release Date: July 2015

## Legal Notices

### Warranty

The only warranties for HP products and services are set forth in the express warranty statements accompanying such products and services. Nothing herein should be construed as constituting an additional warranty. HP shall not be liable for technical or editorial errors or omissions contained herein.

The information contained herein is subject to change without notice.

### Restricted Rights Legend

Confidential computer software. Valid license from HP required for possession, use or copying. Consistent with FAR 12.211 and 12.212, Commercial Computer Software, Computer Software Documentation, and Technical Data for Commercial Items are licensed to the U.S. Government under vendor's standard commercial license.

### Copyright Notice

© 2002 - 2015 Hewlett-Packard Development Company, L.P.

### Trademark Notices

Adobe™ is a trademark of Adobe Systems Incorporated.

Microsoft® and Windows® are U.S. registered trademarks of Microsoft Corporation.

UNIX® is a registered trademark of The Open Group.

## Documentation Updates

The title page of this document contains the following identifying information:

- Software Version number, which indicates the software version.
- Document Release Date, which changes each time the document is updated.
- Software Release Date, which indicates the release date of this version of the software.

To check for recent updates or to verify that you are using the most recent edition of a document, go to: <https://softwaresupport.hp.com/>.

This site requires that you register for an HP Passport and to sign in. To register for an HP Passport ID, click **Register** on the HP Support site or click **Create an Account** on the HP Passport login page.

You will also receive updated or new editions if you subscribe to the appropriate product support service. Contact your HP sales representative for details.

## Support

Visit the HP Software Support site at: <https://softwaresupport.hp.com>.

This website provides contact information and details about the products, services, and support that HP Software offers.

HP Software online support provides customer self-solve capabilities. It provides a fast and efficient way to access interactive technical support tools needed to manage your business. As a valued support customer, you can benefit by using the support website to:

- Search for knowledge documents of interest
- Submit and track support cases and enhancement requests
- Download software patches
- Manage support contracts
- Look up HP support contacts
- Review information about available services
- Enter into discussions with other software customers
- Research and register for software training

Most of the support areas require that you register as an HP Passport user and to sign in. Many also require a support contract. To register for an HP Passport ID, click **Register** on the HP Support site or click **Create an Account** on the HP Passport login page.

To find more information about access levels, go to: <https://softwaresupport.hp.com/web/softwaresupport/access-levels>.

**HP Software Solutions Now** accesses the HPSW Solution and Integration Portal website. This site enables you to explore HP Product Solutions to meet your business needs, includes a full list of Integrations between HP Products, as well as a listing of ITIL Processes. The URL for this website is <http://h20230.www2.hp.com/sc/solutions/index.jsp>.

# Contents

<b>Introduction to HP Universal CMDB</b> .....	<b>13</b>
<b>Chapter 1: Topology Query Language</b> .....	<b>14</b>
Topology Query Language (TQL) Overview .....	14
Creating TQL Queries in the UCMDB Managers .....	16
Viewing TQL Query Results .....	16
Compound Relationship .....	18
Join Relationship .....	18
Query Node Conditions .....	19
Complex Type Condition .....	21
Subgraph Definition .....	22
The Use Update Value Policy Qualifier .....	23
How to Define a TQL Query .....	24
How to Add Query Nodes and Relationships to a TQL Query .....	26
How to Define a Compound Relationship – Scenario .....	27
How to Define a Join Relationship – Scenario .....	30
How to Define an Attribute Condition – Scenario .....	31
How to Define a Complex Type Condition - Scenario .....	32
How to Create a Subgraph Definition – Scenario .....	33
Shortcut Menu Options .....	34
Attribute Operator Definitions .....	40
TQL Logs .....	42
Topology Query Language User Interface .....	45
Add/Edit Calculated Relationship Dialog Box .....	46
Add/Edit Compound Relationship Dialog Box .....	48
Add/Edit Join Relationship Dialog Box .....	51
Add/Edit Relationship Dialog Box .....	54
Add Related Query Node Wizard .....	56
Related Query Node Type Page .....	57
Relationship Type Page .....	59
Related Query Node Properties Page .....	60
Related Query Node Instances Page .....	62
Add Triplet Dialog Box .....	63

CI Instances Dialog Box .....	66
Conditions Preview Dialog Box .....	69
Element Layout Preview Dialog Box .....	69
Filter CI Instances Dialog Box .....	70
Join Relationship Condition Dialog Box .....	71
Layout Settings Dialog Box .....	72
Query Node/Relationship Properties Dialog Box .....	73
Refine Query Node Type Dialog Box .....	87
Select Relationship Type Dialog Box .....	88
Subgraph Condition Definition Dialog Box .....	89
Subgraph Definition Dialog Box .....	91
User Preferences Dialog Box .....	93
Troubleshooting and Limitations – Topology Query Language .....	94
<b>Chapter 2: Using Calculated Relationships .....</b>	<b>99</b>
Calculated Relationships Overview .....	99
Calculated Relationships .....	99
Calculated Relationship Types .....	100
How to Set Folding Rules for Composite CIs .....	100
<b>Chapter 3: Create a URL for a Direct Link .....</b>	<b>104</b>
Generate a Direct Link – Overview .....	104
How to Generate a Direct Link – Scenario .....	105
How to Create a Direct Link to a Template with Parameter Values .....	105
How to Encrypt the Password of a Direct Link Using the JMX Console .....	106
Generate a Direct Link User Interface .....	107
Generate Direct Link Dialog Box .....	107
Generate Direct Link Wizard .....	108
Select Command Page .....	108
Direct Link Parameters – CI Selector Page .....	111
Direct Link Parameters – CI Type Selector Page .....	112
Direct Link Parameters – CII Grid Page .....	113
Direct Link Parameters – Impact Map Page .....	114
Direct Link Parameters – Model Editor .....	115
Direct Link Parameters – Query Editor .....	116
Direct Link Parameters – Related CIs Page .....	116
Direct Link Parameters – Report Viewer Page .....	117
Direct Link Parameters – Report Viewer – Saved Report Page .....	117

Direct Link Parameters – Show CI Properties Page .....	118
Direct Link Parameters – Show View Topology Page .....	119
Direct Link Parameters – View Editor Page .....	119
Direct Link Parameters – Views Selector Page .....	120
Direct Link Parameters – Show View Page .....	120
Direct Link Parameters – Start in Mode Page .....	121
Finish Page .....	122
Chapter 4: Embedding UCMDB Applets Using Direct Links .....	123
Using the Direct Link Functionality to Embed UCMDB Applets .....	123
UCMDB Applet Tag Overview .....	124
Direct Link Operation Flow .....	125
Chapter 5: Working with the CI Selector .....	130
CI Selector Overview .....	130
How to Display a View in Browse Mode .....	130
How to Search for CIs in Search Mode .....	131
How to Modify CI Selector Display Options .....	132
CI Selector User Interface .....	133
CI Conditional Search Dialog Box .....	134
CI Selector .....	135
Organize Searches Dialog Box .....	144
Running Software Search Dialog Box .....	145
Save Search Criteria Dialog Box .....	146
Troubleshooting and Limitations – CI Selector .....	146
Chapter 6: Working with the Topology Map .....	148
Topology Map Overview .....	148
Handling Large Views .....	149
Topology Map User Interface .....	149
Export Map to Image Dialog Box .....	150
Layout Properties Dialog Box .....	150
Main Menu .....	164
Print Dialog Box .....	165
Print Preview Dialog Box .....	166
Print Setup Dialog Box .....	166
Toolbar Options .....	168
Topology Map Sidebar .....	176

Automated Service Modeling .....	179
<b>Modeling .....</b>	<b>180</b>
Chapter 7: IT Universe Manager .....	181
IT Universe Manager Overview .....	181
Working with Views in IT Universe Manager .....	182
View Tree Structure .....	184
Working with CIs .....	185
Working with Relationships .....	188
How to Create CIs and Relationships .....	194
How to View Related CIs .....	194
How to Check the Status of Application Discovery (Rediscover a View) .....	196
How to Check the Network Availability of an Inventory CI .....	198
How to View Discovery Status and Errors for a Selected CI .....	201
How to Retrieve Impact Analysis Results – Scenario .....	207
How to Take a Snapshot of a View .....	213
How to Print and Save a Topology Map to File .....	213
IT Universe Manager User Interface .....	213
Add CIs to Model Dialog Box .....	214
Add CIs to View Dialog Box .....	215
Change Timeframe Dialog Box .....	215
Check Network Availability Dialog Box .....	216
CI/Relationship History Dialog Box .....	218
Configuration Item Properties Dialog Box .....	220
Generate Sub Report Dialog Box .....	225
Get Related CIs From CMDB Dialog Box .....	226
Insert Relationship Dialog Box .....	226
Relationship Page .....	227
IT Universe Manager Page .....	230
New CI/New Related CI Dialog Box .....	242
Relationship Dialog Box .....	244
Recently Discovered By Dialog Box .....	247
Run Impact Analysis Dialog Box .....	247
Save Snapshot Dialog Box .....	249
Show Discovery Status and Changes Dialog Box .....	250
Show Impact Pane .....	251

Chapter 8: Modeling Studio .....	254
Modeling Studio Overview .....	254
View Formats .....	255
Building a Business View .....	255
Templates and Perspectives .....	259
Predefined Folders and Views .....	260
Creating Template Based Views .....	261
Business CI Models .....	262
Building a Perspective-based View .....	264
Revealed CIs and Watchpoints .....	267
How to Create a Pattern View .....	271
How to Create a Template .....	273
How to Create a Perspective .....	274
How to Create a Dynamic Widget .....	276
How to Create a Template Based View .....	278
How to Create Multiple Template Based Views .....	280
How to Define Report Settings .....	281
How to Build an Instance-based Model .....	283
How to Build a New Pattern-based Model .....	284
How to Build a Perspective-based View Based on a Model .....	285
How to Build a Perspective-based View Based on a Collection of CIs .....	286
Modeling Studio User Interface .....	287
Add/Edit Function Dialog Box .....	288
Change Query Node/Relationship Type Dialog Box .....	290
Choose Operation for Selected Items Dialog Box .....	291
Conditions of Related CIs Dialog Box .....	292
Create/Edit/Save Reveal Path Dialog Box .....	293
Creating New View Dialog Box .....	294
Cycle Definition Dialog Box .....	295
Hidden CIs Dialog Box .....	296
Hierarchy Rules Dialog Box .....	296
Left Pane .....	297
Manage CI Watchpoints Dialog Box .....	303
Model Editor .....	304
Modeling Studio Page .....	311
Models Containing Selected CI Dialog Box .....	313

New Model Dialog Box .....	314
New Pattern View/Template/Perspective Dialog Box .....	315
New Watchpoint Dialog Box .....	316
Open Reveal Path Dialog Box .....	317
Pattern Based Model Scheduler Dialog Box .....	318
Pattern Based Model Wizard .....	319
Select CI Type Page .....	320
Query Selection Page .....	320
Pattern View Editor .....	321
Perspective-based View Editor .....	328
Query Node Grouping Dialog Box .....	334
Query/View Definition Properties Dialog Box .....	335
Reveal CIs Dialog Box .....	337
Save Query Dialog Box .....	339
Save View/Template/Perspective Dialog Box .....	340
Select Integration Points Dialog Box .....	341
Sort Column Content Dialog Box .....	342
Template-based View Wizard .....	343
Select Template Page .....	343
Import Parameter Values Page .....	344
Enter Parameters Page .....	345
Select Location for Views Page .....	346
Summary Page .....	347
Save Views Page .....	347
Template Parameter Values Dialog Box .....	348
TQL Query Editor .....	348
Views Containing Selected CI Dialog Box .....	353
Watchpoints Updates Dialog Box .....	354
<Query/Template/Perspective Name> Dependencies Dialog Box .....	355
Chapter 9: Reports .....	356
Topology Reports Overview .....	356
Custom Reports Overview .....	357
How to View a Topology Report .....	357
How to Generate a Custom Report .....	358
How to Compare CIs .....	359
How to Compare Snapshots .....	360



How to Enable Hyperlinks and Display Icons .....	362
Cron Expressions .....	362
Reports User Interface .....	363
Agent Status Report .....	365
Application Breakdown Report .....	367
Application License Report .....	369
Asset Report .....	371
Auditing Report .....	372
Changed Application Report .....	377
Changed Views Report .....	379
CI Change Report .....	380
CMDB Utilization Report .....	385
Compare Archives Report .....	386
Compare CIs Report .....	390
Compare Snapshots Report .....	395
Configuration Manager Policy Report .....	399
Database Breakdown Report .....	401
Delete Candidates Report .....	404
Dependency Report .....	405
Discovery Errors Report .....	407
Generic Breakdown Report .....	409
Gold Master Report .....	411
Hardware Component Summary Report .....	414
Impact Analysis Report .....	415
Job List Dialog Box .....	417
Licensed OSIs Report .....	419
Migration Progress Report .....	422
Network Device Breakdown Report .....	422
Node OS Breakdown Report .....	425
Node Summary Report .....	427
Node Summary by VLAN Report .....	429
Number of Changes Report .....	431
Recognized Applications Report .....	433
Report Properties Dialog Box .....	434
Reports Page .....	435
Rulebase Support Report .....	440

Scan File Status Report .....	441
Scanner Execution Details Report .....	442
Schedule Report/Snapshot Dialog Box .....	444
Service Discovery Errors Report .....	448
Software Utilization Report .....	450
Solaris Zone Report .....	452
Topology Report .....	453
View Change Report .....	454
VMware Host Report .....	456
VMware Virtual Center Report .....	457
Zone-Based Discovery Errors Report .....	458
Report Toolbar Options .....	460
Reports on Non-English Locales – Notes and Limitations .....	464
Chapter 10: Impact Analysis Manager .....	466
Impact Analysis Manager Overview .....	466
How to Define an Impact Rule – Workflow .....	467
Impact Analysis Manager User Interface .....	470
Details Dialog Box .....	470
Impact Analysis Manager Page .....	470
Impacted Query Nodes Dialog Box .....	478
Impact Rules Definition Dialog Box .....	479
New Impact Rule/Impact Rule Properties/Save As Impact Rule Wizard .....	480
Impact Rule General Attributes Page .....	481
Impact Rule Base Query Page .....	482
Impact Rule Groups Page .....	483
Chapter 11: CI Type Manager .....	485
CI Types Overview .....	485
CI Type Attributes .....	486
CI Type Relationships .....	488
Deprecated CI Types .....	488
System Type Manager .....	489
How to Create a CI Type .....	490
How to Create a Relationship Type .....	492
How to Create a Calculated Relationship Type .....	493
How to Create List and Enumeration Definitions .....	494
How to Create an Enumeration Definition – Workflow .....	494

View Descriptions for CI Types and Relationships .....	496
CI Type Manager User Interface .....	497
Add/Edit Attribute Dialog Box .....	497
Add/Remove Relationship Dialog Box .....	501
CI Type Manager Page .....	502
Create Configuration Item Type/Relationship/Calculated Relationship Wizard .....	506
Details Page .....	507
Attributes Page .....	508
Qualifiers Page .....	512
Triplets Page .....	514
Icon Page .....	515
Attached Menu Page .....	516
Default Label Page .....	519
Matching Rules Page .....	521
Create/Update List/Enumeration Definition Dialog Box .....	522
Export Selected CITs to Excel Dialog Box .....	525
Export Selected CITs to PDF Dialog Box .....	526
System Type Manager Dialog Box .....	527
Chapter 12: Enrichment Manager .....	529
Enrichment Manager Overview .....	529
How to Define an Enrichment Rule – Scenario .....	531
How to Add Enrichment Query Nodes and Relationships to an Enrichment TQL Query .....	536
How to Define a Tenant Association Rule .....	537
Enrichment Manager User Interface .....	539
Enrichment Manager Page .....	539
New Enrichment Rule/Enrichment Rule Properties/Save As Enrichment Rule Wizard ...	547
Rule General Attributes Page .....	548
Rule Base Query Page .....	550
New Tenant Association Rule/Tenant Association Rule Properties/Save As Tenant Association Rule Wizard .....	551
Rule General Attributes Page .....	552
Rule Base Query Page .....	553
Query Node/Relationship Definition Dialog Box .....	555
Query Node Definition – Advanced Attribute Dialog Box .....	557
Update Consumer Tenants Dialog Box .....	559
Update Owner Tenant Dialog Box .....	560

<b>HP Universal CMDB Data Model .....</b>	<b>562</b>
Chapter 13: UCMDB Data Model Introduction .....	563
Universal Data Model (UDM) Overview .....	563
Chapter 14: Exporting the UCMDB Data Model to a UML Tool .....	564
Export to UML Tool – Overview .....	564
How to Export the Class Model .....	564
How to Convert XML of a Selected Part of the Class Model .....	565
Export to UML Tool User Interface .....	566
Export Class Model to UML Wizard .....	566
Select Valid Links .....	567
Export Selected Items .....	568
Tool Plug-in Input .....	568
<b>Reference Information .....</b>	<b>570</b>
Chapter 15: Working with Tables .....	571
Columns User Interface .....	571
Select Columns Dialog Box .....	571
Sort Column Content Dialog Box .....	572
Chapter 16: Regular Expression Examples .....	574
Examples of Regular Expressions .....	574
<b>Send Documentation Feedback .....</b>	<b>575</b>

# Introduction to HP Universal CMDB

# Chapter 1: Topology Query Language

This chapter includes:

Topology Query Language (TQL) Overview .....	14
Creating TQL Queries in the UCMDB Managers .....	16
Viewing TQL Query Results .....	16
Compound Relationship .....	18
Join Relationship .....	18
Query Node Conditions .....	19
Complex Type Condition .....	21
Subgraph Definition .....	22
The Use Update Value Policy Qualifier .....	23
How to Define a TQL Query .....	24
How to Add Query Nodes and Relationships to a TQL Query .....	26
How to Define a Compound Relationship – Scenario .....	27
How to Define a Join Relationship – Scenario .....	30
How to Define an Attribute Condition – Scenario .....	31
How to Define a Complex Type Condition - Scenario .....	32
How to Create a Subgraph Definition – Scenario .....	33
Shortcut Menu Options .....	34
Attribute Operator Definitions .....	40
TQL Logs .....	42
Topology Query Language User Interface .....	45
Troubleshooting and Limitations – Topology Query Language .....	94

## Topology Query Language (TQL) Overview

Topology Query Language (TQL) is a language and tool for discovering, organizing, and managing IT infrastructure data. It enables you to create TQL queries that retrieve business service data from the

CMDB. TQL queries also help you display the data in a visual representation that facilitates data monitoring and managing.

This section includes the following topics:

- ["Topology Query Language" below](#)
- ["The Roles of TQL" below](#)

## Topology Query Language

TQL extends the standard SQL language by adding two important capabilities:

- TQL enables you to draw conceptual relationships between configuration items (CIs), which represent their actual interdependencies. Using predefined operators, the different types of interconnections (relationships) that exist between CIs can be established, and consequently the infrastructure design and performance are more accurately represented. This representation serves as a basis and a model for the discovery, arrangement, query, and management of complex infrastructures.
- TQL includes a graphical aspect, consisting of visual symbols and syntax, that represents the resources and their interconnections. This visualization of an IT infrastructure simplifies the understanding, monitoring, and managing of the IT business operations.

## The Roles of TQL

TQL plays several roles:

- Builds a business service model that defines and delineates the interconnection between IT assets that function together as business services. The business service model guides the discovery and identification of these business services, from the ever-increasing number and complexity of infrastructure resources. After the resources that comprise the business services are discovered, the business service model structures the way they are organized and managed in the CMDB.
- Constantly searches the CMDB for changes that occur in the state of managed resources. When such changes are detected, the relevant subsystems are informed and updated.
- Creates queries that retrieve business service data from the CMDB, and displays the data in a visual representation that facilitates data monitoring and managing.

## Creating TQL Queries in the UCMDB Managers

The following managers enable you to create TQL queries that retrieve specific data from the CMDB and to display that data:

- **Impact Analysis Manager.** An Impact rule simulates how infrastructure changes can impact your system and enables you to determine the true origin of a problem and its business impact. During rule creation, you define the base TQL query type, which can be a new query or an existing query. For details, see ["Impact Analysis Manager" on page 466](#).
- **Enrichment Manager.** An Enrichment rule enables enlarging the CMDB, deleting CI instances from the CMDB, or updating the attributes of a CI that already exists in the CMDB. During rule creation, you define the base TQL query type, which can be a new query or an existing query. For details, see ["Enrichment Manager" on page 529](#).
- **Modeling Studio.** You can build a new TQL query using the TQL Query Editor or you can build a new query while defining a new view, template, or perspective using the Pattern View Editor. You can also define the topology report settings for any view in the Pattern View Editor. For details, see ["Modeling Studio" on page 254](#).

## Viewing TQL Query Results

You view the resulting data in a visual representation in IT Universe Manager. The queries define the structure of the resulting topology map. The view displays only those CIs and relationships that meet the query definition. You can also view the results of a query by clicking the **Preview**  button on the toolbar to open a preview display identical to IT Universe Manager. For more details about IT Universe Manager, see ["IT Universe Manager" on page 181](#).

### TQL Query Types and Priorities

When you define a TQL query, you define the type of the TQL query in the Type field of the Query Definition Properties dialog box. The following query types are available:

- **View.** TQL queries used as the basis for pattern views.
- **Integration.** TQL queries used for integrations.



- **Discovery.** TQL queries used as the basis for DFM patterns.
- **Template.** TQL queries used as the basis for templates.
- **Perspective.** TQL queries used as the basis for perspectives.
- **Impact Analysis.** TQL queries used as the basis for Impact rules. This is the default type for queries created in Impact Analysis Manager.
- **Enrichment.** TQL queries used as the basis for Enrichment rules. This is the default type for queries created in Enrichment Manager.

You cannot change the type of an existing TQL query if it has dependencies (such as views, templates, and so on).

If a query imported through an integration is not assigned a type, it is considered a hidden query and does not appear in the query list in the Modeling Studio. To display hidden queries in the query list, change the setting for hidden queries under General in the User Preferences dialog box. For details, see ["User Preferences Dialog Box" on page 93](#).

You can also set the priority level of a TQL query, which determines how often the query is rerun automatically to include updated information. The following priorities are available:

- **Low.** The TQL query is refreshed every 2 minutes.
- **Medium.** The TQL query is refreshed every 30 seconds.
- **High.** The TQL query is refreshed every 10 seconds.
- **Express.** The TQL query is refreshed continuously.
- **Not Active.** The TQL query is inactive.

**Note:** The above refresh times are average values.

If you set the priority of a TQL query to **Not Active**, the query becomes inactive and is not run automatically; however, it can be used for manually building a view.

## Base Queries

You can select a base query for a TQL query in the Query Definition Properties dialog box. In this case, the base query is first applied to the entire IT Universe, generating results. The new query is then

applied to that subset of the universe, further refining the results. Selecting a base query enables you to filter the query results more finely and generate results more quickly in certain cases.

The base query you select must be both active and persistent for your new query to be active. If the base query is not active and persistent, the new query is automatically assigned a priority of **Not Active**.



### TQL Query Thread Pool

Each TQL query is calculated in a separate thread, taken from a thread pool. If there are many TQL queries being calculated, you can increase the thread pool size to improve performance. Edit the **TQL Threads Pool Size** setting in the Infrastructure Settings Manager. The pool size can be any integer value between 1 and 64. If no value is entered, the pool size is automatically set to be the number of CPU cores divided by the number of customers (if this number is smaller than 4, it is set to a minimum of 4 threads).

## Compound Relationship

A compound relationship represents a path in the topological graph. You use a compound relationship to define the allowed steps in the path between the source and the target CIs.

Each row represents one of the allowed steps in the path leading from the source CI to the target CI in the topology map.

Source	Relationship	Target
 IpSubnet	 Membership	 Node
 Node	 Containment	 IpAddress

For an example of a compound definition, see ["How to Define a Compound Relationship – Scenario" on page 27](#). For details on defining compound relationships, see ["Add/Edit Compound Relationship Dialog Box" on page 48](#).

## Join Relationship

A join relationship is a logical connection that represents the relationship between two CIs (and which appears only in the topology map containing the TQL query results). It does not exist in the CMDB. A join relationship is created by defining an attribute for each query node, whose values are used for comparison.

The TQL results retrieve all CIs whose attribute values meet the conditions defined in the join definition.

For example, you can create a join definition that links all **node** CIs connected to **IP Address** CIs whose **Created By** attribute values are equal (see the example below).

Node	Operator	IpAddress
Created By	Equal	Created By

Each join definition represents one condition defined for the join relationship.

**Note:** You can define multiple conditions.

For an example of a join definition, see ["How to Define a Join Relationship – Scenario" on page 30](#). For details on defining join relationships, see ["Add/Edit Join Relationship Dialog Box" on page 51](#).

## Query Node Conditions

You can add conditions to the query nodes and relationships of a TQL query in the Query Node Properties dialog box. The conditions filter the query results by retrieving only CIs and relationships that match the conditions defined in the query. There are several types of conditions you can define:

- **Attributes.** Conditions based on CI property values.
- **Cardinality.** Conditions based on the number of related query nodes.
- **Qualifiers.** Conditions based on CI type qualifiers.
- **Element type.** Conditions based on CI subtypes. See below for details.
- **Identity.** Conditions based on CI element IDs.

Each one has a separate tab in the dialog box. For details, see ["Query Node/Relationship Properties Dialog Box" on page 73](#).

When you define an attribute condition using the attribute name **CI Type**, the condition is converted to a complex type condition when you save the query. The condition disappears from the Attribute tab and appears in the Element Type tab. For Enrichment and Impact type queries, the condition disappears from the Attribute tab in Enrichment Manager or Impact Analysis Manager, and you need to open the query in Modeling Studio to edit it in the Element Type tab.

**Note:** If you define an attribute condition that is not supported for the selected data, the condition is ignored during the TQL query calculation.

## Element Type Conditions

The Element type conditions enable you to specify the subtypes of a query node that should appear in the query results. There are two options for defining this condition:

- **Simple Type Condition.** The simple type condition enables you to either include all subtypes of the selected query node in the query results, or to exclude all of them.
- **Complex Type Condition.** The complex type condition enables you to select the specific subtypes of the query node to be included in the query results. For details, see ["Complex Type Condition" on the next page.](#)

## Element Layout

You can specify the attributes to include in the query results for each query node or relationship in a TQL query in the Element Layout tab of the Query Node Properties dialog box. Select the **Select attributes for layout** radio button and then select a CIT or relationship in the CIT pane. If you select **Specific Attributes** for the Attributes condition, only the attributes you move to the Specific Attributes pane are included in the query results for that element. If you select **All** for the Attributes condition, all of the available attributes are included in the query results for that element. In this case, you can select **Exclude specific attributes** and move selected attributes to the Excluded Attributes pane.

There is also an option to select attributes by qualifiers. If you select qualifiers in the **Attributes with the following qualifiers** field, all attributes that have the selected qualifiers are included in the query results for that element, in addition to the attributes selected in the Specific Attributes pane. In this case too, you can exclude selected attributes by moving them to the Excluded Attributes pane.

By default, the attribute settings you select for a CIT are automatically applied to its descendant CITs in the query results; however, the settings are not visible in the Element Layout tab of the dialog box. For example, if you select specific attributes to be included for the **Database** CIT, the same attributes are included for the **Oracle** CIT (a child CIT of **Database**), but if you select **Oracle** in the CIT pane, the Attributes condition displayed is **None** (the default condition).

You can then make an attributes condition selection for the child CITs themselves. If the parent CIT has **All** selected as the attributes condition, then the **Specific Attributes** option is disabled for the child CITs. If the parent CIT has **Specific Attributes** selected as the attributes condition, you can select **All** or **Specific Attributes** for the child CIT. If you select **Specific Attributes**, you can add more attributes by moving them to the Specific Attributes pane. These are included in the query results along with the attributes inherited from the parent CIT's setting. Similarly, you can select attributes from the parent CIT's setting to exclude for the child CIT, by moving them to the Excluded Attributes pane. If the parent CIT has qualifiers selected to determine the attribute selection, these are also inherited by the child CIT.

If you select additional qualifiers to filter the child CIT's attribute selection, the combined set of selected qualifiers is used to filter the attribute selection for the child CIT.

When you change the type of a query node or relationship using the Change Query Node/Relationship Type dialog box, the attributes selection for that element is lost.

If you import a package with a query that includes an attributes selection that is invalid for the selected query node, or if you make an invalid attributes selection using the JMX console, the query can be saved successfully and a warning appears in the log.

**Note:** The layout selection is not visible in the query results in the user interface. To view the query results with the selected attributes, access the JMX console, select **TQL services**, and invoke the **calculateTqlAdHoc** method.

For details on the Element Layout tab, see "[Element Layout Tab](#)" on page 83.

## Complex Type Condition

The complex type condition enables you to select the specific subtypes of the query node to be included in the query results. A CI type tree appears with all the subtypes of the selected query node. By default, instances of all the displayed subtypes are included in the query results. For each subtype, you can select **Exclude <subtype> from the query** which excludes instances of that subtype from the query results. If you select the **Apply this condition recursively on all subtypes** check box, instances of the subtype and all of its descendants are excluded from the results.

If you select a subtype from the tree and you select **Include <subtype> in the query** without selecting the **Apply this condition recursively on all subtypes** check box, only instances of the specified subtype are included, but not instances of its descendants.

For both the Include and Exclude options, there is a further selection in the Conditions pane. If you select **By CI type**, all instances of the specified subtype are then included or excluded from the results. If you select **By qualifiers** and then select qualifiers from the pop-up list, only the instances of the selected subtype with the selected qualifiers are included or excluded from the query results.

For example, suppose CIT\_B and CIT\_C are subtypes of CIT\_A, and CIT\_A and CIT\_B have qualifier Q1. The following are some of the possible configurations of options:

- **Select Exclude for CIT\_A and all of its descendants.** No CITs are included.
- **Select Exclude for CIT\_A without its descendants.** Only CIT\_B and CIT\_C are included.

- **Select Exclude for CIT\_A and all of its descendants with qualifier Q1.** Only CIT\_C is included.

**Note:**

- It is possible to apply the Exclude option to the root of the tree (that is, the CI type of the original query node). If the **Apply this condition recursively on all subtypes** check box is selected, no CIs are included in the results. If the check box is not selected, instances of the root CI type are excluded, but instances of its descendants are included.
- The Element Type Conditions feature is only available in the Modeling Studio. If you define a complex type condition in the Modeling Studio, and then modify the TQL query in Enrichment Manager or Impact Analysis Manager, the condition may be overwritten and will no longer be in effect. If the complex condition is equivalent to a simple condition, you can edit the TQL query from the Qualifier tab of Enrichment Manager or Impact Analysis Manager.
- If you want to define a qualifier condition on a query node as using the functionality of previous UCMDB versions, select **Customize subtypes** and select the root query node in the CI types tree. Then select the **Include** option, select **By qualifiers**, and select the required qualifiers. Similarly, when accessing a TQL query with qualifier conditions defined in a previous UCMDB version or in Enrichment Manager or Impact Analysis Manager, the condition appears in the **Customize subtypes** section of the Element Type tab, using the **Include** and **By qualifiers** options.
- It is sometimes possible to define an attribute condition (using the CI Type attribute) that generates the same results as a complex type condition. However, the complex type condition ensures better performance. In such cases, UCMDB automatically optimizes the query calculation by substituting an equivalent complex type condition for the simple one. If the query is active, you will see the complex conditions in the TQL definition the next time you open it.

For details on defining a complex type condition, see ["How to Define a Complex Type Condition - Scenario" on page 32](#).

## Subgraph Definition

A subgraph definition enables you to create a graph that represents additional TQL query data related to a specific CI. The DFM job searches for the results from both the TQL query and the subgraph definitions. The query recursively retrieves all related CIs for a defined depth matching the definition of

the subgraph. For details on defining subgraph definitions, see ["Subgraph Definition Dialog Box" on page 91](#).

In the graph, you can define the relationship that is connected to a specific query node. For example, if one of the query nodes is of type node, you can specify different relationships for Windows, router, and IP Address. You can also define attribute conditions for query nodes. For details, see ["Subgraph Condition Definition Dialog Box" on page 89](#).

DFM jobs retrieve data that meets the criteria defined in the subgraph.

For an example of a subgraph definition, see ["How to Create a Subgraph Definition – Scenario" on page 33](#).

## The Use Update Value Policy Qualifier

This qualifier is used to mark attributes that enable minor deviations to their value. For example, there is probably no need to report a small disk size change (from 8.00008 to 8.00009 GB).

When updating an attribute that is marked with this qualifier, HP Universal CMDB checks the new value against the old value. This check is performed on the server as part of the record update. If the difference between the two values is smaller than the allowed deviation, an update is not performed (the action is considered a false update).

When the qualifier is selected, the **Insensitive Value Deviation** parameter applies. Enter a value in the box and select **Percent** or **Absolute Value** from the drop-down list.

When **Percent** is selected, the Insensitive Value Deviation must be between 0 and 100. Deviations of a smaller percentage than this value are considered false updates.

When **Absolute Value** is selected, the following rules apply:

- For numeric attributes, the Insensitive Value Deviation must be of the same type as the attribute
- For date attributes, the Insensitive Value Deviation must be an integer, and denotes the deviation in milliseconds

Deviations smaller than this value are considered false updates.

By default, **Use Update Value Policy** is enabled for the following numeric or date attributes only:

- CIT: Node
  - MemorySize
  - SwapMemorySize

These attributes also include comparable and static qualifiers.

- CIT: CPU
  - CpuClockSpeed
- CIT: Filesystem
  - Disk\_size

**To deactivate the qualifier:**

Access the Infrastructure Settings Manager (**Managers > Administration > Infrastructure Settings Manager**). Locate the **Allow Volatility** option. Change the value to **False**.

## How to Define a TQL Query

This task describes how to create a TQL query in the Modeling Studio.

**Note:** You can also create a TQL query during the procedure for creating Impact rules, Enrichment rules, Views, Templates, and Perspectives.

This task includes the following steps:

- ["Create a TQL Query" below](#)
- ["Add Query Nodes and Relationships to the Query" on the next page](#)
- ["Set the Query Properties" on the next page](#)

### 1. Create a TQL Query

In the Modeling Studio, select **New > Query** to open the TQL Query Editor. For details, see ["TQL Query Editor" on page 348](#).



## 2. Add Query Nodes and Relationships to the Query

Add the TQL query nodes and relationships that define the query. The TQL query nodes represent the CITs, as defined in the CI Type Manager, and the relationships represent the connections between them. Relationships are defined one at a time for each pair of TQL query nodes in the query. For details, see ["How to Add Query Nodes and Relationships to a TQL Query" on the next page.](#)

**Note:** You can also define a self-relationship from a query node to itself.

## 3. Set the Query Properties

Click the **Query Definition Properties**  button to open the Query Definition Properties dialog box. Set the query type, scope, priority, and other properties. For details, see ["Query/View Definition Properties Dialog Box" on page 335.](#)

### Example of a TQL Query Definition:

The direction of the relationship indicates which query node is dependent on the other. The following example displays two nodes, an IP Service Endpoint, and a Client Port, which are linked to one another via a client/server connection. The TQL query results must comply with the direction of the arrows.

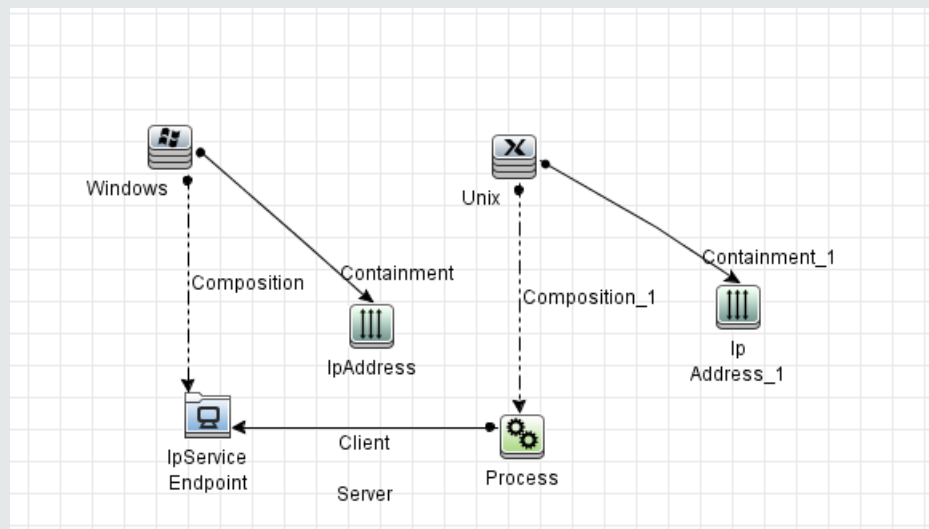

**Note:** A TQL query is subject to certain validation restrictions. For details, see

["Troubleshooting and Limitations – Topology Query Language" on page 94.](#)

## How to Add Query Nodes and Relationships to a TQL Query

This section explains how to add query nodes and relationships to a TQL query. It is relevant for Impact Analysis Manager, Enrichment Manager, and the Modeling Studio.

**Note:** For TQL queries to be valid, they must comply with certain restrictions. For details, see ["Troubleshooting and Limitations – Topology Query Language" on page 94.](#)

### To add query nodes and relationships to a TQL query:

1. In Impact Analysis Manager or Enrichment Manager, select the required query from the tree in the left pane or click the **New**  button to create one.

In the Modeling Studio, select the Resources tab in the left pane, select Queries as the Resource type, and select the required query from the tree or click **New > Query** to create a new one.

2. In Impact Analysis Manager or Enrichment Manager, click and drag one or more required TQL query nodes from the tree displayed in the CI Type Selector, onto the editing pane. In the Modeling Studio, select the CI Types tab in the left pane and drag the required TQL query nodes from the tree onto the editing pane. These are the TQL query nodes that are included in the query.

If you want the query to run over federated CIs also, right-click a query node and select Set Integration Points. In the Select Integration Points dialog box, select the integration points for the external data sources to use. For details, see ["Select Integration Points Dialog Box" on page 341.](#)

3. To add a relationship between two query nodes, do one of the following:
  - Select the required TQL query nodes by holding the **CTRL** key and clicking the TQL query nodes, right-click and select **Add Relationship**. The Add Relationship dialog box opens. Select the required relationship. For details, see ["Add/Edit Relationship Dialog Box" on page 54.](#)
  - Click the **Create Relationship**  icon and draw a line between the required query nodes. The Select Relationship Type dialog box opens. Select the required relationship type. For details, see

["Select Relationship Type Dialog Box" on page 88.](#)

4. Click **OK**. The selected query nodes are linked by the relationship you have selected.

## How to Define a Compound Relationship – Scenario

This section describes how to define the allowed steps that form a compound relationship between an **IP Subnet CI** and an **IP Address CI**.

**Note:** To reach the required result, you must implement each one of the following steps.

### To define a compound relationship between an IP Subnet CI and an IP Address CI:

1. Create a TQL query of type view and drag the following query nodes onto the editing pane:
  - IP Subnet
  - IP Address
2. Right-click the **IP Subnet** and **IP Address** query nodes and select **Add Compound Relationship** to open the Add Compound Relationship dialog box.
3. Click the **Add**  button. In Enrichment Manager and Impact Analysis Manager, the Add Triplet dialog box opens. In the Modeling Studio, a row is added to the table. Make the following selections:
  - From the **Source** list, select **IP Subnet**.
  - From the **Target** list, select **Node**.
  - From the **Relationship** list, select **Membership**.
  - Select the required **Relationship** direction.

In Enrichment Manager and Impact Analysis Manager, click **OK** to save your changes.

4. Click the **Add**  button again and make the following selections:
  - From the **Source** list, select **Node**.
  - From the **Target** list, select **IP Address**.

- From the **Relationship** list, select **Containment**.
- Select the required **Relationship** direction.

In Enrichment Manager and Impact Analysis Manager, click **OK** to save your changes.

The following shows an example of compound definitions following the changes:

Source	Relationship	Target
IpSubnet	Membership	Node
Node	Containment	IpAddress

5. Click **OK** to save your changes.

The TQL query in the editing pane now looks like this:

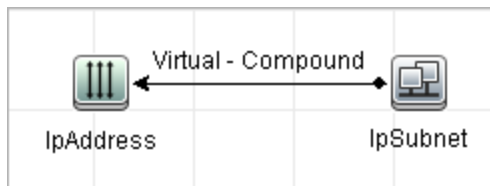

6. Create a view based on your TQL query and save it.
7. Go to the required view in IT Universe Manager to view the results. If you did not select the **Show full path between source and target CIs** option, then the results display the names of the relationships that link the CIs as **Virtual-Compound** rather than the actual names of the relationships. See the illustration below:

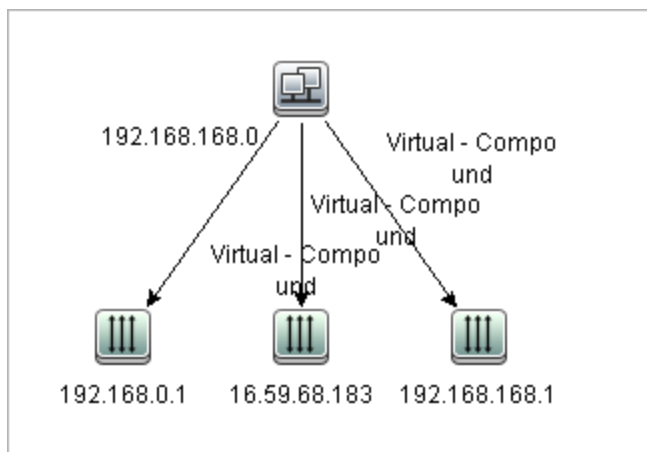

You can double-click the **Virtual - Compound** relationship in IT Universe Manager to open the Link Map, which displays the CIs and relationships that comprise the allowed steps used to link the **IP Subnet** and **IP Address** CIs.

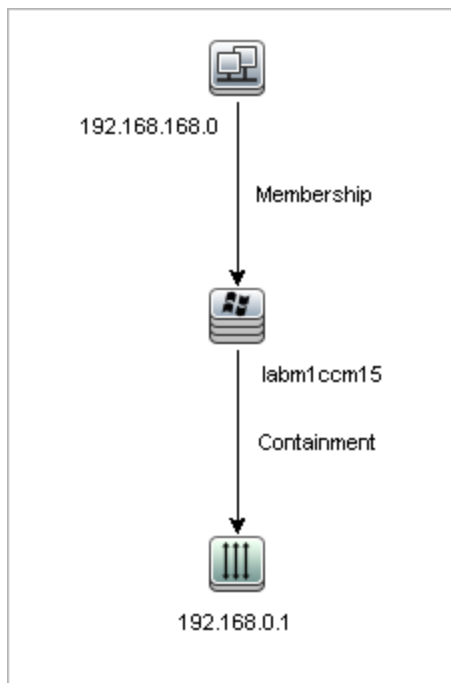

In the example above, the **192.168.168.0** (IP Subnet) CI is linked to the **192.168.0.1** (IP Address) CI through the **labm1ccm15** (Node) CI.

If you selected the **Show full path between source and target CIs** option, then the results in IT Universe Manager display the actual names of the relationships that link the CIs and the full path between the source and target CIs. See the illustration below:

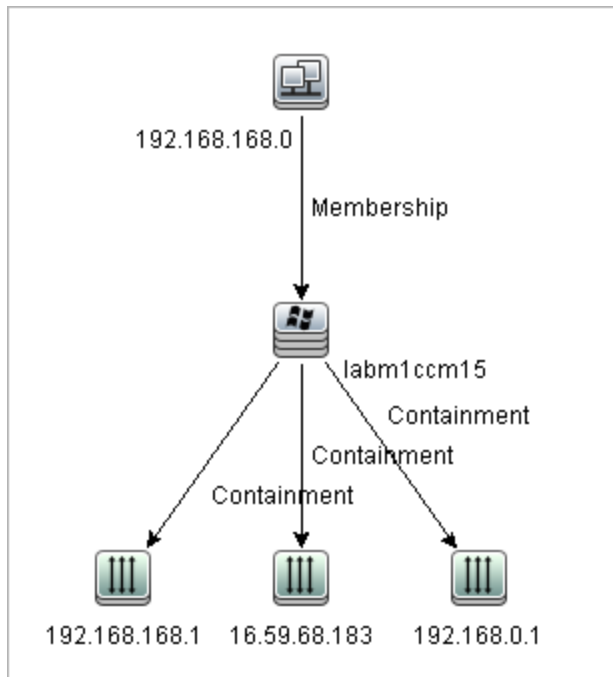

## How to Define a Join Relationship – Scenario

This section explains how to define a join relationship that links **Node** CIs to **IP Address** CIs whose **Created by** attribute values are equal.

**Note:** To reach the required result, you must implement each one of the following steps.

**To define a join relationship that links all IP Address and Node CIs whose Created by attribute values are equal:**

1. Create a TQL query and drag the following query nodes from the CI Type Selector onto the editing pane:
  - Node
  - IP Address
2. Select the **Node** and **IP Address** query nodes and right-click to open the Add Join Relationship dialog box.

3. Click the **Add**  button to add a row to the table and do the following:
  - In the **Node Attribute** box, select **Created by**.
  - In the **Operator** box, select **Equal**.
  - In the **IP Address Attribute** box, select **Created by**.

In Enrichment Manager and Impact Analysis Manager, you make these selections in the Join Relationship Condition dialog box.

The Join Definition area now looks like this:

Node	Operator	IpAddress
Created By	Equal	Created By

4. Click **OK** to save your changes.

The TQL query in the editing pane now looks like this:

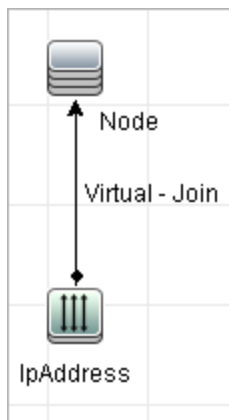

## How to Define an Attribute Condition – Scenario

This task describes how to define an attribute condition to select the **Node** CIs that were created or updated over the past week.

1. In the Modeling Studio, Enrichment Manager, or Impact Analysis Manager, open a TQL query, view, Enrichment rule, or Impact Analysis rule containing a Node CI.

2. Right-click the Node CI and select **Query Node Properties**.
3. In the Query Node Properties dialog box in the Attributes tab, click the **Add**  button to add a condition.
4. For the **Attribute name**, select **Create Time** from the drop-down list.
5. For the **Operator**, select **Changed During [Hour(s)]** from the drop-down list.
6. For the **Value**, enter **7**.
7. Click **OK** to save the attribute condition.

## How to Define a Complex Type Condition - Scenario

This section describes how to define a complex type condition in the Query Node Properties dialog box. In this example, you add subtype conditions to a Node query node in a TQL query.

### To define a complex type condition:

1. Create a TQL query and drag a query node of type Node onto the editing pane.
2. Right-click the query node and select Query Node Properties. The Query Node Properties dialog box opens.
3. Select the **Element Type** tab and select **Customize subtypes**.
4. In the CI Types pane, select **Computer**, and in the Conditions pane, select **Exclude <Computer> from the query**. Select the **Apply this condition recursively on all subtypes of <Computer>** check box. This excludes all CIs of type Computer and its descendants in the query results.
5. In the CI Types pane, select **Unix**, and in the Conditions pane, select **Include <Unix> in the query**. This includes all Unix CIs in the query results.
6. In the CI Types pane, select **IBM Frame**, and in the Conditions pane, select **Include <IBM Frame> in the query**. Then select **By qualifiers** and select the **CONTAINER** qualifier. This includes all IBM Frame CIs with the CONTAINER qualifier in the query results.
7. In the CI Types pane, select **Firewall**, and in the Conditions pane, select **Exclude <Firewall> from the query**. Select **By qualifiers** and select the **HIDDEN\_CLASS** and **MAJOR\_APP** qualifiers. This



excludes all Firewall CIs with the `HIDDEN_CLASS` and `MAJOR_APP` qualifiers from the query results.

8. Click **OK** to save your conditions and exit the dialog box.

## How to Create a Subgraph Definition – Scenario

This section describes how to create a subgraph definition. In this example, the TQL query results retrieve all CIs that are connected to a Business Service CI by a **Containment** relationship up to a depth of 3.





**Note:** To reach the required result, you must implement each one of the following steps.

### To create this sample subgraph definition:

1. Create a TQL query and drag a query node of type **Business Service** onto the editing pane.
2. Right-click the Business Service query node and select **Subgraph Definition** to open the Subgraph Definition dialog box.
3. Click the **Add**  button. In Enrichment Manager and Impact Analysis Manager, the Add Triplet dialog box opens. In the Modeling Studio, a row is added to the table. Make the following selections:
  - From the **Source** drop-down list, select **Managed Object**.
  - From the **Target** drop-down list, select **Managed Object**.
  - From the **Relationship** drop-down list, select **Containment**.
  - Set the direction of the relationship as left to right.

In Enrichment Manager and Impact Analysis Manager, click **OK** to save your changes.

The Subgraph Definition dialog box now looks like this:

Source	Relationship	Target	Relationship Direction
 Managed Object	 Containment	 Managed Object	

4. Set the **Depth** setting to **3**.
5. Click **OK** in the Subgraph Definition dialog box.

Go to the required view in IT Universe Manager to view the results.

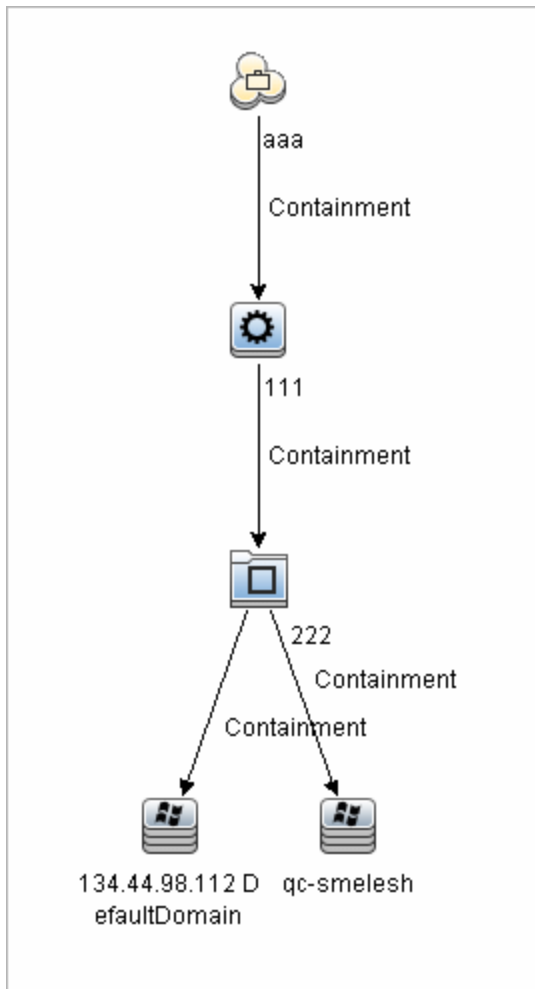



The results show the Business Service CI **aaa** and all of the CIs linked to it in succession by Containment relationships down to three levels.

## Shortcut Menu Options

This section includes a list of TQL query shortcut menu options:

UI Element (A-Z)	Description
<b>Add Calculated Relationship</b>	Enables you to create a calculated relationship. <ul style="list-style-type: none"> <li>For details on how to create a calculated relationship, see <a href="#">"Triplets Page" on page 514</a>.</li> </ul>

UI Element (A-Z)	Description
	<ul style="list-style-type: none"> <li>For details about Impact Modeling, see <a href="#">"Using Calculated Relationships" on page 99</a>.</li> </ul>
<b>Add Compound Relationship</b>	<p>Enables you to define the connection between two query nodes using a compound relationship.</p> <p>For details, see <a href="#">"Add/Edit Compound Relationship Dialog Box" on page 48</a>.</p>
<b>Add Join Relationship</b>	<p>Enables you to define join relationships. You create them by defining an attribute for each query node. These query node values are used for comparison during federation.</p> <p>For details, see <a href="#">"Add/Edit Join Relationship Dialog Box" on page 51</a>.</p>
<b>Add Related Query Node Wizard</b>	<p>Displays the Add Related Query Node Wizard which enables you to build a TQL query. For details, see <a href="#">"Add Related Query Node Wizard" on page 56</a>.</p>
<b>Add Relationship</b>	<p>Enables you to create a relationship for your query nodes by selecting it from a predefined list. Displays the Add Relationship dialog box.</p> <p>For details, see <a href="#">"Add/Edit Relationship Dialog Box" on page 54</a>.</p> <div data-bbox="488 999 1370 1209" style="background-color: #f0f0f0; padding: 10px; border: 1px solid #ccc;"> <p><b>Note:</b> In Enrichment Manager, this option adds an Enrichment relationship to the rule when working in <b>Enrichment</b> mode. Applicable for regular and Enrichment query nodes. For details, see <a href="#">"Enrichment Manager" on page 529</a>. Added relationships are denoted by an added  indicator.</p> </div>
<b>Add to Hierarchy</b>	<p>Adds the selected query node to the hierarchy as a separate query node.</p> <div data-bbox="488 1293 1370 1377" style="background-color: #f0f0f0; padding: 10px; border: 1px solid #ccc;"> <p><b>Note:</b> Only relevant for the Modeling Studio.</p> </div>
<b>Add to Model Output</b>	<p>Designates the selected query node as output for the pattern-based model.</p> <div data-bbox="488 1461 1370 1545" style="background-color: #f0f0f0; padding: 10px; border: 1px solid #ccc;"> <p><b>Note:</b> Only relevant for pattern-based models in the Modeling Studio.</p> </div>
<b>Change Query Node/Relationship Type</b>	<p>Displays the Change Query Node Type dialog box. Enables you to change the CI type of the query node after you have created it. For details, see <a href="#">"Change Query Node/Relationship Type Dialog Box" on page 290</a>.</p> <div data-bbox="488 1703 1370 1787" style="background-color: #f0f0f0; padding: 10px; border: 1px solid #ccc;"> <p><b>Note:</b> Only relevant for the Modeling Studio.</p> </div>
<b>Clear</b>	<p>Available by right-clicking a query node or relationship when working in <b>Enrichment</b> mode in the Enrichment Manager. Clears the query</p>

UI Element (A-Z)	Description
	<p>node/relationship's Enrichment rule definition. For details, see <a href="#">"Enrichment Manager" on page 529</a>.</p> <p>Appears only if you have updated or deleted a query node/relationship using an Enrichment rule.</p> <p><b>Note:</b> Only relevant for Enrichment Manager.</p>
<b>Copy/Paste</b>	<p>Copy/paste an existing TQL query node/relationship in the same query or into another TQL query.</p> <p>The copied TQL query node/relationship includes all TQL definitions.</p> <p>You can copy and paste relationships provided that the TQL query nodes to which the relationships are connected are also selected. A relationship on its own cannot be copied without its connecting TQL query nodes.</p> <p>You can select multiple TQL query nodes/relationships as well.</p> <p><b>Note:</b> The <b>Copy</b> and <b>Paste</b> options are only available in the Modeling Studio. The <b>Paste</b> option is available only after using the <b>Copy</b> option to copy an existing TQL query node/relationship.</p>
<b>Define Impacted</b>	<p>Defines which query node in the TQL query is the trigger Impact Analysis query node and which query nodes are impacted by the changes that occur in the system. For details, see <a href="#">"Impacted Query Nodes Dialog Box" on page 478</a>.</p> <p><b>Note:</b> Only relevant for Impact Analysis Manager.</p>
<b>Delete</b>	<p>Deletes the selected query node/relationship/CI.</p> <p><b>Note:</b> This option is not available for calculated relationships.</p>
<b>Delete Relationship/Query Node</b>	<p>Available by right-clicking a query node or relationship when working in <b>Enrichment</b> mode.</p> <p>Creates a specific Enrichment rule that is designed to delete CIs/relationships from the CMDB. Applicable to regular query nodes and relationships only. You can use this option, for example, for removing unnecessary data from the CMDB. For details, see <a href="#">"Enrichment Manager" on page 529</a>.</p> <p>Deleted query nodes and relationships are denoted by a removed  indicator.</p>

UI Element (A-Z)	Description
	<p><b>Note:</b> Only relevant for Enrichment Manager.</p>
<b>Edit Relationship</b>	<p>Displays the Refine Relationship Type dialog box. For details, see <a href="#">"Refine Query Node Type Dialog Box"</a> on page 87.</p> <p><b>Note:</b></p> <ul style="list-style-type: none"> <li>• Not relevant in the Modeling Studio.</li> <li>• This option appears only when the selected relationship has descendants.</li> </ul>
<b>Hide Element in Query Results</b>	<p>When this option is selected, a <b>Hidden in Query Results</b> indicator  appears to the right of the selected TQL query node in the editing pane.</p> <p>Any query results pertaining to that TQL query node are not displayed in the topology map. This can be useful when certain relationships or TQL query nodes are required to build the query but are not needed in the results. At least one query node must be visible for the view to be valid.</p> <p><b>Note:</b> Only relevant for the Modeling Studio.</p>
<b>Hide Element in View Results</b>	<p>Hides the selected virtual-compound relationship when viewing the results of an Automated Service Map in the UCMDB Browser (based on the Service_ template perspective being applied on top of the service's Business Element CI), as long as the CIs linked by the virtual-compound relationship are not linked by any other relationship.</p> <p><b>Note:</b></p> <ul style="list-style-type: none"> <li>• This option appears only when you are creating or editing the perspective on which a service model is based. Only relevant for the Modeling Studio.</li> <li>• If the <b>Hide Element in Query Results</b> option is selected for a node, this option will not be available, since the node and all of its relationships will not appear.</li> </ul>
<b>Query Node/Relationship Properties</b>	<p>Displays the Query Node/Relationship Properties dialog box, enabling you to define the attribute conditions for the selected TQL query node/relationship. For details, see <a href="#">"Query Node/Relationship Properties Dialog Box"</a> on page 73.</p>

UI Element (A-Z)	Description
	<p><b>Note:</b> This option is not available for calculated relationships.</p>
<b>Refine Query Node Type</b>	<p>Displays the Refine Query Node Type dialog box. Enables you to change the CI type of the query node after you have created it. For details, see <a href="#">"Refine Query Node Type Dialog Box" on page 87</a>.</p> <p><b>Note:</b> This option only appears if a child of the CI type exists. Only relevant for Impact Analysis Manager and Enrichment Manager.</p>
<b>Remove Subgraph</b>	<p>Only appears if you have defined a subgraph definition. For details, see <a href="#">"Subgraph Definition Dialog Box" on page 91</a>.</p>
<b>Reset Impacted</b>	<p>Removes the Define Impacted definition applied to that query node. For details on the Define Impacted definition, see <a href="#">"Impacted Query Nodes Dialog Box" on page 478</a>.</p> <p><b>Note:</b> Only relevant for Impact Analysis Manager.</p>
<b>Reset Inner Relationship</b>	<p>Redraws a self-referential relationship in the Topology map as a square for ease of viewing.</p> <p><b>Note:</b> Only relevant for self-referential relationships that are not square.</p>
<b>Select All</b>	<p>Selects all query nodes and relationships in the TQL query.</p> <p><b>Note:</b> Only relevant for the Modeling Studio.</p>
<b>Set As Contact Query Node</b>	<p>Designates the selected query node as a contact query node for the perspective.</p> <p><b>Note:</b> Only relevant for perspectives in the Modeling Studio.</p>
<b>Set Integration Points</b>	<p>Opens the Select Integration Points dialog box which enables you to select the required data sources for a TQL query node.</p> <p><b>Note:</b> Only relevant for the Modeling Studio.</p>
<b>Show Element in Query Results</b>	<p>When this option is selected, the results pertaining to the TQL query node are displayed in the topology map.</p>

UI Element (A-Z)	Description
	<p><b>Note:</b> Only relevant for the Modeling Studio.</p>
<p><b>Show Element in View Results</b></p>	<p>Displays the selected virtual-compound relationship when viewing the results of an Automated Service Map in the UCMDB Browser (based on the Service_ template perspective being applied on top of the service's Business Element CI).</p> <p><b>Note:</b></p> <ul style="list-style-type: none"> <li>• This option appears only when you are creating or editing the perspective on which a service model is based. Only relevant for the Modeling Studio.</li> <li>• If the <b>Show Element in Query Results</b> option is selected for a node, this option will not be available, since the node and all of its relationships are already displayed.</li> </ul>
<p><b>Show Element instances</b></p>	<p>Displays the CI Instances dialog box which displays all the instances found for each query node in a table. For details, see "<a href="#">CI Instances Dialog Box</a>" on <a href="#">page 66</a>.</p>
<p><b>Show Node Parameters</b></p>	<p>Opens the Template Parameter Values dialog box, which enables you to set the values of the query node's parameters.</p> <p><b>Note:</b> Only relevant for template-based views in the Modeling Studio.</p>
<p><b>Subgraph Definition</b></p>	<p>Displays the Subgraph Definition dialog box, where you can create a graph that represents additional TQL query data related to a specific query node. For details, see "<a href="#">Subgraph Definition Dialog Box</a>" on <a href="#">page 91</a>.</p>
<p><b>Update Relationship/Query Node</b></p>	<p>Use an Enrichment rule to update the value of CI attributes in the CMDB, or to add data to attributes that currently do not have values. Opens the Query Node Definition - Attributes dialog box. For details, see "<a href="#">Query Node/Relationship Definition Dialog Box</a>" on <a href="#">page 555</a>. This is applicable for both regular and Enrichment query nodes.</p> <p>Updated query nodes are denoted by an updated  indicator.</p> <p><b>Note:</b> Only relevant for Enrichment Manager.</p>

## Attribute Operator Definitions

This section contains a list of operators used to define attribute conditions in various dialog boxes, such as the Subgraph Condition dialog box, Impact Rules Definition dialog box, or the Query Node/Relationship Properties dialog box.

Operator	Description
<b>Changed during</b>	(Displayed only when you select an attribute of type Date.) Displays only the instances that changed during the period specified in the <b>Value</b> box.
<b>Equal</b>	Checks whether the attribute value is equal to the value specified in the <b>Value</b> box.
<b>Equal ignore case</b>	Checks whether the attribute value is equal to the value specified in the <b>Value</b> box regardless of the case.  <b>Note:</b> When working with Microsoft SQL Server, this option is identical to <b>Equal</b> .
<b>Greater</b>	Checks whether the attribute value is greater than the value specified in the <b>Value</b> box.  <b>Note:</b> When comparing attributes of type <b>string</b> , the comparison is based on the ASCII values of the string characters.
<b>Greater than or equal</b>	Checks whether the attribute value is greater than or equal to the value specified in the <b>Value</b> box.
<b>In</b>	Displays only the instances where this attribute value equals one of the selected values. For example, for CIs that have a Change state that equals Plan and New, select the operator <b>In</b> from the <b>Operator</b> list and select both <b>Plan</b> and <b>New</b> from the <b>Value</b> box.
<b>In ignore case</b>	Displays only the instances where this attribute value equals one of the selected values, regardless of the case.  <b>Note:</b> When working with Microsoft SQL Server, this option is identical to <b>In</b> .
<b>Is null</b>	Checks whether the attribute value is null.



Operator	Description
<b>Less</b>	Checks whether the attribute value is less than the value specified in the <b>Value</b> box.  <div style="background-color: #f0f0f0; padding: 5px;"> <b>Note:</b> When comparing attributes of type <b>string</b>, the comparison is based on the ASCII values of the string characters.                     </div>
<b>Less than or equal</b>	Checks whether the attribute value is less than or equal to the value specified in the <b>Value</b> box.
<b>Like</b>	Uses a wildcard (%). Use <b>Like</b> when you are not sure of the complete name for which you are searching.
<b>Like ignore case</b>	Uses a wildcard (%). Use <b>Like ignore case</b> when you are not sure of the complete name for which you are searching. The case of the string is ignored.  <div style="background-color: #f0f0f0; padding: 5px;"> <b>Note:</b> When working with Microsoft SQL Server, this option is identical to <b>Like</b>.                     </div>
<b>Not equal</b>	Checks whether the attribute value is not equal to the value specified in the <b>Value</b> box.
<b>Occurs after</b>	(Displayed when you select a date type attribute.) Displays only the instances that occurred after the period specified in the <b>Value</b> box.
<b>Occurs within</b>	(Displayed when you select a date type attribute.) Displays only the instances that occurred within the period specified in the <b>Value</b> box.
<b>Unchanged during</b>	(Displayed when you select a date type attribute.) Displays only the instances that did not change during the period specified in the <b>Value</b> box.

**Note:**

- For the **Not equal** operator, query results do not include data from the CI instances that are not assigned a value. For example, a system contains three nodes: Node1 is assigned the value A, Node2 is assigned the value B, and Node3 is not assigned a value. If you create a query to retrieve all nodes that are **Not equal** to A, the results of your query include Node2 only, because Node3 is not assigned a value.
- HP Universal CMDB supports both Microsoft SQL Server and Oracle Server databases. Microsoft SQL Server is not case sensitive by default (unlike Oracle database which is case sensitive).

Consequently, if you are using Microsoft SQL Server, the **Equal** operator retrieves the same query results as the **Equal ignore case** operator. For example, if you select the attribute **City**, the operator **Equal**, and type **NEW YORK** in the **Value comparison** box, case differences are ignored and query results include **NEW YORK, New York** and **new york**.

## TQL Logs

This section contains definitions for TQL parameter log files.

This section includes the following topics:

- ["Pattern Statistics Log" below](#)
- ["Audit Short/Detailed Log \(TQL Perspective\)" on the next page](#)
- ["Incremental Statistics Log" on page 44](#)
- ["Incremental Splitter Log" on page 44](#)
- ["Incremental Detailed Log" on page 45](#)

### Pattern Statistics Log

The log name is **cmdb.pattern.statistics.log**.

Log File	Description
Purpose	General calculation data for each TQL query, updated at predefined intervals.
Information Level	The following information is given for each TQL query: <ul style="list-style-type: none"><li>• name</li><li>• average, minimum, and maximum calculation times</li><li>• number of calculations</li><li>• last calculation time</li><li>• result size</li></ul>

Log File	Description
Error Level	Not available.
Debug Level	Not available.
Basic Troubleshooting	<ul style="list-style-type: none"> <li>• Verify that a specific TQL query was updated.</li> <li>• Evaluate a TQL query's calculation time.</li> <li>• Evaluate a TQL query's result size.</li> </ul>

### Audit Short/Detailed Log (TQL Perspective)

The log name is **cmdb.audit.short.log**.

Log File	Description
Purpose	CMDB state changes, CI Type changes, and TQL query results. You can use this log to follow the results of TQL queries.
Information Level	Not available.
Error Level	Not available.
Debug Level	<ul style="list-style-type: none"> <li>• Final calculation for TQL queries is logged.</li> <li>• If the final TQL query calculation is unchanged from the previous calculation, this is noted.</li> <li>• If the final TQL query calculation is changed from the previous calculation, results of the CIs and relationships are recorded in the detailed log. The number of CIs and relationships are recorded in the short log.</li> </ul>
Basic Troubleshooting	<ul style="list-style-type: none"> <li>• Use this log to verify which notifications are published by the TQL query subsystem.</li> <li>• Check the section at the end of each result. This section includes added, removed, and updated CIs and relationships.</li> <li>• Track the CIT changes and see if the query results also change. You can thus correlate the CIT changes to the results of the query calculations.</li> </ul>

## Incremental Statistics Log

The log name is **cmdb.incremental.statistics.log**.

Log File	Description
Purpose	Traces the calculation procedure, full or incremental, of every query.
Information Level	Not available.
Error Level	Not available.
Debug Level	<ul style="list-style-type: none"> <li>• Gives the date, time, query name, and whether an incremental statistic calculation was performed (yes/no).</li> <li>• If an incremental statistic calculation was not performed, states the reason, the number of subcalculations (relevant for incremental calculations only), and the complete calculation time.</li> </ul>
Basic Troubleshooting	<p>Monitors the calculation process.</p> <p>If a specific query calculation takes a long time, check if it is a full or incremental calculation:</p> <ul style="list-style-type: none"> <li>• If full, check whether a full calculation is necessary.</li> <li>• If incremental, check how many subcalculations have been performed.</li> </ul>

## Incremental Splitter Log

The log name is **cmdb.incremental.splitter.log**.

Log File	Description
Purpose	Monitors the incremental splitter result made during an incremental calculation.
Information Level	Not available.
Error Level	Not available.
Debug Level	Gives the set of query node numbers of each query graph created by the incremental splitter.
Basic Troubleshooting	If the TQL result calculated by the incremental calculator is wrong, verify that the splitter result is correct.

## Incremental Detailed Log

The log name is **cmdb.incremental.detailed.log**.

Log File	Description
Purpose	Monitors the incremental calculation process.
Information Level	Not available.
Error Level	Not available.
Debug Level	Each incremental subcalculation entry includes the following: <ul style="list-style-type: none"> <li>• the trigger query node</li> <li>• the number of elements classified to the trigger query node</li> <li>• whether the subcalculation step is driven by new elements added to the model or by existing elements</li> <li>• the calculated query graph</li> </ul>
Basic Troubleshooting	Follows the basic steps of an incremental calculation.

## Topology Query Language User Interface

This section includes (in alphabetical order):

Add/Edit Calculated Relationship Dialog Box .....	46
Add/Edit Compound Relationship Dialog Box .....	48
Add/Edit Join Relationship Dialog Box .....	51
Add/Edit Relationship Dialog Box .....	54
Add Related Query Node Wizard .....	56
Add Triplet Dialog Box .....	63
CI Instances Dialog Box .....	66
Conditions Preview Dialog Box .....	69
Element Layout Preview Dialog Box .....	69

Filter CI Instances Dialog Box ..... 70

Join Relationship Condition Dialog Box ..... 71

Layout Settings Dialog Box ..... 72

Query Node/Relationship Properties Dialog Box ..... 73

Refine Query Node Type Dialog Box ..... 87

Select Relationship Type Dialog Box ..... 88

Subgraph Condition Definition Dialog Box ..... 89

Subgraph Definition Dialog Box ..... 91

User Preferences Dialog Box ..... 93



## Add/Edit Calculated Relationship Dialog Box

This dialog box enables you to define the connection between two query nodes using a calculated relationship from the CI Type model.

<p><b>To access</b></p>	<p>To access in Enrichment Manager, Impact Analysis Manager, and the Modeling Studio:                  Right-click the required query node in the editing pane in Enrichment Manager, Impact Analysis Manager, or the Modeling Studio and select <b>Add Calculated Relationship</b>.</p> <div style="background-color: #f0f0f0; padding: 5px; margin: 10px 0;"> <p><b>Note:</b> If you are using Enrichment Manager, select <b>Query</b> mode at the top of the editing pane to display the <b>Add Calculated Relationship</b> option.</p> </div> <p>To access in Adapter Management in Data Flow Management (DFM):</p> <ol style="list-style-type: none"> <li>1. Select an adapter in the Resources pane.</li> <li>2. In the <b>Adapter Definition</b> tab, click the <b>Edit Input Query</b>  button to the right of the <b>Input Query</b> box to open the Input Query Editor.</li> <li>3. Right-click the required query node and select <b>Add Calculated Relationship</b>.</li> </ol>
<p><b>Relevant tasks</b></p>	<ul style="list-style-type: none"> <li>• <a href="#">"How to Define an Impact Rule – Workflow" on page 467</a></li> <li>• <a href="#">"How to Define an Enrichment Rule – Scenario" on page 531</a></li> <li>• <a href="#">"How to Define a TQL Query" on page 24</a></li> <li>• "Implement a Discovery Adapter" in the <i>HP Universal CMDB Developer Reference Guide</i></li> </ul>

	<ul style="list-style-type: none"> <li>• <a href="#">"How to Create a Pattern View" on page 271</a></li> <li>• <a href="#">"How to Create a Template" on page 273</a></li> <li>• <a href="#">"How to Create a Perspective" on page 274</a></li> </ul>
<b>See also</b>	<ul style="list-style-type: none"> <li>• <a href="#">"Using Calculated Relationships" on page 99</a></li> <li>• <a href="#">"CI Type Relationships" on page 488</a></li> </ul>

User interface elements are described below (unlabeled elements are shown in angle brackets>):

UI Element	Description
	<b>Expand All.</b> Expands all the folders in the tree.
	<b>Collapse All.</b> Collapses all the folders in the tree.
<b>Tree View</b> 	<p><b>Tree View.</b> Enables you to select the display format of the calculated relationship tree. The following options are available:</p> <ul style="list-style-type: none"> <li>• by Display label</li> <li>• by Class name</li> <li>• by Legacy class name</li> </ul>
<b>&lt;Calculated relationship tree&gt;</b>	Select the calculated relationship that defines the connection between two query nodes.
<b>Relationship Direction</b>	The direction of the relationship that indicates which query node is dependent on the other.
<b>Relationship Name</b>	The name of the calculated relationship.
<b>Relationship Restrictions</b>	<p>Select an option to define how to handle relationships between identical query nodes or self relationships in the query results. A self relationship is a relationship that leads from a query node to itself.</p> <div style="background-color: #f0f0f0; padding: 10px; margin: 10px 0;"> <p><b>Note:</b> This list appears only when you select one query node or two identical query nodes.</p> </div> <ul style="list-style-type: none"> <li>• <b>Allow All Relationships.</b> All relationships appear in the query results.</li> <li>• <b>Allow Self Relationships Only.</b> Only self-relationships (a relationship that leads to</li> </ul>

UI Element	Description
	itself) appear in the query results. <ul style="list-style-type: none"> <li>• <b>Allow Non Self Relationships Only.</b> Self-relationships do not appear in the query results.</li> </ul>

## Add/Edit Compound Relationship Dialog Box



This dialog box enables you to define the connection between two query nodes using a compound relationship.

<p><b>To access</b></p>	<p>To access in Enrichment Manager, Impact Analysis Manager, and the Modeling Studio:</p> <p>Right-click the required query nodes in the editing pane in Enrichment Manager, Impact Analysis Manager, or the Modeling Studio and select <b>Add Compound Relationship</b>.</p> <div style="background-color: #f0f0f0; padding: 5px; margin: 10px 0;"> <p><b>Note:</b> If you are using Enrichment Manager, select <b>Query</b> mode at the top of the editing pane to display the <b>Add Compound Relationship</b> option.</p> </div> <p>To access in Adapter Management in DFM:</p> <ol style="list-style-type: none"> <li>1. Select an adapter in the Resources pane.</li> <li>2. In the <b>Adapter Definition</b> tab, click the <b>Edit Input Query</b>  button to the right of the <b>Input Query</b> box to open the Input Query Editor.</li> <li>3. Right-click the required query node and select <b>Add Compound Relationship</b>.</li> </ol>
<p><b>Important information</b></p>	<p>You can create as many compound definitions as necessary.</p>
<p><b>Relevant tasks</b></p>	<ul style="list-style-type: none"> <li>• <a href="#">"How to Define an Impact Rule – Workflow" on page 467</a></li> <li>• <a href="#">"How to Define an Enrichment Rule – Scenario" on page 531</a></li> <li>• <a href="#">"How to Define a TQL Query" on page 24</a></li> <li>• "Implement a Discovery Adapter" in the <i>HP Universal CMDB Developer Reference Guide</i></li> <li>• <a href="#">"How to Create a Pattern View" on page 271</a></li> </ul>



	<ul style="list-style-type: none"> <li>• <a href="#">"How to Create a Template" on page 273</a></li> <li>• <a href="#">"How to Create a Perspective" on page 274</a></li> </ul>
<b>See also</b>	<ul style="list-style-type: none"> <li>• <a href="#">"Compound Relationship" on page 18</a></li> <li>• <a href="#">"How to Define a Compound Relationship – Scenario" on page 27</a></li> </ul>

User interface elements are described below:

<b>UI Element (A-Z)</b>	<b>Description</b>
	<p><b>Add.</b> Adds a compound definition.</p> <p>In Impact Analysis Manager, Enrichment Manager, and the Input Query Editor in DFM, it opens the Add Triplet dialog box. In the Modeling Studio, it enters a default compound definition in the table. Click the <b>Edit</b> buttons to edit the definition components.</p>
	<p><b>Delete.</b> Deletes the selected compound definition.</p>
	<p><b>Condition.</b> Enables you to edit the selected compound definition.</p> <p>In Impact Analysis Manager, Enrichment Manager, and the Input Query Editor in DFM, it opens the Edit Triplet dialog box. In the Modeling Studio, it opens the Compound Relationship Condition Definition dialog box.</p>
<b>Max steps</b>	<p>The longest path allowed between the two CIs in the CMDB to be included in the discovery process.</p> <p><b>Default: 5</b></p>
<b>Min steps</b>	<p>The shortest path allowed between the two CIs in the CMDB to be included in the discovery process.</p> <p><b>Default: 1</b></p>
<b>Relationship</b>	<p>The relationship connecting the two query nodes.</p>
<b>Relationship Direction</b>	<p>The direction of the relationship that indicates which query node is dependent on the other.</p>
<b>Relationship Name</b>	<p>The name of the compound relationship.</p>
<b>Relationship Restrictions</b>	<p>Select an option to define how to handle relationships between identical query nodes or self relationships in the query results. A self relationship is a relationship that leads from a query node to itself.</p>

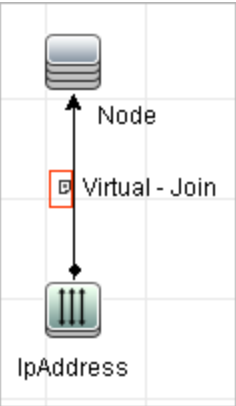
UI Element (A-Z)	Description
	<p><b>Note:</b> This list appears only when you select one query node or two identical query nodes.</p> <ul style="list-style-type: none"> <li>• <b>Allow All Relationships.</b> All relationships appear in the query results.</li> <li>• <b>Allow Self Relationships only.</b> Only self-relationships (a relationship that leads to itself) appear in the query results.</li> <li>• <b>Allow Non Self Relationships only.</b> Self-relationships do not appear in the query results.</li> </ul>
<p><b>Show element in query results</b></p>	<p>Select <b>Show element in query results</b> to include query results relating to a join or compound relationship. By default, this option is selected. When the check box is cleared, a <b>Hidden in Query Results</b> indicator <input type="checkbox"/> appears to the left of the relationship's name in the editing pane, denoting that any query results pertaining to the relationship are not displayed in the topology map.</p>  <p>The diagram shows a vertical flow of elements in a grid. At the top is a server icon labeled 'Node'. Below it is a relationship labeled 'Virtual - Join' with a small square checkbox to its left. At the bottom is a server icon labeled 'IpAddress'. Arrows point from 'Node' down to 'Virtual - Join' and from 'Virtual - Join' down to 'IpAddress'.</p>
<p><b>Show full path between source and target CIs</b></p>	<p>If you select this option, then the query results display the actual names of the relationships that link the CIs and the full path between the source and target CIs.</p>
<p><b>Source</b></p>	<p>The required source query node.</p>
<p><b>Stop at first compound level</b></p>	<p>Select this option if you want the system to stop looking for TQL query results once it reaches the first target in the path.</p> <p>In the following sample compound link definition, <b>Depth</b> is defined as 10 and <b>Stop at first compound level</b> is selected.</p>

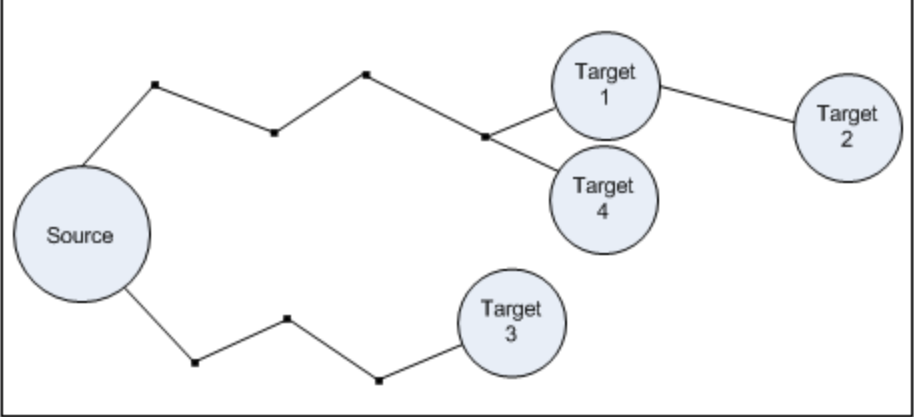
UI Element (A-Z)	Description
	 <p>The TQL query results include the <b>Target 1</b>, <b>Target 3</b>, and <b>Target 4</b> because they are all at level 1 (the first CI found in the path). <b>Target 2</b> is not included in the TQL results because it is at level 2 (the second CI found in the path).</p>
<b>Target</b>	The required target query node.



## Add/Edit Join Relationship Dialog Box

This dialog box enables you to define join relationships.

<b>To access</b>	<p>To access in Enrichment Manager, Impact Analysis Manager, and the Modeling Studio:                      Right-click the required query nodes in the editing pane in Enrichment Manager, Impact Analysis Manager, or the Modeling Studio and select <b>Add Join Relationship</b>.</p> <p><b>Note:</b> If you are using Enrichment Manager, select <b>Query</b> mode at the top of the editing pane to display the <b>Add Join Relationship</b> option.</p> <p>To access in Adapter Management in DFM:</p> <ol style="list-style-type: none"> <li>1. Select an adapter in the Resources pane.</li> <li>2. In the <b>Adapter Definition</b> tab, click the <b>Edit Input Query</b>  button to the right of the <b>Input Query</b> box to open the Input Query Editor.</li> <li>3. Right-click the required query node and select <b>Add Join Relationship</b>.</li> </ol>
<b>Important information</b>	When you access the dialog box from the Modeling Studio, you select the attributes and operator within the dialog box itself. When you access the dialog box from Impact

	<p>Analysis Manager or Enrichment Manager, you select the attributes and operator from the Join Relationship Condition dialog box.</p> <p><b>Note:</b> You cannot select attributes of type list for a join relationship condition.</p>
<b>Relevant tasks</b>	<ul style="list-style-type: none"> <li>• <a href="#">"How to Define an Impact Rule – Workflow" on page 467</a></li> <li>• <a href="#">"How to Define an Enrichment Rule – Scenario" on page 531</a></li> <li>• <a href="#">"How to Define a TQL Query" on page 24</a></li> <li>• "Implement a Discovery Adapter" in the <i>HP Universal CMDB Developer Reference Guide</i></li> <li>• <a href="#">"How to Create a Pattern View" on page 271</a></li> <li>• <a href="#">"How to Create a Template" on page 273</a></li> <li>• <a href="#">"How to Create a Perspective" on page 274</a></li> </ul>
<b>See also</b>	<ul style="list-style-type: none"> <li>• <a href="#">"Join Relationship" on page 18</a></li> <li>• <a href="#">"How to Define a Join Relationship – Scenario" on page 30</a></li> </ul>

User interface elements are described below (unlabeled elements are shown in angle brackets):

<b>UI Element (A-Z)</b>	<b>Description</b>
	<p><b>Add.</b> Enables you to define a join definition. In Impact Analysis Manager, Enrichment Manager and the Input Query Editor in DFM, it opens the Join Relationship Condition dialog box. In the Modeling Studio, it adds the selected attributes and operator to the list.</p>
	<p><b>Delete.</b> Deletes the selected join definition.</p>
	<p><b>Edit.</b> Enables you to edit the join definition. Opens the Join Relationship Condition dialog box.</p> <p><b>Note:</b> This option is not relevant in the Modeling Studio.</p>
<b>&lt;Query node1 Attribute&gt; box</b>	<p>Select an attribute for the &lt;end_1&gt; query node.</p> <p><b>Note:</b> This option is only available in the Modeling Studio.</p>

UI Element (A-Z)	Description
<b>&lt;Query node2 Attribute&gt; box</b>	Select an attribute for the <end_2> query node.  <div style="background-color: #f0f0f0; padding: 5px;"><b>Note:</b> This option is only available in the Modeling Studio.</div>
<b>&lt;Selected query node1&gt; column</b>	A selected query node. The first attribute applies to <end_1>.
<b>&lt;Selected query node2&gt; column</b>	A selected query node. The second attribute applies to <end_2>.
<b>And</b>	All join definitions are linked by the <b>And</b> operator.  <div style="background-color: #f0f0f0; padding: 5px;"><b>Note:</b> This is not relevant in the Modeling Studio.</div>
<b>Operator box</b>	Select an operator. For details on the available operators, see <a href="#">"Join Relationship Condition Dialog Box" on page 71</a> .  <div style="background-color: #f0f0f0; padding: 5px;"><b>Note:</b> This option is only available in the Modeling Studio.</div>
<b>Operator column</b>	The operator selected in the Join Relationship Condition dialog box. For details about operator definitions, see <a href="#">"Attribute Operator Definitions" on page 40</a> .
<b>Relationship Direction</b>	The direction of the relationship that indicates which query node is dependent on the other.
<b>Relationship Name</b>	The name of the join relationship.
<b>Relationship Restrictions</b>	Select an option to define how to handle relationships between identical query nodes or self relationships in the query results. A self relationship is a relationship that leads from a query node to itself.  <div style="background-color: #f0f0f0; padding: 5px;"><b>Note:</b> This list appears only when you select one query node or two identical query nodes.</div> <ul style="list-style-type: none"> <li>• <b>Allow All Relationships.</b> All relationships appear in the query results.</li> </ul>

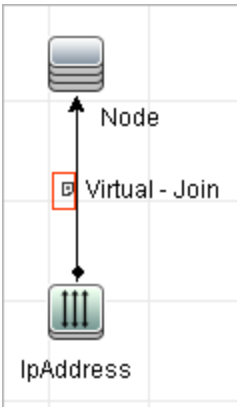
UI Element (A-Z)	Description
	<ul style="list-style-type: none"> <li>• <b>Allow Self Relationships only.</b> Only self-relationships (a relationship that leads to itself) appear in the query results.</li> <li>• <b>Allow Non Self Relationships only.</b> Self-relationships do not appear in the query results.</li> </ul>
<p><b>Show relationship in query results</b></p>	<p>Select <b>Show relationship in query results</b> to include query results relating to a join or compound relationship. By default, this option is selected. When the check box is cleared, a <b>Hidden in Query Results</b> indicator <input type="checkbox"/> appears to the left of the relationship's name in the editing pane. Any query results pertaining to the relationship are not displayed in the topology map.</p> 



## Add/Edit Relationship Dialog Box

This dialog box enables you to define the connection between two query nodes in a TQL query.

<p><b>To access</b></p>	<p>To access in Enrichment Manager, Impact Analysis Manager, and the Modeling Studio, do one of the following:</p> <ul style="list-style-type: none"> <li>• Right-click the required query node in the editing pane in Enrichment Manager, Impact Analysis Manager, or the Modeling Studio and select <b>Add Relationship</b>.</li> <li>• Click the <b>Create Relationship</b>  button and draw a line between the required query nodes. The Select Relationship Type dialog box opens. Select <b>Regular Relationship</b>.</li> </ul> <p><b>Note:</b> If you are using Enrichment Manager, select <b>Query</b> mode at the top of the editing pane to display the <b>Add Relationship</b> option.</p>
-------------------------	---

	<p>To access in Adapter Management in DFM:</p> <ol style="list-style-type: none"> <li>1. Select an adapter in the Resources pane.</li> <li>2. In the <b>Adapter Definition</b> tab, click the <b>Edit Input Query</b>  button to the right of the <b>Input Query</b> box to open the Input Query Editor.</li> <li>3. Right-click the required query node and select <b>Add Relationship</b>.</li> </ol>
<b>Important information</b>	This option does not appear when two selected query nodes (or a single selected query node) do not have a valid relationship between them.
<b>Relevant tasks</b>	<ul style="list-style-type: none"> <li>• <a href="#">"How to Define an Impact Rule – Workflow" on page 467</a></li> <li>• <a href="#">"How to Define an Enrichment Rule – Scenario" on page 531</a></li> <li>• <a href="#">"How to Define a TQL Query" on page 24</a></li> <li>• "Implement a Discovery Adapter" in the <i>HP Universal CMDB Developer Reference Guide</i></li> <li>• <a href="#">"How to Create a Pattern View" on page 271</a></li> <li>• <a href="#">"How to Create a Template" on page 273</a></li> <li>• <a href="#">"How to Create a Perspective" on page 274</a></li> </ul>
<b>See also</b>	<ul style="list-style-type: none"> <li>• <a href="#">"How to Add Query Nodes and Relationships to a TQL Query" on page 26</a></li> <li>• <a href="#">"CI Type Relationships" on page 488</a></li> </ul>

User interface elements are described below (unlabeled elements are shown in angle brackets>):

<b>UI Element (A-Z)</b>	<b>Description</b>
	<b>Expand All.</b> Expands all the folders in the relationship tree.
	<b>Collapse All.</b> Collapses all the folders in the relationship tree.
<b>Tree View</b> 	<p><b>Tree View.</b> Enables you to select the display format of the relationship tree. The following options are available:</p> <ul style="list-style-type: none"> <li>• by Display label</li> <li>• by Class name</li> </ul>



UI Element (A-Z)	Description
	<ul style="list-style-type: none"> <li>• by Legacy class name</li> </ul>
<b>&lt;Relationship tree&gt;</b>	Select the relationship that defines the connection between two query nodes.
<b>Relationship Direction</b>	The direction of the relationship that indicates which query node is dependent on the other.
<b>Relationship Name</b>	The name of the relationship.
<b>Relationship Restrictions</b>	<p>Select an option to define how to handle relationships between identical query nodes or self relationships in the query results. A self relationship is a relationship that leads from a query node to itself.</p> <div data-bbox="428 827 1370 945" style="background-color: #f0f0f0; padding: 5px;"> <p><b>Note:</b> This list appears only when you select one query node or two identical query nodes.</p> </div> <ul style="list-style-type: none"> <li>• <b>Allow All Relationships.</b> All relationships appear in the query results.</li> <li>• <b>Allow Self Relationships only.</b> Only self-relationships (a relationship that leads to itself) appear in the query results.</li> <li>• <b>Allow Non Self Relationships only.</b> Self-relationships do not appear in the query results.</li> </ul>

## Add Related Query Node Wizard

This wizard enables you to build a TQL query.

<b>To access</b>	<p>To access in Enrichment Manager, Impact Analysis Manager, and the Modeling Studio: In the editing pane, right-click the required query node and select <b>Add Related Query Node</b>.</p> <div data-bbox="407 1591 1370 1709" style="background-color: #f0f0f0; padding: 5px;"> <p><b>Note:</b> If you are using Enrichment Manager, select <b>Query</b> mode at the top of the editing pane to display the Add Related Query Node option.</p> </div> <p>To access in Universal Discovery in DFM:</p> <ol style="list-style-type: none"> <li>1. Select a job in the Discovery Modules pane.</li> </ol>
------------------	---



	<p>2. Select a Trigger Query in the Properties tab. Click the <b>Open the Query Editor</b>  button to open the <b>Trigger Query Editor</b>.</p> <p>3. Right-click the required query node and select <b>Add Related Query Node Wizard</b>.</p> <p>To access in Adapter Management in DFM:</p> <p>1. Select an adapter in the Resources pane.</p> <p>2. In the <b>Adapter Definition</b> tab, click the <b>Edit Input Query</b>  button to the right of the <b>Input Query</b> box to open the Input Query Editor.</p> <p>3. Right-click the required query node and select <b>Add Related Query Node Wizard</b>.</p>
<b>Important information</b>	If the TQL query is empty, drag the required TQL query nodes on to the editing pane from the tree displayed in the CI Type Selector or the CI Types tab of the left pane.
<b>Relevant tasks</b>	<ul style="list-style-type: none"> <li>• <a href="#">"How to Define an Impact Rule – Workflow" on page 467</a></li> <li>• <a href="#">"How to Define an Enrichment Rule – Scenario" on page 531</a></li> <li>• <a href="#">"How to Define a TQL Query" on page 24</a></li> <li>• "Implement a Discovery Adapter" in the <i>HP Universal CMDB Developer Reference Guide</i></li> <li>• <a href="#">"How to Create a Pattern View" on page 271</a></li> <li>• <a href="#">"How to Create a Template" on page 273</a></li> <li>• <a href="#">"How to Create a Perspective" on page 274</a></li> </ul>
<b>Wizard map</b>	<p>The Add Related Query Node Wizard contains:</p> <p><a href="#">"Related Query Node Type Page"</a> &gt; <a href="#">"Relationship Type Page"</a> &gt; <a href="#">"Related Query Node Properties Page"</a> &gt; <a href="#">"Related Query Node Instances Page"</a></p>
<b>See also</b>	<a href="#">"Topology Query Language (TQL) Overview" on page 14</a>



## Related Query Node Type Page

This wizard page enables you to add a query node to the TQL query.

<b>Important information</b>	<p>If the TQL query is empty, drag the required TQL query node on to the editing pane from the tree displayed in the Configuration Item Types pane.</p> <p>For general information on the Add Related Query Node Wizard, see <a href="#">"Add Related</a></p>
------------------------------	---

	<a href="#">Query Node Wizard</a> on the previous page.
<b>Wizard map</b>	The <a href="#">"Add Related Query Node Wizard"</a> contains:  <a href="#">"Related Query Node Type Page"</a> > <a href="#">"Relationship Type Page"</a> > <a href="#">"Related Query Node Properties Page"</a> > <a href="#">"Related Query Node Instances Page"</a>

User interface elements are described below (unlabeled elements are shown in angle brackets):

<b>UI Element (A-Z)</b>	<b>Description</b>
	<b>Expand All.</b> Expands all the folders in the tree.
	<b>Collapse All.</b> Collapses all the folders in the tree.
<b>Tree View</b> 	<b>Tree View.</b> Enables you to select the display format of the CI type tree. The following options are available: <ul style="list-style-type: none"> <li>• by Display label</li> <li>• by Class name</li> <li>• by Legacy class name</li> </ul> <p><b>Note:</b> This feature is only available in the Modeling Studio.</p>
<b>&lt;query node&gt; is required</b>	Define the relationship cardinality. For details, see <a href="#">"Query Node/Relationship Properties Dialog Box"</a> on page 73. <ul style="list-style-type: none"> <li>• Select the <b>&lt;query node&gt; is required</b> check box for each query node to include a minimum of one instance of the query node at the other end of the relationship in the query results. Selecting the check box gives the relationship a cardinality value of 1..*.</li> <li>• Clear the <b>&lt;query node&gt; is required</b> check box to give the relationship a cardinality value of 0..*.</li> </ul>
<b>&lt;TQL Query Node hierarchy tree&gt;</b>	Select the required query node. The query node you select appears in the <b>Element name</b> box.  This list only includes the query nodes of the CI type that have valid relationships to the selected (source) query node.  To the right of each query node, the number of CI instances that exist in the CMDB for that CI type is displayed. The number of instances is only updated after you close the

<b>UI Element (A-Z)</b>	<b>Description</b>
	Add Related Query Node Wizard and open it again.  <div style="background-color: #f0f0f0; padding: 5px;"><b>Note:</b> The first query node in the hierarchy tree is selected by default.</div>
<b>Element name</b>	(Optional) Contains the name of the selected query node. By default, the CI type is assigned as the element's name.  You can rename a TQL query node in the <b>Element name</b> box giving it a unique label. This can be helpful when there is more than one query node of the same CI type in the TQL query.
<b>Show only CITs with instances</b>	Select this check box to display only the CITs of which there are instances in the CMDB. If this box is not selected, the tree includes all CITs with a valid link to the source query node.  <div style="background-color: #f0f0f0; padding: 5px;"><b>Note:</b> The <b>Show only CITs with instances</b> check box is selected by default.</div>

## Relationship Type Page

This wizard page enables you to add a relationship to a TQL query.

<b>Wizard map</b>	The "Add Related Query Node Wizard" contains:  "Related Query Node Type Page" > " <b>Relationship Type Page</b> " > "Related Query Node Properties Page" > "Related Query Node Instances Page"
-------------------	--

User interface elements are described below (unlabeled elements are shown in angle brackets>):

<b>UI Element (A-Z)</b>	<b>Description</b>
<b>Tree View</b> 	<p><b>Tree View.</b> Enables you to select the display format of the Relationship tree. The following options are available:</p> <ul style="list-style-type: none"> <li>• by Display label</li> <li>• by Class name</li> <li>• by Legacy class name</li> </ul>

UI Element (A-Z)	Description
	<p><b>Note:</b> This feature is only available in the Modeling Studio.</p>
<b>&lt;TQL Query Relationship hierarchy tree&gt;</b>	Select the required relationship.
<b>Relationship Direction</b>	Select the required relationship direction. The direction indicates which query node is dependent on the other.
<b>Relationship Name</b>	<p>The name of the relationship.</p> <p><b>Note:</b> This feature is only available in the Modeling Studio.</p>
<b>Relationship Restrictions</b>	<p>Select an option to define how to handle relationships between identical query nodes or self relationships in the query results. A self relationship is a relationship that leads from a query node to itself.</p> <p><b>Note:</b> This feature is only available in the Modeling Studio.</p>
<b>Relationship Type</b>	<p>A valid relationship that defines the connection between the selected query nodes. The box displays the relationship you selected in the relationship hierarchy tree.</p> <p><b>Note:</b> This feature is only available in Enrichment Manager and Impact Analysis Manager.</p>
<b>Show only relationships with instances</b>	Display only the relationships of which there are instances in the CMDB. If this box is not selected, the tree includes all valid relationships between the selected query nodes.







## Related Query Node Properties Page

This wizard page enables you to create an expression that restricts the number of query nodes that appear in the query by adding an attribute condition to a query node or relationship.

<b>Important information</b>	<p>Each row represents an attribute condition that you specify. Use the And/Or column and the Brackets columns to link multiple conditions. In this way, you can construct a more precise logical statement to generate the required results.</p> <p>When you access the wizard from the Modeling Studio, this wizard page has three tabs:</p>
------------------------------	--

	<p><b>Attribute, Element Type, and Element Layout.</b> The <b>Attribute</b> tab includes the elements described below. For details on the <b>Element Type</b> tab, see "<a href="#">Element Type Tab</a>" on page 81. For details on the <b>Element Layout</b> tab, see "<a href="#">Element Layout Tab</a>" on page 83.</p>
<b>Wizard map</b>	<p>The "<a href="#">Add Related Query Node Wizard</a>" contains:</p> <p>"<a href="#">Related Query Node Type Page</a>" &gt; "<a href="#">Relationship Type Page</a>" &gt; "<b>Related Query Node Properties Page</b>" &gt; "<a href="#">Related Query Node Instances Page</a>"</p>

User interface elements are described below:

<b>UI Element (A-Z)</b>	<b>Description</b>
	<b>Add.</b> Adds an attribute condition row. Select the attribute name, operator, and value to define the attribute condition.
	<b>Delete.</b> Deletes the selected attribute condition.
	<b>Up.</b> Moves a selected row up.
	<b>Down.</b> Moves a selected row down.
	<b>Show Criteria.</b> Displays the criteria of the selected condition in a pop-up dialog box.
<b>And/Or</b>	Click inside the <b>And/Or</b> field and select either <b>And</b> or <b>Or</b> to link multiple conditions.
<b>Attribute name</b>	Choose an attribute from the list.
<b>Brackets</b> 	Click inside the <b>Brackets</b> box to display a list of brackets you can use to build more complex, logical statements.
<b>Criteria</b>	Contains the attribute condition definition as defined in the CI Instances Dialog Box.
<b>Include subtypes</b>	Display both the selected CI and its children in the topology map.  <b>Note:</b> This check box is only available in the Enrichment Manager and Impact Analysis Manager.
<b>NOT</b>	Select <b>NOT</b> if you want the condition statement to do the opposite of what is defined.  <b>Note:</b> If you select <b>NOT</b> , query results do not include data from the CI instances that

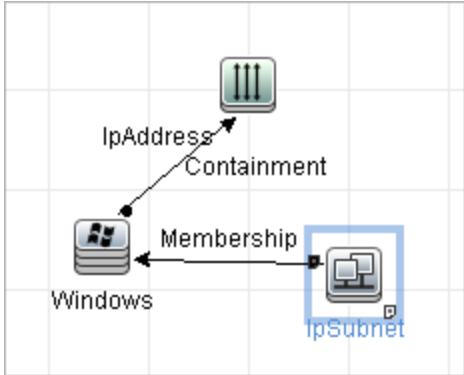
UI Element (A-Z)	Description
	<p>were not assigned a value. For example, your system contains three nodes: Node1 is assigned the value A, Node2 is assigned the value B and Node3 is not assigned a value. You create a query to retrieve all nodes that are equal to A and select <b>NOT</b>; the results of your query only include Node2 because Node3 is not assigned a value.</p>
<b>Operator</b>	<p>Select the required operator. For details, see <a href="#">"Attribute Operator Definitions"</a> on page 40.</p>
<b>Show element in query results</b>	<p>Select <b>Show element in query results</b> to display the selected TQL query node in the editing pane. When the check box is cleared, a <b>Hidden in Query Results</b> indicator <input type="checkbox"/> appears to the right of the selected TQL query node in the editing pane.</p>  <p>Any query results pertaining to that TQL query node are not displayed in the topology map. This can be useful when certain relationships or TQL query nodes are required to build the query but are not needed in the results. For example, Windows are connected to the network by defining specific IP Addresses, but in any query results you may want to view the IP Address elements only and not the Windows elements.</p>
<b>Value</b>	<p>Enter or select the value of the attribute. The <b>Value</b> options vary according to the attribute type you select.</p>

## Related Query Node Instances Page



This wizard page displays all the instances found for the selected TQL query node in a table.

<b>Important information</b>	<p>The columns displayed in the report vary according to the CI type selected.</p> <p>By default, only columns corresponding to attributes that have been defined with the <b>Asset Data</b>, <b>Managed</b>, and <b>Comparable</b> attribute qualifiers in the CI Type Manager are displayed as columns in the dialog box. For details, see <a href="#">"Attributes Page"</a> on page 508.</p>
------------------------------	---

	<p>If required, you can click the <b>Display Hidden Columns</b> button to display the attributes that are defined as Visible but not Static. For details on Static attributes, see <a href="#">"Attributes Page" on page 508</a>.</p> <p><b>Note:</b> For information on the elements included in the Related Query Node Instances page, see <a href="#">"CI Instances Dialog Box" on page 66</a>.</p>
<b>Wizard map</b>	<p>The <a href="#">"Add Related Query Node Wizard"</a> contains:</p> <p><a href="#">"Related Query Node Type Page"</a> &gt; <a href="#">"Relationship Type Page"</a> &gt; <a href="#">"Related Query Node Properties Page"</a> &gt; <b><a href="#">"Related Query Node Instances Page"</a></b></p>

## Add Triplet Dialog Box

This dialog box enables you to define the allowed steps in a path in the topology graph leading from the source CI to the target CI when creating a subgraph definition, a compound relationship, or a calculated relationship.

<b>To access</b>	<p>In Enrichment Manager, Impact Analysis Manager, or the Input Query Editor in DFM:</p> <ul style="list-style-type: none"> <li>In the Add Compound Relationship dialog box, click the <b>Add</b>  button. For details, see <a href="#">"Add/Edit Compound Relationship Dialog Box" on page 48</a>.</li> <li>In the Subgraph Definition dialog box, click <b>Add</b> . For details, see <a href="#">"Subgraph Definition Dialog Box" on page 91</a>.</li> </ul> <p>In CI Type Manager, select <b>Calculated Relationships</b> from the drop-down list in the CI Types pane. In the editing pane, select the <b>Triplets</b> page and then click <b>Add</b> .</p>
<b>Important information</b>	<p>Select the query nodes and relationships to be included in the topology graph.</p> <p><b>Note:</b> The Condition fields are displayed only when you access the Add Triplet dialog box from the Subgraph Definition dialog box.</p>
<b>Relevant tasks</b>	<ul style="list-style-type: none"> <li><a href="#">"How to Define an Impact Rule – Workflow" on page 467</a></li> <li><a href="#">"How to Define an Enrichment Rule – Scenario" on page 531</a></li> <li><a href="#">"How to Define a TQL Query" on page 24</a></li> <li>"Implement a Discovery Adapter" in the <i>HP Universal CMDB Developer Reference Guide</i></li> </ul>

	<ul style="list-style-type: none"> <li>• <a href="#">"How to Create a Pattern View" on page 271</a></li> <li>• <a href="#">"How to Create a Template" on page 273</a></li> <li>• <a href="#">"How to Create a Perspective" on page 274</a></li> </ul>
<b>See also</b>	<ul style="list-style-type: none"> <li>• <a href="#">"Compound Relationship" on page 18</a></li> <li>• <a href="#">"How to Define a Compound Relationship – Scenario" on page 27</a></li> <li>• <a href="#">"Subgraph Definition" on page 22</a></li> </ul>

User interface elements are described below:

<b>UI Element (A-Z)</b>	<b>Description</b>
	<p><b>Condition.</b> Enables you to define attribute conditions for the source and target query nodes you selected. When the Add Triplet dialog box is opened from the Subgraph Definition dialog box, it opens the Subgraph Condition Definition dialog box. When the Add Triplet dialog box is opened from the Add Compound Relationship dialog box, it opens the Compound Relationship Condition Definition dialog box.</p> <p>The <b>Condition</b> button is enabled only after you select a query node from the <b>Source</b> or <b>Target</b> lists.</p> <p><b>Note:</b> You cannot define attribute conditions for the source and target query nodes in the CI Type Manager.</p>
<b>Relationship</b>	Select an available relationship connecting the two query nodes. The list of available relationships appears only after defining both query nodes.
<b>Relationship Direction</b>	Select the required direction. Setting different relationship directions can achieve different query results. For an example, see <a href="#">"Setting Different Relationship Directions for Compound Definitions" on the next page</a> .
<b>Source</b>	Select the required source query node.
<b>Target</b>	Select the required target query node.



### Setting Different Relationship Directions for Compound Definitions

You can achieve different TQL results by setting different relationship directions. For example, in your business world, as illustrated below, you want to create a compound relationship that connects between a query node of the CIT **a** and a query node of the CIT **b**. Depth is defined at 5 (for details, see "[Depth](#)" on page 92).

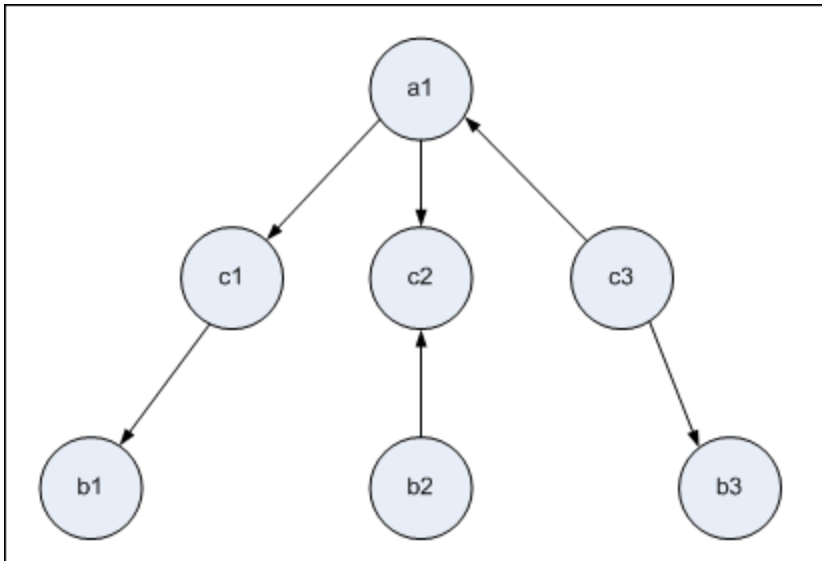

In the Add Triplet dialog box, you can create compound definitions to link query nodes **a** and **b** using different relationship directions.

Compound Definition	Source	Target	Relationship	Relationship Direction
#1	query node <b>a</b>	query node <b>c</b>	<relationship>	source --> target
#2	query node <b>c</b>	query node <b>b</b>	<relationship>	source --> target
#3	query node <b>c</b>	query node <b>b</b>	<relationship>	source <-- target

- Compound definitions 1 and 2 result in the following query:

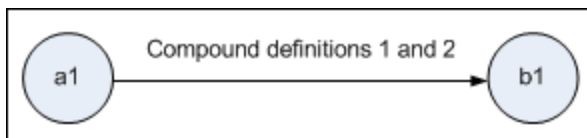

- Compound definitions 1 and 3 result in the following query:

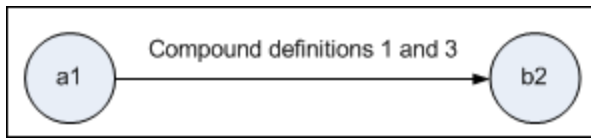

- Compound definitions 1, 2, and 3 result in the following query:

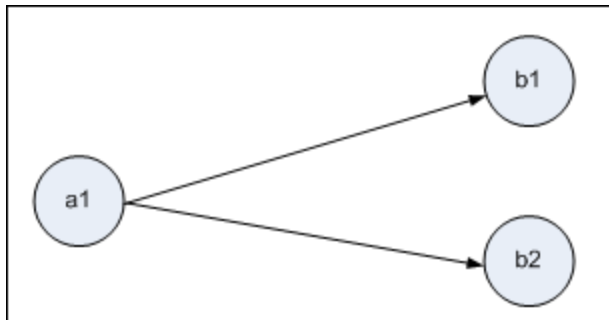







## CI Instances Dialog Box





This dialog box displays all of the CI instances found for the selected TQL query node.



<b>To access</b>	<p><b>To access in Enrichment Manager, Impact Analysis Manager, and the Modeling Studio:</b></p> <p>In the editing pane, right-click the required query node and select Show Element Instances.</p> <div style="background-color: #f0f0f0; padding: 5px; margin: 10px 0;"> <p><b>Note:</b> If you are using Enrichment Manager, select <b>Query</b> mode at the top of the editing pane to display the Show Element Instances option.</p> </div> <p><b>To access in Adapter Management in DFM:</b></p> <ol style="list-style-type: none"> <li>1. Select an adapter in the Resources pane.</li> <li>2. In the <b>Adapter Definition</b> tab, click the <b>Edit Input Query</b>  button to the right of the <b>Input Query</b> box to open the Input Query Editor.</li> <li>3. Right-click the required query node and select <b>Show Element's Instances</b>.</li> </ol> <p><b>To access in Integration Studio:</b></p> <p>Create an integration point based on a Jython integration adapter. On the Trigger CI Instance menu, choose <b>Select Existing CI</b>.</p>
<b>Important</b>	The columns in the table display the attributes of the selected CI type. The attributes

<b>information</b>	<p>displayed vary according to the CI type selected.</p> <p>By default, only columns corresponding to attributes that have been defined with the <b>Asset Data</b>, <b>Managed</b>, and <b>Comparable</b> attribute qualifiers in the CIT Manager are displayed as columns in the dialog box. For details, see <a href="#">"Attributes Page" on page 508</a>.</p>
<b>Relevant tasks</b>	<p><a href="#">"How to Define an Impact Rule – Workflow" on page 467</a></p> <p><a href="#">"How to Define an Enrichment Rule – Scenario" on page 531</a></p> <p><a href="#">"How to Define a TQL Query" on page 24</a></p> <p><a href="#">"How to Create a Pattern View" on page 271</a></p> <p><a href="#">"How to Create a Template" on page 273</a></p> <p><a href="#">"How to Create a Perspective" on page 274</a></p> <p>"Work with Population Jobs" in the <i>HP Universal CMDB Data Flow Management Guide</i></p> <p>"Work with Data Push Jobs" in the <i>HP Universal CMDB Data Flow Management Guide</i></p>
<b>See also</b>	<ul style="list-style-type: none"> <li>• <a href="#">"Topology Query Language (TQL) Overview" on page 14</a></li> <li>• <a href="#">"Topology Query Language User Interface" on page 45</a></li> </ul>

User interface elements are described below (unlabeled elements are shown in angle brackets>):

UI Element (A-Z)	Description
	Specify the CIT you want displayed in the table. The table also includes the children of the selected CIT.
	<b>Delete from CMDB.</b> Deletes the selected CI.
	<b>Properties.</b> Opens the Configuration Item Properties dialog box for the selected CI.
	<b>Refresh.</b> Refreshes the list of CI instances.
	<b>Set Filter.</b> Filters the CI instances you want to display for the selected query node. Opens the Filter CI Instances dialog box.
	<b>Clear Filter.</b> Clears the filter definitions you created in the Filter CI Instances dialog box.
	<b>Select Columns.</b> Enables you to select the columns to be displayed. For details, see <a href="#">"Select Columns Dialog Box" on page 571</a> .

UI Element (A-Z)	Description
	<p><b>Sort Column Content.</b> Enables you to set the sort order of the CI instances. For details, see <a href="#">"Sort Column Content Dialog Box" on page 572.</a></p>
	<p><b>Find.</b> Displays the Find toolbar.</p>
	<p><b>Send Mail.</b> Enables you to send the table data in an email.</p>
	<p><b>Export Data To File.</b> Enables you to select the format for previewing and exporting the table data. The available options are:</p> <ul style="list-style-type: none"> <li>• <b>Excel.</b> The table data is formatted as an .xls (Excel) file that can be displayed in a spreadsheet.</li> <li>• <b>PDF.</b> The table data is exported in PDF format.</li> </ul> <div style="background-color: #f0f0f0; padding: 10px; margin: 10px 0;"> <p><b>Note:</b> When exporting to PDF, select a reasonable number of columns to display to ensure that the report is legible.</p> </div> <ul style="list-style-type: none"> <li>• <b>CSV.</b> The table data is formatted as a comma-separated values (CSV) text file that can be displayed in a spreadsheet.</li> </ul> <div style="background-color: #f0f0f0; padding: 10px; margin: 10px 0;"> <p><b>Note:</b> For the CSV formatted table data to display correctly, the comma (,) must be defined as the list separator. In Windows, to verify or modify the list separator value, open Regional Options from the Control Panel, and on the Numbers tab ensure that the comma is defined as the List Separator value. In Linux, you can specify the list separator in the application that opens the CSV file.</p> </div> <ul style="list-style-type: none"> <li>• <b>XML.</b> The table data is formatted as an XML file that can be opened in a text or XML editor.</li> </ul> <div style="background-color: #f0f0f0; padding: 10px; margin: 10px 0;"> <p><b>Tip:</b> To extract HTML code from the report:</p> <ul style="list-style-type: none"> <li>• Open the file in an HTML editor</li> <li>• Copy the relevant table into the target file</li> </ul> </div>

UI Element (A-Z)	Description
 Rows per page	Select the number of rows to be displayed on each page. You can also manually enter value for the number of rows per page.
	Click to navigate through the results page by page or to jump to the first or last page.
<CI Instances>	The CI instances found for the selected TQL query node. You can double-click an instance to open the Configuration Item Properties dialog box for that CI.
<CI instances shortcut menu>	For details, see <a href="#">"IT Universe Manager Shortcut Menu" on page 235.</a>
Display Label	The name of the CI instance as it appears in the topology map.

## Conditions Preview Dialog Box

This dialog box displays the conditions selected when selecting a complex type condition in the Element Type tab of the Query Node Properties dialog box.

<b>To access</b>	Click the <b>Preview</b>  button from the Element Type tab of the Query Node Properties dialog box.
<b>See also</b>	<a href="#">"Query Node Conditions" on page 19</a>

User interface elements are described below:

UI Element (A-Z)	Description
<b>CI Type</b>	Displays the subtypes for which you defined conditions.
<b>Condition</b>	Displays the icon of the selected condition, as defined in the Legend.
<b>Filter by</b>	Specifies the selected condition (i.e., by CI type or by qualifier, and for qualifier, specifies the qualifiers).

## Element Layout Preview Dialog Box

This dialog box displays the attributes selected in the Element Layout tab of the Query Node Properties dialog box to be included in the query results for the selected element.

<b>To access</b>	Click the <b>Preview</b>  button from the Element Layout tab of the Query Node
------------------	---



	Properties dialog box.
<b>See also</b>	<a href="#">"Query Node Conditions" on page 19</a>

User interface elements are described below:

UI Element (A-Z)	Description
<b>Attributes Mode</b>	Displays the Attributes condition selected in the Element Layout tab of the Query Node Properties dialog box.
<b>CI Type</b>	Displays the CIT of the selected query node or relationship.
<b>Excluded Attributes</b>	Displays the attributes appearing in the Excluded Attributes pane in the Element Layout tab of the Query Node Properties dialog box.
<b>Qualifier Marked Attributes</b>	Displays the qualifiers selected in the Element Layout tab of the Query Node Properties dialog box.
<b>Specific Attributes</b>	Displays the attributes appearing in the Specific Attributes pane in the Element Layout tab of the Query Node Properties dialog box.

## Filter CI Instances Dialog Box

This dialog box enables you to reduce the number of CI instances to be displayed in a list by selecting a condition and a value for a specific CI.

<b>To access</b>	Click the <b>Filter</b>  button in the CI Instances dialog box.
<b>Important information</b>	<p>A description of the filter condition you defined appears above the table columns in the CI Instances dialog box. For example, the following illustration shows that a filter condition was created to display only CI instances whose CI type is <b>Windows</b>.</p> 
<b>Relevant tasks</b>	<ul style="list-style-type: none"> <li>• <a href="#">"How to Define an Impact Rule – Workflow" on page 467</a></li> <li>• <a href="#">"How to Define an Enrichment Rule – Scenario" on page 531</a></li> <li>• <a href="#">"How to Define a TQL Query" on page 24</a></li> <li>• "Implement a Discovery Adapter" in the <i>HP Universal CMDB Developer Reference Guide</i></li> </ul>

	<ul style="list-style-type: none"> <li>• <a href="#">"How to Create a Pattern View" on page 271</a></li> <li>• <a href="#">"How to Create a Template" on page 273</a></li> <li>• <a href="#">"How to Create a Perspective" on page 274</a></li> </ul>
--	---

User interface elements are described below:

UI Element (A-Z)	Description
<b>Attribute</b>	Displays all the attributes of the CI type to which the CI belongs.
<b>Condition</b>	Select the required operator. For details, see <a href="#">"Attribute Operator Definitions" on page 40.</a>
<b>NOT</b>	Select to filter the results by the negation of a condition and value.
<b>Value</b>	Select or enter the required value.

## Join Relationship Condition Dialog Box

This dialog box enables you to define the connection between two query nodes using a join relationship.

<b>To access</b>	In Enrichment Manager or Impact Analysis Manager, click the <b>Add</b>  button in the Add Join Relationship dialog box.
<b>Important information</b>	You cannot select attributes of type list for a join relationship condition.
<b>Relevant tasks</b>	<ul style="list-style-type: none"> <li>• <a href="#">"How to Define an Impact Rule – Workflow" on page 467</a></li> <li>• <a href="#">"How to Define an Enrichment Rule – Scenario" on page 531</a></li> <li>• <a href="#">"How to Define a TQL Query" on page 24</a></li> <li>• "Implement a Discovery Adapter" in the <i>HP Universal CMDB Developer Reference Guide</i></li> </ul>

User interface elements are described below (unlabeled elements are shown in angle brackets>):

UI Element (A-Z)	Description
<b>&lt;Selected query node1&gt;</b>	A selected query node. The first attribute applies to <end_1>.
<b>&lt;Selected query node2&gt;</b>	A selected query node. The second attribute applies to <end_2>.
<b>Operator</b>	<p>Select one of the following operators:</p> <ul style="list-style-type: none"> <li>• <b>Equal.</b> The system checks whether two selected attributes are equal.</li> <li>• <b>Not equal.</b> The system checks whether two selected attributes are not equal.</li> <li>• <b>Sub string.</b> The system checks whether the value of the first attribute is a substring of the value of the second attribute.</li> <li>• <b>Sub string ignore case.</b> The system checks whether the value of the first attribute is a substring of the value of the second attribute regardless of the string's case.</li> </ul> <p><b>Note:</b> When using the operator <b>Not equal</b>, ensure that both sides of the join relationship have a limited result size. It is recommended to define more specific conditions so as not to overload the system with large results.</p>

## Layout Settings Dialog Box

This dialog box enables you to determine which attributes are used in the calculation of the TQL query when using the UCMDB API. For details, see HP Universal CMDB Web Service API in the *HP Universal CMDB Developer Reference Guide*.

<b>To access</b>	Click <b>Advanced layout settings</b> in the Query Node/Relationship Properties dialog box in Enrichment Manager or Impact Analysis Manager.
<b>Important information</b>	Since this option is only relevant when querying the CMDB API, the query results in the user interface are not impacted by the attributes you select in this dialog box.
<b>Relevant tasks</b>	<ul style="list-style-type: none"> <li>• <a href="#">"How to Define an Impact Rule – Workflow" on page 467</a></li> <li>• <a href="#">"How to Define an Enrichment Rule – Scenario" on page 531</a></li> <li>• <a href="#">"How to Define a TQL Query" on page 24</a></li> </ul>



	<ul style="list-style-type: none"> <li>• Implement a Discovery Adapter in the <i>HP Universal CMDB Developer Reference Guide</i></li> <li>• <a href="#">"How to Create a Pattern View" on page 271</a></li> <li>• <a href="#">"How to Create a Template" on page 273</a></li> <li>• <a href="#">"How to Create a Perspective" on page 274</a></li> </ul>
--	--

User interface elements are described below:

UI Element (A-Z)	Description
<b>Attribute name</b>	The name of the attribute.
<b>Calculate</b>	Select this check box to include the attribute in the query's calculation.

## Query Node/Relationship Properties Dialog Box

This dialog box enables you to define the attribute conditions for the selected TQL query node/relationship.

<b>To access</b>	<p>To access in Enrichment Manager, Impact Analysis Manager, and the Modeling Studio:</p> <p>In the editing pane, right-click the required query node and select <b>Query Node/Relationship Properties</b> or double-click the required query node or relationship.</p> <div style="background-color: #f0f0f0; padding: 5px; margin: 10px 0;"> <p><b>Note:</b> If you are using Enrichment Manager, select <b>Query</b> mode at the top of the editing pane to display the <b>Query Node Properties</b> option.</p> </div> <p>To access in DFM:</p> <ol style="list-style-type: none"> <li>1. To access from the Adapter Definition tab, select an adapter. Click the <b>Edit Input Query</b>  button to the right of the <b>Input Query</b> box to open the Input Query Editor.</li> <li>2. Right-click the required query node/relationship and select <b>Query Node Properties</b> or <b>Relationship Properties</b> or double-click the required query node or relationship.</li> </ol>
<b>Relevant tasks</b>	<ul style="list-style-type: none"> <li>• <a href="#">"How to Define an Impact Rule – Workflow" on page 467</a></li> <li>• <a href="#">"How to Define an Enrichment Rule – Scenario" on page 531</a></li> <li>• <a href="#">"How to Define a TQL Query" on page 24</a></li> <li>• Implement a Discovery Adapter in the <i>HP Universal CMDB Developer Reference Guide</i></li> </ul>

	<ul style="list-style-type: none"> <li>• <a href="#">"How to Create a Pattern View" on page 271</a></li> <li>• <a href="#">"How to Create a Template" on page 273</a></li> <li>• <a href="#">"How to Create a Perspective" on page 274</a></li> </ul>
--	---

User interface elements are described below:

<b>UI Element (A-Z)</b>	<b>Description</b>
<b>Element name</b>	(Optional) The <b>Element name</b> box contains the name of the selected query node/relationship. By default, the CI type is assigned as the element's name. You can rename a TQL query node in the <b>Element name</b> box giving it a unique label. This can be helpful when there is more than one query node of the same CI type in the TQL query.
<b>Element type</b>	<p>Displays the CI type of the selected query node. If you want to change the query node type to a child of the original type, select a subtype from the drop-down list.</p> <div data-bbox="370 934 1369 1178" style="background-color: #f0f0f0; padding: 10px;"> <p><b>Note:</b></p> <ul style="list-style-type: none"> <li>• If you have already defined a complex type condition for the query node, the condition is lost when you change the query node type.</li> <li>• This feature is only available in the Modeling Studio.</li> </ul> </div>
<b>Include subtypes</b>	<p>Select to display both the selected CI and its children in the topology map.</p> <div data-bbox="370 1262 1369 1381" style="background-color: #f0f0f0; padding: 10px;"> <p><b>Note:</b> This feature is only available in Enrichment Manager and Impact Analysis Manager.</p> </div>
<b>Query Result</b>	<p>Click <b>Query Result</b> to display a topology map of the TQL query showing the number of instances of each query node/relationship.</p> <div data-bbox="370 1503 1369 1583" style="background-color: #f0f0f0; padding: 10px;"> <p><b>Note:</b> This feature is only available in the Modeling Studio.</p> </div>
<b>Show element in query results</b>	<p>Select <b>Show element in query results</b> to display the selected TQL query node in the editing pane. When this option is cleared, a <b>Hidden in Query Results</b> indicator  appears to the right of the selected TQL query node in the editing pane.</p>

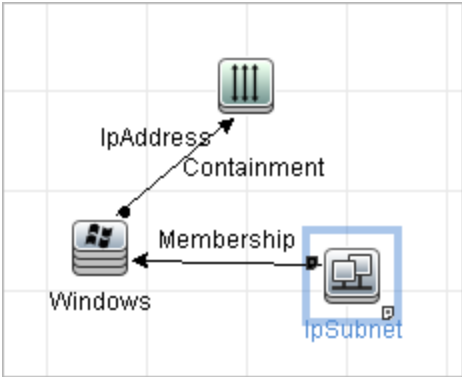
UI Element (A-Z)	Description
	 <p>Any query results pertaining to that TQL query node are not displayed in the topology map. This can be useful when certain relationships or TQL query nodes are required to build the query but are not needed in the results. For example, Windows are connected to the IP Subnet by defining specific IP Addresses, but in any query results you may want to view the IP Address elements only and not the Windows elements.</p>





### Attribute Tab

This tab enables you to create an expression defining conditions that restrict the number of query nodes that appear in the query. You can add an attribute condition to a query node or relationship and filter the query results.

<b>To access</b>	Click the <b>Attribute</b> tab in the Query Node/Relationship Properties dialog box.
<b>Important information</b>	<p>Each row represents an attribute condition that you specify. Use the And/Or column and the Brackets columns to link multiple conditions. In this way, you can construct a more precise logical statement to generate the required results.</p> <div style="background-color: #f0f0f0; padding: 10px; border: 1px solid #ccc;"> <p><b>Note:</b></p> <ul style="list-style-type: none"> <li>This tab is not available for calculated relationships.</li> <li>When you access the Query Node/Relationship Properties dialog box in Modeling Studio, this tab is read-only for Enrichment and Impact type queries for which an Enrichment rule or Impact rule is defined.</li> </ul> </div>
<b>Relevant tasks</b>	<ul style="list-style-type: none"> <li><a href="#">"How to Define an Impact Rule – Workflow" on page 467</a></li> </ul>

	<ul style="list-style-type: none"> <li>• <a href="#">"How to Define an Enrichment Rule – Scenario" on page 531</a></li> <li>• <a href="#">"How to Define a TQL Query" on page 24</a></li> <li>• Implement a Discovery Adapter in the <i>HP Universal CMDB Developer Reference Guide</i></li> <li>• <a href="#">"How to Create a Pattern View" on page 271</a></li> <li>• <a href="#">"How to Create a Template" on page 273</a></li> <li>• <a href="#">"How to Create a Perspective" on page 274</a></li> </ul>
--	---

User interface elements are described below:

UI Element (A-Z)	Description
	<b>Add.</b> Adds an attribute condition row. Select the attribute name, operator, and value to define the attribute condition.
	<b>Delete.</b> Deletes the selected attribute condition.
	<b>Up.</b> Moves the selected row up.
	<b>Down.</b> Moves the selected row down.
	<b>Show Criteria.</b> Displays the criteria of the selected condition in a pop-up dialog box.
<b>Advanced layout settings</b>	<p>Opens the Layout Settings dialog box which enables you to determine which attributes are used in the calculation of the TQL query when querying the CMDB using third-party or custom tools.</p> <p><b>Note:</b> This feature appears only in Enrichment Manager and Impact Analysis Manager.</p>
<b>And/Or</b>	Click inside the <b>And/Or</b> field and select either <b>And</b> or <b>Or</b> to link multiple conditions.
<b>Attribute name</b>	<p>Select an attribute from the drop-down list.</p> <p><b>Note:</b> When you select one of the following attribute types: float, double, or long, the <b>In</b> operator is not available.</p>
<b>Brackets</b>	Click inside the <b>Brackets</b> box to display a list of brackets you can use to build more

UI Element (A-Z)	Description
	complex, logical statements.
<b>Criteria</b>	Contains the attribute condition definition as defined in the CI Instances dialog box.
<b>Default Value</b>	For parameterized attributes, enter a default value for the parameter.
<b>Not</b>	<p>Select <b>NOT</b> if you want the condition statement to do the opposite of what is defined.</p> <p><b>Note:</b> If you select <b>NOT</b>, query results do not include data from the CI instances that were not assigned a value. For example, your system contains three nodes: Node1 is assigned the value A, Node2 is assigned the value B and Node3 is not assigned a value. You create a query to retrieve all nodes that are equal to A and select <b>NOT</b>; the results of your query only include Node2 because Node3 is not assigned a value.</p>
<b>Operator</b>	<p>Select the required operator. For details, see "<a href="#">Attribute Operator Definitions</a>" on page 40.</p> <p><b>Note:</b> When you select one of the following attribute types: float, double, or long, the <b>In</b> operator is not available.</p>
<b>Parameterized</b>	<p>Select <b>Yes</b> to define a parameterized value for the attribute. Select <b>No</b> to define a fixed value for the attribute.</p> <p><b>Note:</b> This feature is only available in the Modeling Studio.</p>
<b>Parameter Name</b>	<p>If you are defining a parameterized value for the attribute, you must enter the parameter name.</p> <p><b>Note:</b> This feature is only available in the Modeling Studio.</p>
<b>Value</b>	<p>Enter or select the value of the attribute. The <b>Value</b> options vary according to the attribute type you select.</p> <p><b>Note:</b> You can paste a copied value into the window by pressing <b>CTRL+v</b> on the keyboard.</p>







## Cardinality Tab

In this area, you can define a relationship cardinality, which enables you to define how many CI instances you expect to have at the end of a relationship in your query result.

<b>To access</b>	Click the <b>Cardinality</b> tab in the Query Node Properties dialog box.
<b>Important information</b>	<p>Select the required relationship to which the selected query node is attached. Then define the lower and upper limits for including the query node at the other end of the relationship in the query results.</p> <p>Each row represents a cardinality condition that you specify. Use the And/Or column and the Brackets columns to link multiple conditions.</p> <p>You can define relationship conditions that enable the relationship's connecting query node to be included in the TQL query results by creating an expression defining that condition. For an example, see <a href="#">"Example of a Relationship Condition" on page 80</a>.</p> <div style="background-color: #f0f0f0; padding: 10px; margin-top: 10px;"> <p><b>Note:</b></p> <ul style="list-style-type: none"> <li>This tab only appears when a query node is selected.</li> <li>When you access the Query Node/Relationship Properties dialog box in Modeling Studio, this tab is read-only for Enrichment and Impact type queries for which an Enrichment rule or Impact rule is defined.</li> </ul> </div>
<b>Relevant tasks</b>	<ul style="list-style-type: none"> <li><a href="#">"How to Define an Impact Rule – Workflow" on page 467</a></li> <li><a href="#">"How to Define an Enrichment Rule – Scenario" on page 531</a></li> <li><a href="#">"How to Define a TQL Query" on page 24</a></li> <li>Implement a Discovery Adapter in the <i>HP Universal CMDB Developer Reference Guide</i></li> <li><a href="#">"How to Create a Pattern View" on page 271</a></li> <li><a href="#">"How to Create a Template" on page 273</a></li> <li><a href="#">"How to Create a Perspective" on page 274</a></li> </ul>

User interface elements are described below:

<b>UI Element (A-Z)</b>	<b>Description</b>
	<b>Add.</b> Adds a cardinality condition row. Select the query node and max and

UI Element (A-Z)	Description
	min values to define the cardinality condition.
	<b>Delete.</b> Deletes a cardinality condition from the Cardinality area.
	<b>Up.</b> Moves a selected row up.
	<b>Down.</b> Moves a selected row down.
	<b>Show Criteria.</b> Displays the criteria in a pop-up dialog box.
	Inserts <b>1</b> in the Min box and <b>*</b> in the Max box.  <b>Note:</b> Only relevant for the Modeling Studio.
	Inserts <b>0</b> in the Min box and <b>*</b> in the Max box.  <b>Note:</b> Only relevant for the Modeling Studio.
<b>And/Or</b>	Click inside the <b>And/Or</b> field and select either <b>And</b> or <b>Or</b> to link multiple conditions.
<b>Brackets</b> 	Click inside the <b>Brackets</b> box to display a list of brackets you can use to build more complex, logical statements.
<b>Criteria</b>	Contains the cardinality condition definition as defined in the CI Instances Dialog Box.
<b>Max</b>	Enter the value that defines the upper limits for including the query node at the other end of the relationship in the query results.  <b>Note:</b> You can use an asterisk (*) in the <b>Max</b> box to represent an infinite value.
<b>Min</b>	Enter the value that defines the lower limits for including the query node at the other end of the relationship in the query results.  For example, if <end_1> is <b>IpAddress</b> and <end_2> is <b>Windows</b> , entering <b>1</b> in the <b>Min</b> box and asterisk (*) in the <b>Max</b> box instructs the system to retrieve only those IP Addresses that are connected to at least one Windows operating system. (The asterisk indicates an infinite value.) Entering <b>3</b> in the <b>Min</b> box and asterisk (*) in the <b>Max</b> box instructs the

UI Element (A-Z)	Description
	system to retrieve only those Windows operating systems that are connected to at least three IP Addresses.
<b>Query Node</b>	Select the required relationship to which the selected query node is attached. The list contains all the relationships that are linked to the selected query node.
<b>Not</b>	Select <b>NOT</b> if you want the condition statement to do the opposite of what is defined.  <div style="border: 1px solid gray; padding: 5px;"> <p><b>Note:</b> If you select <b>NOT</b>, query results do not include data from the CI instances that were not assigned a value. For example, your system contains three nodes: Node1 is assigned the value A, Node2 is assigned the value B and Node3 is not assigned a value. You create a query to retrieve all nodes that are equal to A and select <b>NOT</b>; the results of your query only include Node2 because Node3 is not assigned a value.</p> </div>

**Example of a Relationship Condition**

The example of relationship conditions is based on the following TQL query:

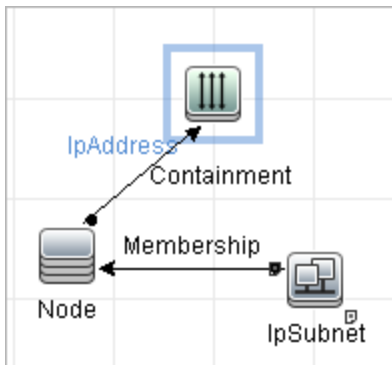

In the Relationship Cardinality dialog box, the following relationship conditions are defined for the query:

- Containment – **Min: 2, Max: 4**
- Membership – **Min: 1, Max: \***

Using the OR operator, the definitions appear in the **Cardinality** section, as follows:

NOT	(	Criteria	)	And/Or
<input type="checkbox"/>		Containment (Node, IpAddress) : 2..4		OR
<input type="checkbox"/>		Membership (IpSubnet, Node) : 1..*		



- [Containment (Node, IP Address)] OR [Membership (IP Subnet, Node)] means that the node must either have between two and four IP Addresses OR be a member of the IP Subnet.

Using the AND operator, the definitions appear in the **Cardinality** section, as follows:

NOT	(	Criteria	)	And/Or
<input type="checkbox"/>		Containment (Node, IpAddress) : 2..4		AND
<input type="checkbox"/>		Membership (IpSubnet, Node) : 1..*		

- [Containment (Node, IP Address)] AND [Membership (IP Subnet, Node)] means that the node must have between two and four IP Addresses AND also be a member of the IP Subnet.

**Note:** A cardinality of (0..0) is only valid when both ends of a relationship are defined with that cardinality. If one end is defined with cardinality (0..0) and the other end is defined with a different cardinality, the condition is invalid. However, the TQL query is saved (the cardinality has no effect on the query results).





## Element Type Tab

This area enables you to specify subtype conditions for the selected query node or relationship.

<b>To access</b>	Click the <b>Element Type</b> tab in the Query Node/Relationship Properties dialog box.
<b>Important information</b>	This tab is only available in the Modeling Studio. This tab is not available for calculated relationships.
<b>Relevant tasks</b>	<ul style="list-style-type: none"> <li>• <a href="#">"How to Define a TQL Query" on page 24</a></li> <li>• <a href="#">"How to Create a Pattern View" on page 271</a></li> <li>• <a href="#">"How to Create a Template" on page 273</a></li> <li>• <a href="#">"How to Create a Perspective" on page 274</a></li> <li>• <a href="#">"How to Define a Complex Type Condition - Scenario" on page 32</a></li> </ul>

User interface elements are described below (unlabeled elements are shown in angle brackets):

UI Element (A-Z)	Description
<Legend>	Indicates the icons displayed next to the subtypes based on the selected

UI Element (A-Z)	Description
	conditions: <ul style="list-style-type: none"> <li> Include the subtype without its descendants.</li> <li> Include the subtype with its descendants.</li> <li> Exclude the subtype without its descendants.</li> <li> Exclude the subtype with its descendants.</li> </ul>
<b>CI Types/Relationships pane</b>	When Customize subtypes is selected, the CI Types pane displays a tree with all subtypes of the selected CI type (for relationships, the Relationships pane displays a tree with all subtypes of the selected relationship). After selecting conditions in Conditions pane, click the <b>Preview</b>  button to open the Conditions Preview dialog box.
<b>Conditions pane</b>	For details, see <a href="#">"Conditions Pane" below</a> .
<b>Customize subtypes</b>	Select Customize subtypes to set a complex type condition. Select the required subtypes from the tree in the CI Types/Relationships pane and select conditions for them in the Conditions pane, as described below.
<b>Element type</b>	Select <b>Element type</b> to set a simple type condition. If you want to include all subtypes of the selected CI type, select the <b>Include subtypes</b> check box. If you do not want to include all subtypes, clear the check box.

**Conditions Pane**

UI Element (A-Z)	Description
<b>Apply this condition recursively on all subtypes of &lt;selected CI type&gt;</b>	Select this check box to apply the specified condition for the selected CI type to all of that CI type's descendants, recursively.
<b>By CI types</b>	Select <b>By CI types</b> to include or exclude all instances of the selected CI type in the query results.
<b>By qualifiers</b>	Select <b>By qualifiers</b> to include or exclude instances of the selected CI type with specific qualifiers in the query results. A pop-up window appears with a list of qualifiers. Select the required qualifiers for the selected subtype. For details on the qualifiers, see <a href="#">"Qualifier Tab" on page 85</a> .
<b>Condition</b>	Select a condition for the selected CI type. The following options are

UI Element (A-Z)	Description
	<p>available:</p> <ul style="list-style-type: none"> <li>• <b>None.</b> No condition is selected for this CI type. Instances of this CI type and all its descendants are included in the query results, unless a parent CI type of this CI type was selected for exclusion and the Apply recursively check box was selected.</li> <li>• <b>Include &lt;selected subtype&gt; in the query.</b> Includes instances of the selected CI type in the query results (according to the condition selected). An example of a situation where this option is relevant is where a parent of the CI type was selected to be excluded and the Apply recursively check box was selected. You can select certain subtypes to be included, so the query results exclude all subtypes of the parent CI type except for the specified ones.</li> <li>• <b>Exclude &lt;selected subtype&gt; from the query.</b> Excludes instances of the selected CI type from the query results (according to the condition selected).</li> </ul>



### Element Layout Tab

This area enables you to select the attribute values returned in the query results for the selected query node or relationship.

<b>To access</b>	Click the <b>Element Layout</b> tab in the Query Node/Relationship Properties dialog box.
<b>Important information</b>	<p>When you make a selection of the attributes to include in the query results for a particular CIT, the selection also applies to all of its descendant CITs. You can manually exclude specific attributes for descendant CITs in the Conditions pane.</p> <p>This option is only relevant when querying the CMDB API. The query results in the user interface are not impacted by the attributes you select in this dialog box.</p> <p>This tab is only available in the Modeling Studio.</p> <p>This tab is not available for calculated relationships.</p>
<b>Relevant tasks</b>	<ul style="list-style-type: none"> <li>• <a href="#">"How to Define a TQL Query" on page 24</a></li> <li>• <a href="#">"How to Create a Pattern View" on page 271</a></li> <li>• <a href="#">"How to Create a Template" on page 273</a></li> </ul>

	<ul style="list-style-type: none"> <li>• <a href="#">"How to Create a Perspective" on page 274</a></li> <li>• <a href="#">"How to Define a Complex Type Condition - Scenario" on page 32</a></li> </ul>
--	---

User interface elements are described below (unlabeled elements are shown in angle brackets):

UI Element (A-Z)	Description
<Legend>	Indicates the icons displayed next to the subtypes based on the selected attributes condition: <ul style="list-style-type: none"> <li>•  Include all attributes for this subtype.</li> <li>•  Include only the selected attributes for this subtype.</li> </ul>
CI Types/Relationships pane	When <b>Select attributes for layout</b> is selected, the CI Types pane displays a tree with all subtypes of the selected CI type (for relationships, the Relationships pane displays a tree with all subtypes of the selected relationship). After selecting conditions in Conditions pane, click the <b>Preview</b>  button to open the Element Layout Preview dialog box.
Conditions pane	For details, see <a href="#">"Conditions Pane" below</a> .
No attributes	If you select <b>No attributes</b> , no attribute values are returned in the query results for the selected query node or relationship.
Select attributes for layout	If you select <b>Select attributes for layout</b> , you can select the attributes to be included in the query results for the selected query node or relationship.

### Conditions Pane

UI Element (A-Z)	Description
Attributes condition	Select one of the following options: <ul style="list-style-type: none"> <li>• <b>None.</b> No attributes are included in the query results for the selected element.</li> <li>• <b>All.</b> All attributes defined for the selected element are included in the query results.</li> <li>• <b>Specific Attributes.</b> Only the selected attributes are included in the query results for the selected element.</li> </ul>
Attributes with the following qualifiers	You can include attributes with specific qualifiers. Click the ellipsis button to open a dialog box with the available qualifiers and select the required

UI Element (A-Z)	Description
	qualifiers.  <div style="background-color: #f0f0f0; padding: 5px;"> <b>Note:</b> This feature only appears when you select <b>Specific Attributes</b> for the Attributes condition.                     </div>
<b>Available Attributes</b>	Displays all of the available attributes for the selected element.
<b>Excluded Attributes</b>	When <b>All</b> is selected as the Attributes condition, you can exclude selected attributes by moving them into the Excluded Attributes pane.  When <b>Specific Attributes</b> is selected as the Attributes condition for a CIT that has inherited an attribute selection from its parent CIT, you can exclude specific attributes from the selection by moving them to the Excluded Attributes pane.  Alternatively, if you select attributes with selected qualifiers for a CIT, you can exclude some attributes from that selection by moving them to the Excluded Attributes pane.  You can move attributes into and out of the pane using the arrow buttons.
<b>Exclude Specific Attributes</b>	Select this check box to enable the Available Attributes and Excluded Attributes panes and the arrow buttons.  <div style="background-color: #f0f0f0; padding: 5px;"> <b>Note:</b> This feature only appears when you select <b>All</b> for the Attributes condition.                     </div>
<b>Specific Attributes</b>	Displays the attributes to be included in the query results for the selected element. Move attributes into and out of the pane using the arrow buttons.  <div style="background-color: #f0f0f0; padding: 5px;"> <b>Note:</b> This feature only appears when you select <b>Specific Attributes</b> for the Attributes condition.                     </div>

### Qualifier Tab

This area enables you to define qualifier conditions for the selected query node or relationship. For example, you can use a qualifier to define a CIT as abstract, meaning you cannot create instances from it.

<b>To access</b>	Click the <b>Qualifier</b> tab in the Query Node/Relationship Properties dialog box.
------------------	--

<b>Important information</b>	By default, multiple selection links the conditions with the OR operator.  <div style="background-color: #f0f0f0; padding: 5px;"><b>Note:</b> This tab is only available in Enrichment Manager, Impact Analysis Manager, and the Input Query Editor in DFM.</div>
<b>Relevant tasks</b>	<ul style="list-style-type: none"> <li>• <a href="#">"How to Define an Impact Rule – Workflow" on page 467</a></li> <li>• <a href="#">"How to Define an Enrichment Rule – Scenario" on page 531</a></li> <li>• <a href="#">"How to Define a TQL Query" on page 24</a></li> <li>• Implement a Discovery Adapter in the <i>HP Universal CMDB Developer Reference Guide</i></li> <li>• <a href="#">"How to Create a Pattern View" on page 271</a></li> <li>• <a href="#">"How to Create a Template" on page 273</a></li> <li>• <a href="#">"How to Create a Perspective" on page 274</a></li> </ul>

User interface elements are described below:

<b>UI Element (A-Z)</b>	<b>Description</b>
<Qualifiers>	For a list of the available qualifier options, see <a href="#">"Qualifiers Page" on page 512</a> .
<b>Negate Qualifiers</b>	If this check box is selected, then the element is included in the query results only if it has no qualifier in the list of selected qualifiers.

## Identity Tab

This area enables you to filter the TQL query results according to the element ID of the instances found for the selected TQL query node.

<b>To access</b>	Click the <b>Identity</b> tab in the Query Node Properties dialog box.
<b>Important information</b>	Move the required element from the <b>Optional identities</b> pane on the left to the <b>Selected identities</b> pane on the right to define what you want included in the TQL query results using the left and right arrows.  <div style="background-color: #f0f0f0; padding: 5px;"><b>Note:</b> This tab only appears when a query node is selected.</div>

<b>Relevant tasks</b>	<ul style="list-style-type: none"> <li>• <a href="#">"How to Define an Impact Rule – Workflow" on page 467</a></li> <li>• <a href="#">"How to Define an Enrichment Rule – Scenario" on page 531</a></li> <li>• <a href="#">"How to Define a TQL Query" on page 24</a></li> <li>• Implement a Discovery Adapter in the <i>HP Universal CMDB Developer Reference Guide</i></li> <li>• <a href="#">"How to Create a Pattern View" on page 271</a></li> <li>• <a href="#">"How to Create a Template" on page 273</a></li> <li>• <a href="#">"How to Create a Perspective" on page 274</a></li> </ul>
-----------------------	--

The following elements are included (unlabeled elements are shown in angle brackets):

UI Element (A-Z)	Description
<Toolbar>	For descriptions of the toolbar buttons, see <a href="#">"CI Instances Dialog Box" on page 66</a> .
<b>Optional identities pane</b>	Displays all the instances found for the selected TQL query node.
<b>Selected identities pane</b>	Displays the elements that are used to define what should be included in the TQL query results.

## Refine Query Node Type Dialog Box

This dialog box enables you to change the CI type of a TQL query node after you have created a TQL query.

<b>To access</b>	<p>In Impact Analysis Manager or Enrichment Manager, right-click the required query node and select <b>Refine Query Node Type</b>.</p> <p><b>Note:</b> If you are using Enrichment Manager, select <b>Query</b> mode at the top of the editing pane to display the <b>Refine Query Node Type</b> option.</p>
<b>Important information</b>	You can change the CI type to a type from one of the CI type's children, if one exists. If no such CI type exists, this option does not appear.
<b>Relevant tasks</b>	<ul style="list-style-type: none"> <li>• <a href="#">"How to Define an Impact Rule – Workflow" on page 467</a></li> <li>• <a href="#">"How to Define an Enrichment Rule – Scenario" on page 531</a></li> <li>• <a href="#">"How to Define a TQL Query" on page 24</a></li> </ul>

	<ul style="list-style-type: none"> <li>• "Implement a Discovery Adapter" in the <i>HP Universal CMDB Developer Reference Guide</i></li> <li>• <a href="#">"How to Create a Pattern View" on page 271</a></li> <li>• <a href="#">"How to Create a Template" on page 273</a></li> <li>• <a href="#">"How to Create a Perspective" on page 274</a></li> </ul>
<b>See also</b>	<ul style="list-style-type: none"> <li>• <a href="#">"Topology Query Language (TQL) Overview" on page 14</a></li> <li>• <a href="#">"CI Type Manager" on page 485</a></li> </ul>

User interface elements are described below (unlabeled elements are shown in angle brackets):

UI Element (A-Z)	Description
<List of CI types from which to choose>	Select the required CI type.

## Select Relationship Type Dialog Box

This dialog box enables you to select the type of TQL relationship to be created.



<b>To access</b>	In the editing pane of Impact Analysis Manager, Enrichment Manager, and the Modeling Studio, click the <b>Create Relationship</b>  button on the toolbar and draw a line between two query nodes. The Select Relationship Type dialog box opens automatically.
<b>Important information</b>	<p>Select one of the following relationship types:</p> <ul style="list-style-type: none"> <li>• <b>Regular Relationship.</b> For details, see <a href="#">"Add/Edit Relationship Dialog Box" on page 54.</a></li> <li>• <b>Join Relationship.</b> For details, see <a href="#">"Add/Edit Join Relationship Dialog Box" on page 51.</a></li> <li>• <b>Compound Relationship.</b> For details, see <a href="#">"Add/Edit Compound Relationship Dialog Box" on page 48.</a></li> <li>• <b>Calculated Relationship.</b> For details, see <a href="#">"Add/Edit Calculated Relationship Dialog Box" on page 46.</a></li> </ul>
<b>Relevant tasks</b>	<ul style="list-style-type: none"> <li>• <a href="#">"How to Define an Impact Rule – Workflow" on page 467</a></li> <li>• <a href="#">"How to Define an Enrichment Rule – Scenario" on page 531</a></li> </ul>



	<ul style="list-style-type: none"> <li>• <a href="#">"How to Define a TQL Query" on page 24</a></li> <li>• <a href="#">"Implement a Discovery Adapter" in the <i>HP Universal CMDB Developer Reference Guide</i></a></li> <li>• <a href="#">"How to Create a Pattern View" on page 271</a></li> <li>• <a href="#">"How to Create a Template" on page 273</a></li> <li>• <a href="#">"How to Create a Perspective" on page 274</a></li> </ul>
<b>See also</b>	<ul style="list-style-type: none"> <li>• <a href="#">"How to Add Query Nodes and Relationships to a TQL Query" on page 26</a></li> <li>• <a href="#">"CI Type Relationships" on page 488</a></li> </ul>







## Subgraph Condition Definition Dialog Box

This dialog box enables you to create conditions that restrict the number of query nodes that appear in the query.

<b>To access</b>	<p>In Impact Analysis Manager, Enrichment Manager and the Input Query Editor in DFM, click <b>Condition</b>  in the Add Triplet dialog box.</p> <p>In the Modeling Studio, click <b>Condition</b>  in the Subgraph Definition dialog box.</p>
<b>Important information</b>	<p>Contains the following tabs:</p> <ul style="list-style-type: none"> <li>• <b>Attribute.</b> Enables you to define attribute conditions for query nodes and relationships. See a description of the elements in the <b>Attribute</b> tab in the table below. Each row represents an attribute condition that you specify. Use the And/Or column and the Brackets columns to link multiple conditions. In this way, you can construct a more precise logical statement to generate the required results.</li> <li>• <b>Qualifiers</b> (for Enrichment Manager, Impact Analysis Manager, and the Input Query Editor in DFM). Enables you to define qualifier conditions for the selected query node or relationship. For details, see <a href="#">"Qualifier Tab" on page 85</a>.</li> <li>• <b>Element Type</b> (for the Modeling Studio). Enables you to define subtype conditions for the selected query node or relationship. For details, see <a href="#">"Element Type Tab" on page 81</a>.</li> </ul>
<b>Relevant tasks</b>	<ul style="list-style-type: none"> <li>• <a href="#">"How to Define an Impact Rule – Workflow" on page 467</a></li> <li>• <a href="#">"How to Define an Enrichment Rule – Scenario" on page 531</a></li> <li>• <a href="#">"How to Define a TQL Query" on page 24</a></li> </ul>

	<ul style="list-style-type: none"> <li>• "Implement a Discovery Adapter" in the <i>HP Universal CMDB Developer Reference Guide</i></li> <li>• <a href="#">"How to Create a Pattern View" on page 271</a></li> <li>• <a href="#">"How to Create a Template" on page 273</a></li> <li>• "Microsoft Internet Information Services (IIS) Discovery" in the <i>HP UCMDB Discovery and Integrations Content Guide</i></li> <li>• <a href="#">"How to Create a Perspective" on page 274</a></li> </ul>
--	---



User interface elements are described below:

UI Element (A-Z)	Description
	<b>Add.</b> Adds the subgraph condition definition.
	<b>Delete.</b> Deletes the subgraph condition definition.
	<b>Up.</b> Moves a selected row up.
	<b>Down.</b> Moves a selected row down.
	<b>Show Criteria.</b> Displays the subgraph condition definition in a pop-up dialog box.
<b>And/Or</b>	Click inside the <b>And/Or</b> field and select either <b>And</b> or <b>Or</b> to link multiple conditions.
<b>Attribute name</b>	Choose an attribute from the list.
<b>Brackets</b> 	Click inside the <b>Brackets</b> box to display a list of brackets you can use to build more complex, logical statements.
<b>CIT</b>	Contains the CIT selected from the <b>Source</b> and <b>Target</b> lists.  <div style="background-color: #f0f0f0; padding: 5px;"><b>Note:</b> This option is not relevant when accessing the dialog box from the Modeling Studio.</div>
<b>Criteria</b>	Contains the attribute condition definition as defined in the CI Instances Dialog Box.
<b>Not</b>	Select <b>NOT</b> if you want the condition statement to do the opposite of what is defined.

UI Element (A-Z)	Description
	<p><b>Note:</b> If you select <b>NOT</b>, query results do not include data from the CI instances that were not assigned a value. For example, let us assume that your system contains three nodes. Node1 is assigned the value A, Node2 is assigned the value B and Node3 is not assigned a value. If you create a query in which you want to retrieve all nodes that are equal to A and you select <b>NOT</b>, the results of your query only include Node2 because Node3 is not assigned a value.</p>
<b>Operator</b>	Select the required operator. For details, see <a href="#">"Attribute Operator Definitions" on page 40.</a>
<b>Value</b>	Enter or select the value of the attribute. The <b>Value</b> options vary according to the attribute type you select.



## Subgraph Definition Dialog Box

This dialog box enables you to create a graph that represents additional TQL query data related to a specific CI.

<b>To access</b>	<p>To access in Enrichment Manager, Impact Analysis Manager, and the Modeling Studio:</p> <p>In the editing pane, right-click the required query node and select <b>Subgraph Definition</b>.</p> <p><b>Note:</b> If you are using Enrichment Manager, select <b>Query</b> mode at the top of the editing pane to display the <b>Subgraph Definition</b> option.</p> <p>To access in Adapter Management in DFM:</p> <ol style="list-style-type: none"> <li>1. Select an adapter in the Resources pane.</li> <li>2. In the <b>Adapter Definition</b> tab, click the <b>Edit Input Query</b>  button to the right of the <b>Input Query</b> box to open the Input Query Editor.</li> <li>3. Right-click the required query node and select <b>Subgraph Definition</b>.</li> </ol>
<b>Important information</b>	<p>The following icon is displayed next to the query node for which you define a subgraph:</p> 

<b>Relevant tasks</b>	<ul style="list-style-type: none"> <li>• <a href="#">"How to Define an Impact Rule – Workflow" on page 467</a></li> <li>• <a href="#">"How to Define an Enrichment Rule – Scenario" on page 531</a></li> <li>• <a href="#">"How to Define a TQL Query" on page 24</a></li> <li>• "Implement a Discovery Adapter" in the <i>HP Universal CMDB Developer Reference Guide</i></li> <li>• <a href="#">"How to Create a Pattern View" on page 271</a></li> <li>• <a href="#">"How to Create a Template" on page 273</a></li> <li>• <a href="#">"How to Create a Perspective" on page 274</a></li> </ul>
<b>See also</b>	<ul style="list-style-type: none"> <li>• <a href="#">"Subgraph Definition" on page 22</a></li> <li>• <a href="#">"How to Create a Subgraph Definition – Scenario" on page 33</a></li> </ul>

User interface elements are described below:

<b>UI Element (A-Z)</b>	<b>Description</b>
	<b>Add.</b> Adds a subgraph definition. In Enrichment Manager, Impact Analysis Manager, and the Input Query Editor in DFM, click to open the Add Triplet dialog box. In the Modeling Studio, click to add a row to the table.
	<b>Delete.</b> Deletes the selected subgraph definition.
	<b>Condition.</b> Enables you to edit a subgraph definition. In Impact Analysis Manager, Enrichment Manager, and the Input Query Editor in DFM, it opens the Edit Triplet dialog box. In the Modeling Studio, it opens the Subgraph Condition Definition dialog box.
<b>Depth</b>	A number that represents the longest path (that is, the maximum number of connecting query nodes) allowed between two CIs in the CMDB that should be included in the DFM process.  <b>Default:</b> 5
<b>Element condition exists</b>	A green asterisk appears next to either the source, relationship, or target in the subgraph definition if an attribute condition has been defined for one of them in the Subgraph Condition Definition dialog box. For details, see <a href="#">"Subgraph Condition Definition Dialog Box" on page 89</a> .
<b>Relationship</b>	The relationship selected connecting the source to the target query node.

UI Element (A-Z)	Description
<b>Relationship Direction</b>	The direction of the relationship selected, indicating which query node is dependent on the other.
<b>Source</b>	The required source query node selected.
<b>Target</b>	The required target query node selected.

## User Preferences Dialog Box

This dialog box enables you to reset system preferences.

<b>To access</b>	Select <b>Tools &gt; User Preferences</b> , or click the <b>Configure User Preferences</b>  button on the Status Bar.
<b>Important information</b>	All the preferences you select (such as whether to display certain wizard pages or warning message preferences) are stored in the system. This dialog box enables you to reset those preferences.

User interface elements are described below (unlabeled elements are shown in angle brackets):

UI Element (A-Z)	Description
<b>&lt;Left pane&gt;</b>	<p>Select the preferences page to edit. The following options are available:</p> <ul style="list-style-type: none"> <li>• <b>Wizard Preferences.</b> Enables you to define whether to hide or display certain wizard pages.</li> <li>• <b>Optional Messages Preferences.</b> Enables you to define whether to hide or display certain messages.</li> <li>• <b>Discovery Preferences.</b> Enables you to define:                             <ul style="list-style-type: none"> <li>◦ Whether to hide or display certain Discovery warning messages</li> <li>◦ The required default external editor (such as Notepad)</li> <li>◦ Whether to use Basic or Advanced Discovery mode</li> </ul> </li> <li>• <b>General.</b> Enables you to define general application preferences.</li> <li>• <b>Reports.</b> Enables you to set the category of Custom Reports selected by default.</li> </ul>

UI Element (A-Z)	Description
<Preferences list>	The list of warning messages and their user-selected preferences.
Filter by	Enter a search word to filter the list of options.
Reset All	Click to reset all the preferences to their default values.
Reset Page	Click to reset the selected preference to its default value.

## Troubleshooting and Limitations – Topology Query Language

This section describes troubleshooting and limitations for Topology Query Language.

- When creating resources, such as TQL queries, views, and Impact rules, make sure that there are no spaces at the end of the resource name.
- In a multi-tenancy environment, TQL query names cannot contain an @ character.
- If an error occurs while working with views in the Modeling managers, when adding CIs to the CMDB, or when updating existing CIs, and the error log indicates that objects are missing in the database, access the JMX console and run the following methods under service = DAL services:
  - **rebuildModelViews**
  - **rebuildModelDBSchemaAndViews**
- If the login takes a long time when navigating to the Modeling modules, go to Infrastructure Settings Manager and set the value of the **mam.gui.automation.flow.mapping.enabled** setting to false. This disables the Automation Flow functionality but improves the login time for the Modeling modules.
- For TQL queries to be valid, they must comply with certain restrictions.

This section includes the following topics:

- ["Understanding Validation Restrictions" on the next page](#)
- ["Impact Analysis TQL Query Validation" on page 96](#)
- ["Enrichment TQL Query Validation" on page 97](#)

### Understanding Validation Restrictions

For Impact Analysis, Discovery, and Enrichment TQL query types to be valid, they must comply with the following restrictions:

- **Unique Names.** TQL query elements must have unique names.
- **Self Relationships.** A TQL query must not contain self relationships, that is, a relationship must not lead from a query node to itself, as the following example illustrates:

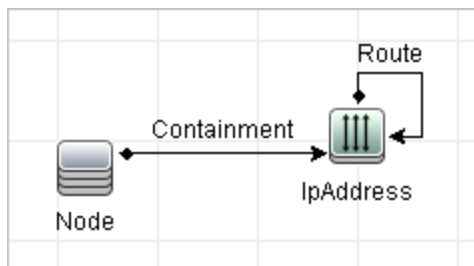

- **Cyclic Graph.** The TQL query structure cannot be a closed circle, as shown in the following example:

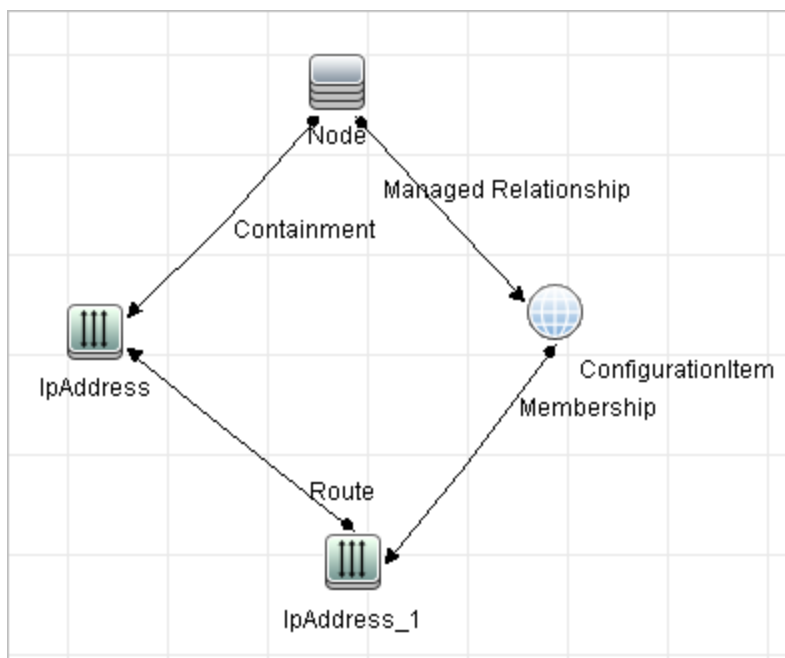

- **Separate Query Nodes and Groups.** All the TQL query nodes must be linked to one another, that is, the TQL query cannot contain separate query nodes or groups, as the following example

illustrates:

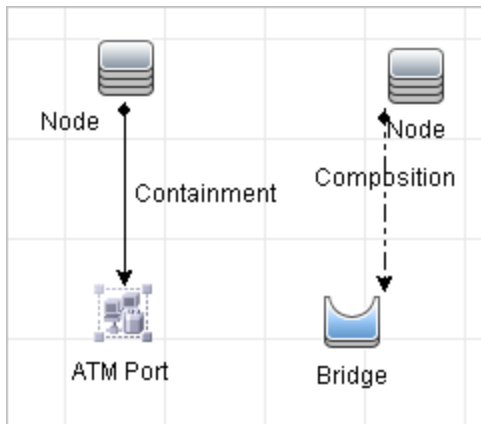

### Impact Analysis TQL Query Validation

Impact Analysis TQL queries must also comply with the following restrictions:

- **Number of query nodes.** An Impact Analysis TQL query must consist of at least two query nodes.
- **Trigger and affected query nodes must be connected.** There must be a path of relationships from the triggered query node to the affected query nodes.
- **Selecting query nodes to function as Impact Analysis triggers.** When selecting query nodes to function as Impact Analysis triggers, the query nodes must comply with the following restrictions:
  - You can select more than one query node as a trigger. However, you cannot define a query node both as affected and as a trigger.
  - If a query node has a relationship whose minimum limit is 0 (meaning that one of its ends does not necessarily have a query node linked to it), the query node that is linked to its other end cannot be a root cause query node (because it may or may not exist in the TQL query). For details about minimum limits, see "[Cardinality Tab](#)" on page 78. For example, **Configuration Item** cannot be either a root cause or affected query node because it is connected to the query node with a **Min** limit of 0.



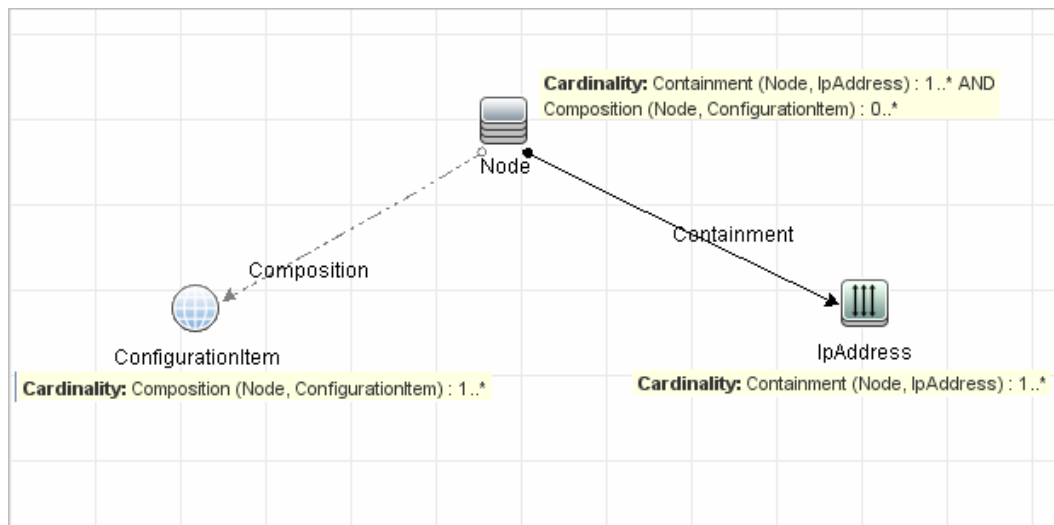

**Note:** A query node that is hidden cannot be a root cause or an affected query node.

- o **The connection between trigger and affected query nodes.** The trigger query node and affected query nodes you define must be connected by a path of relationships from the triggered query node to the affected query nodes.

### Enrichment TQL Query Validation

Enrichment TQL queries must comply with the following restriction:

- o **Required elements.** You cannot perform Enrichment on a non-required query node, that is, a query node that does not necessarily appear in the TQL query results.

**Example 1.** In this example, the TQL query results can be either **A** and **B** or **A** and **C**. Therefore, you cannot add an Enrichment query node to query nodes **B** or **C** because they are not required elements. You can add an Enrichment query node to query node **A** because it always appears in the TQL query results. For details on how to add Enrichment query nodes and relationships, see ["How to Add Enrichment Query Nodes and Relationships to an Enrichment TQL Query"](#) on page 536.

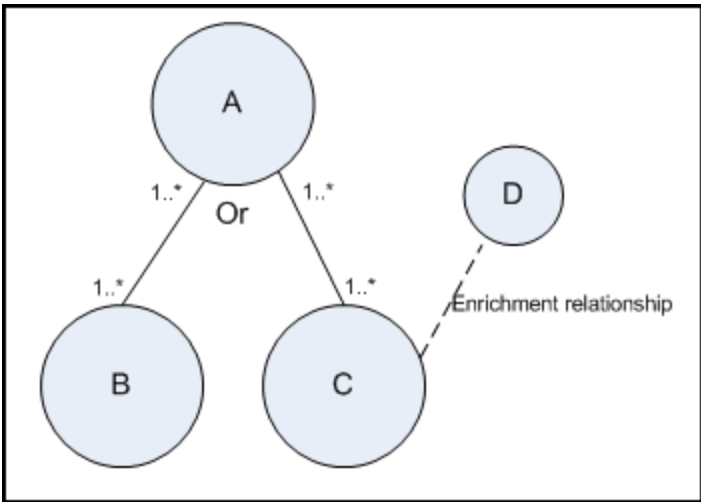

**Example 2.** In this example, both **A** and **B** are required elements that always appear in the TQL query results. Only **C** is not a required element because it has a cardinality of 0. Therefore, you cannot add an Enrichment query node to it.

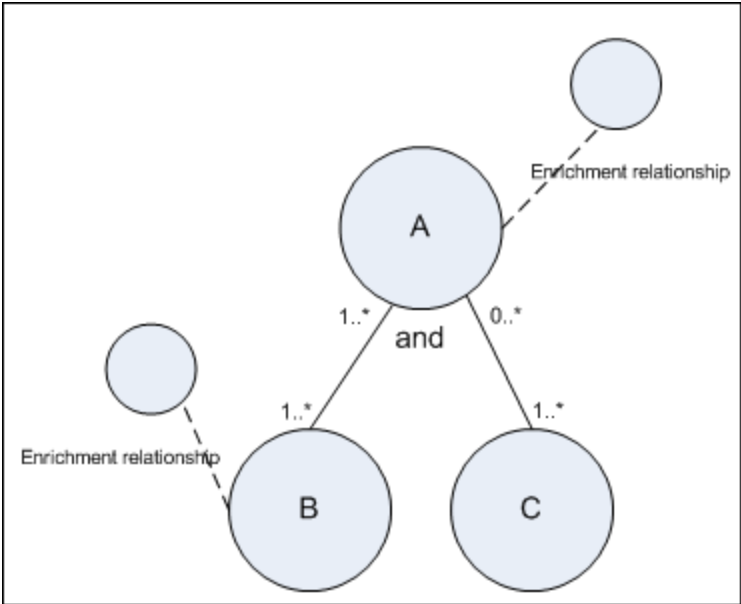

# Chapter 2: Using Calculated Relationships

This chapter includes:

Calculated Relationships Overview .....	99
Calculated Relationships .....	99
Calculated Relationship Types .....	100
How to Set Folding Rules for Composite CIs .....	100

## Calculated Relationships Overview

A calculated relationship represents the connection between two CIs, whose path meets the conditions defined for the triplets on which it is based in the CI Type Manager. For details on how to define triplets, see ["Triplets Page" on page 514](#).

You can use calculated relationships to create TQL queries just like any other relationship in the CI Type model. This enables you to base Enrichment rules, Impact rules, and views on calculated relationships.

The direction of the calculated relationship is not always the same direction as the physical relationship taken from the CI Type model. There can be one or more relationships between two CIs, depending on the way the triplets, on which the calculated relationship is based, are defined.

## Calculated Relationships

Calculated relationships are defined by one or more triplets. Each triplet is defined by the following components:

- One source CI type
- One target CI type
- A physical relationship type (for example, Containment) that links the two CI types
- The required direction. The direction can be identical to or opposite from the direction of the physical relationship between the source and target CIs.

Since calculated relationships are defined by physical relationships from within the class model, their lifetime is determined by the lifetime of the physical relationships. When the physical relationship in the class model is removed, the corresponding calculated relationship is removed from all view results as well.

**Note:** If you create a new CI type or relationship in the CI Type Manager, you need to define the required triplets.

#### Example of a Triplet Definition:



## Calculated Relationship Types

There is one out-of-the-box calculated relationship called **Impacted By**. **Impacted By** contains two subtypes, each one representing a different type of dependency relationship (complete dependency vs. potential dependency.)

- **Impacted by (Directly)**
- **Impacted By (Potentially)**

## How to Set Folding Rules for Composite CIs

This task describes how to configure the folding rules which define the composite CIs used in Configuration Manager. Composite CIs form the content of the managed views.

**Note:** This task is only relevant for users of HP Universal CMDB Configuration Manager.

This task includes the following steps:



- ["Prerequisites" on the next page](#)
- ["Define a folding rule with no conditions" on the next page](#)
- ["Define a folding rule with conditions" on page 102](#)

### 1. Prerequisites

Consider how you want to display the data in composite CIs in Configuration Manager and then decide on the rules for the scope of the composite CIs.

### 2. Define a folding rule with no conditions

- a. Select **Modeling > CI Type Manager**.
- b. Select **Calculated Relationships** from the list box in the CI Types pane. Under **Calculated Links**, select **Folding Rules (Configuration Manager)**.
- c. In the right pane, click the **Triplets** tab.
- d. In the **Triplets** tab, click  to open the Add Triplet dialog box. Define the triplet as follows:

UI Element	Description
<b>Source</b>	Select the required source CI type.
<b>Target</b>	Select the required target CI type.
<b>Relationship</b>	<p>Select the required relationship connecting the source and target CI types.</p> <div style="background-color: #f0f0f0; padding: 5px; border: 1px solid #ccc;"> <p><b>Note:</b> The list of available relationships appears only after defining the source and target CI types.</p> </div>
<b>Relationship Direction</b>	<p>Select the required direction.</p> <ul style="list-style-type: none"> <li>•  The direction is from source to target.</li> <li>•  The direction is from target to source.</li> </ul> <p>The direction of the relationship determines which is the composite CI and which is the component CI.</p> <ul style="list-style-type: none"> <li>• When the relationship's arrow is pointing to the target, the source query node is the composite CI and the target query node is the component CI:</li> </ul>

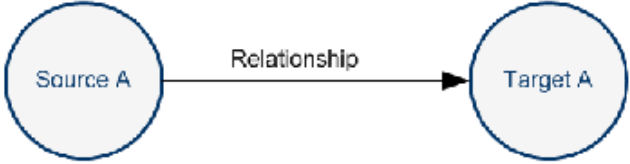
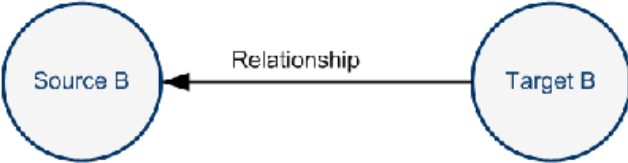
UI Element	Description
	<div style="display: flex; justify-content: space-around; align-items: flex-start;"> <div style="text-align: center;"> <p><b>Composite CI</b></p>  </div> <div style="text-align: center;"> <p><b>Component CI</b></p> </div> </div> <ul style="list-style-type: none"> <li>When the relationship's arrow is pointing to the source, the target query node is the composite CI and the source query node is the component CI:</li> </ul> <div style="display: flex; justify-content: space-around; align-items: flex-start;"> <div style="text-align: center;"> <p><b>Component CI</b></p>  </div> <div style="text-align: center;"> <p><b>Composite CI</b></p> </div> </div>

- e. Click **OK** to save your changes.

After saving the changes, Configuration Manager receives notification of the change and recalculates the relevant views.



### 3. Define a folding rule with conditions

Select this option if you want to specify attribute conditions for a specific node. Only CIs that match those conditions will be folded under the rule in Configuration Manager. For example, you can specify that only installed software with a specific name is a component CI of the node.

- a. Select **Modeling > Modeling Studio**.
- b. On the **Resources** tab, select **Queries** from the Resource Type list box.
- c. In the **Configuration Manager** node of the tree, click  and add a folder called **Filtered Folding Rules**, if one does not already exist.
- d. Select **New > Query** to open the TQL Query Editor. Define a TQL query that has the following structure:

**source > relation > target**

For details about the source and target nodes, see the table in "[Define a folding rule with no conditions](#)" on page 101. For general information about creating TQL queries, see [Define a TQL Query](#).

- e. Click the **Edit properties**  button and select **Perspective** in the Type drop-down list.
- f. Click **OK**.
- g. Right-click the source query node icon and select **Set As Contact Query Node**.
- h. Right-click the target query node icon and select **Query Node Properties**. Click  to specify the required conditions for the folding rule.
- i. Click **OK** to save your changes. The following picture shows an example of a TQL query that was defined for a folding rule. In this example, **Node** is the source of the TQL query and **InstalledSoftware** is the target:

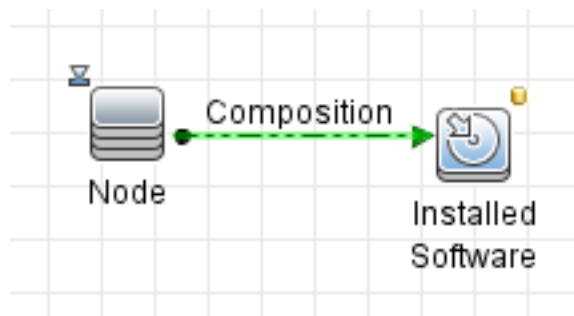

- j. Execute the following JMX command:
  - i. Access the JMX console by launching your Web browser and entering the following address: **http://<server\_name>:<port\_number>/cnc/jmx-console**, where **<server\_name>** is the name of the machine on which Configuration Manager is installed.
  - ii. Enter the JMX console authentication credentials.
  - iii. Click **Configuration Manager > View Service**. Select **updateFoldingRules** and click **Invoke**.
- k. Restart the Configuration Manager server.

## Chapter 3: Create a URL for a Direct Link

This chapter includes:

Generate a Direct Link – Overview .....	104
How to Generate a Direct Link – Scenario .....	105
How to Create a Direct Link to a Template with Parameter Values .....	105
How to Encrypt the Password of a Direct Link Using the JMX Console .....	106
Generate a Direct Link User Interface .....	107

### Generate a Direct Link – Overview

Direct Links enables you to create a URL that guides another user to a specific target view or CI in HP Universal CMDB.

You can create a URL that:

- Opens a specific HP Universal CMDB view or CI directly in HP Universal CMDB. This enables users to retrieve information from HP Universal CMDB without being located in the HP Universal CMDB context.

**Note:** To open a specific view or CI directly in HP Universal CMDB, use the **Open in context links** option. For details, see ["Select Command Page" on page 108](#).

- Enables integration with HP Universal CMDB:
  - If you create a URL using the Embedded links option, the URL takes you first to the HP Universal CMDB login page. After you enter your login name and password, the target page opens in your browser.

**Note:** To open the target page in your browser, use the **Embedded links** option. For details, see ["Select Command Page" on page 108](#).

When you create a URL, you can:



- Send the URL to an email recipient
- Copy the URL to the clipboard
- Test the URL to ensure that the target application page can be found

The user to whom you are sending the URL must have an account with sufficient privileges to open the target page. You must apply the appropriate viewing and editing permissions to the users and user groups that want to access the target view. You set permissions in **Managers > Security > Roles Manager**. For details, see "Roles Manager Page" in the *HP Universal CMDB Administration Guide*.

## How to Generate a Direct Link – Scenario

This scenario describes how to generate a direct link to email the URL of a specific CI to another person.

Jane Harrison is a senior engineer in the ABC Software company. She has encountered a problematic CI in a view she has created. She wants to inform Henry Jones, who is working with the same view through HP ServiceCenter, about the problematic CI. Since the view Jane has created contains many hundreds of CIs, she decides to email Henry the URL of the CI so that he does not have to spend a lot of time searching for that specific CI.

In IT Universe Manager, Jane selects **Generate Direct Link** from the **Edit** menu. On the Select Command page, she selects **Open in context links** and then the **Show view** option, and clicks **Next**.

On the **Direct Link Parameters — Show View** page, she selects the view she created, the problematic CI, and **View topology** as the mode in which Henry should open the CI. When the URL is created, she emails Henry the link to the problematic CI.

For details, see "[Generate Direct Link Wizard](#)" on page 108.

## How to Create a Direct Link to a Template with Parameter Values

This task describes how to create a direct link to a template by including the parameter values in the URL.

This task includes the following steps:

- ["Create a Direct Link to a Template" below](#)
- ["Edit the URL" below](#)
- ["Paste the URL into a Browser" below](#)

### 1. Create a Direct Link to a Template

In IT Universe Manager, select **Edit > Generate Direct Link** to run the Generate Direct Link wizard. On the Select Command page, select **Embedded links**. Select **Show view topology** from the list of options. On the Direct Link Parameters page, select the required template from the drop-down list.

### 2. Edit the URL

When the wizard finishes, click **Copy URL** and paste the URL into a text editor such as Notepad.

Append the following text to the end of the URL:

```
&params=[parameter1=value1,parameter2=value2]
```

where `parameter1` and `parameter2` are the parameter names for the selected template and `value1` and `value2` are the values you want to enter for the parameters.

**Note:** Any special characters must be entered using the URL encoding. In the above example, the URL encoding for the `[` character is `%5B`, the URL encoding for the `]` character is `%5D`, and the URL encoding for the comma is `%2C`. Thus, the actual text to enter is:

```
&params=%5Bparameter1=value1%2Cparameter2=value2%5D
```

### 3. Paste the URL into a Browser

Paste the URL into a browser. HP Universal CMDB opens to the selected template with the parameters assigned the specified values.

## How to Encrypt the Password of a Direct Link Using the JMX Console

This task describes how to encrypt the password contained within a direct link using the JMX console.

**To encrypt the password of a direct link using the JMX console:**

1. Launch your Web browser and enter the following address: **http://<server\_name>:<port number>/jmx-console**, where **<server\_name>** is the name of the machine on which HP Universal CMDB is installed.
2. Under **UCMDB-UI**, locate **UCMDB Integration**.
3. Under **getEncryptedPasswordForURL**, enter your user name and the password to encrypt.
4. Click **Invoke** to view the encrypted string.



## Generate a Direct Link User Interface

This section includes (in alphabetical order):

- ["Generate Direct Link Dialog Box" below](#)
- ["Generate Direct Link Wizard" on the next page](#)

## Generate Direct Link Dialog Box

This dialog box enables you to create a URL to send to users so that they can access HP Universal CMDB.

<p><b>To access</b></p>	<p>From the <b>Modeling</b> main menu, select <b>Edit &gt; Generate Direct Link</b>. After you configure the Direct Link parameters in the <a href="#">"Generate Direct Link Wizard" on the next page</a>, click <b>Finish</b> on the Finish page to open the Generate Direct Link dialog box.</p> <p>In IT Universe Manager, click the <b>Generate Direct Link to View</b>  button on the CI Selector toolbar in <b>Browse Views</b> mode.</p> <p>In the Reports module, click the <b>Generate Direct Link</b>  button on the toolbar or select <b>Operations &gt; Generate Direct Link &gt; Direct link to application</b> on the <b>Modeling</b> main menu.</p>
<p><b>Relevant tasks</b></p>	<p><a href="#">"How to Generate a Direct Link – Scenario" on page 105</a></p>
<p><b>See also</b></p>	<p><a href="#">"Generate a Direct Link – Overview" on page 104</a></p>

User interface elements are described below:

UI Element (A-Z)	Description
<b>Copy URL</b>	Copies the URL to the clipboard.
<b>Description</b>	Describes the parameters that are included in the URL. For details on selecting the parameters, see <a href="#">"Select Command Page" below</a> .
<b>Link URL</b>	The created URL that accesses the specified HP Universal CMDB function.
<b>Mail URL</b>	Opens an email containing the URL of the link.
<b>Test URL</b>	Checks the URL to ensure that the specified application page can be found.  <b>Note:</b> This button is not available when using Linux.

## Generate Direct Link Wizard

This wizard enables you to create a URL that guides another user to a specific target view or CI in HP Universal CMDB.

<b>To access</b>	From the <b>Modeling</b> main menu, select <b>Edit &gt; Generate Direct Link</b> .
<b>Important information</b>	By default, this wizard is set to display a Welcome page. You can choose not to display the Welcome page by selecting the <b>Do not show this page again</b> check box.
<b>Relevant tasks</b>	<a href="#">"How to Generate a Direct Link – Scenario" on page 105</a>
<b>Wizard map</b>	The Generate Direct Link wizard contains:  <a href="#">"Select Command Page"</a> (<Open in context links options> and <Embedded links options>) > <a href="#">"Finish Page"</a>
<b>See also</b>	<a href="#">"Generate a Direct Link – Overview" on page 104</a>

## Select Command Page

This wizard page enables you to select the required parameters that must be added to the URL.

You can create two types of links:

- **Open in context links.** Creates a URL that opens a specific view or CI directly in HP Universal CMDB without having to be in the HP Universal CMDB context:

- **Embedded links.** Creates a URL that enables you to embed an HP Universal CMDB applet into external applications.

<b>Important information</b>	By default, this wizard is set to display a Welcome page. You can choose not to display the Welcome page by selecting the <b>Do not show this page again</b> check box.
<b>Wizard map</b>	The Generate Direct Link wizard contains:  " <b>Select Command Page</b> " (<Open in context links options> and <Embedded links options>) > " <b>Finish Page</b> "
<b>See also</b>	<a href="#">"Generate Direct Link Wizard" on the previous page</a>

User interface elements are described below (unlabeled elements are shown in angle brackets):

<b>UI Element (A-Z)</b>	<b>Description</b>
<b>&lt;Left pane&gt;</b>	A graphic illustration of the selected command.
<b>CII Grid</b>	Creates a URL that displays all the CI instances found in the CMDB for a selected CI type and its children. For details, see <a href="#">"Direct Link Parameters – CII Grid Page" on page 113</a> .  <b>Note:</b> Available when you select the <b>Embedded links</b> option.
<b>CI Selector</b>	Creates a URL that embeds the CI Selector displaying the CIs of a selected view, into external applications. For details, see <a href="#">"Direct Link Parameters – CI Selector Page" on page 111</a> .  <b>Note:</b> Available when you select the <b>Embedded links</b> option.
<b>CI Type Selector</b>	Creates a URL that embeds the CI type selector into external applications. For details, see <a href="#">"Direct Link Parameters – CI Type Selector Page" on page 112</a> .  <b>Note:</b> Available when you select the <b>Embedded links</b> option.
<b>Description</b>	A description of the selected command.
<b>Impact Map</b>	Creates a URL that embeds an impact map into an external application. For details, see <a href="#">"Direct Link Parameters – Impact Map Page" on page 114</a> .  <b>Note:</b> Available when you select the <b>Embedded links</b> option.

UI Element (A-Z)	Description
<b>Model Editor</b>	<p>Creates a URL that embeds the Model Editor into an external application, highlighting the selected CIs in the CI Selector in the Model Editor. For details, see <a href="#">"Direct Link Parameters – Model Editor" on page 115</a>.</p> <p><b>Note:</b> Available when you select the <b>Embedded links</b> option.</p>
<b>Query Editor</b>	<p>Creates a URL that embeds the Model Editor into an external application, displaying the selected TQL query. For details, see <a href="#">"Direct Link Parameters – Query Editor" on page 116</a>.</p> <p><b>Note:</b> Available when you select the <b>Embedded links</b> option.</p>
<b>Related CIs</b>	<p>Creates a URL that opens a topology map displaying the selected CI and its immediate neighbors within the selected view. For details, see <a href="#">"Direct Link Parameters – Related CIs Page" on page 116</a>.</p> <p><b>Note:</b> Available when you select the <b>Embedded links</b> option.</p>
<b>Report Viewer</b>	<p>Creates a URL that opens a specific report. For details, see <a href="#">"Direct Link Parameters – Report Viewer Page" on page 117</a>.</p> <p><b>Note:</b> Available when you select the <b>Embedded links</b> option.</p>
<b>Report Viewer - Saved Report</b>	<p>Creates a URL that opens a saved topology or custom report. For details, see <a href="#">"Direct Link Parameters – Report Viewer – Saved Report Page" on page 117</a>.</p> <p><b>Note:</b> Available when you select the <b>Embedded links</b> option.</p>
<b>Show CI properties</b>	<p>Creates a URL that displays a CI's properties. For details, see <a href="#">"Direct Link Parameters – Show CI Properties Page" on page 118</a>.</p> <p><b>Note:</b> Available when you select the <b>Embedded links</b> option.</p>
<b>Show view</b>	<p>Creates a URL that displays the selected view and optionally preselects a query node in it. For details, see <a href="#">"Direct Link Parameters – Show View Page" on page 120</a>.</p> <p><b>Note:</b> Available when you select the <b>Open in context links</b> option.</p>



UI Element (A-Z)	Description
<b>Show view topology</b>	<p>Creates a URL that displays the topology map of the selected view and embeds it in an external application. For details, see <a href="#">"Direct Link Parameters – Show View Topology Page"</a> on page 119.</p> <p><b>Note:</b> Available when you select the <b>Embedded links</b> option.</p>
<b>Start in mode</b>	<p>Creates a URL that opens HP Universal CMDB at the selected page. For details, see <a href="#">"Direct Link Parameters – Start in Mode Page"</a> on page 121.</p> <p><b>Note:</b> Available when you select the <b>Open in context links</b> option.</p>
<b>Steps</b>	The current step in the procedure.
<b>View Editor</b>	<p>Creates a URL that opens a specific view in the Pattern View Editor in Modeling Studio. For details, see <a href="#">"Direct Link Parameters – View Editor Page"</a> on page 119.</p> <p><b>Note:</b> Available when you select the <b>Embedded links</b> option.</p>
<b>Views Selector</b>	<p>Creates a URL that embeds the View Selector in an external application, enabling you to select and display a view in that application. For details, see <a href="#">"Direct Link Parameters – Views Selector Page"</a> on page 120.</p> <p><b>Note:</b> Available when you select the <b>Embedded links</b> option.</p>

## Direct Link Parameters – CI Selector Page

This wizard page enables you to create a URL that embeds the CI Selector displaying the CIs of a selected view, into external applications.

<b>Wizard map</b>	<a href="#">"Select Command Page"</a> (Embedded links > CI Selector) > <a href="#">"Finish Page"</a>
<b>Important information</b>	<ul style="list-style-type: none"> <li>For general information about the Generate Direct Link wizard, see <a href="#">"Generate Direct Link Wizard"</a> on page 108.</li> <li>Click <b>Finish</b> to close the wizard and create a URL. For details, see <a href="#">"Generate Direct Link Dialog Box"</a> on page 107.</li> </ul>

User interface elements are described below:





UI Element (A-Z)	Description
<b>Allow multi selection</b>	Allow single or multiple selection of CIs.
<b>Selected view</b>	<p>Select the required view from which you want to select the required CIs.</p> <ul style="list-style-type: none"> <li>Click  to open the View Selector dialog box. Select the view you want to appear in the CI Selector.</li> <li>Click  to delete the selected view.</li> </ul>

## Direct Link Parameters – CI Type Selector Page





This wizard page enables you to create a URL to a hierarchical tree or list of selected CI types, which can be embedded into an external application.

<b>Important information</b>	<ul style="list-style-type: none"> <li>For general information about the Generate Direct Link wizard, see <a href="#">"Generate Direct Link Wizard" on page 108</a>.</li> <li>Click <b>Finish</b> to close the wizard and create a URL. For details, see <a href="#">"Generate Direct Link Dialog Box" on page 107</a>.</li> </ul>
<b>Wizard map</b>	<a href="#">"Select Command Page"</a> (Embedded links > CI Type selector) > <a href="#">"Finish Page"</a>

User interface elements are described below:

UI Element (A-Z)	Description
<b>CI type selector mode</b>	View the selected CI types in either a hierarchical tree or list.
<b>Invisible CITs (tree only)</b>	<p>Select the CI types you do not want to appear in the tree.</p> <ul style="list-style-type: none"> <li>Click  to open the CI Type Selector dialog box. Select the CI types you want to appear in the tree.</li> <li>Click  to delete the selected CI types.</li> </ul>
<b>Root CI Type (tree only)</b>	<p>Select the CI type you want to use as the root CI type in a hierarchical tree.</p> <ul style="list-style-type: none"> <li>Click  to open the CI Type Selector dialog box. Select the CI type you want to use as the root CI type in the tree.</li> <li>Click  to delete the selected CI type. The default is <b>Configuration Item</b>.</li> </ul>



UI Element (A-Z)	Description
<b>Selection mode</b>	Allow single or multiple selection of CI types.
<b>Unselectable CITs (tree only)</b>	<p>Select the CI types which cannot be selected in the tree.</p> <ul style="list-style-type: none"> <li>Click  to open the CI Type Selector dialog box. Select the CI types which cannot be selected in the tree.</li> <li>Click  to delete the selected CI types.</li> </ul>
<b>Visible CITs (list only)</b>	<p>Select the CI types which you want to appear in the CI type list.</p> <ul style="list-style-type: none"> <li>Click  to open the CI Type Selector dialog box. Select the CI types which you want to appear in the CI type list.</li> <li>Click  to delete the selected CI types.</li> </ul> <p><b>Note:</b> If you choose to view the CITs in a list, then you are required to select at least one CI type.</p>

## Direct Link Parameters – CII Grid Page

This wizard page enables you to display all of the CI instances found in the CMDB for the selected CI type and for its children.

<b>Important information</b>	<ul style="list-style-type: none"> <li>For general information about the Generate Direct Link wizard, see <a href="#">"Generate Direct Link Wizard" on page 108</a>.</li> <li>Click <b>Finish</b> to close the wizard and create a URL. For details, see <a href="#">"Generate Direct Link Dialog Box" on page 107</a>.</li> </ul>
<b>Wizard map</b>	<a href="#">"Select Command Page"</a> (Embedded links > CII Grid) > <a href="#">"Finish Page"</a>
<b>See also</b>	<a href="#">"CI Instances Dialog Box" on page 66</a>

User interface elements are described below:

UI Element (A-Z)	Description
<b>Class type</b>	<p>Select the required CI type.</p> <ul style="list-style-type: none"> <li>Click  to select the required CI type.</li> </ul>



UI Element (A-Z)	Description
	<ul style="list-style-type: none"> <li>Click  to clear the box.</li> </ul>



## Direct Link Parameters – Impact Map Page

This wizard page enables you to run an Impact Analysis rule defined in Impact Analysis Manager. The URL you create enables you to embed a topology map showing a simulation of all the CIs that are affected by the selected trigger CI for the selected severity and state. For details, see ["Run Impact Analysis Dialog Box" on page 247](#).

<b>Important information</b>	<ul style="list-style-type: none"> <li>For general information about the Generate Direct Link wizard, see <a href="#">"Generate Direct Link Wizard" on page 108</a>.</li> <li>Click <b>Finish</b> to close the wizard and create a URL. For details, see <a href="#">"Generate Direct Link Dialog Box" on page 107</a>.</li> </ul>
<b>Wizard map</b>	<a href="#">"Select Command Page"</a> (Embedded links > Impact map) > <a href="#">"Finish Page"</a>
<b>See also</b>	<a href="#">"IT Universe Manager" on page 181</a>

User interface elements are described below:

UI Element (A-Z)	Description
<b>Filter by CI types</b>	<p>Select the CI types you do not want to appear in the impact analysis results.</p> <ul style="list-style-type: none"> <li>Click  to select the required CI types.</li> <li>Click  to delete the selected CI types.</li> </ul>
<b>Rule bundle</b>	Enables you to define where you can run Impact Analysis rules.
<b>Severity</b>	<p>Select the required severity from the drop-down list.</p> <div style="background-color: #f0f0f0; padding: 5px; margin: 5px 0;"> <p><b>Note:</b> The severity list was defined for the state in the System Type Manager. For details, see <a href="#">"System Type Manager" on page 489</a>.</p> </div> <p>For example, you can create an Impact rule in the Impact Analysis Manager (see the <a href="#">"Impact Rules Definition Dialog Box" on page 479</a>, that defines the severity of the trigger query node as other than <b>No Change</b>. If you select a severity other than <b>No Change</b>, for</p>



UI Element (A-Z)	Description
	<p>example, <b>Plan</b>, the condition is met and the simulated changes in the system are triggered.</p> <p>For details, see <a href="#">"Run Impact Analysis Dialog Box" on page 247</a>.</p>
<b>Trigger CIs</b>	<ul style="list-style-type: none"> <li>Click  to select the CIs that are used as the triggers in an impact map. These CIs represent the simulated changes to be made to the system. Opens the CI Selector dialog box. For details on how to use the CI Selector pane, see <a href="#">"CI Selector" on page 135</a>.</li> <li>Click  to delete the selected CIs.</li> </ul>



## Direct Link Parameters – Model Editor

This wizard page enables you to embed the Model Editor into an external application, highlighting the selected CIs in the CI Selector in the Model Editor.

<b>Important information</b>	<ul style="list-style-type: none"> <li>For general information about the Generate Direct Link wizard, see <a href="#">"Generate Direct Link Wizard" on page 108</a>.</li> <li>Click <b>Finish</b> to close the wizard and create a URL. For details, see <a href="#">"Generate Direct Link Dialog Box" on page 107</a>.</li> </ul>
<b>Wizard map</b>	<a href="#">"Select Command Page"</a> (Embedded links > Model Editor) > <a href="#">"Finish Page"</a>
<b>See also</b>	<a href="#">"Business CI Models" on page 262</a>

User interface elements are described below:

UI Element (A-Z)	Description
<b>Model name</b>	<p>Select the model you want to display in the Model Editor.</p> <ul style="list-style-type: none"> <li>Click  to open the Select Model dialog box. Select the model you want to appear in the Model Editor.</li> <li>Click  to delete the selected model.</li> </ul>
<b>Selected CI in search</b>	Select the CIs you want to appear highlighted in the CI Selector in the Model Editor.



UI Element (A-Z)	Description
	<ul style="list-style-type: none"> <li>Click  to open the CI Selector.</li> <li>Click  to delete the selected CIs.</li> </ul>

## Direct Link Parameters – Query Editor

This wizard page enables you to embed the Model Editor into an external application, displaying the selected TQL query.

<b>Important information</b>	<ul style="list-style-type: none"> <li>For general information about the Generate Direct Link wizard, see <a href="#">"Generate Direct Link Wizard" on page 108</a>.</li> <li>Click <b>Finish</b> to close the wizard and create a URL. For details, see <a href="#">"Generate Direct Link Dialog Box" on page 107</a>.</li> </ul>
<b>Wizard map</b>	<a href="#">"Select Command Page"</a> (Embedded links > Query Editor) > <a href="#">"Finish Page"</a>
<b>See also</b>	<a href="#">"Business CI Models" on page 262</a>

User interface elements are described below:







UI Element (A-Z)	Description
<b>Query name</b>	<p>Select the model you want to display in the Model Editor.</p> <ul style="list-style-type: none"> <li>Click  to open the Select Query dialog box. Select the query you want to appear in the Model Editor.</li> <li>Click  to delete the selected query.</li> </ul>

## Direct Link Parameters – Related CIs Page

This wizard page enables you to embed a topology map into an external application. The map displays a specific CI, and all the CIs that are linked to it by a distance of no more than one relationship.

<b>Important information</b>	<ul style="list-style-type: none"> <li>For general information about the Generate Direct Link wizard, see <a href="#">"Generate Direct Link Wizard" on page 108</a>.</li> <li>Click <b>Finish</b> to close the wizard and create a URL. For details, see <a href="#">"Generate Direct Link Dialog Box" on page 107</a>.</li> </ul>
<b>Wizard map</b>	<a href="#">"Select Command Page"</a> (Embedded links > Related CIs) > <a href="#">"Finish Page"</a>

User interface elements are described below (unlabeled elements are shown in angle brackets>):

UI Element (A-Z)	Description
<b>CI</b> s	<p>Select the CI type you want to appear in the topology map.</p> <ul style="list-style-type: none"> <li>Click  to select the required CI types. Opens the CI Selector dialog box.</li> <li>Click  to delete the value in the <b>CI</b>s box.</li> </ul>
<b>Filter by CI types</b>	<p>Restrict the results of the topology map to related CIs of one or more CI types.</p> <ul style="list-style-type: none"> <li>Click  to select the required CI types.</li> <li>Click  to delete the value in the <b>Filter by CI types</b> box.</li> </ul>
<b>Restrict to view</b>	<p>Restrict the results of the topology map to related CIs from a specific view.</p> <ul style="list-style-type: none"> <li>Click  to select the required view. Opens the View Selector dialog box.</li> <li>Click  to delete the selected view in the <b>Restrict results to view</b> box.</li> </ul>

## Direct Link Parameters – Report Viewer Page

This wizard page enables you to create a URL that opens a specific report.

<b>Important information</b>	<ul style="list-style-type: none"> <li>For general information about the Generate Direct Link wizard, see <a href="#">"Generate Direct Link Wizard" on page 108</a>.</li> <li>Click <b>Finish</b> to close the wizard and create a URL. For details, see <a href="#">"Generate Direct Link Dialog Box" on page 107</a>.</li> </ul>
<b>Wizard map</b>	<a href="#">"Select Command Page"</a> (Embedded links > Report Viewer) > <a href="#">"Finish Page"</a>

User interface elements are described below:



UI Element (A-Z)	Description
<b>Report type</b>	Select the required report type. For information about the different report types, see <a href="#">"Reports" on page 356</a> .

## Direct Link Parameters – Report Viewer – Saved Report Page

This wizard page enables you to create a URL that opens a saved topology or custom report.

<b>Important information</b>	<ul style="list-style-type: none"> <li>For general information about the Generate Direct Link wizard, see <a href="#">"Generate Direct Link Wizard" on page 108</a>.</li> <li>Click <b>Finish</b> to close the wizard and create a URL. For details, see <a href="#">"Generate Direct Link Dialog Box" on page 107</a>.</li> </ul>
<b>Wizard map</b>	<a href="#">"Select Command Page"</a> (Embedded links > Report Viewer - Saved Report) > <a href="#">"Finish Page"</a>

User interface elements are described below:

UI Element (A-Z)	Description
<b>Report</b>	<p>Select the required saved report.</p> <ul style="list-style-type: none"> <li>Click  to open the Select Report dialog box. Select the required topology or custom report.</li> <li>Click  to delete the selected report.</li> </ul> <p>For information about saved reports, see <a href="#">"Reports" on page 356</a>.</p>

## Direct Link Parameters – Show CI Properties Page

This wizard page enables you to view basic information for an existing CI.

<b>Important information</b>	<ul style="list-style-type: none"> <li>For general information about the Generate Direct Link wizard, see <a href="#">"Generate Direct Link Wizard" on page 108</a>.</li> <li>Click <b>Finish</b> to close the wizard and create a URL. For details, see <a href="#">"Generate Direct Link Dialog Box" on page 107</a>.</li> </ul>
<b>Wizard map</b>	<a href="#">"Select Command Page"</a> (Embedded links > Show CI properties) > <a href="#">"Finish Page"</a>
<b>See also</b>	<a href="#">"Configuration Item Properties Dialog Box" on page 220</a>

User interface elements are described below:

UI Element (A-Z)	Description
<b>Source CI object ID</b>	<p>Select the required CI.</p> <ul style="list-style-type: none"> <li>Click  to select the source CI and retrieve its object ID. Opens the Select Source CI dialog box. For details, see <a href="#">"CI Selector" on page 135</a>.</li> </ul>



UI Element (A-Z)	Description
	<ul style="list-style-type: none"> <li>Click  to delete the value in the <b>Source CI object ID</b> box.</li> </ul>

## Direct Link Parameters – Show View Topology Page

This wizard page enables you to display the topology map of the selected view and embed it in an external application.

<b>Important information</b>	<ul style="list-style-type: none"> <li>For general information about the Generate Direct Link wizard, see <a href="#">"Generate Direct Link Wizard" on page 108</a>.</li> <li>Click <b>Finish</b> to close the wizard and create a URL. For details, see <a href="#">"Generate Direct Link Dialog Box" on page 107</a>.</li> </ul>
<b>Wizard map</b>	<a href="#">"Select Command Page"</a> (Embedded links > Show view topology) > <a href="#">"Finish Page"</a>

User interface elements are described below:



UI Element (A-Z)	Description
<b>Show topology of view</b>	<ul style="list-style-type: none"> <li>Click  to select the required view to be opened by the URL. Opens the View Selector dialog box.</li> <li>Click  to delete the selected view in the Show topology of view box.</li> </ul>

## Direct Link Parameters – View Editor Page

This wizard page enables you to create a URL that opens a specific view in the Pattern View Editor in Modeling Studio.

<b>Important information</b>	<ul style="list-style-type: none"> <li>For general information about the Generate Direct Link wizard, see <a href="#">"Generate Direct Link Wizard" on page 108</a>.</li> <li>Click <b>Finish</b> to close the wizard and create a URL. For details, see <a href="#">"Generate Direct Link Dialog Box" on page 107</a>.</li> </ul>
<b>Wizard map</b>	<a href="#">"Select Command Page"</a> (Embedded links > View Editor) > <a href="#">"Finish Page"</a>
<b>See also</b>	<a href="#">"Building a Business View" on page 255</a>

User interface elements are described below:

UI Element (A-Z)	Description
<b>View name</b>	<ul style="list-style-type: none"> <li>Click  to select the required view to be opened by the URL. Opens the View Selector dialog box.</li> <li>Click  to delete the selected view in the View name box.</li> </ul>

## Direct Link Parameters – Views Selector Page

This wizard page enables you to embed into an external application, the View Selector, that enables you to select, and display a view in that application.

<b>Important information</b>	<ul style="list-style-type: none"> <li>For general information about the Generate Direct Link wizard, see <a href="#">"Generate Direct Link Wizard" on page 108</a>.</li> <li>Click <b>Finish</b> to close the wizard and create a URL. For details, see <a href="#">"Generate Direct Link Dialog Box" on page 107</a>.</li> </ul>
<b>Wizard map</b>	<a href="#">"Select Command Page"</a> (Embedded links > Views Selector) > <a href="#">"Finish Page"</a>
<b>See also</b>	<a href="#">"Building a Business View" on page 255</a>

## Direct Link Parameters – Show View Page





This wizard page enables you to create a URL to a specific view and optionally select a specific query node in that view. When the view opens, the CI you chose is selected in the view. The view opens in IT Universe Manager.

<b>Important information</b>	<ul style="list-style-type: none"> <li>For general information about the Generate Direct Link wizard, see <a href="#">"Generate Direct Link Wizard" on page 108</a>.</li> <li>Click <b>Finish</b> to close the wizard and create a URL. For details, see <a href="#">"Generate Direct Link Dialog Box" on page 107</a>.</li> </ul>
<b>Wizard map</b>	<a href="#">"Select Command Page"</a> (Open in context links > Show view) > <a href="#">"Finish Page"</a>

User interface elements are described below:

UI Element (A-Z)	Description
<b>&lt;Left pane&gt;</b>	A graphic illustration of the selected option.



UI Element (A-Z)	Description
<b>Advanced pane (visibility)</b>	Hide or display the Advanced pane in IT Universe Manager.
<b>Select CI from view result</b>	<p>(Optional) Click to select a CI and retrieve its object ID. When the view opens, the CI you chose is selected in the view.</p> <ul style="list-style-type: none"> <li>Click  to choose the CI you want selected in the target view and retrieve its object ID. Opens the Select CI dialog box. For details, see <a href="#">"CI Selector" on page 135</a>.</li> <li>Click  to delete the object ID for the selected CI in the <b>Select CI from view result</b> box.</li> </ul>
<b>Selected View</b>	<p>The target view to be opened by the URL.</p> <ul style="list-style-type: none"> <li>Click  to select the target view to be opened by the URL. Opens the Select View dialog box.</li> <li>Click  to delete the selected view in the <b>Selected view</b> box.</li> </ul>
<b>View mode</b>	<p>The view options are:</p> <ul style="list-style-type: none"> <li><b>View Topology.</b> Displays an entire layer within a view.</li> <li><b>Related in View.</b> Displays the selected CI and its immediate neighbors within the current view.</li> <li><b>Related in CMDB.</b> Displays the selected CI and its immediate neighbors in the CMDB.</li> </ul>

## Direct Link Parameters – Start in Mode Page

This wizard page enables you to start the UCMDB application at the selected page, for example, in the Modeling Studio page.

<b>Important information</b>	<ul style="list-style-type: none"> <li>For general information about the Generate Direct Link wizard, see <a href="#">"Generate Direct Link Wizard" on page 108</a>.</li> <li>Click <b>Finish</b> to close the wizard and create a URL. For details, see <a href="#">"Generate Direct Link Dialog Box" on page 107</a>.</li> </ul>
<b>Wizard map</b>	<a href="#">"Select Command Page"</a> (Open in context links > Start in mode page) > <a href="#">"Finish"</a>

	Page"
--	-------

User interface elements are described below (unlabeled elements are shown in angle brackets):

UI Element (A-Z)	Description
<Left pane>	A graphic illustration of the selected mode.
Initial mode	Starts the UCMDB application in the selected mode.

## Finish Page

This is the final page of the Generate Direct Link wizard. Click **Finish** to close the wizard and create a URL. Opens the Generate Direct Link dialog box.

<b>Important information</b>	For general information about the Generate Direct Link wizard, see " <a href="#">Generate Direct Link Wizard</a> " on page 108.
<b>Wizard map</b>	" <a href="#">Select Command Page</a> " (<Open in context links options> and <Embedded links options>) > " <b>Finish Page</b> "

# Chapter 4: Embedding UCMDB Applets Using Direct Links

This chapter includes:

Using the Direct Link Functionality to Embed UCMDB Applets .....	123
UCMDB Applet Tag Overview .....	124
Direct Link Operation Flow .....	125

**Note:** This chapter is relevant to integration developers only.

## Using the Direct Link Functionality to Embed UCMDB Applets

You can directly embed UCMDB applets into external applications using a direct link. A direct link is a URL that you create using the Direct Links wizard. For details, see ["Generate Direct Link Wizard" on page 108](#).

You can embed UCMDB applets in the following ways:

- Using the URL itself to display CMDB content in an external application. For example, you can create a URL in the Direct Links wizard to display the properties of a certain CI. The login page opens if you are not already logged into HP Universal CMDB.

**Note:** Using the URL to enable the integration requires opening the link in an IFrame or a new window. This does not allow you to manage the resulting UCMDB applet using Javascript due to cross-site scripting issues. For example, if you use a URL that displays the properties of a specific CI using the object ID, you cannot use the same URL to display the properties of another CI.

- Using the UCMDB applet tag to embed the UCMDB applet in an external application. This enables integration developers to display a part of the HP Universal CMDB user interface as part of their own application. In addition, this enables interaction with the embedded HP Universal CMDB user interface using Javascript.

## UCMDB Applet Tag Overview

The UCMDB Applet tag creates the environment needed for the UCMDB applet to run (HTML, Javascript, and server session parameters). The code behind the tag can log into the HP Universal CMDB server in one of the following cases:

- The login parameters are specified and the user is not already logged in.
- The **clear session** parameter is true.

Once a user session is established, the tag continues to write the required applet environment (HTML and Javascript code) to the result of the JSP processor. The resulting HTML page includes the required Javascript code to load the UCMDB applet from the specified server. On error, the specified error string is printed to the page. This string can be customized using the **userErrorMessage** parameter and may include HTML elements and HTML wrapped Javascript code to initiate error handling scenarios.

### Example of the Usage of a UCMDB Applet Tag

```
<ucmdb:ucmdb_applet
serverConnectionString="http://server_name.server_domain:server_port"
serverType="UCMDB"
directLinkParameters="initViewName=NetworkTopology"
userName="user-name"
userPassword="password"
customerId="1"
encoded="false"
printDebugLogs="true"
userErrorMessage="This is your general error"
navigation="false"
clearSessionCookies="false"
command="ShowCISelector"/>
```

**Caution:** You retrieve the **directLinkParameters** from the URL created in the Direct Links wizard. Insert the values for each parameter in the tag as displayed. If the URL contains values for parameters not displayed above, copy them into the **directLinkParameters** line of the tag. For details on how to create a direct link, see ["Generate Direct Link Wizard" on page 108](#).

The UCMDB applet tag is located at **<HP Universal CMDB root folder>\deploy\ucmdb-ui\WEB-INF\tags\ucmdb\_applet.tag**.

You can copy the UCMDB applet tag to an external application server. The UCMDB applet tag requests the login data from the HP Universal CMDB server provided that:

- The external application server can communicate with JSP tags.
- The HP Universal CMDB server is accessible to the external application server and to the browser.

## Direct Link Operation Flow

This section describes different scenarios in which direct links are used to embed UCMDB applets into external machines.

This section includes the flow descriptions:

- ["Regular Login" below](#)
- ["An Embedded UCMDB Applet Using a Direct Link URL" on page 127](#)
- ["An Embedded UCMDB Applet Using a UCMDB Applet Tag" on page 128](#)

### **Regular Login**

This flow describes a regular login to the HP Universal CMDB server. It serves as a base reference for the direct link flows.

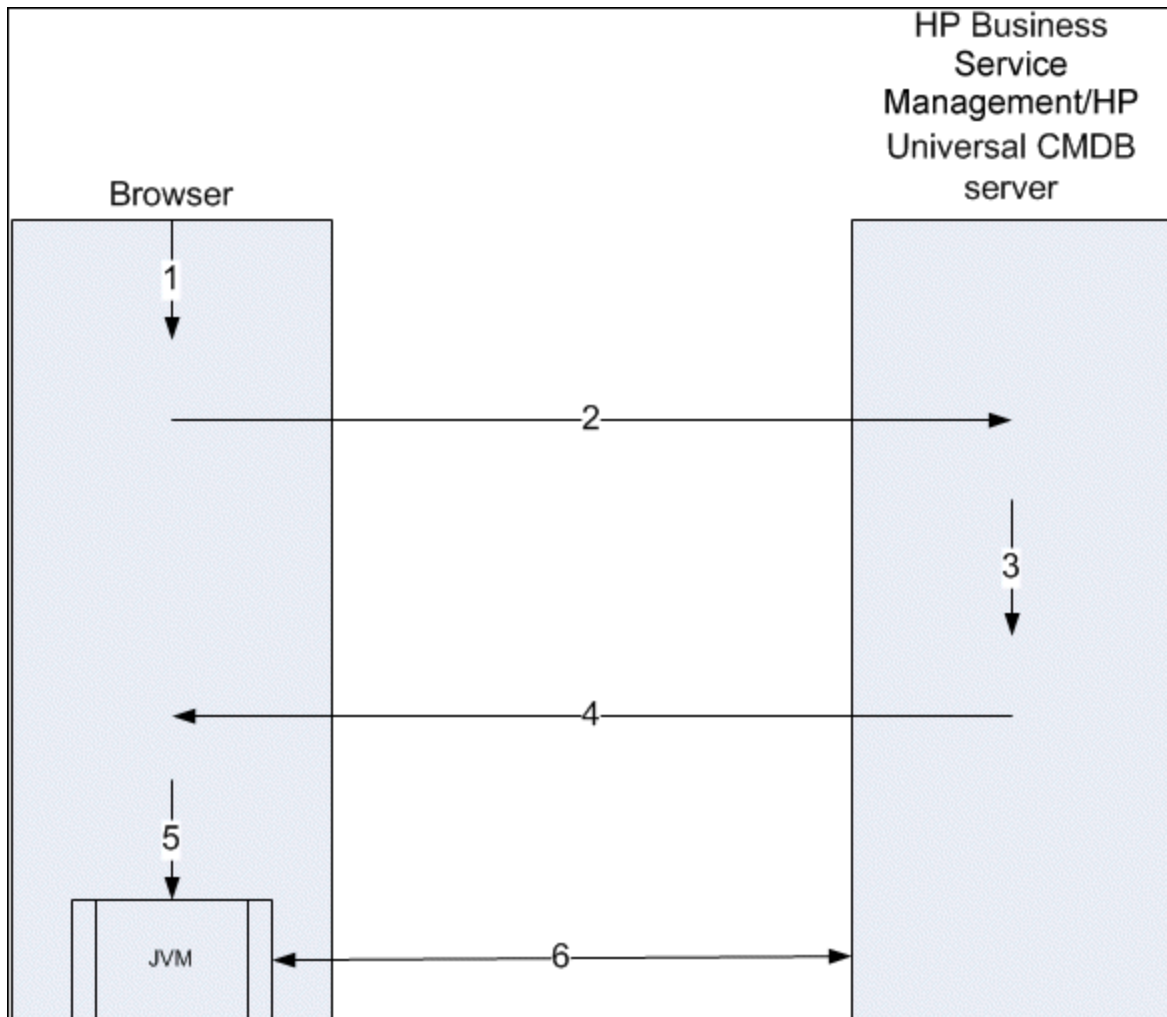

1. The user enters the direct link URL (into the browser) to log into the HP Universal CMDB server.
2. The browser sends the login request to the HP Universal CMDB server.
3. The server checks the user credentials and creates a user session if required.
4. The server returns the requested first page of HP Universal CMDB.
5. The browser loads the Java virtual machine (JVM) with the `code base` location parameter (which instructs the JVM from where to load the UCMDB applet files) as the HP Universal CMDB server.
6. UCMDB applet files (jars) and data are transferred between the HP Universal CMDB server and the JVM loaded in the browser.

At this point, the UCMDB applet is loaded and regards HP Universal CMDB as the server with which it should communicate.

### An Embedded UCMDB Applet Using a Direct Link URL

This flow shows how to use the direct link to open a UCMDB applet (opened to a specified context) in a new browser frame.

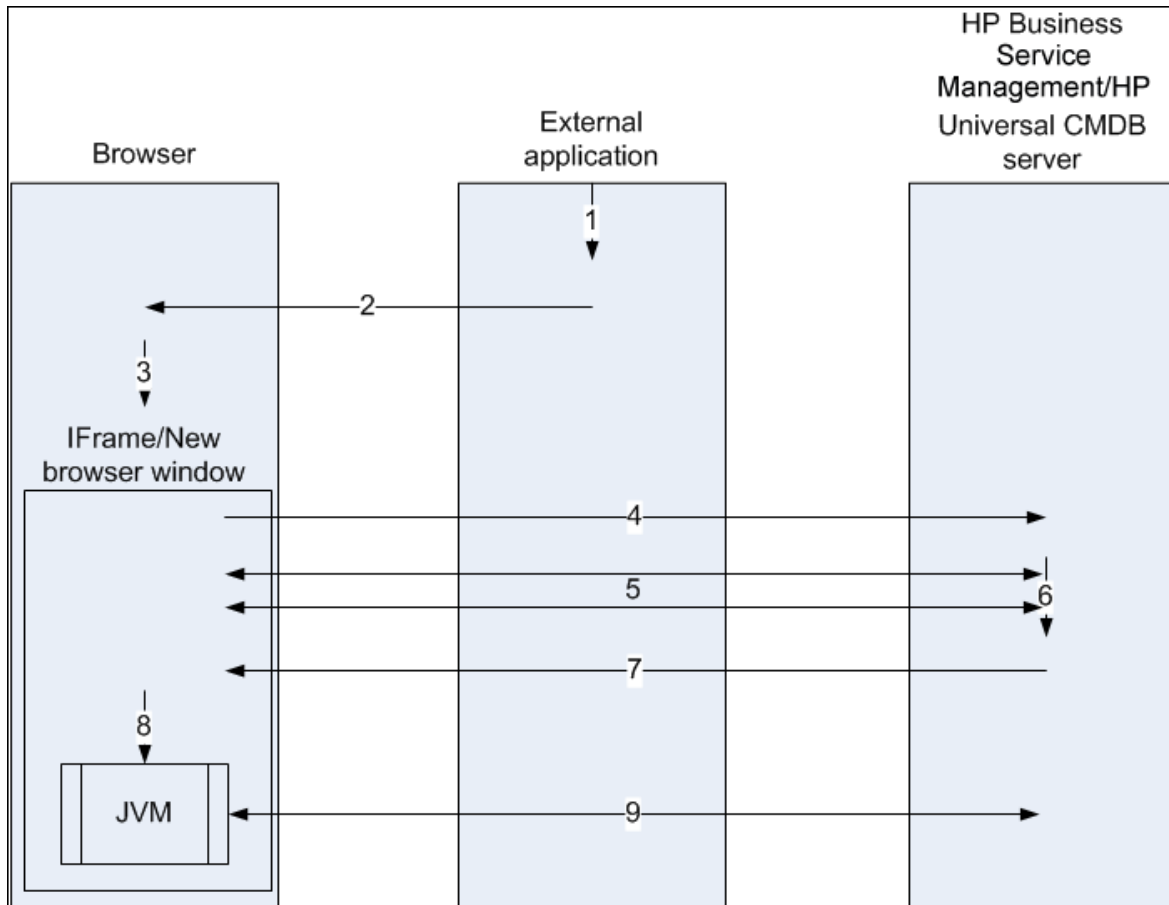

1. The external application has a page that needs to show the UCMDB applet.
2. The returned page includes a directive to open the direct link in an IFrame or new browser window.
3. The browser opens a new frame (IFrame or new window) with the direct link as the frame URL.
4. The new frame sends the direct link to the HP Universal CMDB server.
5. If the user is not already logged into HP Universal CMDB, HP Universal CMDB displays the login page and waits for the user to enter credentials and click the login button.
6. The user session is created, if required.

7. The HP Universal CMDB server returns a page that includes the directive to load the UCMDB applet.
8. The browser processes the page. When the browser encounters the directive to load the UCMDB applet, it starts the JVM. The browser then passes the needed parameters to the JVM, including the HP Universal CMDB server location as "code base."
9. UCMDB applet files (jars) and data are transferred between the HP Universal CMDB server and the JVM loaded in the browser.

**Caution:** The HP Universal CMDB server must be accessible from the browser machine.

### An Embedded UCMDB Applet Using a UCMDB Applet Tag

This flow shows how to use the UCMDB applet tag in conjunction with direct links to embed the UCMDB applet (opened to a specified context) in an external application page.

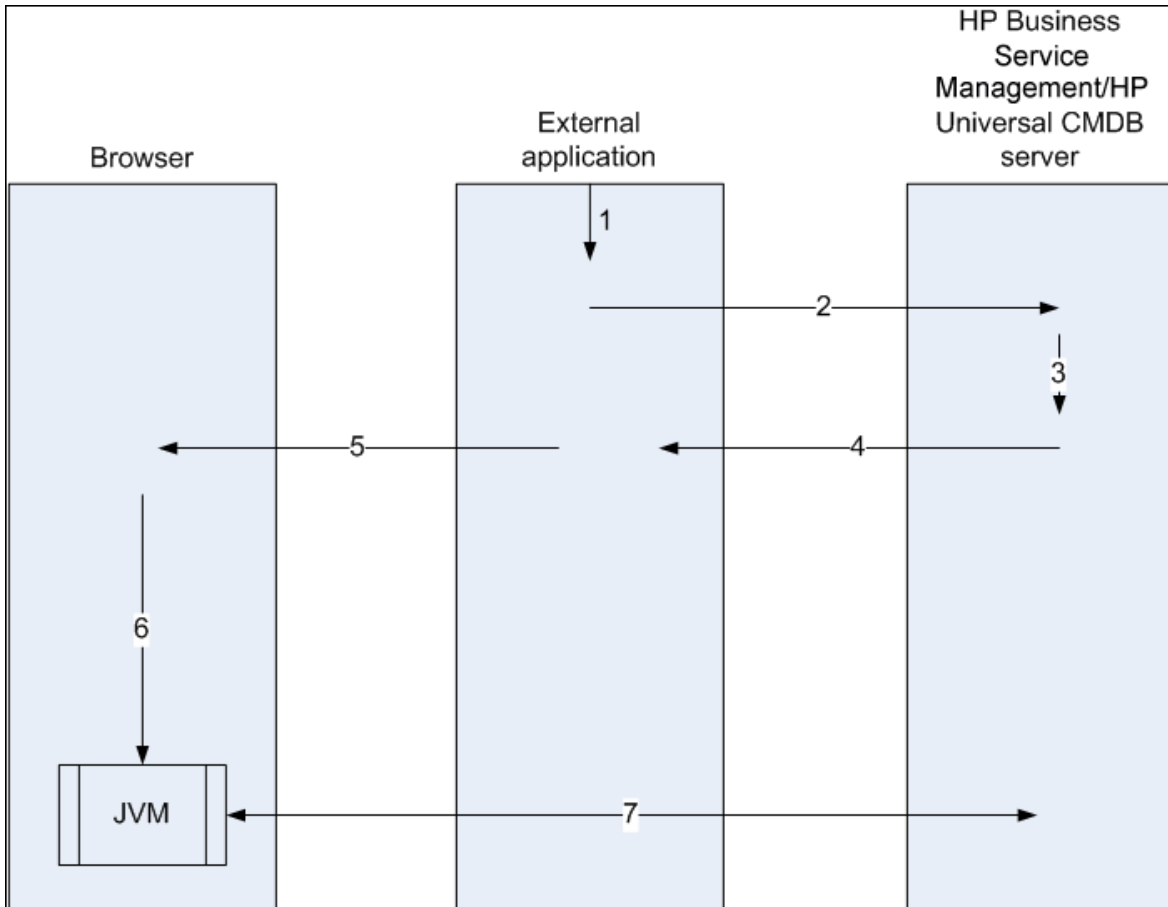



1. The UCMDB applet tag is included in the processed JSP in the external application.
2. The UCMDB applet tag uses the parameters given to it to create an HTTP/HTTPS connection to the HP Universal CMDB server and requests the applet HTML snippet code.
3. If the user is not already logged in, the parameters from the UCMDB applet tag are used (see the tag itself for reference information regarding this step). If login fails, the UCMDB applet tag returns an error message, either the preset one or the one specified in the UCMDB applet tag parameters.
4. The HP Universal CMDB server returns the HTML snippet code (with embedded Javascript) that loads the UCMDB applet. The external application can now incorporate this snippet code into the page, and send the page to the browser.
5. The external application sends the complete page that includes the HTML snippet code to the browser.
6. The browser processes the page. When the browser encounters the HTML snippet code that loads the UCMDB applet, the JVM is started. The browser then passes the needed parameters to the JVM, including the HP Universal CMDB server location as "code base".
7. UCMDB applet files (jars) and data are transferred between the HP Universal CMDB server and the JVM loaded in the browser.

**Caution:** The HP Universal CMDB server must be accessible from both the browser machine as well as the external application machine.

# Chapter 5: Working with the CI Selector

This chapter includes:

CI Selector Overview .....	130
How to Display a View in Browse Mode .....	130
How to Search for CIs in Search Mode .....	131
How to Modify CI Selector Display Options .....	132
CI Selector User Interface .....	133
Troubleshooting and Limitations – CI Selector .....	146

## CI Selector Overview

**Note:** The CI Selector was known as View Explorer in earlier versions of HP Universal CMDB.

The CI Selector presents the elements of the IT universe model in HP Universal CMDB through the medium of views. HP Universal CMDB displays the CI Selector in the left pane of IT Universe Manager and the Modeling Studio.

When you select a view in the CI Selector, the configuration items (CIs) contained in the view are displayed in a hierarchical tree format according to the relationships defined between the CIs. A view may be empty if no CIs were found matching the TQL query. For details on views, see ["View Formats" on page 255](#).

You can use the CI Selector to select views and to locate CIs. You can select a view and browse through the list of CIs, or you can search for a specific CI by name or by CI type. You can also save the search criteria for future use.

For information on the components of the CI Selector, see ["CI Selector User Interface" on page 133](#).

## How to Display a View in Browse Mode

When the CI Selector is set to **Browse** mode, you can display the contents of a selected view. For details on the CI Selector user interface in Browse mode, see ["CI Selector" on page 135](#).

This task includes the following steps:

- ["Prerequisites" below](#)
- ["Select a View to Display" below](#)

### 1. Prerequisites

In the CI Selector pane, select **Browse Views** mode.

### 2. Select a View to Display

Click the ellipsis  button to open the View Selector dialog box and select the view you want to display. The name of the selected view is shown in the **View** box. The CIs in the view appear in the CI tree in the lower part of the CI Selector pane. The view remains selected when you move to other applications in HP Universal CMDB.

## How to Search for CIs in Search Mode

The CI Selector search tool enables you to locate a specific CI. The search is executed on the entire CMDB. For details on the CI Selector search tool user interface, see ["CI Selector" on page 135](#).

This task includes the following steps:

- ["Prerequisites" below](#)
- ["Search by CI Name or Global ID" below](#)
- ["Search by Configuration Item Type" on the next page](#)
- ["Run the Search and Sort the Results" on the next page](#)
- ["Run an Advanced Search" on the next page](#)

### Prerequisites

In the CI Selector pane, select **Search CIs** mode and select the **Simple** tab.

### Search by CI Name or Global ID

To search for CIs by name, enter a string in the **CI Name** box, representing the name of the CI, or part of the name. The search returns all CIs that contain the entered string somewhere in their names (within the boundaries of the other search criteria that you define).

Alternatively, enter the global ID of a CI in the CI Name box. You need to enter the full global ID.

**Note:** The search by CI name option is not case sensitive.

## Search by Configuration Item Type

You can search for CIs using the **CI Type** box. This search returns CIs of the type specified in the **CI Type** box.

Click the ellipsis  button and select the required CI type. You cannot manually enter a CIT in the **CI Type** box.

After defining a CI in the **CI Type** box, HP Universal CMDB remembers your selection until you move to a different application, or until you define a different value.

## Run the Search and Sort the Results

Run the search. The results appear in the lower part of the CI Selector pane, showing the CI name and type for each entry. You can sort the search results by clicking the appropriate heading.

When you select a CI in the search results, the CI appears in the topology map with its related CIs in the CMDB.

Optionally, save the search criteria by clicking the **Save**  button and entering a name for the search. For details, see ["Save Search Criteria Dialog Box" on page 146](#).

## Run an Advanced Search

You can select the **Advanced** tab for other search options. For details on the CI Conditional search, see ["CI Conditional Search Dialog Box" on page 134](#). For details on the Running Software search, see ["Running Software Search Dialog Box" on page 145](#).

# How to Modify CI Selector Display Options

You can modify the display options for the CI Selector. These options are configured in the Infrastructure Settings Manager.

**Caution:** Modifying certain settings in the Infrastructure Settings Manager can adversely affect the performance of HP Universal CMDB. Do not modify settings without first consulting HP Software

Support or your HP Professional Services representative.

This task includes the following steps:

- ["Prerequisites" below](#)
- ["Modify Selected Settings" below](#)

### 1. Prerequisites

Access the Infrastructure Settings Manager by selecting **Managers > Administration > Infrastructure Settings Manager**.

### 2. Modify Selected Settings

The following settings can be modified:

- **Immediate Children Count.** Number of children immediately displayed when expanding their parent's query node in the CI Selector.
- **Maximal Children Count.** Maximum number of children displayed under their parent's query node in the CI Selector.
- **Maximal search results size.** Maximum number of CMDB instances that can be returned in one search operation.
- **Recently Used Views List size.** Maximal number of recently used views to store per user.

## CI Selector User Interface

This section includes (in alphabetical order):





CI Conditional Search Dialog Box .....	134
CI Selector .....	135
Organize Searches Dialog Box .....	144
Running Software Search Dialog Box .....	145
Save Search Criteria Dialog Box .....	146





## CI Conditional Search Dialog Box

This dialog box enables you to search for CIs by attribute conditions, by related CIs, and by attribute conditions of related CIs.

<b>To access</b>	In the CI Selector, select the <b>Advanced</b> tab in Search mode and click the ellipsis button next to CI Conditional Search.
<b>See also</b>	<a href="#">"CI Selector Overview" on page 130</a>

User interface elements are described below:

UI Element (A-Z)	Description
<b>Attribute name</b>	Select an attribute from the drop-down list.  <b>Note:</b> If you select <b>Display Label</b> from the <b>Attribute name</b> list, the operator <b>Like ignore case</b> does not appear in the <b>Operator</b> list since a <b>Display Label Like ignore case</b> condition can be added using the CI name/Related CI Name.
<b>CI Name</b>	Enter a CI name for which to search.
<b>CI Type</b>	Click the ellipsis  button to select a CI type from the tree.
<b>Integration Points</b>	If you want to run your search over federated CIs also, click the ellipsis  button to select the target integration points for the CIs.  <b>Note:</b> If you select a disconnected integration point for your search, an error message appears when the search is run, asking if you want to see local search results.
<b>Operator</b>	Select an operator from the drop-down list.
<b>Related CI Name</b>	Enter the name of a related CI for the search.
<b>Related CI Type</b>	Click the ellipsis  button to select a CI type from the tree for a search by related CI.
<b>Relationship Type</b>	Click the ellipsis  button to select a relationship from the tree for a search by related CI.

UI Element (A-Z)	Description
<b>Search by CI conditions</b>	<p>Select the check box to run a search for CIs with the specified conditions.</p> <p>Each row represents an attribute condition that you specify. Use the And/Or column and the Brackets columns to link multiple conditions. Select <b>NOT</b> if you want the condition statement to do the opposite of what is defined. In this way, you can construct a more precise logical statement to generate the required results.</p> <p> <b>Add attribute condition.</b> Adds an attribute condition row. Select the attribute name, operator, and value to define the attribute condition.</p> <p> <b>Delete selected row.</b> Deletes the selected attribute condition.</p> <p> <b>Move selected row up.</b> Moves the selected row up.</p> <p> <b>Move selected row down.</b> Moves the selected row down.</p> <p> <b>Show Criteria.</b> Displays the criteria of the selected condition in a pop-up dialog box.</p>
<b>Search by related CI conditions</b>	<p>Select to run a search for CIs related to CIs with the specified conditions.</p> <p><b>Note:</b> If you select <b>Display Label</b> from the <b>Attribute name</b> list, the operator <b>Like ignore case</b> does not appear in the <b>Operator</b> list since a <b>Display Label Like ignore case</b> condition can be added using the CI name/Related CI Name.</p>
<b>Search by related CI criteria</b>	<p>Select to run a search for CIs related to the specified CIs or CI types.</p>
<b>Value</b>	<p>Enter a value for the attribute condition.</p>

## CI Selector





This feature enables you to select views and to locate CIs.

<b>To access</b>	<p>Appears in the left pane of the IT Universe Manager page and the Modeling Studio.</p>
<b>Important information</b>	<p>The CI Selector consists of two functional formats: Browse Views mode and Search CIs mode.</p> <ul style="list-style-type: none"> <li>In Browse Views mode, you can search for and display a view, and browse through the view to locate a particular CI. You can also perform operations on the CI from a</li> </ul>







	<p>shortcut menu.</p> <ul style="list-style-type: none"> <li>In Search CIs mode you can search for one or more CIs in the CMDB by name or by CI type.</li> </ul>
<b>Relevant tasks</b>	<p><a href="#">"How to Display a View in Browse Mode" on page 130</a></p> <p><a href="#">"How to Search for CIs in Search Mode" on page 131</a></p>
<b>See also</b>	<p><a href="#">"CI Selector Overview" on page 130</a></p>

## Browse Views Mode





User interface elements are described below (unlabeled elements are shown in angle brackets>):

UI Element (A-Z)	Description
	<p><b>Refresh CIs Tree.</b> Refreshes the data content of the hierarchical tree structure that may have been modified by other users.</p>
	<p><b>Show Template Parameters.</b> Opens the Template Parameter Values dialog box, which enables you to edit the parameters of the selected template.</p> <p><b>Note:</b> This button is only active when a template is selected.</p>
	<p><b>Add selected CIs to model/view.</b> Adds the selected CIs to the current model or view.</p> <p><b>Note:</b> This button only appears in the Modeling Studio.</p>
	<p><b>Add to model as related CIs.</b> Adds the selected CI to the model as a related CI.</p> <p><b>Note:</b> This button is only active in the Model Editor of the Modeling Studio.</p>
	<p><b>Open selected model in a new tab.</b> Opens the selected model in the Model Editor.</p> <p><b>Note:</b> This button is only active when a model is selected in the Modeling Studio.</p>



UI Element (A-Z)	Description
	<p><b>Show models containing selected CI.</b> Displays a list of models containing the selected CI.</p> <p><b>Note:</b> This button only appears in the Modeling Studio.</p>
	<p>In IT Universe Manager, this represents <b>Show View Definition</b>, which takes you directly to the view definition in the Modeling Studio for the current view.</p> <p>In the Modeling Studio, this represents <b>Open selected view</b>, which opens the selected view in the Editor pane.</p>
	<p><b>Show views containing selected CI/model.</b> Displays a list of views containing the selected CI or model.</p> <p><b>Note:</b> This button only appears in the Modeling Studio.</p>
	<p><b>Generate view for selected model.</b> Opens the Creating New View dialog box which enables you to build a view based on the selected model.</p> <p><b>Note:</b> This button is only active when a model is selected in the Modeling Studio.</p>
	<p><b>Show Discovery and Changes Summary.</b> Enables you to rediscover all the CIs in a selected view by manually starting the DFM jobs that originally discovered them. For details, see "<a href="#">Show Discovery Status and Changes Dialog Box</a>" on page 250.</p> <p><b>Note:</b> This button only appears in IT Universe Manager.</p>
	<p><b>Generate Direct Link to View.</b> Enables you to create a direct link to the view using the Direct Links wizard.</p> <p><b>Note:</b> This button only appears in IT Universe Manager.</p>
	<p><b>Export Browse Results to File.</b> Enables you to export the browse results. Choose the export format from the following options:</p> <ul style="list-style-type: none"> <li>• <b>Excel.</b> The table data is formatted as an .xls (Excel) file that can</li> </ul>





UI Element (A-Z)	Description
	<p>be displayed in a spreadsheet.</p> <ul style="list-style-type: none"> <li>• <b>PDF.</b> The table data is exported in PDF format.</li> </ul> <div data-bbox="643 443 1370 711" style="background-color: #f0f0f0; padding: 10px;"> <p><b>Note:</b> When exporting CIs to PDF format, the maximum number of CIs that can be exported is approximately 20,000, depending on the amount of text associated with the exported CIs. It is also important to select a reasonable number of columns to display to ensure that the report is legible.</p> </div> <ul style="list-style-type: none"> <li>• <b>RTF.</b> The table data is exported in Rich Text Format.</li> <li>• <b>CSV.</b> The table data is formatted as a comma-separated values (CSV) text file that can be displayed in a spreadsheet.</li> </ul> <div data-bbox="643 919 1370 1226" style="background-color: #f0f0f0; padding: 10px;"> <p><b>Note:</b> For the CSV formatted table data to display correctly, the comma (,) must be defined as the list separator. In Windows, to verify or modify the list separator value, open Regional Options from the Control Panel, and on the Numbers tab ensure that the comma is defined as the List Separator value. In Linux, you can specify the list separator in the application that opens the CSV file.</p> </div> <ul style="list-style-type: none"> <li>• <b>XML.</b> The table data is formatted as an XML file which can be opened in a text or XML editor.</li> </ul> <div data-bbox="602 1362 1370 1570" style="background-color: #f0f0f0; padding: 10px;"> <p><b>Tip:</b> To extract HTML code from the report:</p> <ul style="list-style-type: none"> <li>• Open the file in an HTML editor</li> <li>• Copy the relevant table into the target file</li> </ul> </div>
	<p><b>Snapshots.</b> Enables you to work with snapshots. The following options are available:</p> <ul style="list-style-type: none"> <li>• <b>Save Snapshot.</b> Select to open the Save Snapshot dialog box, which enables you to save a snapshot of the view. For details, see <a href="#">"Save Snapshot Dialog Box" on page 249.</a></li> </ul>





UI Element (A-Z)	Description
	<ul style="list-style-type: none"> <li>• <b>Compare Snapshots.</b> Select to run the Compare Snapshots Report. For details, see "<a href="#">Compare Snapshots Report</a>" on page 395.</li> <li>• <b>Schedule Snapshot.</b> Select to open the Schedule Job dialog box. For details, see "<a href="#">Schedule Report/Snapshot Dialog Box</a>" on page 444.</li> <li>• <b>Show Scheduled Snapshot Jobs.</b> Select to open the Job List dialog box. For details, see "<a href="#">Job List Dialog Box</a>" on page 417.</li> </ul> <p><b>Note:</b> This button only appears in IT Universe Manager.</p>
	<p><b>View Based Report.</b> Displays the topology report for the selected view.</p> <p><b>Note:</b> This button only appears in IT Universe Manager.</p>
	<p><b>Asset Report.</b> Opens the Asset report for the selected view. For details, see "<a href="#">Asset Report</a>" on page 371.</p> <p><b>Note:</b> This button only appears in IT Universe Manager.</p>
	<p>Click the ellipsis button to the right of the <b>View</b> box, to open the View Selector dialog box. You can browse through the folder tree to locate the view you want to display.</p>
	<p>Enables you to move to the next or previous result of the search for the string entered in the Find box.</p>
<p><b>&lt;CIs&gt;</b></p>	<p>The CIs contained in the currently selected view.</p>
<p><b>&lt;Tooltip&gt;</b></p>	<p>Hold the cursor over a CI to display a tooltip with the relevant CI type.</p>
<p><b>Find</b></p>	<p>Enter a CI name or a portion of a CI name in the Find box to locate a CI in the CI tree.</p>
<p><b>View</b></p>	<p>The <b>View</b> box displays the currently selected view. To select a view to display, click the down arrow on the right side of the View box; this displays an abridged list of views, containing the most recently accessed views. Click the arrow at the bottom of the list to scroll through the entire list. The recently accessed views appear at the top</p>





UI Element (A-Z)	Description
	<p>of the drop-down, above the dividing line. The complete list of views appears below the line.</p> <p>Alternatively, place the cursor in the list and begin typing the view name. If the first few letters that you type match an existing entry, HP Universal CMDB completes the view name. If the names of several views begin with those letters, all matching views are displayed in the list.</p> <p><b>Note:</b> If the selected view in the View box fails to load, the value in the View box is set to the default (empty) selection.</p>



## Search CIs Mode

User interface elements are described below (unlabeled elements are shown in angle brackets>):

UI Element (A-Z)	Description
	<p><b>Show Search Results in Table.</b> Opens a separate pane with a table of the CIs in the search results.</p> <p><b>Note:</b> This button only appears in IT Universe Manager.</p>
	<p><b>Add selected CIs to model/view.</b> Adds the selected CIs to the current model or view.</p> <p><b>Note:</b> This button only appears in the Modeling Studio.</p>
	<p><b>Add to model as related CIs.</b> Adds the selected CI to the model as a related CI.</p> <p><b>Note:</b> This button is only active in the Model Editor of the Modeling Studio.</p>
	<p><b>Open selected model in a new tab.</b> Opens the selected model in the Model Editor.</p> <p><b>Note:</b> This button is only active when a model is selected in the</p>

UI Element (A-Z)	Description
	<p>Modeling Studio.</p>
	<p><b>Show models containing selected CI.</b> Displays a list of the models containing the selected CI.</p> <p><b>Note:</b> This button only appears in the Modeling Studio.</p>
	<p><b>Show views containing selected CI/model.</b> Displays a list of the views containing the selected CI or model.</p> <p><b>Note:</b> This button only appears in the Modeling Studio.</p>
	<p><b>Generate view for selected model.</b> Opens the Creating New View dialog box which enables you to build a view based on the selected model.</p> <p><b>Note:</b> This button is only active when a model is selected in the Modeling Studio.</p>
	<p><b>Export Search Results to File.</b> Enables you to export the search results. Choose the export format from the following options:</p> <ul style="list-style-type: none"> <li>• <b>Excel.</b> The table data is formatted as an .xls (Excel) file that can be displayed in a spreadsheet.</li> <li>• <b>PDF.</b> The table data is exported in PDF format.</li> </ul> <p><b>Note:</b> When exporting CIs to PDF format, the maximum number of CIs that can be exported is approximately 20,000, depending on the amount of text associated with the exported CIs. It is also important to select a reasonable number of columns to display to ensure that the report is legible.</p> <ul style="list-style-type: none"> <li>• <b>RTF.</b> The table data is exported in Rich Text Format.</li> <li>• <b>CSV.</b> The table data is formatted as a comma-separated values (CSV) text file that can be displayed in a spreadsheet.</li> </ul>

UI Element (A-Z)	Description
	<p><b>Note:</b> For the CSV formatted table data to display correctly, the comma (,) must be defined as the list separator. In Windows, to verify or modify the list separator value, open Regional Options from the Control Panel, and on the Numbers tab ensure that the comma is defined as the List Separator value. In Linux, you can specify the list separator in the application that opens the CSV file.</p> <ul style="list-style-type: none"> <li>• <b>XML.</b> The table data is formatted as an XML file that can be opened in a text or XML editor.</li> </ul> <p><b>Tip:</b> To extract HTML code from the report:</p> <ul style="list-style-type: none"> <li>◦ Open the file in an HTML editor</li> <li>◦ Copy the relevant table into the target file</li> </ul>
	<p><b>Manage the list of saved searches.</b> Opens the Organize Searches dialog box, where you can edit or delete searches from the list of saved searches.</p>
	<p><b>Collapse/Expand Search Criteria Panel.</b> Collapses or expands the search criteria area.</p>
	<p><b>Start the Search.</b> Runs the search. The search results are displayed in the lower part of the CI Selector pane.</p>
	<p><b>Save the Last Search Pattern.</b> Saves the current search criteria for future use.</p>
	<p>Enables you to move to the next or previous result of the search for the string entered in the Find field.</p>
<p><b>&lt;Search results&gt;</b></p>	<p>After you run the search, the results are listed in the lower part of the CI Selector pane. The results are shown in two columns:</p> <ul style="list-style-type: none"> <li>• <b>Name.</b> Contains the name of the CI.</li> <li>• <b>CI Type.</b> Contains the CI type of the CI.</li> </ul> <p>If the CI or view name is abbreviated, hold the pointer over the entry to see the full name. You can sort the search results by clicking the appropriate heading.</p>

UI Element (A-Z)	Description
<b>Advanced tab</b>	<p>The following detailed search options are available:</p> <ul style="list-style-type: none"> <li>• <b>CI Conditional Search.</b> Enables you to search for CIs by attribute conditions, by related CIs, and by attribute conditions of related CIs.</li> <li>• <b>Running Software Search.</b> Enables you to search for hosts by the applications running on them and for applications by the host on which they are running.</li> </ul> <p>For each of the searches, click the ellipsis  button to open the search dialog box. After running a search, click <b>Save</b>  to save the search for future use.</p>
<b>CI Name</b>	To search for a CI by name, enter the name or global ID of the CI for which to search.
<b>CI Type</b>	To search for CIs by CI type, click the ellipsis button to select a CI from the Select Configuration Item Type dialog box.
<b>Find</b>	Enter a CI name or a portion of a CI name in the Find box to locate a CI in the search results.
<b>Searches</b>	Select a search from the drop-down list of saved searches.
<b>Search results count</b>	The Search results count below the Find box displays the total number of CIs found in the search.
<b>Simple tab</b>	The Simple tab includes the standard search functionality. Click the Advanced tab for more detailed search options.

### Shortcut Menu Options

Menu Item	Description
<b>&lt;IT Universe Manager shortcut menu options&gt;</b>	The regular shortcut menu for the topology map in IT Universe Manager is also available from the CI Selector. For details on the menu options, see <a href="#">"IT Universe Manager Page" on page 230</a> .
<b>Add</b>	<p>Adds the selected CI to the current model or view.</p> <div style="background-color: #f0f0f0; padding: 5px; margin-top: 10px;"> <p><b>Note:</b> This feature only appears in the Modeling Studio.</p> </div>

Menu Item	Description
<b>Add to model as related CIs</b>	<p>Adds the selected CI as a related CI to the current model.</p> <p><b>Note:</b> This feature only appears in the Modeling Studio.</p>
<b>Generate view for selected model</b>	<p>Select to create a view based on the current model. The Creating New View dialog box opens which enables you to select a perspective to apply.</p> <p><b>Note:</b> This feature only appears in the Modeling Studio.</p>
<b>Open selected model in a new tab</b>	<p>Opens the selected model in a new tab in the Model Editor.</p> <p><b>Note:</b> This feature only appears in the Modeling Studio.</p>
<b>Show containing models</b>	<p>Select <b>Show models containing selected CI</b> to display a list of the models containing the selected CI.</p> <p><b>Note:</b> This option only appears in the Modeling Studio.</p>
<b>Show containing views</b>	<p>Select <b>Show views containing selected CI/model</b> to display a list of the views containing the selected CI or model.</p> <p><b>Note:</b> This option only appears in the Modeling Studio.</p>

## Organize Searches Dialog Box



This dialog box enables you to edit or delete searches from the list of saved searches.

<b>To access</b>	Click the <b>Manage the list of saved searches</b>  button in the CI Selector.
<b>See also</b>	<a href="#">"CI Selector Overview" on page 130</a>

User interface elements are described below:

UI Element (A-Z)	Description
	Click to edit the selected search. For simple searches, the CI Simple Search dialog box opens, which enables you to edit the name and type of the CI. For CI Conditional



UI Element (A-Z)	Description
	searches, the CI Conditional Search dialog box opens.
	Click to delete the selected search.
	Click to expand the search tree.
	Click to collapse the search tree.
<Searches tree>	Displays all the saved searches in tree format.
Find	Enter a search name or a portion of a search name in the Find box to locate it in the list.
Find Next	Click to go to the next occurrence of the selected search phrase in the list.
Find Previous	Click to go to the previous occurrence of the selected search phrase in the list.

## Running Software Search Dialog Box

This dialog box enables you to search for hosts by the applications running on them and to search for applications by the host on which they are running.

<b>To access</b>	In the CI Selector, select the <b>Advanced</b> tab in Search mode and click the ellipsis button next to Running Software Search.
<b>See also</b>	<a href="#">"CI Selector Overview" on page 130</a>

User interface elements are described below:

UI Element (A-Z)	Description
<b>Host name</b>	Enter the name of the node for which you are searching.
<b>Running Software</b>	Select a running software CI from the drop-down list.  <b>Note:</b> The drop-down list may not display an accurate list of available running

UI Element (A-Z)	Description
	software CI types (only the option <b>Any</b> appears). In this event, perform the Host name search only.
<b>Search for</b>	Select <b>Running Software</b> or <b>Node</b> .  <b>Note:</b> To search for a running software CI running on a specific node, enter a node name, select the required running software CI and click <b>Search</b> to search for it.

## Save Search Criteria Dialog Box

This dialog box enables you to save the current search criteria for future use.

<b>To access</b>	Click <b>Save</b>  from Search mode in the CI Selector.
<b>See also</b>	<a href="#">"CI Selector Overview" on page 130</a>

User interface elements are described below:

UI Element (A-Z)	Description
<b>Existing Queries</b>	Displays a list of existing searches in tree format.
<b>Name</b>	Enter a name for the current search.
<b>Find</b>	Enter a search name or a portion of a search name in the Find box to locate it in the list.
<b>Find Next</b>	Click to go to the next occurrence of the selected search phrase in the list.
<b>Find Previous</b>	Click to go to the previous occurrence of the selected search phrase in the list.

## Troubleshooting and Limitations – CI Selector

This section describes troubleshooting and limitations for the CI Selector.

## Unavailable Views and CIs

The View list in the CI Selector may not display all views in the CMDB, or it may not display the contents of a view, for any of the following reasons:

- The View list includes only the views for which you have the necessary permissions. Similarly, Search mode is only available if you have the **Allow Search** general action permission. To set permissions, select **Managers > Administration > Roles Manager**. For more information, see Roles Manager in the *HP Universal CMDB Administration Guide*.
- Views that are currently inactive appear in red in the View list, but they cannot be selected. In IT Universe Manager, inactive views appear in faded text.
- Out-of-the-box views for which you do not have a license may appear in the View list, but these views do not contain CIs. For information on the out-of-the-box views, see "[Predefined Folders and Views](#)" on page 260.

**Note:** After deleting one or more query nodes from a TQL query, it can take time for changes to be updated to the view; meanwhile, the removed CIs appear in the view. If you select one of these CIs before it is updated, an error message is displayed. Click the **Refresh** button to update the view.

# Chapter 6: Working with the Topology Map

This chapter includes:

Topology Map Overview .....	148
Handling Large Views .....	149
Topology Map User Interface .....	149

## Topology Map Overview

The Topology Map provides a graphical display of a view. All the CIs in a given layer of the view are represented by icons and the connecting lines represent relationships. You can select a CI in the Topology Map or in the CI Selector in the left pane. You can also drill down in the CI Selector to display different layers of the view in the Topology Map.

The label of a CI appears under the icon. You can set the maximum number of characters per line and the maximum number of lines in a CI label in the User Preferences dialog box under **General**. For details, see ["User Preferences Dialog Box" on page 93](#).

A CI that has an additional CI layer beneath it, created by the hierarchy set for the view, appears with a downward arrow icon in the Topology Map, as well as a count indicator displaying the total number of CIs in all of the sublayers under it. You can click the arrow to display the CIs contained in the sublayer.



When you hold the pointer over the CI icon, a tooltip displays the CI's details. When you hold the pointer of the count indicator, a tooltip displays a breakdown of the CIs beneath that CI by CI type.

The topology map is automatically updated dynamically with changes in the IT Universe data, such as new CIs discovered by the Data Flow Management process.

The toolbar and Main Menu above the Topology Map enable you to zoom in, change the layout of the Topology Map, and print the Topology Map. Additional functionality is available from the shortcut menu by right-clicking a CI in the Topology Map or in the CI Selector.

## Handling Large Views

The Topology Map cannot display a view with more than 900 CIs in a single layer. When you select a view which contains a layer with more than this number of CIs, the Topology Map appears empty. A layer with more than 900 CIs can be displayed in a table in Text mode.

To display large views in the Topology Map, use one of the following methods:

- Reduce the TQL query results by redefining the view in the Modeling Studio. For details, see "[Change Query Node/Relationship Type Dialog Box](#)" on page 290.
- Define a different hierarchy for the view to redistribute the CIs among the view's layers. For details on defining hierarchy, see "[Setting the View Hierarchy](#)" on page 257.
- Reset the maximum number of CIs allowed in the configuration parameters. Select the **Max Object Count GUI for TS** parameter under **Visualization Settings** in the Infrastructure Settings Manager. However, be aware that increasing the maximum number of CIs per layer may significantly slow down the redrawing of the Topology Map.

For details regarding Infrastructure Settings Manager, see "Infrastructure Settings Manager User Interface" in the *HP Universal CMDB Administration Guide*.

## Topology Map User Interface

This section includes (in alphabetical order):

Export Map to Image Dialog Box .....	150
Layout Properties Dialog Box .....	150
Main Menu .....	164
Print Dialog Box .....	165
Print Preview Dialog Box .....	166
Print Setup Dialog Box .....	166
Toolbar Options .....	168
Topology Map Sidebar .....	176

## Export Map to Image Dialog Box

This dialog box enables you to save a topology map to a file.

<b>To access</b>	From a topology map, select <b>Operations &gt; Export Map to Image</b> .
<b>Relevant tasks</b>	<a href="#">"How to Print and Save a Topology Map to File" on page 213</a>
<b>See also</b>	<ul style="list-style-type: none"> <li>• <a href="#">"Topology Map Overview" on page 148</a></li> <li>• <a href="#">"Topology Map User Interface" on the previous page</a></li> </ul>

User interface elements are described below:

UI Element (A-Z)	Description
<b>Actual Size</b>	Save the view so that the graph node sizes are at maximum.
<b>Current Zoom Level</b>	Save the view as you see it on the topology map. For example, if you have used the <b>Interactive Zoom</b> mode to decrease the view magnification, the graph nodes also appear smaller in the saved view. For details, see <a href="#">"Interactive Zoom" on page 171</a> .
<b>Custom</b>	Specify the size of the view you want to save in the <b>Width</b> and <b>Height</b> boxes.
<b>File Name</b>	Specify the required file name and location (or click <b>Browse</b> to search for the file and location).
<b>Fit in Canvas</b>	Expand or shrink the view so that it fits in the pane.
<b>Image Quality</b>	The quality of the printed map. Select <b>High</b> , <b>Medium</b> , or <b>Low</b> .
<b>Selected Objects Only</b>	Saves only the graph nodes/CIs and their relationships that you selected in the map.
<b>Type</b>	Select the required file format.
<b>Visible Window Only</b>	Saves only the part of the graph that appears in the pane.

## Layout Properties Dialog Box

This dialog box enables you to customize the layout of a specific layer in a view, to achieve the clearest presentation possible and to better understand and monitor the managed data.

<b>To access</b>	Select <b>Layout &gt; Layout Properties</b> .
<b>Important information</b>	<p>You define the layout of a view's layers by assigning logical positions for the graph's nodes and relationships that appear in a layer. You customize the layer layouts by modifying the default values.</p> <p>You set layout definitions for a specific layer only. The definitions cannot be saved for a different layer or a different view.</p> <p>Parameter values are in pixels.</p>
<b>See also</b>	<ul style="list-style-type: none"> <li>• <a href="#">"Topology Map Overview" on page 148</a></li> <li>• <a href="#">"Topology Map User Interface" on page 149</a></li> </ul>

## Global Tab

This area enables you to define global layout parameters.

<b>To access</b>	Click the <b>Global</b> tab in the Layout Properties dialog box.
<b>Important information</b>	The Global tab enables you to define global settings for the layout.

User interface elements are described below:

<b>UI Element (A-Z)</b>	<b>Description</b>
<b>Drawing Fitting</b>	<p>Select one of the following options for fitting the layout:</p> <ul style="list-style-type: none"> <li>• <b>Fit to Canvas.</b> Fit the layout to the canvas on the screen.</li> <li>• <b>Fit for Printing.</b> Fit the layout to a page for printing.</li> <li>• <b>No Fitting.</b> Do not change the layout.</li> </ul>
<b>Labeling</b>	Select <b>Perform Labeling</b> to ensure that the labels appear when the layout is redrawn. If this field is not selected, labels do not appear in the redrawn layout.
<b>Style</b>	Select <b>Apply Style Deeply</b> to apply the layout selected to all nested layers of the topology map.

## All Styles Tab

<b>To access</b>	Click the <b>All Styles</b> tab in the Layout Properties dialog box.
------------------	--

**Important information**

The All Styles tab enables you to define general layout parameters for disconnected graph nodes and connected components.

- A disconnected graph node is a node that is not connected to any other graph node.
- A disconnected component is a component that is not connected to any other component. It contains a set of graph nodes that can be connected to each other.

This illustrates a connected component with five graph nodes:

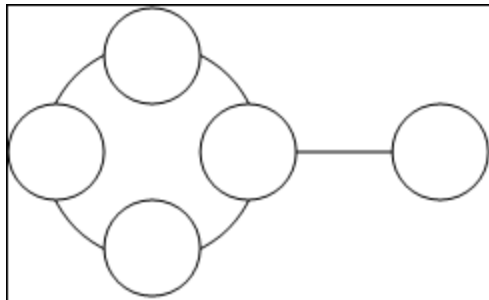

This illustrates a connected component with two graph nodes:

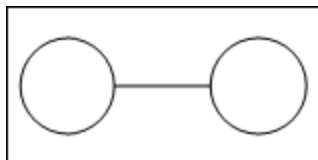

This illustrates four disconnected components, each made up of a single, disconnected graph node:

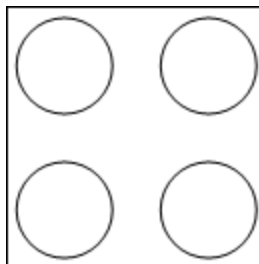

User interface elements are described below:

<b>UI Element (A-Z)</b>	<b>Description</b>
<b>Components</b>	The spacing between the components in a disconnected graph consists of both a constant value and a proportional value based on the sizes of the components.





UI Element (A-Z)	Description
	<p>Select <b>Detect Components</b> to view the disconnected components. You can specify that all components be laid out together or individually, regardless of the other components. If the grouping for components is selected, each component is laid out, and the resulting components are packed together.</p> <p>When Detect Components is selected, enter values for the following settings:</p> <ul style="list-style-type: none"> <li>• <b>Constant Spacing.</b> Set constant spacing (horizontal and vertical) around each disconnected component. <b>Default value:</b> 20</li> <li>• <b>Proportional Spacing.</b> Set spacing (horizontal and vertical) that is proportional to the size of the component around each disconnected component. <b>Default value:</b> 0.05</li> </ul>
<b>Disconnected Graph Nodes</b>	<p>The spacing between the graph nodes in a disconnected graph consists of both a constant value and a proportional value based on the sizes of the graph nodes.</p> <p>Select <b>Detect Disconnected Graph Nodes</b> to view the disconnected graph nodes. You can specify that disconnected graph nodes be grouped into one component or laid out individually.</p> <p>When Detect Disconnected Graph Nodes is selected, enter values for the following settings:</p> <ul style="list-style-type: none"> <li>• <b>Constant Spacing.</b> Set constant spacing (horizontal and vertical) around each disconnected graph node. <b>Default value:</b> 20</li> <li>• <b>Proportional Spacing.</b> Set spacing (horizontal and vertical) that is proportional to the size of the component around each disconnected graph node. <b>Default value:</b> 0.05</li> </ul>
<b>Margin Spacing</b>	Enter values for the right, left, top, and bottom margin spacing for the layout.

## Circular Tab

<b>To access</b>	Click the <b>Circular</b> tab in the Layout Properties dialog box.
<b>Important information</b>	The Circular tab enables you to group a graph's nodes into groups or clusters based on the grouping options you select. It is particularly suited for visualizing ring and star network topologies, and for link analysis.

User interface elements are described below:

UI Element (A-Z)	Description
<b>Clustering</b>	<p>Set the values for the following settings:</p> <ul style="list-style-type: none"> <li>• <b>Cluster Size Factor.</b> Specifies the ratio between the average cluster size and the number of clusters. The size of a cluster is defined as the sum of the weights of all graph nodes in the cluster. You can assign a weight value to each graph node.</li> <li>• <b>Min Number of Clusters.</b> The minimum number of clusters in a layer.</li> <li>• <b>Max Number of Clusters.</b> The maximum number of clusters in a layer.</li> </ul>
<b>Cluster Layout Style</b>	<p>Displays clusters either in a symmetric or circular layout style.</p> <p>Select one of the following options:</p> <ul style="list-style-type: none"> <li>• <b>Symmetric.</b> Displays clusters in a symmetric layout style.</li> </ul> <div data-bbox="404 957 906 1218" data-label="Diagram"> <p>The diagram shows a network graph with several clusters of nodes. The clusters are arranged in a roughly horizontal line, with some clusters branching off to the top and bottom, creating a symmetric appearance.</p> </div> <ul style="list-style-type: none"> <li>• <b>Circular.</b> Displays clusters in a circular layout style.</li> </ul> <div data-bbox="404 1318 701 1614" data-label="Diagram"> <p>The diagram shows a network graph with several clusters of nodes. The clusters are arranged in a circular pattern, with lines connecting them to form a roughly circular shape.</p> </div>
<b>Layout Quality</b>	<p>Adjusts the quality of the layout produced to fit your application's needs. The quality reflects the number of steps or the method used to produce the layout. For example, high quality is sharper but takes more time to set the layout.</p> <p>Select one of the following options:</p>

<b>UI Element (A-Z)</b>	<b>Description</b>
	<ul style="list-style-type: none"> <li>• <b>Draft.</b> Produces faster results (faster than Medium and Proof).</li> </ul>  <ul style="list-style-type: none"> <li>• <b>Medium.</b> Produces a result that is a combination of Draft and Proof, that is, it produces a more accurate graph layout than Draft, but not as accurate as Proof.</li> <li>• <b>Proof.</b> Produces a more refined result but takes more time.</li> </ul>  <div style="background-color: #f0f0f0; padding: 10px; margin-top: 10px;"> <p><b>Note:</b> The differences between the speed and resulting layout of each quality setting varies depending on the nature of the graph being laid out. You can try each option to determine which works best for you.</p> </div>
<b>Spacing</b>	<p>Sets the spacing around each graph node within the same cluster and between clusters.</p> <p>Enter values for the following settings:</p> <ul style="list-style-type: none"> <li>• <b>Between Graph Nodes.</b> Sets the spacing around each graph node within the same cluster. The larger the spacing, the more graph nodes there are on the cluster boundary.</li> </ul> <p><b>Default value:</b> 50</p> <p>This illustration shows smaller graph node spacing:</p>

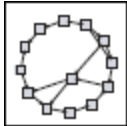
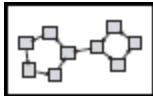
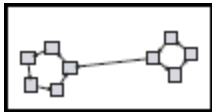
UI Element (A-Z)	Description
	 <p>This illustration shows larger graph node spacing:</p>  <ul style="list-style-type: none"> <li>• <b>Between Clusters.</b> Sets the spacing between clusters.</li> </ul> <p><b>Default value:</b> 50</p> <p>This illustration shows smaller cluster spacing:</p>  <p>This illustration shows larger cluster spacing:</p> 

### Hierarchical Tab

<b>To access</b>	Click the <b>Hierarchical</b> tab in the Layout Properties dialog box.
<b>Important information</b>	The Hierarchical tab shows the precedence relationships that can represent organizational or information management system dependencies, as well as process models, software call graphs, and work flows. The hierarchical layout emphasizes dependencies by placing the graph nodes at different levels.

User interface elements are described below:

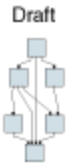
UI Element (A-Z)	Description
<b>Backward Edges</b>	<p>Specifies how backward relationships are displayed in the hierarchical layout.</p> <p>Select one of the following options:</p> <ul style="list-style-type: none"> <li>• <b>Minimize Backward Edges.</b> Sets the number of backward relationships displayed in a layer to a minimum.</li> <li>• <b>Optimize for Feedback Flow.</b> Sets the number of backward relationships displayed in a layer to a maximum. This mode is more appropriate for flow charts.</li> </ul>
<b>Horizontal Spacing</b>	<p>Enables you to set the minimum horizontal distance between two neighboring graph nodes at each level.</p> <p>Enter values for the following settings:</p> <ul style="list-style-type: none"> <li>• <b>Between Graph Nodes.</b> Sets a horizontal space around each graph node in the layer. <b>Default value:</b> 28</li> <li>• <b>Between Edges.</b> This setting is available only when you select <b>Routing &gt; Orthogonal</b>. It sets a horizontal space between edges in the graph. <b>Default value:</b> 12</li> </ul>
<b>Layout Quality</b>	<p>Adjusts the quality of the layout produced to fit your application's needs. The quality reflects the number of steps or the method used to produce the layout. For example, high quality is sharper but takes more time to set the layout.</p> <p>Select one of the following options:</p> <ul style="list-style-type: none"> <li>• <b>Draft.</b> Produces faster results (faster than Medium and Proof).</li> </ul> <div data-bbox="435 1367 500 1528" style="text-align: center;"> <p>Draft</p>  </div> <ul style="list-style-type: none"> <li>• <b>Medium.</b> Produces a result that is a combination of Draft and Proof, that is, it produces a more accurate graph layout than Draft, but not as accurate as Proof.</li> <li>• <b>Proof.</b> Produces a more refined result but takes more time.</li> </ul>

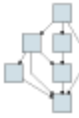
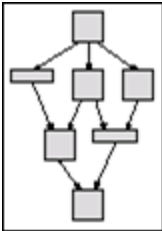
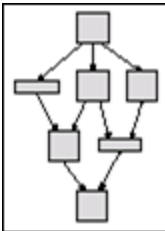
UI Element (A-Z)	Description
	 <p><b>Note:</b> The differences between the speed and resulting layout of each quality setting varies depending on the nature of the graph being laid out. You can try each option to determine which works best for you.</p>
<p><b>Level Alignment</b></p>	<p>Enables you to set the way graph nodes are vertically aligned.</p> <p>Select one of the following options:</p> <ul style="list-style-type: none"> <li> <p><b>Top.</b> This illustration shows that the top of the graph nodes at the same level of the hierarchy are aligned:</p>  </li> <li> <p><b>Center.</b> This illustration shows that the center of the graph nodes at the same level of the hierarchy are aligned:</p>  </li> <li> <p><b>Bottom.</b> This illustration shows that the bottom of the graph nodes at the same level of the hierarchy are aligned:</p> </li> </ul>

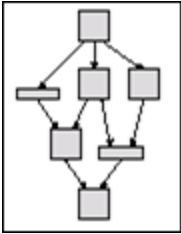
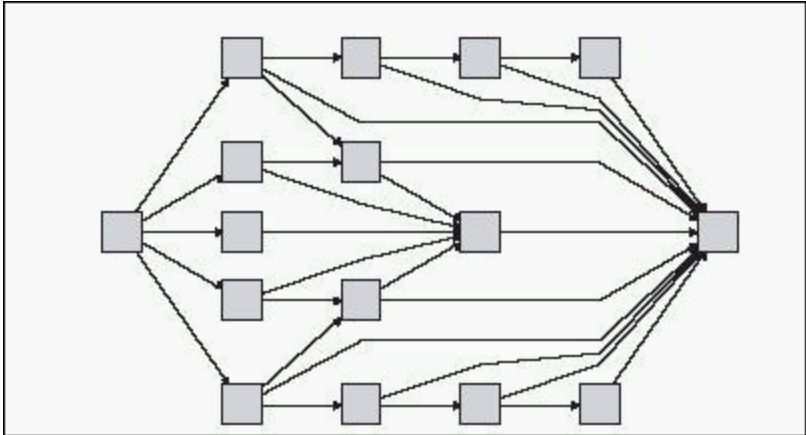
UI Element (A-Z)	Description
	
<p><b>Orientation</b></p>	<p>Enables you to set the orientation of the hierarchy.</p> <p>Select one of the following options:</p> <ul style="list-style-type: none"> <li>• <b>Top to Bottom.</b> The children are located above the parent.</li> <li>• <b>Left to Right.</b> The children are located to the left of the parent.</li> <li>• <b>Bottom to Top.</b> The children are located below the parent.</li> <li>• <b>Right to Left.</b> The children are located to the right of the parent.</li> </ul>
<p><b>Orthogonal Routing - Fix Node Sizes</b></p>	<p>This setting is available only when you select <b>Routing &gt; Orthogonal</b>. Maintain the size of a graph node. Clear this option if you want the layout to increase the size of a graph node, if it is necessary to maintain the specified relationship spacing, when more than one relationship is attached to the same side of the graph node.</p>
<p><b>Polyline Routing - Spacing Between Bends</b></p>	<p>This setting is available only when you select <b>Routing &gt; Polyline</b>. Polyline routing routes edges (connecting lines) as one or more straight line segments with arbitrary angles. Path nodes are added automatically to prevent the edges (connecting lines) from overlapping.</p> <p><b>Default Value: 12</b></p> 

UI Element (A-Z)	Description
<b>Routing</b>	Select the type of routing for the layout. The available options are: <ul style="list-style-type: none"> <li>• <b>Orthogonal</b></li> <li>• <b>Polyline</b></li> </ul>
<b>Undirected Layout</b>	Edge direction is not used to build the levels of the hierarchical drawing.
<b>Variable Level Spacing</b>	Variable level spacing adjusts the spacing between pairs of neighboring levels according to the density of edges between the levels.  If the drawing's edges are orthogonally routed, this ensures the desired vertical spacing between horizontal edges (in a top-to-bottom or bottom-to-top layout) routed between levels.  If the routing is polyline, variable level spacing makes it easier to distinguish among edges in very dense drawings.
<b>Vertical Spacing</b>	Enables you to set the minimum vertical distance between two neighboring graph nodes on different levels.  Enter values for the following settings: <ul style="list-style-type: none"> <li>• <b>Between Graph Nodes.</b> Sets a vertical space around each graph node in the level. <b>Default value: 28</b></li> <li>• <b>Between Edges.</b> This setting is available only when you select <b>Routing &gt; Orthogonal</b>. It sets a vertical space between edges in the graph. <b>Default value: 12</b></li> </ul>

## Orthogonal Tab

<b>To access</b>	Click the <b>Orthogonal</b> tab in the Layout Properties dialog box.
<b>Important information</b>	The Orthogonal tab enables you to set orthogonal layout route relationships horizontally and vertically. This results in relationships bending at 90-degree angles only.

User interface elements are described below:





UI Element (A-Z)	Description
<b>Fix Node Sizes</b>	Maintain the size of a graph node. Clear this option if you want the layout to increase the size of a graph node if it is necessary to maintain the specified relationship spacing when more than one relationship is attached to the same side of the graph node.
<b>Horizontal Spacing</b>	<p>Enables you to set the minimum horizontal distance between graph nodes.</p> <p>Select one of the following options:</p> <ul style="list-style-type: none"> <li>• <b>Between Graph Nodes.</b> Set a horizontal space around each graph node in the layer. <b>Default value:</b> 20</li> <li>• <b>Between Edges.</b> Set a horizontal space between elements in the layer. <b>Default value:</b> 12</li> </ul>
<b>Layout Quality</b>	<p>Adjusts the quality of the layout produced to fit your application's needs. The quality reflects the number of steps or the method used to produce the layout. For example, high quality is sharper but takes more time to set the layout.</p> <p>Select one of the following options:</p> <ul style="list-style-type: none"> <li>• <b>Draft.</b> Set the layout to draft quality.</li> <li>• <b>Medium.</b> Set the layout to medium quality.</li> <li>• <b>Proof.</b> Set the layout to proof quality.</li> </ul>
<b>Vertical Spacing</b>	<p>Enables you to set the minimum vertical distance between graph nodes.</p> <p>Select one of the following options:</p> <ul style="list-style-type: none"> <li>• <b>Between Graph Nodes.</b> Set a vertical space around each graph node in the layer. <b>Default value:</b> 100</li> <li>• <b>Between Edges.</b> Set a vertical space between elements in the layer. <b>Default value:</b> 20</li> </ul>

### Symmetric Tab

<b>To access</b>	Click the <b>Symmetric</b> tab in the Layout Properties dialog box.
------------------	---

<b>Important information</b>	The Symmetric tab displays a clear representation of complex networks. The symmetric layout emphasizes the symmetries that may occur in a graph.
------------------------------	--

User interface elements are described below:

<b>UI Element (A-Z)</b>	<b>Description</b>
<b>Layout Quality</b>	<p>Adjusts the quality of the layout produced to fit your application's needs. The quality reflects the number of steps or the method used to produce the layout. For example, high quality is sharper but takes more time to set the layout.</p> <p>Select one of the following options:</p> <ul style="list-style-type: none"> <li>• <b>Draft.</b> Produces faster results (faster than Medium and Proof).</li> </ul>  <ul style="list-style-type: none"> <li>• <b>Medium.</b> Produces a result that is a combination of Draft and Proof, that is, it produces a more accurate graph layout than Draft, but not as accurate as Proof.</li> <li>• <b>Proof.</b> Produces a more refined result but takes more time.</li> </ul>  <div style="background-color: #f0f0f0; padding: 10px; margin-top: 10px;"> <p><b>Note:</b> The differences between the speed and resulting layout of each quality setting varies depending on the nature of the graph being laid out. You can try each option to determine which works best for you.</p> </div>
<b>Spacing</b>	<p>Allows you to set constant horizontal and vertical spacing around each graph node in the layer. The value you specify is a guideline for the layout, so that it is possible that the spacing for a particular pair of graph nodes might be different from the one you specified. The larger the graph node spacing, the farther apart the graph nodes are spaced in the final layout.</p> <p><b>Default value:</b> 50</p> <p>The following figure illustrates smaller and larger spacing:</p>

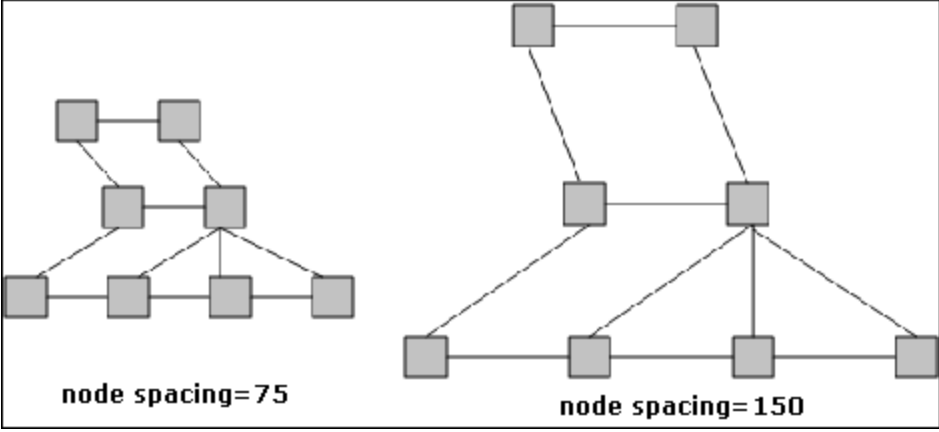
UI Element (A-Z)	Description
	

### Routing Tab

<b>To access</b>	Click the <b>Routing</b> tab in the Layout Properties dialog box.
<b>Important information</b>	The Routing tab enables you to produce drawings that leave graph nodes essentially where they are, and reroute the lines orthogonally.

User interface elements are described below:

UI Element (A-Z)	Description
<b>Fix Node Positions</b>	Maintain the position of all the graph nodes in the display. Clear this option for the layout to move the graph nodes if it is necessary to improve the layout. The movement is minimal, avoids overlaps, and minimizes bend points.
<b>Fix Node Sizes</b>	Maintain the size of a graph node. Clear this option if you want the layout to increase the size of a graph node if it is necessary to maintain the specified relationship spacing when more than one relationship is attached to the same side of the graph node.
<b>Horizontal Spacing</b>	Enables you to set the minimum horizontal distance between graph nodes. Select one of the following options: <ul style="list-style-type: none"> <li>• <b>Between Graph Nodes.</b> Set a horizontal space around each graph node in the layer.</li> </ul>

UI Element (A-Z)	Description
	<p><b>Default value:</b> 20</p> <ul style="list-style-type: none"> <li>• <b>Between Edges.</b> Set a horizontal space between elements in the layer.</li> </ul> <p><b>Default value:</b> 12</p>
<b>Vertical Spacing</b>	<p>Enables you to set the minimum vertical distance between graph nodes.</p> <p>Select one of the following options:</p> <ul style="list-style-type: none"> <li>• <b>Between Graph Nodes.</b> Set a vertical space around each graph node in the layer.</li> </ul> <p><b>Default value:</b> 20</p> <ul style="list-style-type: none"> <li>• <b>Between Edges.</b> Set a vertical space between elements in the layer.</li> </ul> <p><b>Default value:</b> 12</p>

## Main Menu

This feature contains the options for working with the topology map.

<b>To access</b>	Located in the upper left portion of the screen.
<b>Important information</b>	The specific options contained within the Main Menu drop-downs are detailed in <a href="#">"Toolbar Options" on page 168</a> .
<b>See also</b>	<ul style="list-style-type: none"> <li>• <a href="#">"Topology Map Overview" on page 148</a></li> <li>• <a href="#">"Topology Map User Interface" on page 149</a></li> </ul>

User interface elements are described below:

UI Element (A-Z)	Description
<b>Edit</b>	Contains selection options for the topology map.
<b>Editor Item</b>	<p>Contains the topology map shortcut menu options for the current manager.</p> <p><b>Note:</b> This drop-down does not appear in CI Type Manager.</p>

UI Element (A-Z)	Description
<b>Layout</b>	Contains options for changing the layout of the topology map.  <b>Note:</b> This drop-down does not appear in Reports.
<b>Managers</b>	Contains links to the different UCMDB modules.
<b>Operations</b>	Contains options for printing or exporting the topology map.
<b>Resources</b>	Contains the left pane shortcut menu options for the current manager.  <b>Note:</b> This drop-down does not appear in IT Universe Manager or Reports, and in CI Type Manager it is called <b>CI Types</b> .
<b>Tools</b>	Contains the User Preferences, User Profile, Log Configuration, Screen Capture, and Refresh User Authentication tools.
<b>View</b>	Enables you to hide or display the different panes of the module.

## Print Dialog Box

This dialog box enables you to print the contents of the topology map.

<b>To access</b>	Select <b>Operations &gt; Print</b> .
<b>Important information</b>	<p>The results of printing a topology map is similar to a screen capture. Therefore, before printing, it is recommended to:</p> <ul style="list-style-type: none"> <li>Define your print settings and arrange the contents of the topology map according to your requirements. For details, see <a href="#">"Print Setup Dialog Box" on the next page</a>.</li> <li>Arrange the contents of the topology map for print. You can use the <b>Layout</b> option and <b>Layout Properties</b>. For details about the layout options, see <a href="#">"Layout Properties" on page 172</a>. For details about layout properties, see <a href="#">"Layout Properties Dialog Box" on page 150</a>.</li> </ul>
<b>Relevant tasks</b>	<a href="#">"How to Print and Save a Topology Map to File" on page 213</a>
<b>See also</b>	<ul style="list-style-type: none"> <li><a href="#">"Topology Map Overview" on page 148</a></li> <li><a href="#">"Topology Map User Interface" on page 149</a></li> </ul>

User interface elements are described below:





UI Element (A-Z)	Description
<b>Number of copies</b>	Enter the number of copies you want to print.
<b>Properties</b>	Define document properties as required.

## Print Preview Dialog Box

This dialog box enables you to preview the content of the topology map before printing.

<b>To access</b>	Select <b>Operations &gt; Print Preview</b> .
<b>Relevant tasks</b>	<a href="#">"How to Print and Save a Topology Map to File" on page 213</a>
<b>See also</b>	<ul style="list-style-type: none"> <li>• <a href="#">"Topology Map Overview" on page 148</a></li> <li>• <a href="#">"Topology Map User Interface" on page 149</a></li> </ul>

User interface elements are described below:

Menu Item	Description
	<b>Print Setup.</b> Opens the Print Setup dialog box where you can define the print settings.
	<b>Print.</b> Prints the map. For details, see <a href="#">"Print Dialog Box" on the previous page</a> .
	<b>Zoom In.</b> Zooms in to focus on specific details of the map.
	<b>Zoom Out.</b> Zooms out to view the map.
	<b>Fit.</b> Fit the complete view in the pane.

## Print Setup Dialog Box

This dialog box enables you to define the print settings for a topology map.



<b>To access</b>	Select <b>Operations &gt; Print Setup</b> .
<b>Relevant tasks</b>	<a href="#">"How to Print and Save a Topology Map to File" on page 213</a>
<b>See also</b>	<ul style="list-style-type: none"> <li>• <a href="#">"Topology Map Overview" on page 148</a></li> <li>• <a href="#">"Topology Map User Interface" on page 149</a></li> </ul>

User interface elements are described below:



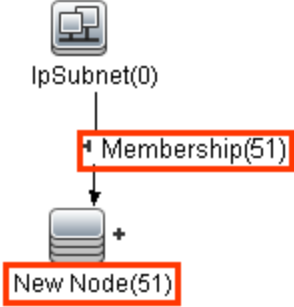

<b>UI Element (A-Z)</b>	<b>Description</b>
<b>Actual Size</b>	Print the view as it really is.
<b>Color</b>	Set the text color.
<b>Font</b>	Set the required font.
<b>Page Setup</b>	Set the printer settings.
<b>Pages</b>	Divide the map into rows and columns and print each section separately. Enter the number of columns and rows in the <b>Page Columns</b> and <b>Page Rows</b> boxes.
<b>Position</b>	Select the position of the caption from the <b>Position</b> list.
<b>Print Background</b>	Print the background behind the view.
<b>Print Border</b>	Print the map with a border. Click <b>Color</b> to select the required border color.
<b>Print Caption</b>	Enter the caption in the text area and click <b>Font</b> to select the required custom font.
<b>Print Crop Marks</b>	Print the crop marks.
<b>Print Current Selection</b>	Print the selected graph nodes and their relationships.
<b>Print Current Window</b>	Print the part of the view that appears in the pane.
<b>Print Entire Drawing</b>	Print the complete view.
<b>Print Page Numbers</b>	Print the page numbers.
<b>Zoom Level</b>	Print the view at the current zoom level.



## Toolbar Options

The following table contains a description of each Topology Map toolbar option, organized alphabetically.

Button	Option Name	Use This Option to...
	<p><b>Additions Count</b></p>	<p>Calculate the number of instances that are created as a result of an Enrichment Rule. The number of TQL query node instances and relationships that are created appear next to the Enrichment query nodes/relationships, as seen in the figure below.</p> <div style="text-align: center;">  <pre> graph TD     A[IpSubnet(0)] --&gt; B[Membership(51)]     B --&gt; C[New Node(51)]             </pre> </div> <p><b>Note:</b> This option appears on the toolbar in Enrichment Manager only.</p>
	<p><b>Advanced Pane</b></p>	<p>Toggle between hiding and displaying the Advanced Pane at the bottom center of the screen.</p> <p><b>To access:</b> Select <b>View &gt; Advanced Pane</b>.</p>
	<p><b>Calculate Query Result Count</b></p>	<p>Calculate the number of instances found for each TQL query node/relationship.</p>
	<p><b>Change Label Length/Properties</b></p>	<p>Enter the maximum number of characters that the labels should contain.</p> <p><b>To access:</b> In IT Universe Manager and the Modeling Studio, select <b>Layout &gt; Change Label Properties</b>. In the other managers, select <b>Layout &gt; Change Label Length</b>.</p>







Button	Option Name	Use This Option to...
	<b>CI Types Tree</b>	<p>Toggle between hiding and displaying the CI Type Selector at the right of the screen.</p> <p><b>To access:</b> Select <b>View &gt; CI Types Tree</b>.</p> <p><b>Note:</b> In the Modeling Studio, this option is called CI Types.</p>
	<b>Create Relationship</b>	<p>In most managers, create a relationship between two existing TQL query nodes. For details, see "<a href="#">How to Add Query Nodes and Relationships to a TQL Query</a>" on page 26.</p> <p>In IT Universe Manager, create a relationship between existing CIs. For details, see "<a href="#">Attaching Existing CIs</a>" on page 190.</p>
	<b>Delete Selected Item (s)</b>	Delete a CI from IT Universe Manager or a TQL query node from Impact Analysis Manager or Enrichment Manager.
	<b>Drag Map</b>	<p>Drag the view.</p> <p><b>To access:</b> Open the drop-down menu in the <b>Mode</b> box or select <b>View &gt; Drag Map</b>. In IT Universe Manager and the Modeling Studio, select <b>Layout &gt; Dragging Mode</b>.</p>
	<b>Drill Down One Layer</b>	<p>Move down one level in the topology map. This option is enabled only if there is an additional CI layer below it, created by setting the hierarchy of the view. For details on setting the hierarchy, see "<a href="#">Setting the View Hierarchy</a>" on page 257.</p> <p><b>Note:</b> This option appears only in IT Universe Manager.</p>
	<b>Enable/Disable Related CIs Retrieval</b>	<p>Toggle between disabling and enabling the redrawing of the topology map with related CIs when selecting a new CI in the CI Selector.</p> <p><b>Note:</b> This option appears only in IT Universe Manager in the Related CIs tab.</p>





Button	Option Name	Use This Option to...
	<b>Entities Tree</b>	<p>Toggle between hiding and displaying the manager specific entities tree at the left of the screen.</p> <p><b>To access:</b> Select <b>View &gt; Entities Tree</b>.</p> <p><b>Note:</b> In the Modeling Studio, each of the tabs of the Left pane (Resources, CI Types, CI Selector) is listed as a separate option.</p>
	<b>Export Map to Image</b>	<p>Save the topology map to a file. For details, see <a href="#">"Export Map to Image Dialog Box"</a> on page 150.</p> <p><b>To access:</b> Select <b>Operations &gt; Export Map to Image</b>.</p>
	<b>Fit to Window</b>	<p>Fit the complete map in the pane.</p> <p><b>To access:</b> Select <b>Layout &gt; Fit to Window</b>.</p>
	<b>Generate Direct Link</b>	<p>Generate a direct link to a view or CI.</p> <p><b>To access:</b> Select <b>Edit &gt; Generate Direct Link</b>.</p>
	<b>Go Up One Layer</b>	<p>Move up one level in the topology map. This option is enabled only if there is an additional CI layer above it, created by setting the hierarchy of the view. For details on setting the hierarchy, see <a href="#">"Setting the View Hierarchy"</a> on page 257.</p> <p><b>Note:</b> This option appears only in IT Universe Manager.</p>
	<b>Hide All Inheritance From Map</b>	<p>Toggle between showing and hiding Inheritance_f relationships and their connecting query nodes.</p> <p><b>To access:</b> Select <b>Layout &gt; Hide All Inheritance From Map</b>.</p> <p><b>Note:</b> This option is only active on the toolbar in CI Type Manager.</p>
	<b>Hide All Query Node Labels</b>	<p>Toggle between showing or hiding the CI/CIT/query node/pattern labels.</p> <p><b>To access:</b> Select <b>Layout &gt; Hide All Query Node</b></p>

Button	Option Name	Use This Option to...
		<p><b>Labels.</b></p> <p><b>Note:</b> This option is not available in IT Universe Manager and the Modeling Studio.</p>
	<p><b>Hide All Relationship Labels</b></p>	<p>Toggle between showing or hiding the relationship labels.</p> <p><b>To access:</b> Select <b>Layout &gt; Hide All Relationship Labels.</b></p> <p><b>Note:</b> This option is called <b>Hide edges' labels</b> in IT Universe Manager and the Modeling Studio.</p>
	<p><b>Hide All Relationships</b></p>	<p>Toggle between showing and hiding the relationships in the displayed map.</p> <p><b>To access:</b> Select <b>Layout &gt; Hide All Relationships.</b></p> <p><b>Note:</b> This option is not available in IT Universe Manager and the Modeling Studio.</p>
	<p><b>Hide/Show Get Related Cls pane</b></p>	<p>Toggle between hiding and displaying the Get Related Cls pane.</p> <p><b>Note:</b> This option appears only in IT Universe Manager in the Related Cls tab.</p>
	<p><b>Interactive Zoom</b></p>	<ul style="list-style-type: none"> <li>• Decrease the view magnification by clicking and pushing the pointer upwards.</li> <li>• Magnify the view by clicking and pulling the pointer downwards.</li> </ul> <p><b>To access:</b> Open the drop-down menu in the <b>Mode</b> box or select <b>View &gt; Interactive Zoom.</b></p> <p><b>Note:</b> This option is not available in IT Universe Manager and the Modeling Studio.</p>

Button	Option Name	Use This Option to...
	<b>Layout</b>	<p>Select the layout display from the list. The options are:</p> <ul style="list-style-type: none"> <li>• <b>Hierarchical Layout.</b> Enables you to display the precedence relations in the topology map.</li> <li>• <b>Hierarchical Layout with Orthogonal Routing.</b> Displays a hierarchical layout with edges composed exclusively of horizontal and vertical lines, forming right angles where they intersect.</li> <li>• <b>Symmetric Layout.</b> Enables you to display clear representations of complex networks.</li> <li>• <b>Circular Layout.</b> Groups a graph's nodes into groups or clusters.</li> <li>• <b>Orthogonal Layout.</b> Displays a layout with edges composed exclusively of horizontal and vertical lines, forming right angles where they intersect.</li> </ul> <p>For further details about each of the options, see <a href="#">"Layout Properties Dialog Box" on page 150</a>.</p> <div style="background-color: #f0f0f0; padding: 5px;"> <p><b>Note:</b> These layout options are only relevant for Enrichment Manager, CIT Manager, and Impact Analysis Manager.</p> </div>
	<b>Layout Properties</b>	<p>Define the view's layer layout, by assigning positions for the query nodes and relationships of the view. For details, see <a href="#">"Layout Properties Dialog Box" on page 150</a>.</p> <p><b>To access:</b> Select <b>Layout &gt; Layout Properties</b>.</p>
	<b>Log Configuration</b>	<p>Open the Log Configuration dialog box.</p> <p><b>To access:</b> Select <b>Tools &gt; Log Configuration</b>.</p>
	<b>Map overview</b>	<p>Open a small box with a copy of the topology map. This is useful in large views when zooming in.</p> <p><b>To access:</b> Select <b>Layout &gt; Map Overview</b>. In IT</p>

Button	Option Name	Use This Option to...
		Universe Manager and the Modeling Studio, select <b>Layout &gt; Show Map Overview</b> .
	<b>Maximize Workspace/Restore Workspace</b>	Toggle between the regular display and a full-screen display of the topology map.
	<b>Navigation</b>	<p>Take the pointer to the next connected CI/CIT/TQL query node in a clockwise direction.</p> <ul style="list-style-type: none"> <li>• Left-click to move in a clockwise direction.</li> <li>• Right-click to point to the next CI/CIT/query node/pattern in a clockwise direction.</li> </ul> <p><b>To access:</b> Open the drop-down menu in the <b>Mode</b> box or select <b>View &gt; Navigation</b>.</p> <div style="background-color: #f0f0f0; padding: 10px; margin-top: 10px;"> <p><b>Note:</b></p> <ul style="list-style-type: none"> <li>• You can use this option only on CI/CIT/query nodes/patterns that are connected by relationships.</li> <li>• This option is not available in IT Universe Manager and the Modeling Studio.</li> </ul> </div>
	<b>New CI</b>	<p>Define a new unrelated CI. For details, see <a href="#">"Working with CIs" on page 185</a>.</p> <div style="background-color: #f0f0f0; padding: 10px; margin-top: 10px;"> <p><b>Note:</b> This option appears on the toolbar in IT Universe Manager only.</p> </div>
	<b>New Related CI</b>	<p>Define a new related CI. For details, see <a href="#">"Working with CIs" on page 185</a>.</p> <div style="background-color: #f0f0f0; padding: 10px; margin-top: 10px;"> <p><b>Note:</b> This option appears on the toolbar in IT Universe Manager only.</p> </div>
	<b>Place in Center</b>	<p>Place the selected CI/CIT/query nodes/pattern in the center of the map.</p> <p><b>To access:</b> Select <b>Layout &gt; Place in Center</b>.</p>

Button	Option Name	Use This Option to...
		<p><b>Note:</b> This option is not available in IT Universe Manager and the Modeling Studio.</p>
	<b>Print</b>	<p>Print the contents of the topology map. For details, see <a href="#">"Print Dialog Box" on page 165</a>.</p> <p><b>To access:</b> Select <b>Operations &gt; Print...</b></p>
	<b>Print Preview</b>	<p>Preview the contents of the map before printing.</p> <p><b>To access:</b> Select <b>Operations &gt; Print Preview</b>.</p>
	<b>Print Setup</b>	<p>Define print settings for printing the topology map. For details, see <a href="#">"Print Setup Dialog Box" on page 166</a>.</p> <p><b>To access:</b> Select <b>Operations &gt; Print Setup...</b></p>
	<b>Remove Enrichment Results</b>	<p>Remove the instances created from an Enrichment rule from the CMDB.</p> <p><b>Note:</b> This option appears on the toolbar in Enrichment Manager only.</p>
	<b>Screen Capture</b>	<p>Take a snapshot of the screen using the Screen Capture tool.</p> <p><b>To access:</b> Select <b>Tools &gt; Screen Capture</b>.</p>
	<b>Select</b>	<p>Select a CI/CIT/TQL query node or multiple CIs/CITs/TQL query nodes.</p> <p><b>To access:</b> Open the drop-down menu in the <b>Mode</b> box or select <b>View &gt; Select</b>. In IT Universe Manager and the Modeling Studio, select <b>Layout &gt; Selection Mode</b>.</p>
	<b>Select All</b>	<p>Select all the CIs and relationships in a selected layer.</p> <p><b>To access:</b> Select <b>Edit &gt; Select All</b>.</p> <p><b>Note:</b> This option is not available in IT Universe Manager and the Modeling Studio.</p>











Button	Option Name	Use This Option to...
	<b>Select All Query Nodes</b>	<p>Select all the query nodes in a selected layer.</p> <p><b>To access:</b> Select <b>Edit &gt; Select All Query Nodes</b>.</p> <p><b>Note:</b> This option is not available in IT Universe Manager and the Modeling Studio.</p>
	<b>Select Columns</b>	<p>Enables you to select the columns to be displayed. For details, see "<a href="#">Select Columns Dialog Box</a>" on <a href="#">page 571</a>.</p> <p><b>Note:</b> This option is displayed in Text mode of IT Universe Manager only.</p>
	<b>Set Change Timeframe</b>	<p>Open the Change Timeframe dialog box, which enables you to set the period for the display of added or changed CI indicators.</p> <p><b>Note:</b> This option appears on the toolbar in IT Universe Manager only.</p>
	<b>Show Candidates for Deletion</b>	<p>Identify the CIs in the current view which are candidates for deletion.</p> <p><b>Note:</b> This option appears on the toolbar in IT Universe Manager only.</p>
	<b>Show Schedule Info</b>	<p>Display the scheduling information for the selected job. For details, see "Discovery Scheduler Dialog Box" in the <i>HP Universal CMDB Data Flow Management Guide</i>.</p> <p><b>Note:</b> This option appears on the toolbar in <b>Data Flow Management &gt; Discovery Module/Jobs &gt; Dependency Map tab</b>. For details, see "Dependency Map Tab" in the <i>HP Universal CMDB Data Flow Management Guide</i>.</p>
	<b>Sort Column Content</b>	<p>Enables you to set the order of the visible columns. For details, see "<a href="#">Sort Column Content Dialog Box</a>"</p>











Button	Option Name	Use This Option to...
		<p>on page 572.</p> <p><b>Note:</b> This option is displayed in Text mode of IT Universe Manager only.</p>
	<b>Straighten</b>	<p>Straightens any selected relationship between two query nodes that has angles.</p> <p><b>To access:</b> Select <b>Layout &gt; Straighten</b>.</p> <p><b>Note:</b> This option is only available in Enrichment Manager and Impact Analysis Manager.</p>
	<b>User Preferences</b>	<p>Opens the User Preferences dialog box which enables you to reset warning message preferences. For details, see "<a href="#">User Preferences Dialog Box</a>" on page 93.</p> <p><b>To access:</b> Select <b>Tools &gt; User Preferences</b>.</p>
	<b>User Profile</b>	<p>Opens the User Profile dialog box which displays the user details for the user currently logged in.</p> <p><b>To access:</b> Select <b>Tools &gt; User Profile</b></p>
	<b>Zoom In</b>	<p>Zoom in on a specific section of the topology map by clicking and drawing a selection rectangle around the part to magnify. The area you select is displayed at the highest percentage that fits in the topology map.</p> <p><b>To access:</b> Open the drop-down menu in the <b>Mode</b> box or select <b>View &gt; Zoom In</b>. In IT Universe Manager and the Modeling Studio, select <b>Layout &gt; Zoom in</b>.</p>

## Topology Map Sidebar

The following table contains a description of each Topology Map sidebar option. The Topology Map sidebar appears in IT Universe Manager and the Modeling Studio.



Button	Option Name	Use This Option to...
	<b>Move Layout Toolbar to Right/Left</b>	Move the sidebar to the right or left side of the screen.
	<b>Zoom In/Out</b>	Zoom in or out on the topology map.
	<b>Selection Mode/Dragging Mode</b>	Toggle between Selection mode and Dragging mode in the topology map.
	<b>Refresh to get an optimal layout</b>	Refresh the topology map to optimize the layout.
	<b>Fit to Window</b>	Fit the complete map in the pane.
	<b>Change Map Layout</b>	Select the map layout. The following options are available: <ul style="list-style-type: none"> <li data-bbox="732 1121 1317 1192">                         •  <b>Hierarchical Layout.</b> Displays the precedence relations in the topology map.                     </li> <li data-bbox="732 1247 1338 1390">                         •  <b>Hierarchical Layout with Orthogonal Routing.</b> Displays a hierarchical layout with edges composed exclusively of horizontal and vertical lines, forming right angles where they intersect.                     </li> <li data-bbox="732 1444 1312 1516">                         •  <b>Circular Layout.</b> Groups a graph's nodes into groups or clusters.                     </li> <li data-bbox="732 1570 1354 1684">                         •  <b>Orthogonal Layout.</b> Displays a layout with edges composed exclusively of horizontal and vertical lines, forming right angles where they intersect.                     </li> <li data-bbox="732 1738 1365 1810">                         •  <b>Symmetric Layout.</b> Displays clear representations of complex networks.                     </li> </ul>

Button	Option Name	Use This Option to...
	<p><b>Map Settings</b></p>	<p>You can modify the following settings:</p> <ul style="list-style-type: none"> <li>  <b>Hide/Show Edges' Labels.</b> Hide or display the labels of all relationships.         </li> <li>  <b>Hide/Show Count Indicators.</b> Hide or display the count indicators for the query nodes.         </li> <li>  <b>Enable/Disable Edges' Highlighting.</b> Highlight all the relationships to and from the selected query node.         </li> <li>  <b>Hide/Show Legend.</b> Toggle between hiding and displaying the topology map legend.         </li> </ul>
	<p><b>Map Tools</b></p>	<p>The following tools are available:</p> <ul style="list-style-type: none"> <li>  <b>Show Map Overview.</b> Open a small box with a copy of the topology map. This is useful in large views when zooming in.         </li> <li>  <b>Print.</b> Print the topology map.         </li> <li>  <b>Export Map to Image.</b> Save the topology map to a file.         </li> </ul>
	<p><b>Expand All Groups</b></p>	<p>Expand all the CI groupings in the topology map.</p> <p><b>Note:</b> This option is only available when a grouping option is selected.</p>
	<p><b>Collapse All Groups</b></p>	<p>Collapse all the CI groupings in the topology map.</p> <p><b>Note:</b> This option is only available when a grouping option is selected.</p>

# Automated Service Modeling

Automated Service Modeling provides the ability to automatically map the complexity of critical business services and business applications, starting from an entry point for the service (usually the URL of the service). You can use the UCMDB Browser to easily create a model of a particular service (starting from the service's URL) or enterprise application (using existing out-of-the-box discovery content). You can select an entry point to perform a top-down discovery, or model multiple applications that have already been discovered. The process is simplified and put in the control of the service owner.

Automated Service Modeling automatically discovers and models service maps, and provides the following capabilities:

- A service model that is maintenance-free, and appears in near real time.
- The ability to accurately discover the service in a top-down manner, and to see the map update automatically.
- The ability to take advantage of existing integrations and infrastructure.
- The ability to prioritize discovery problems in the context of a service.
- The ability to contact a UCMDB administrator in case of advanced discovery errors.
- Constant tracking of dynamic changes in a business service's infrastructure.
- The ability to quickly identify the impact of changes to CIs in complex environments.
- The ability to define service border rules.

Once you have created a service map, you can interact with it by showing or hiding layers of associated data (servers, historical changes, virtualization, networking, or storage topologies).

You can find more details about the Automated Service Modeling feature in the following sections:

- **Business Service Discovery** in the *HP Universal CMDB Data Flow Management Guide*: This section introduces the service discovery user interface and how to run service discovery.
- **Mapping Consumer-Provider Dependencies** in the *HP Universal CMDB Developer Reference Guide*: This section contains all the behind-the-scene information for developers' reference.
- **Service Modeling** in the *HP Universal CMDB Browser User Guide*: This section describes how to work with Automated Service Modeling from the UCMDB Browser.

# Modeling

# Chapter 7: IT Universe Manager

This chapter includes:

IT Universe Manager Overview .....	181
Working with Views in IT Universe Manager .....	182
View Tree Structure .....	184
Working with CIs .....	185
Working with Relationships .....	188
How to Create CIs and Relationships .....	194
How to View Related CIs .....	194
How to Check the Status of Application Discovery (Rediscover a View) .....	196
How to Check the Network Availability of an Inventory CI .....	198
How to View Discovery Status and Errors for a Selected CI .....	201
How to Retrieve Impact Analysis Results – Scenario .....	207
How to Take a Snapshot of a View .....	213
How to Print and Save a Topology Map to File .....	213
IT Universe Manager User Interface .....	213

## IT Universe Manager Overview

IT Universe Manager enables you to manage the content of your IT Universe model. The following tasks represent the basic functionality of the application:

- **Creating CIs without creating relationships.** You can define new CIs that are added to the CMDB individually, so that no new relationships are created. For details, see "[Creating a Non-Related CI](#)" on [page 185](#).
- **Creating CIs with relationships for them.** You can define new CIs and attach them to existing CIs, so defining a new CI and a new relationship in the CMDB. For details, see "[Creating a Related CI](#)" on [page 186](#).

- **Adding existing CIs and creating relationships for them.** You can attach CIs to an existing CI, so creating new relationships for existing CIs. For details, see ["Attaching Existing CIs" on page 190](#).
- **Deleting CIs.** You can delete CIs from the CMDB. For details, see ["Deleting CIs" on page 186](#).
- **Getting Impact Analysis results.** You can run the Impact rules you defined for a view to simulate how certain defined changes impact your system, and to discover the root causes of the changes. For more information about Impact rules, see ["Impact Analysis Manager Overview" on page 466](#).
- **Taking a snapshot of a view.** HP Universal CMDB enables you to display the status of a view in one snapshot by comparison with its status taken at a different time. For details on how to take snapshots, see ["How to Take a Snapshot of a View" on page 213](#).

## Populating the IT Universe Model

The IT Universe model in the CMDB contains the CIs and relationships produced by the CI-generating tools that operate within HP Universal CMDB. Most CIs and relationships originate from one of the following sources:

- **Data Flow Management (DFM).** Automatically creates CIs and relationships based on the discovered IT resources and topology in your company's infrastructure. For details, see *Data Flow Management Overview* in the *HP Universal CMDB Data Flow Management Guide*.
- **IT Universe Manager.** Enables you to manually create CIs and relationships that represent logical and physical elements of the business. For details, see ["Working with CIs" on page 185](#).
- **Enrichment Manager.** Enables you to add CIs and relationships to the CMDB by receiving data from the attributes of Enrichment query nodes as defined in the Enrichment TQL query. For details, see ["Enrichment Manager" on page 529](#).

## Working with Views in IT Universe Manager

In IT Universe Manager, you analyze data at the view level. Views are subsets of the IT Universe, containing only those CIs relating to a specific area of interest. All views are based on a pattern which determines the content of the view.

- Pattern views and template-based views are built from a TQL (Topology Query Language) query that defines the structure of the view. The view displays only those CIs and relationships that satisfy the query definition.

- Perspective-based views are built manually, by selecting a group of CIs and applying perspectives to them. A perspective is a pattern used to define which related CIs are included in the view.

You build all views in the Modeling Studio, using the appropriate editor for each view type. For information on the different view types and how they function, see "[View Formats](#)" on page 255.

**Note:** You must have **Update** permissions for a view to edit the view. If you do not have the necessary permissions, contact your HP Universal CMDB Administrator.

CIs created by DFM are automatically added to each view where the CIs (and their relationships) fit the TQL definition for the view. When you open a view in the CI Selector, the TQL query for the view queries the CMDB for CIs that match the defined pattern. If there are no matches (for example, in the case of a view for a DFM process where the process has not yet run) then the view remains empty.

You can also include CIs from external data sources (federated CIs) in your view, by defining the query to run over integration points for federated data sources. The federated CIs appear in the view with an arrow icon indicating that they are from a federated source.



For details on federated data sources, see "Integration Studio Overview " in the *HP Universal CMDB Data Flow Management Guide*.

**Note:** For out-of-the-box queries that have integration points defined, the data source is set as UCMDB.

When you define a new CI while working in any view in IT Universe Manager, the CI (and any associated relationship) is created in the CMDB. The CI is added to your current view only if it meets the view's TQL specifications.

If the created CI and relationship do not meet the TQL requirements, then the CI and relationship are created in the CMDB but are not visible in the view. Similarly, if you attach an existing CI to a CI in the view, and the new pattern does not meet the TQL requirements, then the attached CIs do not appear in the view, but the relationship is still created.

## Templates and Template-based Views

If you open a template in IT Universe Manager, it is displayed in the topology map like a pattern view. Click the **Show Template Parameters**  button on the CI Selector toolbar to open the Template Parameter Values dialog box, where you can change the values of the template parameters and thereby

affect the view results displayed in the topology map. You can try different parameter values and see the resulting topology map, but you cannot save changes to the template itself. To save the view results as a template-based view with the selected parameters, click the **Save As View** button in the Template Parameter Values dialog box.

You can also create a direct link to a template in IT Universe Manager and insert the parameter values directly into the URL. For details, see "[How to Create a Direct Link to a Template with Parameter Values](#)" on page 105.

## View Lifecycle

If you do not access a view from the CI Selector for a specified period of time, the view is cleared out, to save memory in the system. It is not deleted from the CMDB; the view can be retrieved by clicking on it. The default time period for clearing out unused views is one hour.

**Note:** Views defined as persistent are not cleared out and always remain in the memory.

## Hidden Views

You can designate a view as a hidden view that does not appear in IT Universe Manager by defining a bundle for hidden views and assigning the view to that bundle.

### To designate a view as a hidden view:

1. In the Infrastructure Settings Manager, select **Hidden Bundles Names in CI Selector**.
2. Enter the name of the new bundle as the default value and save the setting.
3. In the Modeling Studio, open the relevant view and click the **View Definition Properties**  button on the toolbar.
4. In the View Definition Properties dialog box, select the hidden views bundle and assign the view to it.

## View Tree Structure

Views are organized in a hierarchical tree format in the left pane of IT Universe Manager, which is known as the CI Selector. The view name appears in the View box above the tree and acts as the containing folder for the CIs in the view.



The first level of the CI Selector tree consists of the query nodes for the root CIs. A root CI is the starting point for a view subtree. A view may contain any number of subtrees. Under the root CIs come the branch CIs, expanding down to the leaf CIs as the last query nodes at the ends of each branch.

The CIs at each level in a subtree are considered to be attached to the CI on the branch directly above. This attachment generally depicts a dependent relationship, so that the higher branch (closer to the root CI) represents a component of your business that depends on the CIs on the next branch down (closer to the leaf CIs) in the business process. For example, an application depends on the servers running the application.

The attachment between a higher and a lower query node is referred to as a parent-child relationship. The parent CI may have many attached child CIs, and the child CIs pass operational status to the parent.

The tree topology is determined by the hierarchy defined for the view. In a pattern view, these are defined for the specific view. In a template-based or a perspective-based view, the hierarchy is defined as part of the template or perspective. For details on defining the hierarchy, see ["Setting the View Hierarchy" on page 257](#).

## Working with CIs

In IT Universe Manager, you can create related and non-related CIs, delete CIs, edit the CI properties, and remove out-of-date CIs using the aging mechanism.

This section includes the following topics:

- ["Creating a Non-Related CI" below](#)
- ["Creating a Related CI" on the next page](#)
- ["Deleting CIs" on the next page](#)
- ["CI Properties" on page 187](#)
- ["Removing Out-of-Date CIs Using the Aging Mechanism" on page 187](#)

### Creating a Non-Related CI

You can define a new CI in IT Universe Manager by clicking the **New CI**  button on the toolbar. The New CI dialog box opens, which enables you to define the properties for the new CI. The CI is created in the CMDB. For details, see ["New CI/New Related CI Dialog Box" on page 242](#).

**Note:** The CI is added to the view only if it meets the specifications of the pattern of the view, template, or perspective.

A CI created in this way is added as an independent entity without any relationship to any other existing CI in the CMDB.

## Creating a Related CI

You can define a new CI to be added as a parent, child, or sibling of an existing CI.

### To define a new related CI:

1. Select the CI in your view to which you want to attach the new CI.
2. Click the **New Related CI**  button on the toolbar.
3. In the New Related CI dialog box, define the properties and relationship for the CI. For details, see ["New CI/New Related CI Dialog Box" on page 242.](#)

The CI and relationship are created in the CMDB.

**Note:** The CI and relationship are added to the view only if they meet the specifications of the pattern of the view, template, or perspective.

## Deleting CIs

You can delete a CI by selecting **Delete from CMDB** from the shortcut menu in IT Universe Manager. The CI is deleted from the CMDB and from all views. If the CI has children, they are not automatically deleted when you delete the parent CI. If you delete a CI without first deleting the relationship between the CI and any child CIs that appear with the parent CI in a view, the child CIs are removed from the view.

If the child CIs do not appear in any other view, they remain in the CMDB without appearing in a view. The child CIs might appear in the future in views where they meet the pattern requirements.

One exception to this rule is when the relationship between a child and parent CI is a **Composition** relationship; in that case, when the parent CI is deleted, the contained CI is also removed from the CMDB. For example, if a node CI is the container for a child CPU CI, then when the node CI is deleted, the CPU is also removed from the CMDB.

When you delete a CI that was created by the DFM process, the CI is restored the next time that DFM runs (if the CI is still valid), and it reappears in all relevant views.

**Note:** Sometimes, a CI is deleted from the CMDB but it still appears in a TQL query because the query was not yet updated due to its priority level. When the query is consumed in IT Universe Manager, UCMDB cannot find any of the CI's properties, and it is displayed with a **no label** name in the topology map.

## CI Properties

In IT Universe Manager, you can edit the properties of a CI. The CI properties are divided into several categories which appear in the New CI dialog box:

- The general properties of a CI are common to all CIs. Some general properties are defined automatically during CI creation; others can only be defined manually in the New CI dialog box.
- CIT-specific properties are created as part of the CIT definition in the CI Type Manager. The values for the CIT-specific properties are taken from the CIs discovered during DFM. The values can also be entered manually, when you manually create CIs to represent entities in your infrastructure. For details, see ["CI Type Manager" on page 485](#).
- Key properties can be general or CIT-specific properties, which must be assigned a value to create an instance of the CI type.

You can access the Configuration Item Properties dialog box to view the CI properties from IT Universe Manager by right-clicking the CI and selecting **Properties** or by clicking the Properties tab in the Advanced pane. You can also edit the CI properties if you have the necessary permissions for editing CIs. For details on CI properties, see ["Configuration Item Properties Dialog Box" on page 220](#).

The CIT-specific properties are displayed in the **Specific Properties** section of the Configuration Item Properties dialog box when you sort the properties using the **Categorized** button. Some properties for the automatically created CIs can be edited, however, if the CI is configured to **Allow CI Update** (in the General Properties), then DFM may override your changes when it updates the CI. A description of the selected property can be found in the Description area at the bottom of the Configuration Item Properties dialog box.

Some of the CIT-specific properties for DFM CIs are set by default to be monitored for changes. When one of these properties has been modified, information on the change can be viewed in a CI change report. For more information, see ["CI Change Report" on page 380](#).

## Removing Out-of-Date CIs Using the Aging Mechanism

If a CI or relationship is not updated or refreshed over a period of time (for example, a CI is not rediscovered by DFM and no manual update occurs), an aging mechanism deletes the CI from the CMDB.

For details, see CI Lifecycle and the Aging Mechanism in the *HP Universal CMDB Administration Guide*.

**Note:** The following actions that apply to CIs cannot be performed on federated CIs:

- Editing the CI properties
- Deleting the CI
- Creating a relationship to another CI
- Viewing the CI History
- Adding the CI to a Discovery job
- Removing the CI from a Discovery job

## Working with Relationships

Many of the relationships between CIs in the CMDB are created automatically, for example, by DFM. In addition, you can create relationships manually in IT Universe Manager, Enrichment Manager, Impact Analysis Manager, or the Modeling Studio.

This section includes the following topics:

- ["Creating Relationships" on the next page](#)
- ["Creating Hierarchical Relationships" on the next page](#)
- ["Attaching Existing CIs" on page 190](#)
- ["Setting the View Hierarchy" on page 190](#)
- ["Relationship Properties" on page 191](#)
- ["Viewing Related CIs" on page 191](#)
- ["Deleting Relationships" on page 191](#)
- ["Inter-Layer Relationships" on page 192](#)

## Creating Relationships

You can create relationships by right-clicking a CI or multiple CIs in the CI Selector pane or the Topology Map and selecting **Relate to CI** from the shortcut menu. In the Topology Map, you can define a relationship between two CIs in the view by drawing a line between the two, using the **Create Relationship**  button from the toolbar. Either of these actions opens the Insert Relationship dialog box. For details, see ["Insert Relationship Dialog Box" on page 226](#).

You can create as many relationships as necessary between a CI in the CMDB and other CIs. Each new relationship exists as its own entity in the CMDB, and has its own properties that can be edited in IT Universe Manager (as described in ["Configuration Item Properties Dialog Box" on page 220](#)). You can also create more than one relationship between the same two CIs, when each relationship is based on a different relationship type. In the following example, `host7` has both a **Backbone** and a **Talk** relationship with `switch3`.

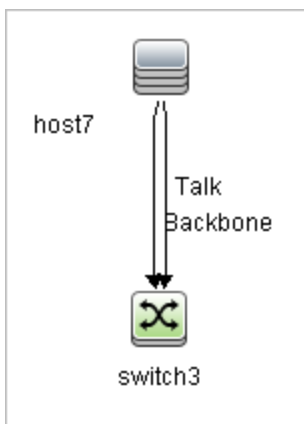

**Note:** If a Running Software CI is related to another CI with a Containment relationship, you cannot create another Containment relationship from the Running Software CI.

## Creating Hierarchical Relationships

By attaching one CI to another in IT Universe Manager you create a hierarchical relationship (parent-child) between them, so that one CI is influenced by the other.

Certain relationships defined in this way are restricted to the relationship type **usage** (if the relationship is between two non-monitoring CIs), or the relationship type **Monitored By** (if the child CI in the relationship is a monitor type CI); however, other relationship types are used between specific types of CIs. For example, if a relationship is defined between two node CIs, there are several possible relationship types.

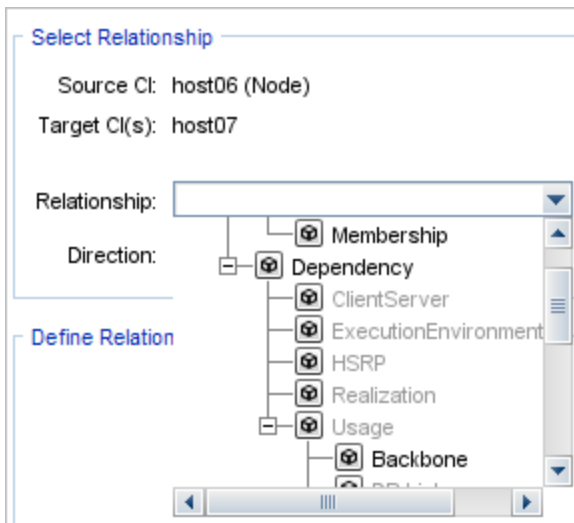

**Note:** When you attach a child CI to a parent CI, you are creating that relationship in the CMDB. The child therefore impacts on the parent CI in every view where the relationship exists, and is displayed in every view where the child and relationship match the TQL query.

### Attaching Existing CIs

You can attach existing CIs using the Insert Relationship dialog box. The dialog box has two modes:

- Selecting the CIs that you want to attach.
- Defining the relationship between the original CI and the CIs to attach.

When selecting the CIs to attach, you can select multiple CIs from a view to attach to the original CI. However, all CIs that you want to attach in one operation must have the same relationship type. For example, you cannot attach a CI that uses the relationship **usage** in the same operation as a CI that uses the relationship **Monitored By**.

### Setting the View Hierarchy

After setting the query node and relationship definitions of a view, you can set a hierarchy for the view. This enables you to define the organizational structure of CIs in the view by displaying selected CIs at different levels. When no hierarchy is defined, the Topology Map or table displays all CIs included in the query results on one level by default. For example, if the query results include nodes and IP Subnets, both CI types are displayed on the same level in the Topology Map or table.

**Note:** The maximum number of CIs that can be displayed in a single layer of the Topology Map is

900. If a view contains a layer with more than 900 CIs, the view is not displayed in the Topology Map until the hierarchy is changed. However, a layer with more than 900 CIs can be displayed in a table in Text mode.

For details on setting the hierarchy, see ["Setting the View Hierarchy" on page 257](#).

## Relationship Properties

Relationships have properties, similar to CIs. You can access the Configuration Item Properties dialog box to view the relationship properties from IT Universe Manager by right-clicking the relationship and selecting **Properties** or by clicking the Properties tab in the Advanced pane. You can also edit the relationship properties if you have the necessary permissions for editing CIs. For details on relationship properties, see ["Configuration Item Properties Dialog Box" on page 220](#).

**Note:** For relationships of type **composition** connected to a CI of type Node Element or its descendant CI types, relationship properties are not saved. When a TQL query containing such a relationship is run, the default values for the relationship properties are used even if you edited the properties.

## Viewing Related CIs

You can view all the CIs related to a selected CI in the topology map. Select a CI in a view and then select the **Related CIs** tab. The Get Related CIs pane enables you to select the scope of the display. If you select **View**, the topology map displays only the selected CI and its related CIs in the view (no matter where it is in the view hierarchy). If you select **CMDB**, it displays the selected CI and all of its related CIs in the CMDB. You can also filter the results from the Get Related CIs pane by CI type and apply perspectives to a CI. For details, see ["Get Related CIs Pane" on page 240](#).

You can also display Related CIs using the Get Related CIs from CMDB dialog box. For details, see ["Get Related CIs From CMDB Dialog Box" on page 226](#).

## Deleting Relationships

The Topology Map shows only the relationships for the CIs that are part of the current view; however, the same relationships may also be part of other views. When you delete a relationship in IT Universe Manager, it is deleted from the CMDB and from all views.

When a relationship is deleted, the CI on the other end of the relationship may remain in the view, if it still matches the pattern of the view. However, if the deleted relationship is a composition link, the target CI is deleted with it.

In a perspective-based view, you can remove the CI completely from the view (without deleting it from the CMDB), by hiding it from the view in the Perspective-based View Editor in the Modeling Studio.

When you delete a relationship that was created by the DFM process, the relationship is restored the next time that DFM runs (if the relationship is still valid), and it reappears in all relevant pattern views.

It can take a few minutes to delete subtrees, or multiple CIs and relationships, from a view.

### Inter-Layer Relationships

In certain circumstances, IT Universe Manager displays a relationship between CIs in a layer of a view that does not reflect an actual relationship between the CIs in that layer, but rather a relationship between CIs on deeper layers of the view. Such a relationship is known as an **inter-layer relationship**.

For example, in the following view, two node CIs are related to each other with a dependency relationship. Each is also related to an IP Subnet by a membership relationship and the view hierarchy is defined such that the nodes are on the layer beneath the IP Subnet.

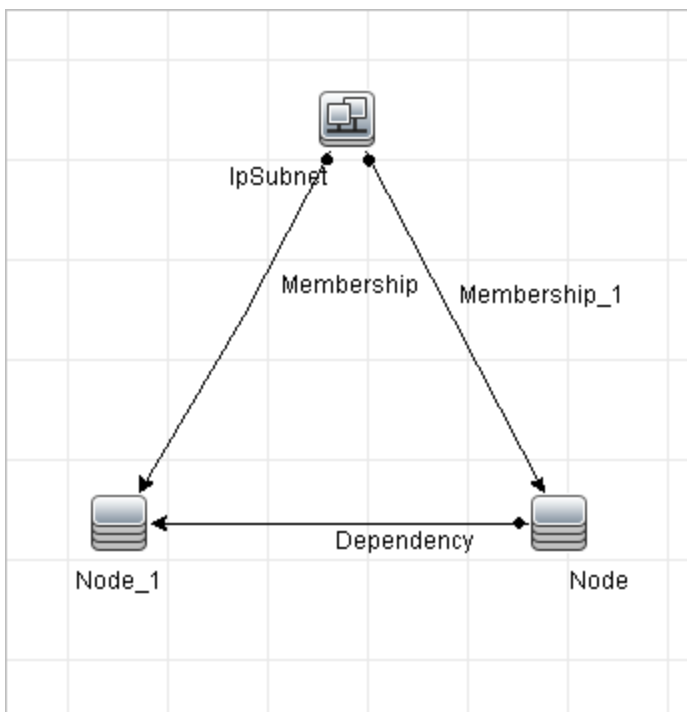

When you consume the view in IT Universe Manager, the relationship between the node CIs (which are under different IP Subnets) is displayed in the higher layer of the view as a relationship between the parent IP Subnets, even though the actual relationship only exists between the CIs in the lower layer of the view. You can double-click the relationship to display the full path between the IP Subnets.



Another form of inter-layer relationship occurs when the same CI appears under more than one parent CI of the same type in the layer above it. In such a case, the child CI and its relationships are duplicated in the view display, due to the hierarchy definition. The relationships of such child CIs result in inter-layer relationships between the parent CIs. This type of inter-layer relationship is known as a **duplication metalink**.

For example, in the following view, a single node CI appears under two IP Subnet CIs in the hierarchy. The node and its children thus appear twice in the view - once under each IP Subnet. Each node is effectively related to the child CIs of the node under the other IP Subnet, which generates an inter-layer relationship between the two IP Subnets.

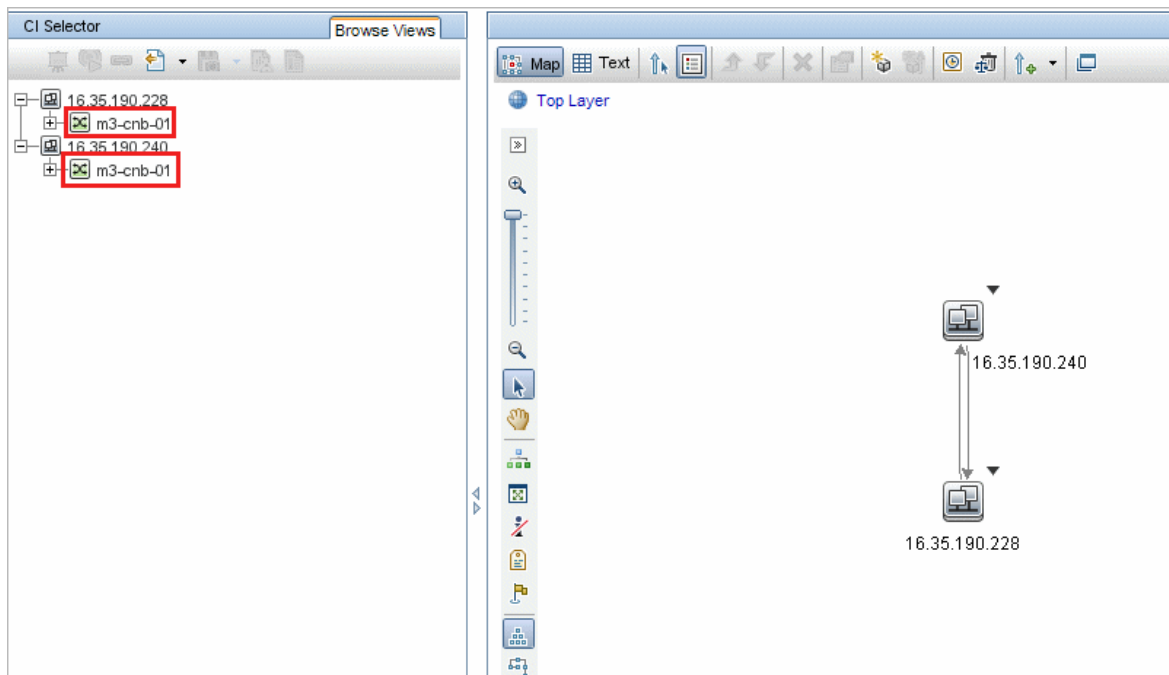

Inter-layer relationships and duplication metalinks are displayed in gray in the topology map. The following options are available for viewing inter-layer relationships (defined in the View Definition Properties dialog box in Modeling Studio):

- **None.** Hide all inter-layer relationships.
- **Inter-Layer.** Display inter-layer relationships of the first type, but not duplication metalinks.
- **Full.** Display all inter-layer relationships, including duplication metalinks.

A tooltip for the inter-layer relationship displays the inner relationships which it represents. If there is only one inner relationship, the relationship label displays that relationship type. If there are multiple inner relationships, the label becomes **Inter-layer** and the tooltip displays a list of all the inner

relationships. If there are more than ten inner relationships, only the first ten are displayed, and a note indicates that there are more inner relationships.

## How to Create CIs and Relationships

This task describes how to create related and non-related CIs, as well as relationships between CIs, in the CMDB.

This task includes the following steps:

- ["Define a New Non-related CI" below](#)
- ["Define a New Related CI" below](#)
- ["Attach Existing CIs" below](#)

### Define a New Non-related CI

Click the **New CI**  button on the toolbar. In the New CI dialog box, select a CI type from the tree and define the properties for the new CI. For details, see ["New CI/New Related CI Dialog Box" on page 242](#).

### Define a New Related CI

Click the **New Related CI**  button on the toolbar. In the **New Related CI** dialog box, select a CI type from the tree and define the properties for the new CI. On the Relationship page of the dialog box, select the type of relationship and define its properties. For details, see ["New CI/New Related CI Dialog Box" on page 242](#).

### Attach Existing CIs

Select a CI in a view. Right-click the CI and select **Relate to CI**. In the Insert Relationship dialog box, select a target CI. On the Relationship page of the dialog box, select the type of relationship and define its properties. For details, see ["Insert Relationship Dialog Box" on page 226](#).

## How to View Related CIs

The following steps describe the options for viewing related CIs in IT Universe Manager.

- ["Display Related CIs" below](#)
- ["Select the Scope of the Display" below](#)
- ["Filter the Related CIs" below](#)
- ["Apply Perspectives to a CI" below](#)

## Display Related CIs

In IT Universe Manager, select a CI in the Topology map or the CI Selector and select the **Related CIs** tab. Click the **Enable Related CIs Retrieval**  button. The selected CI is displayed with its related CIs. Select a different CI or multiple CIs from the CI Selector, and the display changes accordingly.

**Note:** You can display the Related CIs content in map mode or in text mode.

For details on the Get Related CIs user interface, see ["Get Related CIs Pane" on page 240](#).

## Select the Scope of the Display

In the Get Related CIs pane, select the scope of the related CIs display. Click the **Show Related CIs** button. The display changes according to your selection.

## Filter the Related CIs

In the Filter Related CIs by CI Type section, select the CI types to appear in the related CIs display. Click the **Filter Related CIs** button. The filtered results appear in the tab. The scope selected above still applies and the display is reduced according to your filter selection.

## Apply Perspectives to a CI

In the Apply Perspectives to CI section, select the perspectives to apply to your selected CI. Click the **Apply Perspectives** button. The results are displayed in the tab.

**Note:** This feature is only relevant when **CMDB** is selected as the scope.

## How to Check the Status of Application Discovery (Rediscover a View)

As an application owner or administrator, you need to be kept informed of any problems with your application. So, for example, it is important to know that discovery is working properly and that its current configuration can connect to the application database. This section explains how to run the rediscovery procedure that enables you to check the current status of the discovery of an application.

**Note:**

- Set up and configuration is performed by the UCMDB administrator. For details, see ["Prerequisites" below](#).
- Rediscovery is performed by the application owner/administrator. For details, see ["Access the View" on the next page](#).
- You do not need any knowledge of Data Flow Management (DFM) to run this procedure.
- By default, you can run the rediscovery procedure on views that contain fewer than 10,000 CIs. For details on changing this number, see ["Important information" on page 250](#).

This task includes the following steps:

- ["Prerequisites" below](#)
- ["Access the View" on the next page](#)
- ["View Results in the View" on the next page](#)
- ["Schedule the Rediscovery" on page 198](#)

### 1. Prerequisites

**Note:** This step is performed by the UCMDB administrator.

- a. In DFM, create a module that contains the jobs that must discover the application. For details, see *How to Run Module/Job-Based Discovery in the HP Universal CMDB Data Flow Management Guide*.

- b. Activate the module and all the jobs. The jobs must remain activated.
- c. Verify that the module has run without errors. For details, see [Error Messages Overview](#) and [Discovery Module/Jobs - Details Tab](#) in the *HP Universal CMDB Data Flow Management Guide*.
- d. Correct any errors in the application and confirm that DFM finds no errors during the next run.

**Caution:** The application owner cannot rediscover a view if DFM is reporting errors. You must set an error-free baseline.

- e. In the Modeling Studio, define a view that includes the application CI or CIs to be rediscovered. These are the CIs that are created when you activate the jobs that discover the application. For details, see ["How to Create a Pattern View" on page 271](#).
- f. Notify the application owner of the name of the view.

## 2. Access the View

**Note:** This step is performed by the application owner/administrator.

In IT Universe Manager, access the view that includes the application CIs to be rediscovered. For details, see ["How to Search for CIs in Search Mode" on page 131](#).

## 3. View Results in the View

- a. **Check the complete application.** Click the **Show Discovery and Changes Summary**  button on the CI Selector toolbar. The **Show Discovery Status and Changes of View** dialog box is displayed. The dialog box displays information about which jobs and trigger CI discovered the CIs in the view, on the last occasion that DFM ran the discovery for the jobs. For details, see ["Show Discovery Status and Changes Dialog Box" on page 250](#).

To run the discovery, click the **Rerun Discovery** button. To view information about the jobs and trigger CIs, use the links to drill down. For details, see [Error Messages Overview](#) in the *HP Universal CMDB Developer Reference Guide*.

- b. **Check specific components of your application.** Select the component's CI in the Topology Map pane and display the Discovery tab in the Advanced pane. For details, see ["Show Discovery Status and Changes Dialog Box" on page 250](#).

To rediscover several CIs, press **CTRL**, select the CIs and display the Discovery tab.

To run the discovery, click the **Rerun Discovery** button.

#### 4. Schedule the Rediscovery

You can schedule how often the rediscovery procedure should run. In the Job Definition window, choose the **Rerun Discovery on View** action. For details, see Job Definition Dialog Box in the *HP Universal CMDB Administration Guide*.

## How to Check the Network Availability of an Inventory CI

As a discovery administrator, you might often need to perform troubleshooting of network connection issues and/or credential related issues. This section explains how to use the network ping options available in the new **Check Network Availability** dialog box to troubleshoot network connection issues and/or credential related issues against an inventory CI in IT Universe Manager.

### Note:

- This feature is available for **Node** type inventory CIs only.
- To use this feature, you need to have the **Run Discovery and Integration** and the **Check Network Availability** permissions. The out-of-the-box **Discovery and Integrations Admin** role has all these permissions by default.

This task includes the following steps:

- [Prerequisites](#)
- [Check the Network Availability of an Inventory CI](#)

#### 1. Prerequisites

To use this feature, you need to have the **Run Discovery and Integration** and the **Check Network Availability** permissions. The out-of-the-box **Discovery and Integrations Admin** role has these permissions by default.

If you want to assign these permissions to a custom role (say, IT Administrator), do the following:

**Note:** This step is performed by the system administrator.

- a. Log in to UCMDB and go to **Security > Roles Manager > Roles**.
- b. Select a role for which you want to assign the required permissions.

You may need to create one if you do not have such a role. In this case, **IT Administrator** is created and selected.



- c. In the Resources tab of the IT Administrator window, select **CIT Menu Items** in the Resource Types pane, select **Node** in the Resources pane, and then select **Check Network Availability** in the Available Actions pane and move it the Selected Actions pane.
- d. Go to the **General Actions** tab of the IT Administrator window, select **Run Discovery and Integration** in the Available Actions pane and move it the Selected Actions pane.

## 2. Check the Network Availability of an Inventory CI



To check the network availability of an inventory CI of the **Node** type,

- a. In UCMDB, go to **Modeling > IT Universe Manager**.
- b. In IT Universe Manager, search for **Node** type inventory CIs.
- c. Select a CI of your interest from the returned result, and then right-click the inventory CI in the map and select **Actions > Check Network Availability** from the shortcut menu.
- d. Click a desired icon and provide necessary values in order to perform a network ping.

-  **IP Ping.** Displays the IP Ping Settings dialog box, which enables you to specify the necessary values to perform a network IP ping.
  - **IP Address.** Select the IP address of your target node (in IPv4 or IPv6 format) from the drop-down list of available IP addresses. You can also manually enter the IP address (in IPv4 or IPv6 format) of a target node.
  - **Probe.** Select a probe from the drop-down list of connected probes to perform IP ping.
  - **Ping Times.** Number of attempts for the selected probe to perform IP ping. Default value: 4.

- **Timeout (ms).** Frequency (in milliseconds) that the selected probe shall try to perform IP ping. Default value: 60,000 (ms).
-  **Ping with UD Agent.** Displays the UD Agent Ping Settings dialog box, which enables you to specify the necessary values to perform a network ping with UD agent.
  - **IP Address.** Select an IP address from the drop-down list of available IP addresses. You can also manually enter the IP address (in IPv4 or IPv6 format) of a target node.
  - **Credential.** Click  to open the Choose Credential dialog box, which enables you to select an existing credential for the probe to use. By default all credentials available for the selected protocol type are selected.

If there is no existing credential, click  to create one.

- **Probe.** Select a probe from the drop-down list of connected probes to ping with UD agent.
- **Timeout (ms).** Frequency (in milliseconds) that the selected probe shall try to ping with UD agent. Default value: 60,000 (ms).
-  **Ping with SNMP.** Displays the SNMP Ping Settings dialog box, which enables you to specify the necessary values to perform a network ping with SNMP.
  - **IP Address.** Select an IP address from the drop-down list of available IP addresses. You can also manually enter the IP address (in IPv4 or IPv6 format) of a target node.
  - **Credential.** Click  to open the Choose Credential dialog box, which enables you to select an existing credential for the probe to use. By default all credentials available for the selected protocol type are selected.

If there is no existing credential, click  to create one.

- **Probe.** Select a probe from the drop-down list of connected probes.
  - **Timeout (ms).** Frequency (in milliseconds) that the selected probe shall try to ping. Default value: 60,000 (ms).
- e. Click **OK** to perform the network ping.



UCMDB server dispatches an ad hoc task to the selected probe, and the probe will ping the target node.

- f. The result pane displays the ping result.

For **IP Ping**, the result is the output of the **ping** command.

For **Ping with UD Agent** or **Ping with SNMP**, the result is either success or failure. An error message follows when the network ping fails.

## How to View Discovery Status and Errors for a Selected CI

As an IT administrator, with the new **View Discovery Status and Error** permission, you are able to run the enhanced **Show Discovery Progress** action in IT Universe Manager. This allows you to,

- **Show Errors.** You can view all error/warning messages during the discovery progress for a selected CI.
- **Show All “<Error Message>” Issues.** Displays all similar discovery issues related to a specific job, thus allowing you to view all CIs impacted by this particular discovery issue.

This enables you to focus on troubleshooting the root cause of the errors and warnings for a particular CI or CIs impacted by a particular discovery issue, without having to access the Universal Discovery module which contains too many unnecessary information. Then you can verify if a CI data error is caused by any discovery issue.

**Note:** Running the **Show Discovery Progress** action in Universal Discovery allows you to view discovery statuses and error/warning messages for all triggered CI instances.

This task includes the following steps:

- [Prerequisites: Grant the Required Permissions](#)
- [View Discovery Status and Errors in IT Universe Manager](#)

### 1. Prerequisites: Grant the Required Permissions

**Note:** This step is performed by the system administrator.

**To view discovery status and errors in IT Universe Manager**, your administrator need to grant the following permissions to you:

- **View Discovery Status and Error**
  - **Show Discovery Status**
- a. Log in to UCMDB and go to **Security > Roles Manager > Roles**.
  - b. Select a role for which you want to assign the required permissions.

Create a new role if you do not have such a role. In this case, **IT Administrator** is created and selected.

**Note:** The **View Discovery Status and Error** permission is not available for all out-of-the-box roles.

- c. In the IT Administrator window, go to the General Actions tab, select the **View Discovery Status and Error** action in the Available Actions pane and move it the Selected Actions pane.
- d. Go to the Resources tab, select **CIT Menu Items** in the Resource Types pane, select **ConfigurationItem** CI type in the Resources pane, and then select **Show Discovery Status** in the Available Actions pane and move it the Selected Actions pane.

**To view all discovery status and errors in Universal Discovery**, you also need the access to the **Universal Discovery** module.

- a. Enable the **View Discovery Status and Error** and **Show Discovery Status** permissions by following the instructions above.
- b. Go to the Resources tab, select **UI Modules** in the Resource Types pane, and then select and move **Universal Discovery** to the Selected UI Modules with Permissions pane.

## 2. **View Discovery Status, Errors, and Warnings for a Selected CI in IT Universe Manager**

- a. Log in to UCMDB with the new role IT Administrator, go to **Modeling > IT Universe Manager**.
- b. In the CI Selector pane, go to the **Search CIs** tab, click the **Start the Search**  icon for the **CI Name** field.
- c. From the returned results, select a discovered node to allow the page to load.

- d. Right click the discovered node, select **Actions > Show Discovery Progress**.

The Discovery Progress dialog box pops up and loads discovery statistics.

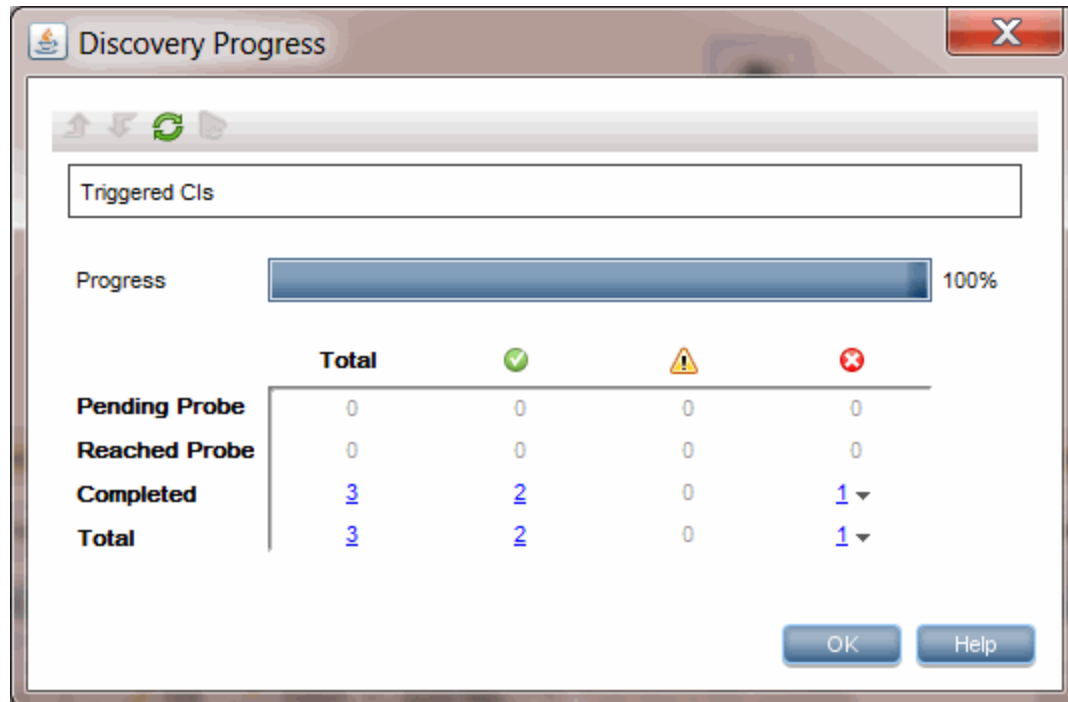

- e. In the CI Instances table,

- Click the link in the column and select **Show errors**.
- Click the link in the column and select **Show warnings**.

The Discovery Progress dialog loads error or warning messages that are related to the selected node.

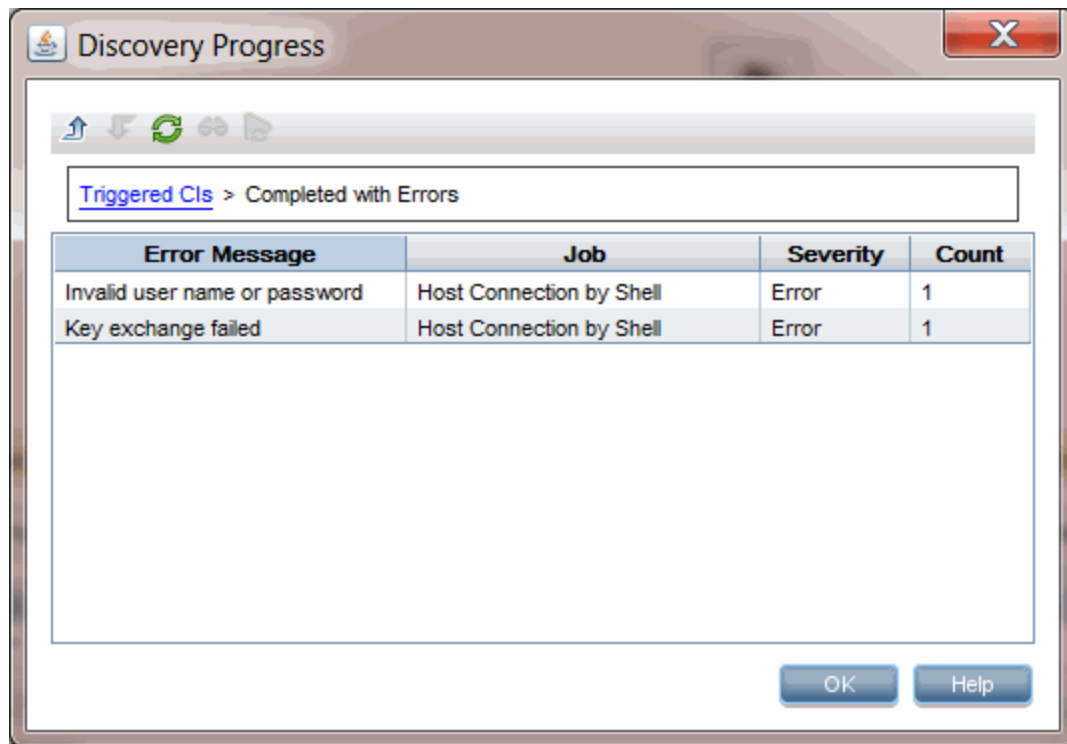

- f. To view details of an error/warning message entry, double-click the error/warning message, or, select it and click the **Show Triggered Cls**  icon.

Detailed error/warning messages occurred during the discovery progress for the particular pair of error message and job you selected are displayed.

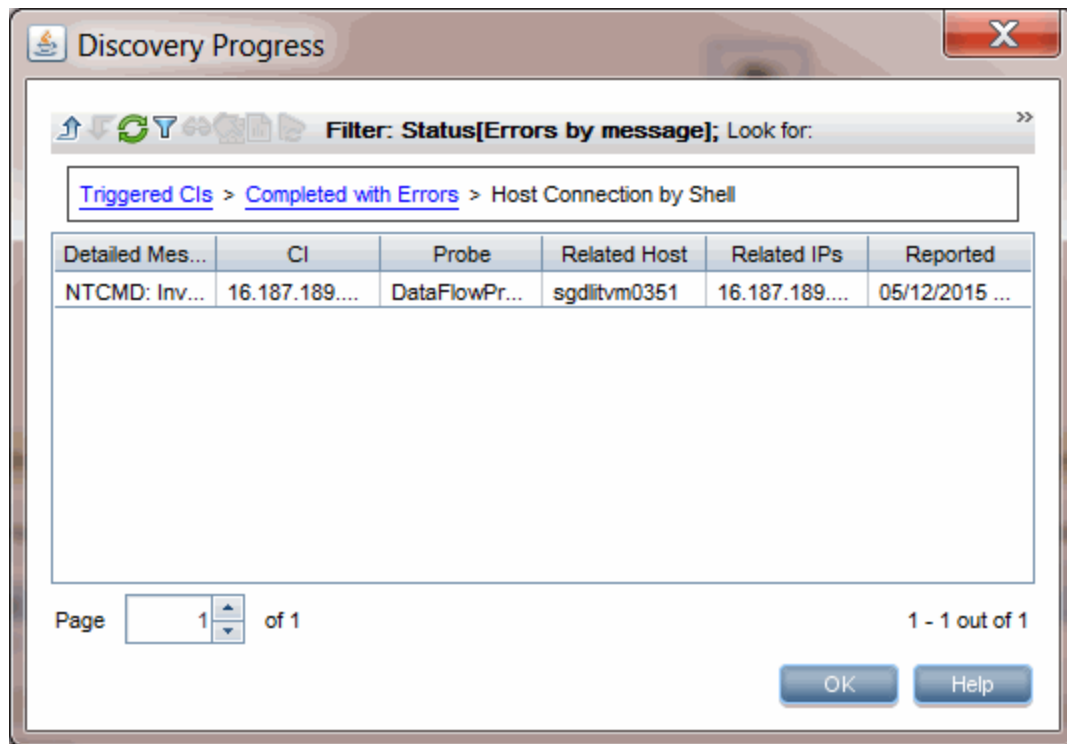

- g. To view all CIs impacted by a particular discovery issue,
  - i. Go back to the Completed with Errors page by clicking **Up One Level** .
  - ii. Right-click the error/warning message of your interest and select **Show All <Error Message> Issues**.

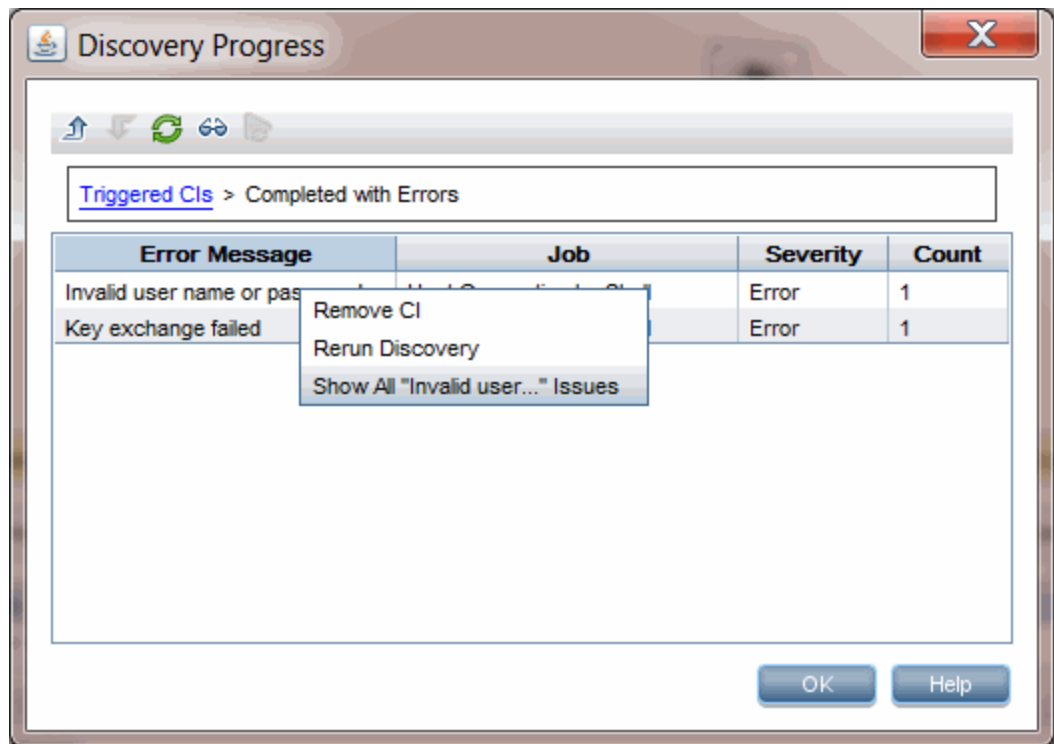

iii. All CIs impacted by this particular discovery issue are displayed.

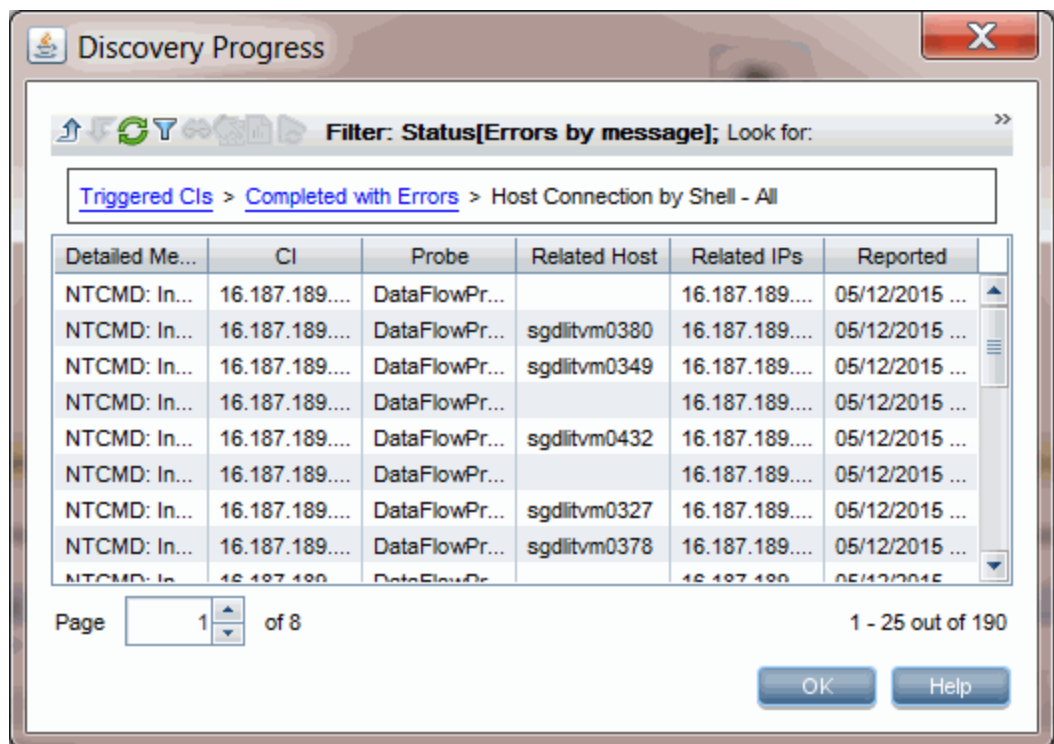

## How to Retrieve Impact Analysis Results – Scenario

Impact Analysis Manager enables you to create an Impact rule that allows you to simulate the impact certain infrastructure changes have on your system. The results of the Impact rule are displayed in IT Universe Manager. The Impact Analysis results in this task describe how a change in CPU operation impacts the node to which it is connected.

This task includes the following steps:

- ["Define an Impact Analysis TQL Query " below](#)
- ["Define an Impact Rule" on the next page](#)
- ["Create a View in the Modeling Studio" on page 209](#)
- ["Get Impact Analysis Results" on page 209](#)

### 1. Define an Impact Analysis TQL Query

To define an Impact Analysis TQL query, you need to create an Impact rule and then add the TQL query nodes and relationships that define the query.

To create an Impact Analysis TQL query, select **Managers > Modeling > Impact Analysis Manager**. For details about how to add query nodes and relationships to a query, see ["How to Add Query Nodes and Relationships to a TQL Query" on page 26](#).

#### Example of an Impact Analysis TQL Query:

In this Impact Analysis TQL query, a CPU and a node are linked by a Composition relationship.

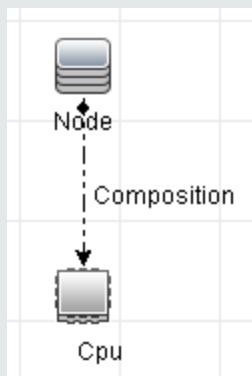

## 2. Define an Impact Rule

When you define an Impact rule, you must specify the required causal relationship between the query nodes. Define one query node as the trigger, or the query node that represents the changes you want to make to the system, and another query node as the one that is impacted.

Right-click the query node you want to define as the trigger and select **Define Impacted** to open the Impacted Query Nodes dialog box. Select the query node that you want the trigger query node to impact and click **Next**. Then click the **Add** button to open the Impact Rules Definition dialog box to set conditions for defining impacted query nodes. For details about how to define an Impact rule, see ["Impact Rules Definition Dialog Box" on page 479](#).

**Note:** The **change** state option in the Impact rule definition is no longer relevant for Impact Analysis. The only supported state is **operation**.

### Example of an Impact Rule:

The Conditions area in the Impact Rules Definition dialog box defines the conditions under which the simulated change in the system is triggered. The Severity area defines the severity of the impact on the impacted query node.

The Impact rule in this example states that when the CPU operation is not in the normal state, the node is impacted. Since the severity is set to 100% of the trigger's severity, the severity of the node is the same as the severity of the CPU, which is determined when Impact Analysis is run.



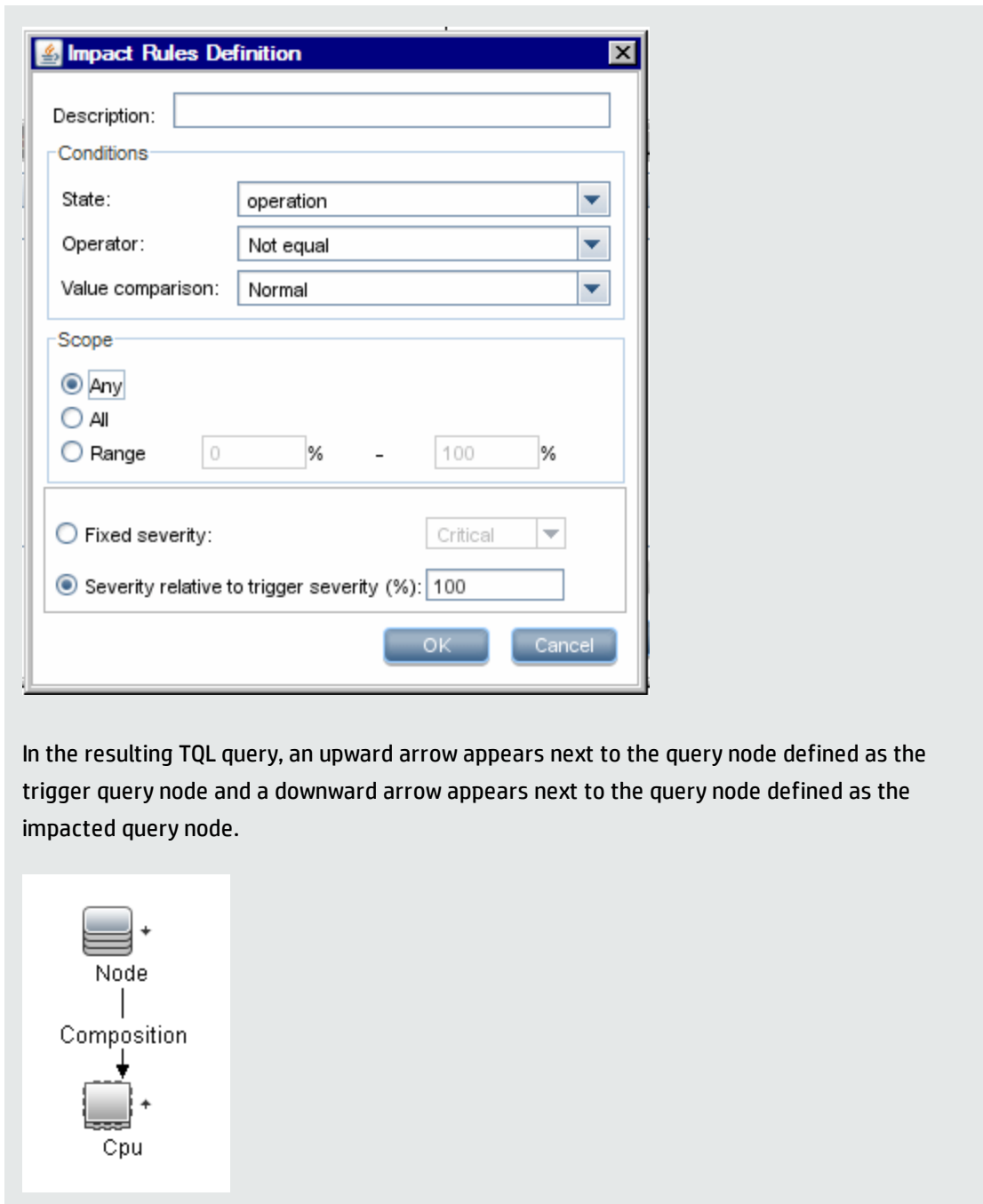

In the resulting TQL query, an upward arrow appears next to the query node defined as the trigger query node and a downward arrow appears next to the query node defined as the impacted query node.

### 3. Create a View in the Modeling Studio

Go to the Modeling Studio and create a view matching the TQL query of the Impact rule you defined. For details, see ["Pattern View Editor" on page 321](#).

### 4. Get Impact Analysis Results

Select **Managers > Modeling > IT Universe Manager** and select the required view in the CI Selector. To get Impact Analysis results, run the Impact rule on a CI instance in the topology map that is a trigger. Right-click a trigger CI and select **Run Impact Analysis** to open the Run Impact Analysis dialog box. In the dialog box, select the Impact rules to run. If you want to select Only Impact rules located in specified bundle, make sure to add your Impact rule to the required bundle using the Properties option for the selected Impact rule. For details, see "[Impact Rule Groups Page](#)" on page 483.

For details on how to run an Impact rule, see "[Run Impact Analysis Dialog Box](#)" on page 247.

**Example for Getting Impact Analysis Results:**

An Impact Analysis TQL query is created containing a CPU and node connected by a Composition relationship. The CPU query node is defined as the trigger query node and the query node of type node is defined as the impacted query node.

The following Impact rule is defined for the query.

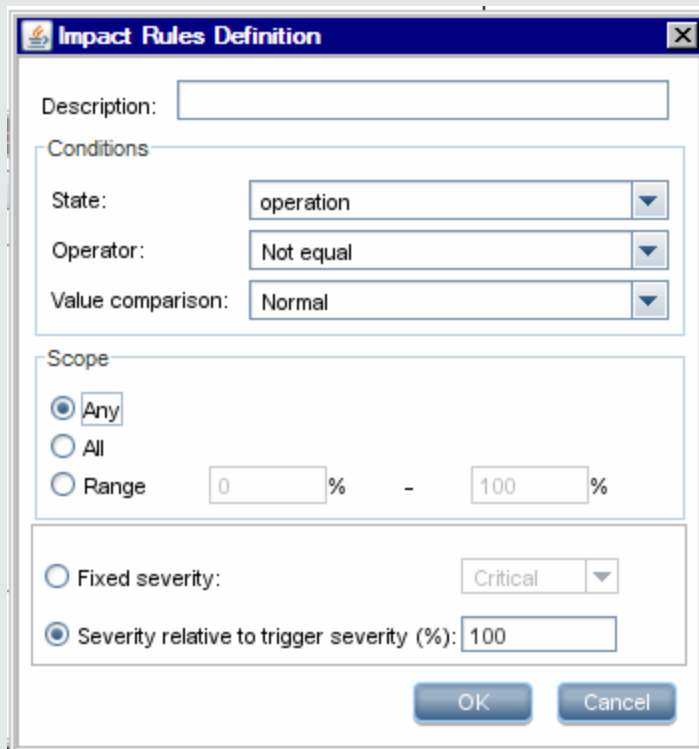

Right-click a CPU CI in the view, and select **Run Impact Analysis** to open the Run Impact Analysis dialog box. Set the trigger severity to a value other than **Normal**.

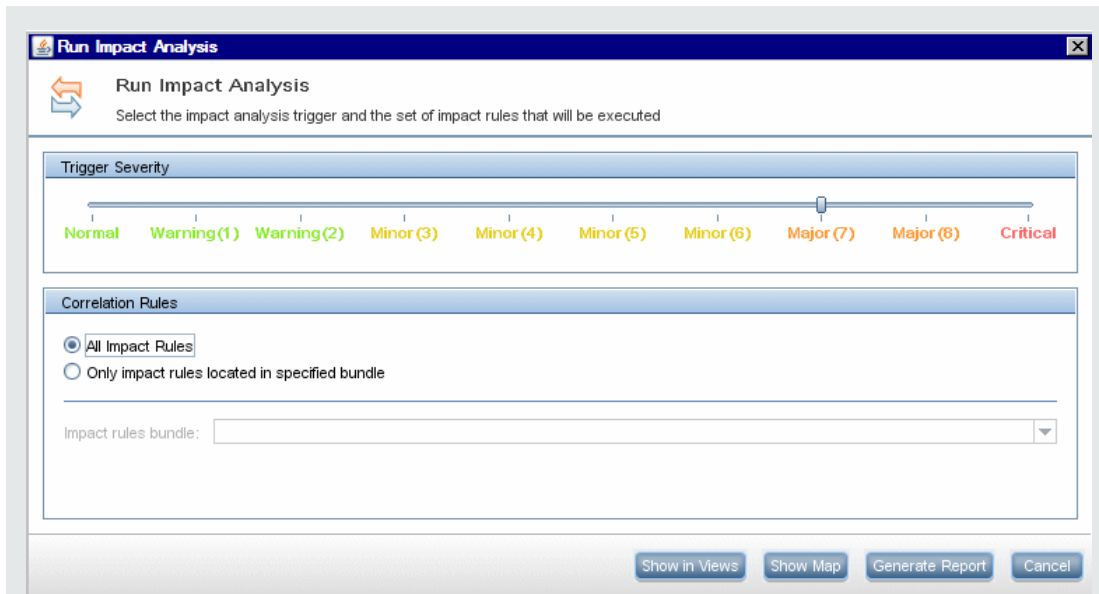

To see results, click one of the following:

- **Show in Views.** This assigns a status to all the CIs in the view. Only the node CI connected to the CPU CI (whose severity was changed), becomes impacted. The trigger CI and the impacted CI turn orange because the trigger severity was set as **Major (7)** on the scale in the Run Impact Analysis dialog box, which is assigned an orange color.

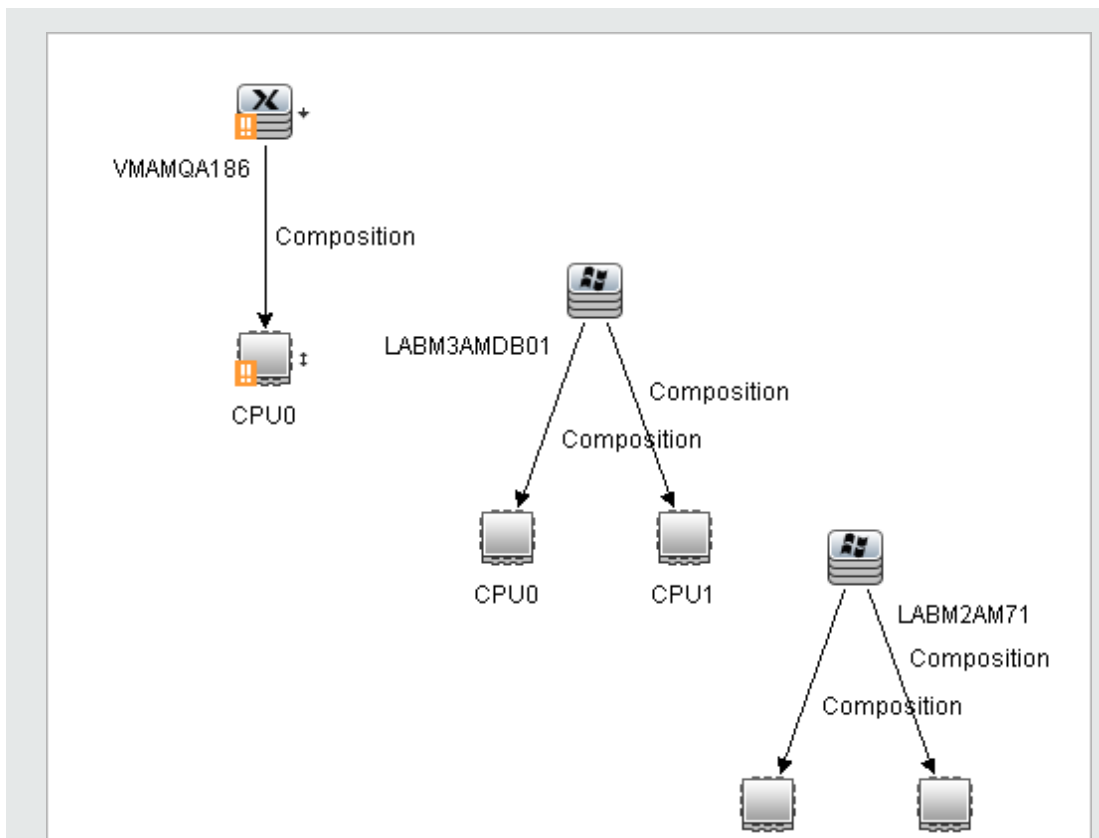

- **Show Map.** A map appears in a separate window containing only the trigger CPU CI and the node CI it impacted. The relationship connecting the two CIs contains the name of the Impact rule defined in Impact Analysis Manager.

**Note:** Optionally, you can create a URL that enables you to embed the map. For details, see ["Direct Link Parameters – Impact Map Page"](#) on page 114.

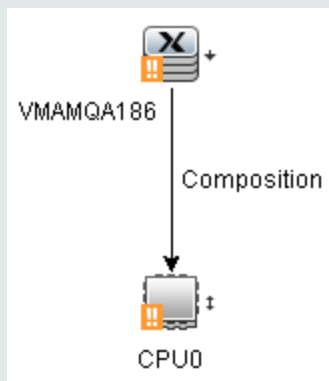

- **Generate Report.** Generates an Impact Analysis report that displays a list of CIs that are impacted in the system as a result of the simulated changes. For details, see ["Run Impact Analysis Dialog Box" on page 247.](#)

## How to Take a Snapshot of a View

You can take a snapshot of a view in IT Universe Manager, save it, and then compare snapshots of the same view taken at different times using the Compare Snapshots Report. For details on how to take a snapshot of a view, see ["Save Snapshot Dialog Box" on page 249.](#) For details on how to view actual differences in the compared views, see ["Compare Snapshots Report" on page 395.](#)

## How to Print and Save a Topology Map to File

You can print the content of any topology map and then save it to file. Before printing, it is recommended to define your print settings and arrange the contents of the topology map according to your requirements. For details on how to define print settings, see ["Print Setup Dialog Box" on page 166.](#) For details on how to preview the content of the topology map before printing, see ["Print Preview Dialog Box" on page 166.](#) For details on how to print the content of a topology map, see ["Print Dialog Box" on page 165.](#) For details on how to save a topology map to file, see ["Export Map to Image Dialog Box" on page 150.](#)

## IT Universe Manager User Interface

This section includes (in alphabetical order):

Add CIs to Model Dialog Box .....	214
Add CIs to View Dialog Box .....	215
Change Timeframe Dialog Box .....	215
Check Network Availability Dialog Box .....	216
CI/Relationship History Dialog Box .....	218
Configuration Item Properties Dialog Box .....	220
Generate Sub Report Dialog Box .....	225

Get Related CIs From CMDB Dialog Box .....	226
Insert Relationship Dialog Box .....	226
IT Universe Manager Page .....	230
New CI/New Related CI Dialog Box .....	242
Recently Discovered By Dialog Box .....	247
Run Impact Analysis Dialog Box .....	247
Save Snapshot Dialog Box .....	249
Show Discovery Status and Changes Dialog Box .....	250
Show Impact Pane .....	251

## Add CIs to Model Dialog Box

This dialog box enables you to add selected CIs to a model.

<b>To access</b>	Select <b>Managers &gt; Modeling &gt; IT Universe Manager</b> . Right-click a CI or multiple CIs in the CI Selector and select <b>Add CIs to Model</b> .
<b>Important information</b>	This feature is only relevant for instance based models. You cannot add selected CIs to a pattern based model.
<b>See also</b>	<ul style="list-style-type: none"> <li>• <a href="#">"IT Universe Manager Overview" on page 181</a></li> <li>• <a href="#">"IT Universe Manager User Interface" on the previous page</a></li> <li>• <a href="#">"Business CI Models" on page 262</a></li> </ul>

User interface elements are described below:

UI Element (A-Z)	Description
<b>&lt;Model tree&gt;</b>	When <b>Existing Model</b> is selected, select a model from the tree.
<b>Define New CI Properties</b>	When <b>New Model</b> is selected, define the name and properties of the model.
<b>Existing Model</b>	Select <b>Existing Model</b> to add the selected CIs to an existing model.
<b>New Model</b>	Select <b>New Model</b> to add the selected CIs to a new model.
<b>Select CI Type</b>	When <b>New Model</b> is selected, select a CI type for the model.

## Add CIs to View Dialog Box

This dialog box enables you to add selected CIs to a perspective-based view.



<b>To access</b>	Select <b>Managers &gt; Modeling &gt; IT Universe Manager</b> . Right-click a CI or multiple CIs in the CI Selector and select <b>Add CIs to View</b> .
<b>See also</b>	<ul style="list-style-type: none"> <li>• <a href="#">"IT Universe Manager Overview" on page 181</a></li> <li>• <a href="#">"Working with Views in IT Universe Manager" on page 182</a></li> <li>• <a href="#">"IT Universe Manager User Interface" on page 213</a></li> </ul>

User interface elements are described below:



<b>UI Element (A-Z)</b>	<b>Description</b>
<b>&lt;View tree&gt;</b>	When <b>Existing View</b> is selected, select a view from the tree.
<b>Existing View</b>	Select <b>Existing View</b> to add the selected CIs to an existing perspective-based view.
<b>New View</b>	Select <b>New View</b> to add the selected CIs to a new perspective-based view.
<b>View Name</b>	When <b>New View</b> is selected, edit the name of the view.

## Change Timeframe Dialog Box

This dialog box enables you to display changes in the topology map and set the time frame for the changes to display.

<b>To access</b>	Select <b>Managers &gt; Modeling &gt; IT Universe Manager</b> . Click the <b>Set Change Timeframe</b>  button on the main toolbar or the IT Universe status bar.
<b>Important information</b>	<p>When the change indicators are displayed in the topology map, a message appears on the IT Universe status bar <b>Change Timeframe is Active</b>.</p> <p>To hide the indicators, open the dialog box and select <b>Do not display changes</b>, or click the <b>Reset Change Timeframe</b>  button on the IT Universe status bar.</p>
<b>See also</b>	<ul style="list-style-type: none"> <li>• <a href="#">"IT Universe Manager Overview" on page 181</a></li> <li>• <a href="#">"IT Universe Manager User Interface" on page 213</a></li> </ul>

User interface elements are described below:

UI Element (A-Z)	Description
<p><b>Display changes according to the selected timeframe</b></p>	<p>Select this option to display an indicator next to each CI that was added or changed within the selected period as follows:</p> <ul style="list-style-type: none"> <li>•  Indicator for an added CI</li> <li>•  Indicator for a changed CI</li> </ul> <p>Select a time period from the drop-down list. If you select <b>Custom</b>, click the ellipsis  button to select the <b>Date From</b> and <b>Date Until</b> fields. The changes to the CIs of the view within the selected period are displayed in the map.</p> <p>When the indicators are displayed, you can click the indicator to open the CI History dialog box, which displays the history for the CI over the selected period.</p>
<p><b>Do not display changes</b></p>	<p>Select this option to hide the change indicators.</p>





## Check Network Availability Dialog Box



This dialog box displays the result returned from performing IP ping, UD agent ping, or SNMP ping against a selected inventory CI of the **Node** CI type.

<p><b>To access</b></p>	<p>Use one of the following:</p> <ul style="list-style-type: none"> <li>• In IT Universe Manager, go to the <b>CI Selector</b> pane &gt; <b>Search CIs</b> tab &gt; search for Node type CIs &gt; right-click an inventory CI from the returned result and select <b>Actions &gt; Check Network Availability</b> from the shortcut menu.</li> <li>• In the CI Instances dialog box, right-click an inventory CI instance, click <b>Actions</b>, and select <b>Check Network Availability</b>. For information about the CI Instances dialog box, see <a href="#">CI Instances Dialog Box</a> in the <i>HP Universal CMDB Modeling Guide</i>.</li> </ul>
<p><b>Important information</b></p>	<ul style="list-style-type: none"> <li>• The <b>Check Network Availability</b> option is only available in the <b>Actions</b> list for a selected inventory CI of the <b>Node</b> CI type.</li> <li>• The <b>Check Network Availability</b> option is only available with Content Pack 16.00.</li> </ul>
<p><b>Relevant tasks</b></p>	<p><a href="#">How to Check the Network Availability of an Inventory CI</a></p>

User interface elements are described below:



UI Element (A-Z)	Description
<b>Name</b>	Name of the selected <b>Node</b> type inventory CI.
<b>ID</b>	ID of the selected <b>Node</b> type inventory CI.
<b>CI Type</b>	Subtype of the selected <b>Node</b> type inventory CI.
	<p><b>IP Ping.</b> Displays the IP Ping Settings dialog box, which enables you to specify the following values to perform a network IP ping:</p> <ul style="list-style-type: none"> <li>• <b>IP Address.</b> Select the IP address of your target node (in IPv4 or IPv6 format) from the drop-down list of available IP addresses. You can also manually enter the IP address (in IPv4 or IPv6 format) of a target node.</li> <li>• <b>Probe.</b> Select a probe from the drop-down list of connected probes to perform IP ping.</li> <li>• <b>Ping Times.</b> Number of attempts for the selected probe to perform IP ping. Default value: 4.</li> <li>• <b>Timeout (ms).</b> Frequency (in milliseconds) that the selected probe shall try to perform IP ping. Default value: 60,000 (ms).</li> </ul>
	<p><b>Ping with UD Agent.</b> Displays the UD Agent Ping Settings dialog box, which enables you to specify the following values to perform a network ping with UD agent:</p> <ul style="list-style-type: none"> <li>• <b>IP Address.</b> Select an IP address from the drop-down list of available IP addresses. You can also manually enter the IP address (in IPv4 or IPv6 format) of a target node.</li> <li>• <b>Credential.</b> Click  to open the Choose Credential dialog box, which enables you to select an existing credential for the probe to use. By default all credentials available for the selected protocol type are selected.</li> </ul> <p>If there is no existing credential, click  to create one.</p> <ul style="list-style-type: none"> <li>• <b>Probe.</b> Select a probe from the drop-down list of connected probes to ping with UD agent.</li> <li>• <b>Timeout (ms).</b> Frequency (in milliseconds) that the selected probe shall try to ping with UD agent. Default value: 60,000 (ms).</li> </ul>
	<p><b>Ping with SNMP.</b> Displays the SNMP Ping Settings dialog box, which enables you to specify the following values to perform a network ping with SNMP:</p> <ul style="list-style-type: none"> <li>• <b>IP Address.</b> Select an IP address from the drop-down list of available IP addresses. You can also manually enter the IP address (in IPv4 or IPv6 format) of a target node.</li> </ul>

UI Element (A-Z)	Description
	<ul style="list-style-type: none"> <li>• <b>Credential.</b> Click  to open the Choose Credential dialog box, which enables you to select an existing credential for the probe to use. By default all credentials available for the selected protocol type are selected.</li> </ul> <p>If there is no existing credential, click  to create one.</p> <ul style="list-style-type: none"> <li>• <b>Probe.</b> Select a probe from the drop-down list of connected probes to ping with UD agent.</li> <li>• <b>Timeout (ms).</b> Frequency (in milliseconds) that the selected probe shall try to ping with UD agent. Default value: 60,000 (ms).</li> </ul>
<b>&lt;Result Pane&gt;</b>	<p>Displays the result returned by the selected probe after performing IP ping, UD agent ping, or SNMP ping against a selected inventory CI of the <b>Node CI</b> type.</p> <p>For <b>IP Ping</b>, the result is the output of the <b>ping</b> command.</p> <p>For <b>Ping with UD Agent</b> or <b>Ping with SNMP</b>, the result is either success or failure. An error message follows when the network ping fails.</p>



## CI/Relationship History Dialog Box

This dialog box displays a list of CI or relationship attributes in which changes have occurred as well as the differences between two configuration files.

<b>To access</b>	<p>In IT Universe Manager, right-click the selected CI or relationship in the CI Selector or the Topology Map and select <b>CI History</b>.</p> <div data-bbox="406 1396 1372 1512" style="background-color: #f0f0f0; padding: 5px;"> <p><b>Note:</b> CI and relationship history data is also available in the History tab of the Advanced pane in IT Universe Manager.</p> </div>
<b>Important information</b>	<p>All CI and relationship attributes are included in the History, except for attributes marked with the <b>Not Tracked for History</b> qualifier in the CI Type Manager. For details, see <a href="#">"Add/Edit Attribute Dialog Box"</a> on page 497.</p> <div data-bbox="406 1669 1372 1848" style="background-color: #f0f0f0; padding: 5px;"> <p><b>Note:</b> In a multi-tenancy environment, the CI History dialog box only displays history events that are relevant to the tenants associated with your <b>View CIs</b> permission. However, <b>Remove CI/relationship</b> events that occurred before an upgrade to UCMDB version 10.01 are displayed independent of the tenants</p> </div>

	associated with the <b>View CIs</b> permission.
<b>See also</b>	<ul style="list-style-type: none"> <li>• <a href="#">"IT Universe Manager Overview" on page 181</a></li> <li>• <a href="#">"IT Universe Manager User Interface" on page 213</a></li> </ul>

User interface elements are described below:

UI Element (A-Z)	Description
	<p><b>Refresh.</b> Refreshes the data in the table.</p>
	<p><b>Show Difference.</b> Enables you to view the difference between two history entries for the content of a configuration file. This is relevant in the following situations:</p> <ul style="list-style-type: none"> <li>• Select two history entries for the <b>Document Content</b> attribute for CIs of the type <b>Configuration Document</b> to compare to each other.</li> <li>• Select one history entry for the <b>Document Content</b> attribute for CIs of the type <b>Configuration Document</b> to compare to the current content for that CI.</li> </ul> <p>Click the <b>Show difference</b> button to open the Visualdiff report, which displays a comparison of the two entries. Text added to the second entry appears highlighted in yellow. Text removed from the first entry appears highlighted in red. Differences between the entries appear highlighted in green.</p>
	<p><b>Export Data To File.</b> Enables you to export the history data. Choose the export format from the following options:</p> <ul style="list-style-type: none"> <li>• <b>XLS.</b> The table data is formatted as an .xls (Excel) file that can be displayed in a spreadsheet.</li> <li>• <b>PDF.</b> The table data is exported in PDF format.</li> </ul> <div style="background-color: #f0f0f0; padding: 5px; margin: 10px 0;"> <p><b>Note:</b> When exporting to PDF, select a reasonable number of columns to display to ensure that the report is legible.</p> </div> <ul style="list-style-type: none"> <li>• <b>RTF.</b> The table data is exported in Rich Text Format.</li> <li>• <b>CSV.</b> The table data is formatted as a comma-separated values</li> </ul>



UI Element (A-Z)	Description
	<p>(CSV) text file that can be displayed in a spreadsheet.</p> <div style="border: 1px solid #ccc; padding: 5px; margin: 10px 0;"> <p><b>Note:</b> For the CSV formatted table data to display correctly, the comma (,) must be defined as the list separator. In Windows, to verify or modify the list separator value, open Regional Options from the Control Panel, and on the Numbers tab ensure that the comma is defined as the List Separator value. In Linux, you can specify the list separator in the application that opens the CSV file.</p> </div> <ul style="list-style-type: none"> <li>• <b>XML.</b> The table data is formatted as an XML file that can be opened in a text or XML editor.</li> </ul> <div style="border: 1px solid #ccc; padding: 5px; margin: 10px 0;"> <p><b>Tip:</b> To extract HTML code from the report:</p> <ul style="list-style-type: none"> <li>• Open the file in an HTML editor</li> <li>• Copy the relevant table into the target file</li> </ul> </div>
<b>Attribute</b>	The name of the attribute.
<b>Change Date</b>	The date when the last change occurred.
<b>Filter by</b>	<p>Filter the data in the table by one or more of the following filters:</p> <ul style="list-style-type: none"> <li>• <b>Time Range.</b> Select the time period for which the CI history is displayed.</li> <li>• <b>Change Type.</b> Select the type of changes displayed in the table.</li> <li>• <b>Attribute.</b> Select the attribute types displayed in the table.</li> </ul>
<b>Modified By</b>	Indicates the cause of the change. For example, the field can contain the name of a user or a DFM job.
<b>New Value</b>	The new value of the attribute.
<b>Old Value</b>	The previous value of the attribute.





## Configuration Item Properties Dialog Box

This dialog box enables you to view and edit basic information for an existing CI or relationship.

<p><b>To access</b></p>	<p>Select <b>Managers &gt; Modeling &gt; IT Universe Manager</b> and use one of the following:</p> <ul style="list-style-type: none"> <li>• Select a CI or relationship in the topology map or a CI in the CI Selector. In the Advanced Pane, select the <b>Properties</b> tab and click <b>Edit</b>.</li> <li>• Select a CI or relationship in the topology map or a CI the CI Selector and click the <b>Show CI Properties</b>  button.</li> <li>• Right-click a CI or relationship in the Topology map or a CI in the CI Selector and select <b>Properties</b>.</li> </ul>
<p><b>Important information</b></p>	<p>The Configuration Item Properties dialog box contains two types of properties:</p> <ul style="list-style-type: none"> <li>• General properties, which include general information about the CI or relationship. These properties are common to all CITs and are documented below.</li> <li>• CIT-specific properties, which include properties specific to that CI. These properties vary according to the type of CI or relationship and are not documented.</li> </ul> <p>When you sort the properties by category, the CIT-specific properties appear at the top of the list and the general properties appear at the bottom.</p> <p>You can view a description of the selected property in the Description Area at the bottom of the dialog box. Click the <b>Show/Hide Description Area</b> button to display the Description Area.</p> <p>Mandatory fields are marked with an asterisk (*).</p> <div style="background-color: #f0f0f0; padding: 5px; margin-top: 10px;"> <p><b>Note:</b> HP Universal CMDB does not fully support surrogate pairs and combining characters.</p> </div>
<p><b>See also</b></p>	<ul style="list-style-type: none"> <li>• CI Lifecycle and the Aging Mechanism in the <i>HP Universal CMDB Administration Guide</i></li> <li>• <a href="#">"Working with CIs" on page 185</a></li> <li>• <a href="#">"IT Universe Manager User Interface" on page 213</a></li> </ul>

User interface elements are described below (unlabeled elements are shown in angle brackets>):

<p><b>UI Element (A-Z)</b></p>	<p><b>Description</b></p>
	<p><b>Categorized.</b> Displays the properties by category.</p>
	<p><b>Alphabetic.</b> Displays the properties alphabetically.</p>

UI Element (A-Z)	Description
	<b>Show/Hide Description Area.</b> Toggles between showing and hiding the description area at the bottom of the CI Properties dialog box.
	<b>Expand.</b> Expands the properties tree when the properties are displayed by category.
	<b>Collapse.</b> Collapses the properties tree when the properties are displayed by category.
 Export ▾	<p><b>Export Data To File.</b> Enables you to export the table data. Choose the export format from the following options:</p> <ul style="list-style-type: none"> <li>• <b>Excel.</b> The table data is formatted as an .xls (Excel) file that can be displayed in a spreadsheet.</li> <li>• <b>PDF.</b> The table data is exported in PDF format.                             <div data-bbox="448 842 1369 957" style="background-color: #f0f0f0; padding: 5px; margin: 5px 0;"> <p><b>Note:</b> When exporting to PDF, select a reasonable number of columns to display to ensure that the report is legible.</p> </div> </li> <li>• <b>RTF.</b> The table data is exported in Rich Text Format.</li> <li>• <b>CSV.</b> The table data is formatted as a comma-separated values (CSV) text file that can be displayed in a spreadsheet.                             <div data-bbox="448 1167 1369 1430" style="background-color: #f0f0f0; padding: 5px; margin: 5px 0;"> <p><b>Note:</b> For the CSV formatted table data to display correctly, the comma (,) must be defined as the list separator. In Windows, to verify or modify the list separator value, open Regional Options from the Control Panel, and on the Numbers tab ensure that the comma is defined as the List Separator value. In Linux, you can specify the list separator in the application that opens the CSV file.</p> </div> </li> <li>• <b>XML.</b> The table data is formatted as an XML file that can be opened in a text or XML editor.                             <div data-bbox="428 1570 1369 1776" style="background-color: #f0f0f0; padding: 5px; margin: 5px 0;"> <p><b>Tip:</b> To extract HTML code from the report:</p> <ul style="list-style-type: none"> <li>○ Open the file in an HTML editor</li> <li>○ Copy the relevant table into the target file</li> </ul> </div> </li> </ul>
<b>&lt;Quick filter&gt;</b>	Enter a string in the Quick filter box to filter the property names and values. Click the left end of the box to open the drop-down menu of filter options:

UI Element (A-Z)	Description
	<ul style="list-style-type: none"> <li>• Select <b>All</b> to search for the filter string in both property names and property values. Select <b>Name</b> to search for the filter string in property names only. Select <b>Value</b> to search for the filter string in property values only.</li> <li>• Select <b>Case sensitive</b> to search for the filter string exactly as entered. Select <b>Case insensitive</b> to ignore the case of the filter string.</li> <li>• Select <b>Use wild cards</b> to use the wildcard symbol * in the filter string.</li> <li>• Select <b>Match from start</b> to search for the filter string at the beginning of a property name or value. Select <b>Match exactly</b> to search for the exact filter string. Select <b>Match anywhere</b> to search for the filter string anywhere in the properties.</li> </ul>
<b>Actual Deletion Period</b>	The number of days after which the CI or relationship is deleted.
<b>Allow CI Update</b>	<p>When selected, this option allows the DFM process to automatically update the CI or relationship properties with information that it discovers. If you change the value of a property supplied by the DFM process, the value is overridden by the discovered value.</p> <p>When this option is cleared, the CI or relationship properties are not overridden by the DFM process.</p>
<b>Apply</b>	Click <b>Apply</b> to save the changes made to the CI or relationship properties.
<b>CI Type</b>	The type of the CI or relationship (read-only value). For information about CITs in HP Universal CMDB, see " <a href="#">CI Type Manager</a> " on page 485.
<b>Created By</b>	The user name of the administrator who manually created the CI or relationship, where applicable (read-only value).
<b>Create Time</b>	The date and time when the CI or relationship was created.
<b>Deletion Candidate Period</b>	The period after which the CI becomes a candidate for deletion when the aging mechanism is enabled.
<b>Description</b>	A brief description of the CI or relationship.
<b>Display Label</b>	The name of the CI or relationship as it appears in the CI Selector.
<b>Edit</b>	In the Properties tab of the Advanced pane, you can view a CI's properties but you

UI Element (A-Z)	Description
	cannot edit them. Click <b>Edit</b> to open the Configuration Item Properties dialog box where you can edit the properties.
<b>Enable Aging</b>	<p>If a CI or relationship is not updated or refreshed over a period of time (for example, a CI is not rediscovered by DFM and no manual update occurs), an aging mechanism deletes the CI from the CMDB. For details, see The Aging Mechanism Overview in the <i>HP Universal CMDB Administration Guide</i>.</p> <p><b>True:</b> the aging mechanism is enabled for this CI or relationship.</p> <p><b>False:</b> the aging mechanism is disabled for this CI or relationship.</p> <div data-bbox="407 716 1369 1031" style="background-color: #f0f0f0; padding: 10px;"> <p><b>Note:</b></p> <ul style="list-style-type: none"> <li>• If the aging mechanism is disabled in Aging Status, this field is ignored.</li> <li>• This field is displayed for certain CIs only.</li> <li>• The default value is determined by the default value of the <b>Enable Aging</b> attribute for the CI type of the selected CI.</li> </ul> </div>
<b>Global Id</b>	The internal ID of the CI or relationship in the CMDB (read-only value).
<b>Last Access Time</b>	<p>The time that the CI or relationship was last accessed, whether when being updated or being discovered by DFM. This field is only displayed for certain CIs or relationships.</p> <p>This parameter is used by the aging mechanism. For details, see CI Lifecycle and the Aging Mechanism in the <i>HP Universal CMDB Administration Guide</i>.</p> <div data-bbox="407 1304 1369 1577" style="background-color: #f0f0f0; padding: 10px;"> <p><b>Note:</b> By default, this property is updated every time the CI is touched by a running discovery job or integration. To prevent this property from being updated by a discovery job or integration, go to the Data Flow Management module, and in the <b>Adapter Management &gt; Adapter Configuration</b> tab, clear the <b>Update last access time</b> option. For more details, see Adapter Configuration Tab in the <i>HP Universal CMDB Data Flow Management Guide</i>.</p> </div>
<b>Last Modified Time</b>	The date and time when the CI or relationship properties were last updated.
<b>Name</b>	The name of the CI or relationship.
<b>Note</b>	Enables you to enter other information about the CI or relationship.



UI Element (A-Z)	Description
<b>Origin</b>	An ID for the source that automatically created the CI or relationship, or the application where the CI or relationship was created (read-only value).
<b>Reset</b>	Click the <b>Reset</b> button to restore the original property settings of the CI or relationship.
<b>Updated by</b>	The user name of the administrator who updated the CI or relationship properties.
<b>User Label</b>	Enables you to define a display label for the CI or relationship. If no value is entered, the CI name appears as the default label.

### Shortcut Menu

Menu Item	Description
<b>Copy Property Name and Value</b>	Copies the name and value of the selected property to the memory.

## Generate Sub Report Dialog Box

This dialog box enables you to generate a Sub Report for the selected CI.

<b>To access</b>	In IT Universe Manager, right-click a CI in the topology map or the CI Selector and select <b>Generate Sub Report</b> .
<b>Important information</b>	A Sub Report enables you to apply a perspective to a selected CI and view the results in report format. Select a perspective from the list and click <b>OK</b> . The Sub Report opens in a separate window.
<b>See also</b>	<ul style="list-style-type: none"> <li>• <a href="#">"IT Universe Manager Overview" on page 181</a></li> <li>• <a href="#">"IT Universe Manager User Interface" on page 213</a></li> </ul>

User interface elements are described below (unlabeled elements are shown in angle brackets):

UI Element (A-Z)	Description
<b>&lt;List of available perspectives&gt;</b>	The list includes only perspectives that are designated as a Sub Report perspective in its Report Properties. Only perspectives matching the selected CI type are displayed.
<b>Description</b>	A description of the selected perspective.

## Get Related CIs From CMDB Dialog Box

This dialog box enables you to view the CIs related to a specified CI in the CMDB in map or table format.

<b>To access</b>	In IT Universe Manager, right-click the required CI and select <b>Get Related CIs</b> .
<b>Important information</b>	<p>The Get Related CIs From CMDB dialog box is a standalone version of the Related CIs tab in IT Universe Manager. You can control the content of the display using the features in the Get Related CIs pane. For details, see <a href="#">"Get Related CIs Pane" on page 240</a>.</p> <p>You cannot select the scope of the related CIs displayed in the Get Related CIs From CMDB dialog box. The scope is the entire CMDB.</p> <div style="background-color: #f0f0f0; padding: 5px; border: 1px solid #ccc;"> <p><b>Note:</b> The text mode format includes the icons found in the CI Instances dialog box. For details, see <a href="#">"CI Instances Dialog Box" on page 66</a>.</p> </div>
<b>Relevant tasks</b>	<a href="#">"How to View Related CIs" on page 194</a>
<b>See also</b>	<ul style="list-style-type: none"> <li>• <a href="#">"IT Universe Manager Overview" on page 181</a></li> <li>• <a href="#">"IT Universe Manager User Interface" on page 213</a></li> </ul>



## Insert Relationship Dialog Box

This dialog box enables you to attach CIs to the CI you selected in the CI Selector.

<b>To access</b>	In IT Universe Manager, right-click a CI in the Topology Map or the CI Selector, and select <b>Relate to CI</b> .
<b>Important information</b>	<p>To create a relationship between two CIs, select the source CI in the CI Selector or the Topology Map and then select <b>Relate to CI</b> from the shortcut menu. On the first page of the dialog box (the CI Selection page), you select the target CI(s). Then click <b>Relationship</b>, to select the relationship type on the second page of the dialog box.</p> <p>You can also create a relationship between two CIs graphically by clicking the <b>Create Relationship</b>  button on the toolbar and drawing a line between the two CIs. In this case, a smaller version of the Insert Relationship dialog box opens, which contains the following tabs:</p> <ul style="list-style-type: none"> <li>• <b>Select Relationship.</b> Displays a tree with the available relationship types. Select the required relationship.</li> </ul>

	<p><b>Note:</b> You can double-click the relationship you select to save using the default properties.</p> <ul style="list-style-type: none"> <li>• <b>Relationship Properties.</b> Displays the properties of the selected relationship. You can edit the properties as described in <a href="#">"Define Relationship Properties Pane" on the next page.</a></li> </ul>
<b>Relevant tasks</b>	<a href="#">"How to Create CIs and Relationships" on page 194</a>
<b>See also</b>	<ul style="list-style-type: none"> <li>• <a href="#">"CI Selector" on page 135</a></li> <li>• <a href="#">"Relationship Page" below</a></li> </ul>

User interface elements are described below:

UI Element (A-Z)	Description
	Adds the selected CIs in the left pane to the Target CIs pane.
	Removes the selected CIs from the Target CIs pane (this does not delete the CIs from the CMDB).
<b>Select target CIs</b>	<p>Select a view to display in the view tree and select CIs to move to the Target CIs pane.</p> <p>For details on the <b>Select target CIs</b> pane, see <a href="#">"CI Selector" on page 135.</a></p>
<b>Source CI</b>	The CI you selected as the source CI.
<b>Target CIs</b>	Displays the CIs you have selected as target CIs for the relationship.

## Relationship Page

This page enables you to define the relationship to be created between the original CI and the CIs selected on the CI Selection page of the dialog box.

<b>To access</b>	Click the <b>Relationship</b> button from the Insert Relationship dialog box.
<b>Important information</b>	When defining multiple relationships, you can define different descriptions and property values for each relationship. Skip the property definitions here and edit each relationship individually after it is created.

User interface elements are described below:

### Select Relationship Pane

UI Element (A-Z)	Description
<b>Direction</b>	Select the direction of the relationship.  For some relationship types (for example, <b>Composition</b> , or between a group CI and a monitor CI), only one direction is valid.
<b>Relationship</b>	Define the type of relationship created between the original CI and the CIs being attached. Select an option from the list.
<b>Source CI</b>	Displays the name of the CI on the first end of the relationship. This is the CI that you selected in the view.
<b>Target CI</b>	Displays the name of the CI on the second end of the relationship, that is attached to the original CI.

### Define Relationship Properties Pane

UI Element (A-Z)	Description
<b>Actual Deletion Period</b>	The period after which the relationship is deleted when the aging mechanism is enabled.
<b>Allow CI Update</b>	When the value is set to true, the DFM process automatically updates the relationship.
<b>Created By</b>	The user name of the administrator who manually created the relationship, where applicable.
<b>Create Time</b>	The date and time when the relationship was created.
<b>Deletion Candidate Period</b>	The number of days after which the relationship becomes a candidate for deletion.
<b>Description</b>	A detailed description of the relationship.
<b>Destination Network</b>	Defined only for route links. Indicates the destination network address to which this route is configured.

UI Element (A-Z)	Description
<b>Address</b>	
<b>Enable Aging</b>	<p>If a CI or relationship is not updated or refreshed over a period of time (for example, a CI is not rediscovered by DFM and no manual update occurs), an aging mechanism deletes the CI from the CMDB. For details, see "CI Lifecycle and the Aging Mechanism" in the <i>HP Universal CMDB Administration Guide</i>.</p> <p><b>True:</b> the aging mechanism is enabled for this CI or relationship.</p> <p><b>Default value: false.</b> The default value for DFM CIs is <b>true</b>.</p> <div data-bbox="402 695 1370 898" style="background-color: #f0f0f0; padding: 10px;"> <p><b>Note:</b></p> <ul style="list-style-type: none"> <li>• If the aging mechanism is disabled, this field is ignored.</li> <li>• This field is only displayed for certain CIs.</li> </ul> </div>
<b>Last Access Time</b>	<p>The time that the relationship was last accessed, whether when being updated or being discovered by DFM. This field is only displayed for certain CIs.</p> <p>This parameter is used by the aging mechanism. For details, see "CI Lifecycle and the Aging Mechanism" in the <i>HP Universal CMDB Administration Guide</i>.</p>
<b>Last Modified Time</b>	The date and time when the relationship properties were last updated.
<b>Must</b>	<p>When the value is set to true, the child CI is dominant when the percentage rule is used to calculate status for the parent CI. If the CI has low status, the parent must take the child CI status, if necessary overriding the percentage rule calculation. This is useful to give emphasis to an important CI. For example, you might want to define <b>Must</b> for a database CI, so that status is <b>critical</b> all the way up the subtree if the database falls, regardless of the status of the other CIs in the subtree.</p> <p>The must status defined for a relationship applies for that relationship only – it is not used in any other relationships of the child CI. This field is only relevant when working with HP Business Service Management.</p>
<b>Name</b>	A brief description of the relationship. If no value is entered, the relationship type is used in place of the name.
<b>Note</b>	Enables you to enter other information about the relationship.
<b>Origin</b>	An ID for the source that automatically created the relationship, or the application

UI Element (A-Z)	Description
	where the relationship was created.
<b>Updated By</b>	The user name of the administrator who updated the CI properties.
<b>User Label</b>	Enables you to define a display label for the relationship. If no value is entered, the relationship name appears as the default label.
<b>Weight</b>	<p>When a weight value is entered, the child CI is given more weight in percentage calculations, when percentage rule is used to calculate status for the parent CI. For example, if a child CI is given a weight of 3, then it has three times more impact on the parent status calculation than its unweighted siblings.</p> <p>The weight defined for a relationship applies for that relationship only – it is not used in any other relationships the child CI may have. This field is only relevant when working with HP Business Service Management.</p>

## IT Universe Manager Page

This page enables you to define and manage the CIs and relationships in your views.

<b>To access</b>	Select <b>IT Universe Manager</b> from the Navigation Menu or select <b>Managers &gt; Modeling &gt; IT Universe Manager</b> .
<b>Important information</b>	<p>The IT Universe Manager page contains the following panes:</p> <ul style="list-style-type: none"> <li>• <b>CI Selector.</b> Displays the CIs of a selected view. You can select the view from a drop-down list or search for a specific CI. For details, see "<a href="#">CI Selector</a>" on page 135.</li> <li>• <b>Topology Map.</b> Displays the CIs of a selected view in Map mode or Text mode.</li> <li>• <b>Advanced Pane.</b> Displays properties, history, and discovery for the selected CI or view.</li> <li>• <b>Get Related CIs.</b> This pane can be accessed from the Related CIs tab of the Topology Map. It controls the content of the display in the tab.</li> </ul> <p>In IT Universe Manager, you can create new CIs, modify existing CIs, or delete CIs. All of these actions have a direct effect on the entire IT Universe model. For example, if you delete a CI in your view, that CI is deleted from the IT Universe model and no longer appears in any view.</p>
<b>Relevant tasks</b>	<ul style="list-style-type: none"> <li>• "<a href="#">How to Create CIs and Relationships</a>" on page 194</li> </ul>



	<ul style="list-style-type: none"> <li>• <a href="#">"How to Print and Save a Topology Map to File"</a> on page 213</li> <li>• <a href="#">"How to Check the Status of Application Discovery (Rediscover a View)"</a> on page 196</li> <li>• <a href="#">"How to Retrieve Impact Analysis Results – Scenario"</a> on page 207</li> <li>• <a href="#">"How to Take a Snapshot of a View"</a> on page 213</li> <li>• <a href="#">"How to View Related CIs"</a> on page 194</li> </ul>
<b>See also</b>	<ul style="list-style-type: none"> <li>• <a href="#">"IT Universe Manager Overview"</a> on page 181</li> <li>• <a href="#">"Working with Views in IT Universe Manager"</a> on page 182</li> <li>• <a href="#">"CI Selector"</a> on page 135</li> <li>• <a href="#">"Topology Map Overview"</a> on page 148</li> <li>• <a href="#">"IT Universe Manager User Interface"</a> on page 213</li> </ul>

## Topology Map

This area displays the CIs of the currently selected view in graphical or table format. By default, the CIs are displayed in graphical format.

<b>To access</b>	Select <b>Managers &gt; Modeling &gt; IT Universe Manager</b> .
<b>Important information</b>	<p>You can customize the Topology Map shortcut menu to include other commands (for example, ping, run a program, open a URL) from within CI Type Manager. For details, see <a href="#">"Create Configuration Item Type/Relationship/Calculated Relationship Wizard"</a> on page 506.</p> <div style="background-color: #f0f0f0; padding: 10px; border: 1px solid #ccc;"> <p><b>Note:</b> For grouped CIs and the relationships between them, not all of the shortcut menu options are active. Grouped CIs appear in parentheses in the CI Selector and in the Topology Map. You can double-click a link to a grouped CI to open the Link Map, which displays the individual CIs and relationships. Right-click a CI or relationship in the Link Map to display the regular shortcut menu. For details about grouping CIs, see <a href="#">"Query Node Grouping Dialog Box"</a> on page 334.</p> </div>
<b>See also</b>	<a href="#">"Working with the Topology Map"</a> on page 148

User interface elements are described below (unlabeled elements are shown in angle brackets>):

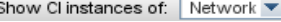
UI Element (A-Z)	Description
 <b>Map mode</b>	<p><b>Map.</b> Displays the selected layer of CIs in topology map format.</p> <p><b>Note:</b> If the selected layer of the view is too large to display in topology map format, a message appears with a link to display the layer in text format.</p>
 <b>Text mode</b>	<p><b>Text.</b> Displays the attribute properties of the CIs in the selected layer in table format.</p> <p>For details on some of the toolbar icons in Text Mode, see "<a href="#">CI Instances Dialog Box</a>" on page 66.</p>
	<p>Specify the CIT you want displayed in the table. The table also includes the children of the selected CIT.</p> <p><b>Note:</b> This option is displayed in Text mode only.</p>
<p><b>&lt;Breadcrumbs&gt;</b></p>	<p>At the top of the topology map, the breadcrumbs indicate the relevant query nodes in each layer of the view for the path to the selected layer. The first item in the path is the <b>Top Layer</b>. When you select a CI from the layer below, the parent CI forms the next item in the breadcrumb path. You can click on any item in the path to display that layer in the topology map.</p>
<p><b>&lt;CI type attributes&gt;</b></p>	<p>The columns appearing in Text mode represent the CIT attributes of the selected CIs.</p>
<p><b>&lt;Group by&gt;</b></p>	<p>The CIs in the topology map are displayed according to the default grouping selected in the view definition. When consuming the view in IT Universe Manager, you can manually select a different grouping method. The available options are:</p> <ul style="list-style-type: none"> <li>• <b>Group by Layer.</b> Group the CIs according to the value of the <b>layer</b> attribute of their CI type.</li> <li>• <b>Group by CI Type.</b> Group the CIs according to their CI type.</li> <li>• <b>Group by Classification.</b> Group the CIs according to the value of the <b>classification</b> attribute of their CI type.</li> <li>• <b>No Grouping.</b> Do not group CIs.</li> </ul>



UI Element (A-Z)	Description
	<p><b>Note:</b></p> <ul style="list-style-type: none"> <li>• This option is available in Map mode only.</li> <li>• When a grouping option is selected, each group contains an indicator displaying the number of CIs in the group. If a group contains a large number of CIs, it opens in collapsed format, displaying only the name and count indicator. Click the + sign button to expand the group and display all the CIs. You can set the threshold of CIs for automatically collapsing the group by modifying the <b>Initially expand group max CIs threshold</b> setting in the Infrastructure Settings Manager.</li> </ul>
<p><b>&lt;IT Universe Status Bar&gt;</b></p>	<p>The status bar below the topology map indicates the status of the following processes:</p> <ul style="list-style-type: none"> <li>• if Impact Analysis is active or not</li> <li>• if Change Timeframe is active or not</li> <li>• if Candidates for Deletion are shown or not</li> <li>• the time of the last update of the data</li> </ul>
<p><b>&lt;Legend&gt;</b></p>	<p>Indicates the icons displayed next to CIs with any of the following special statuses:</p> <ul style="list-style-type: none"> <li>• <b>Added.</b> When Change Timeframe is active, indicates that the CI was added.</li> <li>• <b>Candidate for Deletion.</b> Indicates that the CI is a candidate for deletion.</li> <li>• <b>Changed.</b> When Change Timeframe is active, indicates that the CI was changed.</li> <li>• <b>Drill Down One Layer.</b> Indicates that there are CIs under the CI on a lower layer.</li> <li>• <b>External.</b> Indicates that the CI is a federated CI.</li> <li>• <b>Impacted.</b> When Impact Analysis is active, indicates an impacted CI.</li> </ul>

UI Element (A-Z)	Description
	<ul style="list-style-type: none"> <li>• <b>Impacted and Trigger.</b> When Impact Analysis is active, indicates a trigger CI that is impacted.</li> <li>• <b>Note.</b> Indicates that a note was added for the CI.</li> <li>• <b>Trigger.</b> When Impact Analysis is active, indicates a trigger CI.</li> </ul>
<Main Menu>	For details, see <a href="#">"Main Menu" on page 164.</a>
<Query Node>	<p>The query nodes in the topology map represent CIs.</p> <p>Hold the pointer over a query node to display its tooltip which describes the type of the CI.</p>
<Relationship>	<p>The links in the topology map represent relationships.</p> <p>Hold the pointer over a relationship to display its tooltip, which describes the type of the relationship.</p> <div data-bbox="591 915 1370 1052" style="background-color: #f0f0f0; padding: 5px;"> <p><b>Note:</b> When you select a calculated relationship, the <b>Delete</b>  button on the toolbar is disabled.</p> </div>
<Toolbar>	<p>For details, see <a href="#">"Toolbar Options" on page 168.</a></p> <div data-bbox="591 1136 1370 1293" style="background-color: #f0f0f0; padding: 5px;"> <p><b>Note:</b> When accessing the Topology map via direct links, the toolbar includes options from the Related CIs Map. For details, see <a href="#">"Get Related CIs From CMDB Dialog Box" on page 226.</a></p> </div>
<Tooltip>	<p>Hold the pointer over a CI to display a tooltip which shows CI data. The tooltip displays all attributes for the CI which are marked with one of the following qualifiers:</p> <ul style="list-style-type: none"> <li>• Comparable</li> <li>• Asset Data</li> <li>• Managed</li> </ul> <p>When you hold the pointer over a count indicator, the tooltip displays the breakdown of the CIs under it by CI type. When a grouping option is selected, hold the pointer over the group to display a tooltip showing the breakdown of CIs in the group by CI type.</p>

UI Element (A-Z)	Description
<Topology Map Sidebar>	For details, see <a href="#">"Topology Map Sidebar" on page 176</a> .
Related CIs	Click the <b>Related CIs</b> tab to display the interdependencies of the selected CI within the view or the entire CMDB. You can control the scope of the display from the Get Related CIs pane.
View Results	Click the <b>View Results</b> tab to display an entire layer within a view.

### IT Universe Manager Shortcut Menu

The IT Universe Manager page includes the following elements (listed alphabetically) available by right-clicking a CI or relationship in the CI Selector pane or the Topology Map:

Menu Item	Description
Actions	<p>Select one of the following options:</p> <ul style="list-style-type: none"> <li>• <b>Add CI to Discovery Job.</b> Displays the Add CI to Discovery Job dialog box, which enables you to manually invoke a DFM job for the selected CI. You can use this option to discover additional information about the CI through one of the available DFM jobs.</li> <li>• <b>Remove CI from Discovery Job.</b> Displays the Remove CI from Discovery Job dialog box, which enables you to manually remove a CI from the DFM job.</li> <li>• <b>Show Discovery Progress.</b> Opens the Discovery Progress dialog box for the selected CI.</li> <li>• <b>Recently Discovered By.</b> Opens the Recently Discovered By dialog box for the selected CI.</li> <li>• <b>Check Network Availability.</b> Opens the Check Network Availability dialog box for the selected CI.</li> <li>• <b>Open CI Credentials.</b> Displays the <b>Protocol Parameter</b> dialog box, which enables you to view the details of a previously-defined credential for that CI. You cannot make any changes.</li> </ul> <p><b>Note:</b> This option is only relevant for CIs that include a credentials property.</p>

Menu Item	Description
	<p>For details, see Protocol Parameter Dialog Box in the <i>HP Universal CMDB Data Flow Management Guide</i>.</p> <ul style="list-style-type: none"> <li>• <b>Edit CI Credentials.</b> Displays the <b>Choose Credentials</b> dialog box, which enables you to choose another credentials set or edit the existing credentials.</li> </ul> <p><b>Note:</b> This option is only relevant for CIs that include a credentials property.</p> <p>For details, see the supported protocols in the <i>HP UCMDB Discovery and Integrations Content Guide</i>.</p> <ul style="list-style-type: none"> <li>• <b>Reprocess Scan File.</b> Reprocesses the scan files for the selected node.</li> </ul> <p><b>Note:</b> This option is only available for CIs of type <b>node</b> or its subtypes.</p>
<b>Add CIs to Model</b>	Adds selected CIs to a new or existing model.
<b>Add CIs to View</b>	Adds selected CIs to a new or existing perspective-based view.
<b>Assign Tenants</b>	<p>Open the Assign Tenants dialog box which enables you to assign tenants to the CI.</p> <p><b>Note:</b> This option is only available when multi-tenancy is enabled.</p>
<b>CI/Relationship History</b>	Displays the CI History dialog box. For details, see " <a href="#">CI/Relationship History Dialog Box</a> " on page 218.
<b>Compare CIs Report</b>	<p>Run a Compare CIs Report for the selected CI. For details, see "<a href="#">Compare CIs Report</a>" on page 390.</p> <p><b>Note:</b> This option is only active when one or two CIs are selected.</p>
<b>Delete from CMDB</b>	<p>Enables you to delete the selected CI or relationship from the view and from the CMDB.</p> <p><b>Note:</b> When you delete a parent CI, the selected CI and its children are removed from the view, but only the selected CI is removed from the database.</p>

Menu Item	Description
<b>Generate Sub Report</b>	Opens the Generate Sub Report dialog box, which enables you to select perspectives for the CI to create a Sub Report. For details, see <a href="#">"Generate Sub Report Dialog Box" on page 225</a> .
<b>Get Related CIs</b>	Opens the Get Related CIs from CMDB dialog box. For details, see <a href="#">"Get Related CIs From CMDB Dialog Box" on page 226</a> .
<b>Label</b>	<p>Select one of the following options:</p> <ul style="list-style-type: none"> <li>• <b>Edit Label.</b> Opens the Edit Label dialog box which enables you to edit the name of the CI.</li> <li>• <b>Restore Default Label.</b> Resets the CI name to its default value from the CMDB.</li> </ul>
<b>Merge CIs</b>	<p>Opens the Merge CIs dialog box enabling you to manually merge Running Software, Node, and Business Element CIs.</p> <p>In the Merge CIs dialog box, select one of the CIs to be the <b>main CI</b>. The other CIs, the <b>merging CIs</b>, are merged into the main CI. CIs are merged as follows:</p> <ul style="list-style-type: none"> <li>• Properties from the merging CIs that do not exist in the main CI are copied to the main CI.</li> <li>• Properties that exist in both the main and merging CIs are merged according to the defined reconciliation priority:                         <ul style="list-style-type: none"> <li>◦ If all the CIs have the same priority, then the main CI's property is retained.</li> <li>◦ If the CIs have different priorities, the property of the CI with the higher priority is used.</li> </ul> </li> </ul> <p>After the merge, the Global ID of the main CI remains, and the merging CIs are deleted.</p> <div style="background-color: #f0f0f0; padding: 10px; margin-top: 10px;"> <p><b>Note:</b></p> <ul style="list-style-type: none"> <li>• This option is only relevant when at least two CIs of type Running Software, Node, or Business Element are selected. CIs can only be merged if their CI types are on the same branch in the Class Model.</li> <li>• When you merge CIs, the topologies of the views that contain those CIs are updated.</li> </ul> </div> <p><b>Example:</b></p>

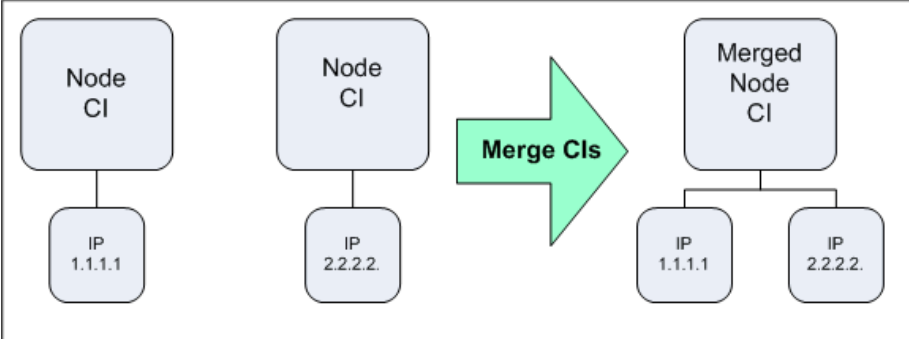
Menu Item	Description
	
<b>Note</b>	<p>Select one of the following options:</p> <ul style="list-style-type: none"> <li>• <b>Add Note.</b> Opens an editing box where you can add a note to the CI.</li> <li>• <b>Delete Note.</b> Deletes all text saved in a note for the selected CI.</li> </ul>
<b>Open UCMDB Browser</b>	<p>Opens the UCMDB Browser.</p> <p><b>Note:</b> This option is only available when a single CI is selected. It is not relevant for relationships.</p>
<b>Properties</b>	<p>Displays the Properties page for the selected CI or relationship. For details, see <a href="#">"Configuration Item Properties Dialog Box"</a> on page 220.</p>
<b>Relate to CI</b>	<p>Opens the Insert Relationship dialog box. For details, see <a href="#">"Insert Relationship Dialog Box"</a> on page 226.</p>
<b>Run Impact Analysis</b>	<p>Enables you to run the Impact rule you defined in the Impact Analysis Manager. Displays the Run Impact Analysis dialog box. For details, see <a href="#">"Impact Analysis Manager"</a> on page 466.</p> <p><b>Note:</b> You can only see Impact Analysis results if you defined an Impact rule for that view in Impact Analysis Manager.</p>
<b>Show Compound Path</b>	<p>Appears only for compound relationships. Displays the Link Map for the selected relationship, which shows the CIs involved in the compound relationship.</p>
<b>Show Impact</b>	<p>Enables you to select a CI that is defined by an Impact rule as a root cause CI, and to display all the CIs that are impacted by it, and their statuses, in a separate window.</p> <p>This option appears only after the following has occurred:</p>

Menu Item	Description
	<ul style="list-style-type: none"> <li>You defined an Impact rule for the selected view in Impact Analysis Manager (for details, see <a href="#">"Impact Analysis Manager" on page 466</a>).</li> <li>You clicked <b>Show in Views</b> in the Run Impact Analysis dialog box.</li> <li>Impact Analysis results appear in the Topology Map.</li> </ul> <p>For example, suppose an Impact rule is defined (for an <b>IP Address</b> CI) that specifies that the rule impacts nodes, ports, and client-servers linked to the IP Address.</p> <p>By using the <b>Show Impact</b> option, you can display all CIs that are impacted by the <b>IP Address</b> CI.</p>
<b>Show Root Cause</b>	<p>This option enables you to retrieve root cause information for CIs that are impacted by a chain of Impact rules. The output of Show Root Cause displays a logical map that describes a chain of trigger/impacted CITs that impact the CI.</p> <p>The root cause CI is displayed in a separate window. If only one Impact rule is defined for this CI, the Impact Analysis window is directly displayed.</p> <p>This option appears only after the following has occurred:</p> <ul style="list-style-type: none"> <li>You defined an Impact rule for the selected view in the Impact Analysis Manager (for details, see <a href="#">"Impact Analysis Manager" on page 466</a>).</li> <li>You clicked <b>Show in Views</b> in the Run Impact Analysis dialog box.</li> <li>Impact Analysis results appear in the Topology Map.</li> </ul> <p>A window is displayed containing the root cause CI and all the other CITs in the Impact rule chain.</p> <p>To view the information about specific CIs that are triggered or impacted by the Impact rule, double-click the relationship connecting the CIs. A map is displayed.</p>

### Advanced Pane

User interface elements are described below:

UI Element (A-Z)	Description
<b>Discovery</b>	Displays the discovery progress for the selected CIs. For details, see Discovery Progress

UI Element (A-Z)	Description
<b>tab</b>	Dialog Box in the <i>HP Universal CMDB Data Flow Management Guide</i> .
<b>History tab</b>	Displays the history for the selected CI. For details, see " <a href="#">CI/Relationship History Dialog Box</a> " on page 218.
<b>Properties tab</b>	Displays the selected CI's properties (the same properties that appear in the Configuration Item Properties dialog box). You can view the properties in the properties tab, but you must open the dialog box to edit the properties. For details, see " <a href="#">Configuration Item Properties Dialog Box</a> " on page 220.





### Get Related CIs Pane

This pane enables you to control the different options for viewing related CIs for a selected CI.

<b>To access</b>	Appears in the Related CIs tab of IT Universe Manager. If it is hidden, click the <b>Show Get Related CIs pane</b>  button on the toolbar to display it.
<b>Important information</b>	<p>You can control the display in the Related CIs tab with the following controls:</p> <ul style="list-style-type: none"> <li>• Set the scope of the display</li> <li>• Filter the related CIs by CI type</li> <li>• Apply perspectives to the selected CI</li> </ul> <p>It is possible to display related CIs for several CIs at the same time. Hold down the <b>CTRL</b> key to select multiple CIs at the same time in the CI Selector or the topology map.</p> <div style="background-color: #f0f0f0; padding: 10px; border: 1px solid #ccc;"> <p><b>Note:</b> You can select to run the Get Related CIs search over integrated CIs also. If the search results include CIs from a federated data source, they appear in the topology map with an arrow icon, indicating that they are federated CIs. However, you cannot display related CIs of a federated CI.</p> </div>
<b>Relevant tasks</b>	<a href="#">"How to View Related CIs" on page 194</a>



User interface elements are described below:



UI Element (A-Z)	Description
	<b>Back.</b> Displays the previous search results.
	<b>Forward.</b> Display the next search results.
	<b>Clear Current Display.</b> When the button is selected, the related CIs are added to the current results. When it is not selected, the current display content is cleared and only the new related CIs are displayed.
	<b>Display search results with/without grouping.</b> When the button is selected, the related CIs are displayed with the hierarchical grouping of the applied perspective. When it is not selected, the related CIs are displayed without any grouping.
	<p><b>Select Target Integration Points.</b> Enables you to include integrated CIs in your search results. Select the required integration points from the pop-up dialog box.</p> <p><b>Note:</b> If you select a disconnected integration point for your search, an error message appears when the search is run, asking if you want to see local search results.</p>
<b>Apply perspectives to CI</b>	<p>Select perspectives from the list to apply to the selected CI. Only perspectives relevant to the selected CI appear in the list. The selected CI is used as content for the selected perspectives and the view results are displayed.</p> <p><b>Note:</b> Application of perspectives is only relevant when <b>CMDB</b> is selected as the scope. The feature is inactive when <b>View</b> is selected as the scope.</p>
<b>Filter Related CIs by CI Type</b>	<p>Select the CI types from the list to display in the related CI results. Only the selected CI types appear in the displayed results.</p>
<b>Select scope</b>	<p>Select the scope of the related CIs displayed:</p> <ul style="list-style-type: none"> <li>• <b>View.</b> All related CIs in the selected view.</li> <li>• <b>CMDB.</b> All related CIs in the CMDB.</li> </ul> <p><b>Note:</b> This feature is not available in the Get Related CIs from CMDB dialog box opened from the shortcut menu.</p>
<b>Show Related CIs</b>	<p>Click to display the related CIs according to your selection.</p>

## New CI/New Related CI Dialog Box

This dialog box enables you to define a new CI or a new related CI.

<b>To access</b>	In IT Universe Manager, click the <b>New CI</b>  button on the toolbar to create a non-related CI. Select a CI in the topology map and click the <b>New Related CI</b>  button to create a related CI.
<b>Important information</b>	<p>To define a new CI, select the CI type from the tree at the top of the dialog box. The CI types in the tree that are available to be instantiated appear in black. The CI types in faded text cannot be instantiated.</p> <p>Edit the properties in the Define new CI properties area. The table below includes the properties which are common to all CIs. In addition, there are other properties specific to each CI.</p> <p>If you are creating a related CI, click <b>Relationship</b> to go to the relationship mode of the dialog box. Select a relationship and edit its properties.</p>
<b>Relevant tasks</b>	<a href="#">"How to Create CIs and Relationships" on page 194</a>
<b>See also</b>	<ul style="list-style-type: none"> <li>• <a href="#">"CI Selector" on page 135</a></li> <li>• <a href="#">"Relationship Dialog Box" on page 244</a></li> <li>• "CI Lifecycle and the Aging Mechanism" in the <i>HP Universal CMDB Administration Guide</i></li> </ul>

User interface elements are described below:

<b>UI Element (A-Z)</b>	<b>Description</b>
<b>Actual Deletion Period</b>	The period after which the CI is deleted when the aging mechanism is enabled.
<b>Allow CI Update</b>	<p>When the value is set to true, this option enables the DFM process to automatically update the CI properties with information that it discovers. If you change the value of a property supplied by the DFM process, the value is overridden by the discovered value.</p> <p>When the value is set to false, the CI properties are not overridden by the DFM process.</p>

UI Element (A-Z)	Description
<b>Created By</b>	The user name of the administrator who manually created the CI, where applicable.
<b>Create Time</b>	The date and time when the CI was created.
<b>Deletion Candidate Period</b>	The period after which the CI becomes a candidate for deletion when the aging mechanism is enabled.
<b>Description</b>	A description of the CI.
<b>Display Label</b>	The label that appears for the CI in the topology map.
<b>Enable Aging</b>	<p>If a CI or relationship is not updated or refreshed over a period of time (for example, a CI is not rediscovered by DFM and no manual update occurs), an aging mechanism deletes the CI from the CMDB. For details, see "The Aging Mechanism Overview" in the <i>HP Universal CMDB Administration Guide</i>.</p> <p><b>True:</b> the aging mechanism is enabled for this CI.</p> <p><b>False:</b> the aging mechanism is disabled for this CI.</p> <p>The default value is determined by the default value of the <b>Enable Aging</b> attribute of the CI type.</p> <div data-bbox="412 1136 1369 1524" style="background-color: #f0f0f0; padding: 10px;"> <p><b>Note:</b></p> <ul style="list-style-type: none"> <li>• If the aging mechanism is disabled in Aging Status, this field is ignored.</li> <li>• This field is displayed for certain CIs only.</li> <li>• You can change the default value for all new CIs of this type by editing the default value of the <b>Enable Aging</b> attribute for this CI type. For details, see "How to Enable and Run the Aging Mechanism" in the <i>HP Universal CMDB Administration Guide</i>.</li> </ul> </div>
<b>Is Candidate For Deletion</b>	Indicates if the CI is a candidate for deletion.
<b>Last Access Time</b>	<p>The time that the CI was last accessed, whether when being updated or being discovered by DFM. This field is displayed only for certain CIs.</p> <p>This parameter is used by the aging mechanism. For details, see "CI Lifecycle and the Aging Mechanism" in the <i>HP Universal CMDB Administration Guide</i>.</p>
<b>Last</b>	The date and time when the CI properties were last updated.

UI Element (A-Z)	Description
<b>Modified Time</b>	
<b>Name</b>	The name of the CI.
<b>Note</b>	Enables you to enter other information about the CI.
<b>Origin</b>	An ID for the source that automatically created the CI, or the application where the CI was created.
<b>Relationship</b>	For a related CI, click <b>Relationship</b> to go to the relationship mode of the dialog box.
<b>Select CI Type</b>	Enables you to select the CI type from the tree for the new CI. The CI types that are available for the selected CI or view appear active in the CI type tree. The other CI types appear in faded text and cannot be selected.  To limit the CI type tree to CI types from the current view, select <b>CI Types from the current view</b> on the right. To display all CI types in the tree, select <b>All CI Types</b> .
<b>Updated By</b>	The user name of the administrator who updated the CI properties.
<b>User Label</b>	Enables you to define a display label for the CI. If no value is entered, the CI name appears as the default label.

## Relationship Dialog Box

This page enables you to define the relationship between the new CI and the CI selected in the view, as well as the properties of the relationship.

<b>To access</b>	Click <b>Relationship</b> from the New Related CI dialog box.
<b>Important information</b>	This page only appears for new related CIs.

User interface elements are described below:

UI Element (A-Z)	Description
<b>Allow CI Update</b>	When the value is set to true, the DFM process automatically updates the relationship.
<b>CI Definition</b>	<b>CI Definition.</b> Returns to the CI properties mode of the dialog box.
<b>Created By</b>	The user name of the administrator who manually created the relationship, where

UI Element (A-Z)	Description
	applicable.
<b>Create Time</b>	The date and time when the relationship was created.
<b>Description</b>	A description of the relationship.
<b>Direction</b>	Select the relationship direction from the drop-down box.
<b>Enable Aging</b>	<p>If a CI or relationship is not updated or refreshed over a period of time (for example, a CI is not rediscovered by DFM and no manual update occurs), an aging mechanism deletes the CI from the CMDB. For details, see <i>The Aging Mechanism Overview</i> in the <i>HP Universal CMDB Administration Guide</i>.</p> <p><b>True:</b> the aging mechanism is enabled for this relationship.</p> <p><b>False:</b> the aging mechanism is disabled for this relationship.</p> <p>The default value is determined by the default value of the <b>Enable Aging</b> attribute of the CI type.</p> <div style="background-color: #f0f0f0; padding: 10px; margin-top: 10px;"> <p><b>Note:</b></p> <ul style="list-style-type: none"> <li>• If the aging mechanism is disabled in Aging Status, this field is ignored.</li> <li>• This field is displayed for certain relationships only.</li> <li>• You can change the default value for all new relationships of this type by editing the default value of the <b>Enable Aging</b> attribute for this relationship type. For details, see <i>How to Enable and Run the Aging Mechanism</i> in the <i>HP Universal CMDB Administration Guide</i>.</li> </ul> </div>
<b>Last Access Time</b>	<p>The time that the relationship was last accessed, whether when being updated or being discovered by DFM. This field is only displayed for certain relationships.</p> <p>This parameter is used by the aging mechanism. For details, see <i>CI Lifecycle</i> and the <i>Aging Mechanism</i> in the <i>HP Universal CMDB Administration Guide</i>.</p>
<b>Must</b>	<p>When the value is set to true, the child CI is dominant when the percentage rule is used to calculate status for the parent CI. If the CI has low status, the parent must take the child CI status, overriding the percentage rule calculation if necessary. This is useful to give emphasis to an important CI. For example, you might want to define <b>Must</b> for a database CI, so that status is critical all the way up the subtree if the database falls, regardless of the status of the other CIs in the subtree.</p> <p>The Must status defined for a relationship applies to that relationship only – it is not</p>

UI Element (A-Z)	Description
	used in any other relationships of the child CI. This field is only relevant when working with HP Business Service Management.
<b>Name</b>	The name of the CI.
<b>Network Address</b>	Defined only for route links. Indicates the destination network address to which this route is configured.
<b>Note</b>	Enables you to enter other information about the CI.
<b>Origin</b>	An ID for the source that automatically created the relationship, or the application where the relationship was created.
<b>Relationship</b>	<p>Enables you to define the type of relationship that is created between the two CIs.</p> <div style="background-color: #f0f0f0; padding: 5px; border: 1px solid #ccc;"> <p><b>Note:</b> If you receive an error message about a lack of reconciliation data when you create a CI, use either a Composition or Containment relationship. You can change the relationship to a different type after you create the CI.</p> </div>
<b>Source CI</b>	The name of the CI on the first side of the relationship. This is the CI that you selected in the view.
<b>Target CI</b>	The name of the CI on the second side of the relationship. This is the new CI that you are creating.
<b>Updated By</b>	The user name of the administrator who updated the relationship properties.
<b>Update Time</b>	The date and time when the CI properties were last updated.
<b>User Label</b>	Enables you to define a display label for the relationship.
<b>Weight</b>	<p>When a weight value is entered, the child CI is given more weight in percentage calculations, when the percentage rule is used to calculate status for the parent CI. For example, if a child CI is given a weight of 3, then it has three times more impact on the parent status calculation than its unweighted siblings.</p> <p>The weight defined for a relationship applies to that relationship only – it is not used in any other relationships of the child CI. This field is only relevant when working with HP Business Service Management.</p>

## Recently Discovered By Dialog Box

This dialog box displays the discovery jobs that discovered the selected CI within the specified time period.

<b>To access</b>	In IT Universe Manager, right-click a CI and select <b>Actions &gt; Recently Discovered By</b> from the shortcut menu.
------------------	--

User interface elements are described below:

UI Element (A-Z)	Description
	<b>Refresh.</b> Refreshes the data.
<b>Discovered On</b>	The date the CI was discovered by the discovery job.
<b>From Date</b>	Select the time period to check for jobs that discovered the selected CI. You can select <b>Custom</b> and a specific date to search all discovery jobs from that date until now.
<b>Job Name</b>	The name of the job that discovered the selected CI.
<b>Probe</b>	The probe on which the CI was discovered.
<b>Trigger CI</b>	The trigger CI for the discovery job.

## Run Impact Analysis Dialog Box

This dialog box enables you to run the Impact rule you defined in Impact Analysis Manager for that view.



<b>To access</b>	Select <b>Managers &gt; Modeling &gt; IT Universe Manager</b> . Right-click a trigger query node in the Topology Map and select <b>Run Impact Analysis</b> or click the <b>Run Impact Analysis Now</b>  button on the IT Universe status bar.
<b>Important information</b>	You can: <ul style="list-style-type: none"> <li>• Display in a new window all the CIs that are impacted by the trigger CI. The relationships in the map represent the Impact rules. The name of the relationship is the name of the Impact rule you defined in the Impact Analysis Manager. For details, see <a href="#">"Show Map" on page 249</a>.</li> <li>• Simulate how the statuses of the impacted CIs are impacted. For details, see <a href="#">"Show in Views" on the next page</a>.</li> </ul>

	<ul style="list-style-type: none"> <li>• Generate a report that displays a list of CIs that are impacted in the system as a result of the simulated changes. For details, see <a href="#">"Generate Report" below</a>.</li> </ul> <div style="background-color: #f0f0f0; padding: 5px; margin-top: 10px;"> <p><b>Note:</b> This dialog only appears if an Impact rule is defined for that view. For details, see <a href="#">"Impact Analysis Manager" on page 466</a>.</p> </div>
<b>Relevant tasks</b>	<a href="#">"How to Retrieve Impact Analysis Results – Scenario" on page 207</a>
<b>See also</b>	<ul style="list-style-type: none"> <li>• <a href="#">"IT Universe Manager Overview" on page 181</a></li> <li>• <a href="#">"Impact Analysis Manager Overview" on page 466</a></li> <li>• <a href="#">"IT Universe Manager User Interface" on page 213</a></li> </ul>

User interface elements are described below:

UI Element (A-Z)	Description
<b>All Impact rules</b>	Select to execute all impact rules in the system in the impact analysis.
<b>Generate Report</b>	<p>Generates an Impact Analysis report, which displays information that is divided as follows:</p> <ul style="list-style-type: none"> <li>• <b>Grouping by CIT.</b> All the impacted CIs (the CIs that are impacted in the system as a result of the simulated changes), sorted by CIT.</li> <li>• <b>Affected Application.</b> All the impacted CIs that belong to a specific business service.</li> <li>• <b>Triggered CIs.</b> The CIs that represent the changes you want to make to the system.</li> </ul> <p>For details on the Impact Analysis report, see <a href="#">"Impact Analysis Report" on page 415</a>.</p>
<b>Impact rules bundle</b>	Select the bundle containing the required impact rules for the impact analysis.
<b>Only Impact rules located in specified bundle</b>	Select to execute the impact rules from the specified bundle in the impact analysis.
<b>Show in Views</b>	Simulates how the statuses of the impacted CIs are impacted for the selected state. The Topology Map displays the statuses of the trigger CIs as well as all statuses of the CIs that are impacted by it.



UI Element (A-Z)	Description
	<p>The Topology Map also displays the Impact Analysis indicators:</p> <ul style="list-style-type: none"> <li>• A trigger CI is marked by this indicator: .</li> <li>• A CI that is both an impacted and a trigger CI is marked by this indicator: .</li> <li>• An impacted CI is marked by this indicator: .</li> </ul> <p><b>Note:</b> The statuses that appear here and the colors that represent each status are defined in the severity list for that state in the System Type Manager. For details, see <a href="#">"Create/Update List/Enumeration Definition Dialog Box" on page 522.</a></p>
<b>Show Map</b>	<p>Enables you to select an Impact rule, and then display in a new window, a simulation of all the CIs that are impacted by the trigger CI for the selected state. If only one Impact rule is defined for this CI, the Impact Rules window is displayed directly. For more details, see <a href="#">"Show Impact Pane" on page 251.</a></p> <p>The relationships in the map represent the Impact rules and the name of the relationship is the name of the Impact rule you defined in the Impact Analysis Manager.</p> <p><b>Note: Show Map</b> enables you to view the results of multiple triggers.</p>
<b>Trigger Severity</b>	<p>Select the required severity on the scale.</p> <p><b>Note:</b> The severity scale was defined for the state in the System Type Manager. For details, see <a href="#">"System Type Manager" on page 489.</a></p> <p>For example, you can create an Impact rule in the Impact Analysis Manager that defines the severity of the trigger query node as other than <b>Warning (1)</b>. If you select a severity other than <b>Warning (1)</b>, for example, <b>Minor (3)</b>, the condition is met and the simulated changes in the system are triggered.</p> <p>For details, see the <a href="#">"Impact Rules Definition Dialog Box" on page 479.</a></p>

## Save Snapshot Dialog Box

This dialog box enables you to take a snapshot of a view and save it.

<b>To access</b>	In IT Universe Manager, click the <b>Snapshot</b>  button in the CI Selector and select <b>Save Snapshot</b> .
<b>Important information</b>	You can compare snapshots of the same view taken at different times using the Compare Snapshots Report. For details, see " <a href="#">Compare Snapshots Report</a> " on page 395.
<b>Relevant tasks</b>	<ul style="list-style-type: none"> <li>• "<a href="#">How to Take a Snapshot of a View</a>" on page 213</li> <li>• "<a href="#">How to Compare Snapshots</a>" on page 360</li> </ul>
<b>See also</b>	<ul style="list-style-type: none"> <li>• "<a href="#">IT Universe Manager Overview</a>" on page 181</li> <li>• "<a href="#">IT Universe Manager User Interface</a>" on page 213</li> </ul>

User interface elements are described below:

UI Element (A-Z)	Description
<b>Description</b>	A description of the snapshot (optional).
<b>Note</b>	A note about the snapshot (optional).
<b>View Name</b>	The name of the view as it appears in the CI Selector. This field cannot be edited.



## Show Discovery Status and Changes Dialog Box

This dialog box enables you to find recent changes, for example, to an application, by rediscovering the CIs and jobs in a view.

<b>To access</b>	<p>In IT Universe Manager:</p> <ul style="list-style-type: none"> <li>• To rediscover all CIs of a view, click the <b>Show Discovery and Changes Summary</b>  button on the toolbar of the <b>Browse Views</b> tab in the CI Selector. The <b>Show Discovery Status and Changes</b> dialog box is displayed.</li> <li>• To rediscover one CI or several CIs in a view, select the CI and display the Discovery tab in the Advanced pane.</li> </ul>
<b>Important information</b>	<p>By default, you can run the rediscovery procedure on views that include less than 10,000 CIs.</p> <p>To increase the number of CIs that you can rediscover in a view:</p> <ol style="list-style-type: none"> <li>1. Access the Infrastructure Settings Manager (<b>Administration &gt; Infrastructure Settings Manager</b>).</li> </ol>

	<ol style="list-style-type: none"> <li>2. Select the <b>Max CIs in view supported to rediscover</b> setting in the infrastructure settings table.</li> <li>3. Click the <b>Value</b> column and change the number.</li> <li>4. Restart the server for the change to take effect.</li> </ol> <p>For details on working with the Infrastructure Settings Manager, see "Infrastructure Settings Manager" in the <i>HP Universal CMDB Administration Guide</i>.</p>
<b>Relevant tasks</b>	<p><a href="#">"How to Check the Status of Application Discovery (Rediscover a View)" on page 196</a></p>
<b>See also</b>	<ul style="list-style-type: none"> <li>• "Discovery Control Panel - Details Tab" in the <i>HP Universal CMDB Data Flow Management Guide</i></li> <li>• <a href="#">"IT Universe Manager User Interface" on page 213</a></li> </ul>

User interface elements are described below:

UI Element (A-Z)	Description
	<p><b>Refresh.</b> Refreshes the status of the selected CIs.</p> <p>This button is disabled when there is no data to be reloaded.</p>
	<p><b>Rerun Discovery.</b> Reruns the discovery.</p>
<b>Discovery Progress Status on View</b>	<p>For details, see "Discovery Control Panel - Details Tab" in the <i>HP Universal CMDB Data Flow Management Guide</i>.</p>
<b>History Changes on View</b>	<p>For details, see <a href="#">"CI/Relationship History Dialog Box" on page 218</a>.</p>

## Show Impact Pane

This page opens a window that displays the statuses of the trigger CI as well as all statuses of the CIs that are impacted by it.

<b>To access</b>	<p>In the Run Impact Analysis Dialog box, click <b>Show Map</b>.</p> <p>If Impact Analysis is already active, click the <b>Impact Analysis Is Active</b> link on the IT Universe status bar.</p>
<b>Important information</b>	<p>The following tabs are available:</p> <ul style="list-style-type: none"> <li>• <b>Impact Results.</b> Displays a map of all CIs impacted by the selected CI.</li> </ul>

	<ul style="list-style-type: none"> <li>• <b>Trigger CIs.</b> Displays a table of information on the selected trigger CIs.</li> </ul> <p>You can only see Impact Analysis results if you defined an Impact rule for that view in Impact Analysis Manager. For details, see <a href="#">"Impact Analysis Manager" on page 466</a>.</p> <p>To view information about specific CIs that are triggered or impacted by the Impact rule, double-click the relationship connecting the CIs. A map is displayed.</p> <p>The relationships in the map represent the Impact rules. The name of the relationship is the name of the Impact rule you defined in the Impact Analysis Manager.</p>
<b>Relevant tasks</b>	<a href="#">"How to Retrieve Impact Analysis Results – Scenario" on page 207</a>
<b>See also</b>	<ul style="list-style-type: none"> <li>• <a href="#">"IT Universe Manager Overview" on page 181</a></li> <li>• <a href="#">"Impact Analysis Manager Overview" on page 466</a></li> <li>• <a href="#">"IT Universe Manager User Interface" on page 213</a></li> </ul>

User interface elements are described below (unlabeled elements are shown in angle brackets):

UI Element (A-Z)	Description
<b>&lt;Legend&gt;</b>	<p>Indicates the icons displayed next to CIs with any of the following special statuses:</p> <ul style="list-style-type: none"> <li>• <b>Added.</b> When Change Timeframe is active, indicates that the CI was added.</li> <li>• <b>Candidate for Deletion.</b> Indicates that the CI is a candidate for deletion.</li> <li>• <b>Changed.</b> When Change Timeframe is active, indicates that the CI was changed.</li> <li>• <b>Drill Down One Layer.</b> Indicates that there are CIs under the CI on a lower layer.</li> <li>• <b>External.</b> Indicates that the CI is a federated CI.</li> <li>• <b>Impacted.</b> When Impact Analysis is active, indicates an impacted CI.</li> <li>• <b>Impacted and Trigger.</b> When Impact Analysis is active, indicates a trigger CI that is impacted.</li> <li>• <b>Note.</b> Indicates that a note was added for the CI.</li> <li>• <b>Trigger.</b> When Impact Analysis is active, indicates a trigger CI.</li> </ul>

UI Element (A-Z)	Description
<Relationship>	The relationships represent the Impact rule you defined in the Impact Analysis Manager. For details, see <a href="#">"Impact Rules Definition Dialog Box" on page 479</a> .
<The statuses and the colors that represent each one>	The statuses that appear and the colors that represent each status are the ones that are defined in the severity list for that state in the System Type Manager. For details, see <a href="#">"Create/Update List/Enumeration Definition Dialog Box" on page 522</a> .
<Toolbar>	The Show Impact pane toolbar contains most of the buttons on the IT Universe Manager toolbar.
<Topology Map Sidebar>	For details, see <a href="#">"Topology Map Sidebar" on page 176</a> .

# Chapter 8: Modeling Studio

This chapter includes:

Modeling Studio Overview .....	254
View Formats .....	255
Building a Business View .....	255
Templates and Perspectives .....	259
Predefined Folders and Views .....	260
Creating Template Based Views .....	261
Business CI Models .....	262
Building a Perspective-based View .....	264
Revealed CIs and Watchpoints .....	267
How to Create a Pattern View .....	271
How to Create a Template .....	273
How to Create a Perspective .....	274
How to Create a Dynamic Widget .....	276
How to Create a Template Based View .....	278
How to Create Multiple Template Based Views .....	280
How to Define Report Settings .....	281
How to Build an Instance-based Model .....	283
How to Build a New Pattern-based Model .....	284
How to Build a Perspective-based View Based on a Model .....	285
How to Build a Perspective-based View Based on a Collection of CIs .....	286
Modeling Studio User Interface .....	287

## Modeling Studio Overview

Modeling Studio is a tool for creating and managing views. You can create your own views, or work with the out-of-the-box (factory) views provided with your HP Universal CMDB installation.

The IT Universe model in the configuration management database can be very large, holding thousands of configuration items (CIs). A view enables you to build a subset of the overall IT universe model, containing only those CIs relating to a specific area of interest. You can define your own views to display only the information that is relevant to your organization's business needs.

HP Universal CMDB supports three view formats: pattern views, template based views, and perspective-based views, which are populated through different processes. For details, see ["View Formats" below](#).

## View Formats

HP Universal CMDB supports three view formats that can be used to populate your view:

- **Pattern views** are built from a Topology Query Language (TQL) query that defines the structure of the view. You can create a new TQL query as you build the view or base the view on an existing query. The view displays only those CIs and relationships that satisfy the query definition. When the view is displayed or refreshed, the Modeling Studio queries the CMDB for all elements that fit the query, and automatically updates the view with those elements.
- **Template based views** are based on a TQL query, to which a template is then applied. The template is a reusable view that includes parameters, which are saved as part of the template. This enables you to build multiple views with the same settings without having to re-enter the parameter information. The view displays only those CIs and relationships that satisfy the query definition and the conditions of the template. For details on templates, see ["Templates and Perspectives" on page 259](#).
- **Perspective-based views** are built by selecting a collection of individual CIs and applying a special type of template, known as a perspective, to it. Instance views, which no longer exist, are replaced by perspective-based views. For details on perspectives, see ["Templates and Perspectives" on page 259](#).

When you select a view for editing from the view tree in the left pane, it opens on the editing pane in the appropriate editor.

## Building a Business View

In the Modeling Studio, you can define your own views to model your business environment.

This section includes the following topics:

- ["The Structure of a View" below](#)
- ["Setting the View Hierarchy" on the next page](#)
- ["Topology Reports" on page 258](#)

## The Structure of a View

The views you create should provide the business users with logical representations of your company's structure, processes, and goals. To meet these requirements, you generally build multiple views representing different aspects of your business; for example, you could build business views that revolve around any of the following:

- Company structure, so that data is organized by the geographical location of branches, or by data centers.
- Business processes, so that data is organized by line of business, or by applications.
- Business goals, so that data is organized by sales, or by key customers.

The views depend on the particular demands of your organization and the actual hierarchical structure of the views should reflect those demands.

The usual hierarchical format of a view is as follows:

- **Top level.** The highest levels of the view, consisting of the root CI and the branches below it, are normally built from logical **Business** CI types such as **Location**, **Line of Business**, **Customer**, **Application**, and so on.
- **Intermediate level.** The intermediate branches of the view normally consist of **System** CI types, representing actual hardware and software and/or monitoring group CI types, representing groups containing monitors.
- **Bottom level.** The lowest level of the view, consisting of leaf CIs at the ends of the subtrees, is built from the **Monitor** CI types.

**Note:** The bottom level is only relevant when a monitoring solution such as HP Business Service Management is connected and modeled in the CMDB.



## Setting the View Hierarchy

The Pattern View Editor enables you to set the view hierarchy using the Hierarchy pane on the right side of the screen. There are two methods available for setting the hierarchy: **Manual** and **Rule-based**. The manual method is selected by default.

- Manual Hierarchy Method

In the manual hierarchy method, the query nodes of the view are displayed in a tree format. You can create the hierarchy by manually dragging a selected query node under another query node or by using the toolbar buttons. The system only allows you to move a query node under another query node when the resulting hierarchy is valid. For details, see ["Hierarchy Pane" on page 322](#).

It is possible to place a single query node from the view into the hierarchy multiple times. You can then adjust the hierarchy so that the query node appears in different layers, according to the required layout. The view results in such an instance would be the same as if you added another query node to the TQL query. Using the same query node twice in the hierarchy enables you to achieve the desired view results using a simpler TQL query.

### Query Node Grouping

When setting the view hierarchy manually, you can create subgroups to group CIs by different criteria for the convenience of viewing the display. Click the **Add Group By**  button and select one of the options. You can create a subgroup for CIs of the same type in the Topology Map using the **Add Group by CI Type** option. You can create a subgroup for a specific query node by selecting the **Add Group by View Node** option. You can group CIs by a common attribute using the **Add Group by Attribute** button and entering a regular expression as described in ["Query Node Grouping Dialog Box" on page 334](#). For details about regular expressions, see ["Regular Expression Examples" on page 574](#).

You can also create nested groups (a query node group inside another query node group) to help fine-tune the TQL query results that are displayed in the Topology Map.

For example, after grouping query nodes of type node by their CIT, you can use their **operation state** attribute to create more focused groups.

- Rule-Based Hierarchy Method

In the rule-based hierarchy method, you define hierarchy rules, using the Hierarchy Rules dialog box. You select a source CIT, target CIT, relationship type, and relationship direction, which define the conditions for a hierarchy rule. Any CIs in the view which satisfy the defined conditions are subject to

the rule, that is, the target CI is placed on the layer below the source CI. For details on defining hierarchy rules, see "[Hierarchy Rules Dialog Box](#)" on page 296.

## Hiding and Displaying Query Nodes in the View Results

You can select to hide certain query nodes so they do not appear in the view results. The following options are available:

- **Hide/Show Element in Query Results.** These options are available by right-clicking a query node in the Query Definition pane. CIs matching a query node that is set as hidden are excluded from the query results. You cannot set all of the query nodes as hidden; at least one query node must be shown for the query definition to be valid.
- **Set View Node Invisible/Visible.** These options are available by right-clicking a query node in the Hierarchy pane. CIs matching a query node that is set as invisible are excluded from the view results. However, if a function is defined in the Report Layout pane, it takes invisible query nodes into account. For example, a **Count** function will include CIs corresponding to invisible query nodes in the total count.

When a query node is set as invisible in the hierarchy, all of its descendants are automatically set as invisible. This enables you to hide an entire branch of the view results. The query definition cannot have visible query nodes under an invisible query node. When an invisible query node is set as visible, its descendants are not changed automatically.

A valid hierarchy definition must have at least one visible query node, other than the root query node. The root query node can never be set as invisible.

When the TQL query is calculated, UCMDB first filters the query results by the **Hide/Show Element in Query Results** settings. The query results are then filtered again by the **Set Query Node Invisible/Visible** settings. The final view results reflect the combination of both filters and are displayed in IT Universe Manager, the Result Preview in Modeling Studio, and the topology report for the view in Reports.

## Topology Reports

You can view the data of any view in report format in the Reports module. Such a report is called the **topology report** of the view. You define the topology report settings in the Report tab of the Pattern View Editor in the Modeling Studio. For details on Topology Reports, see "[Topology Reports Overview](#)" on page 356.

## Templates and Perspectives

A template is a reusable pattern view with defined parameters. You use templates to build template-based views, setting the values of the parameters for each specific view. Any changes made to a template affect all existing views based on that template.

Template-based views can be opened in IT Universe Manager, like pattern views. You can also open the template itself in IT Universe Manager to view the results for various parameter values. If you want to save the results, you must save it as a template-based view. You define templates, template-based views, and pattern views in the Pattern View Editor.

Perspectives are a type of template designed to be applied to a specific collection of CIs, similar to the pattern in a pattern view. For example, a perspective could comprise a node containing an IP Address. In that case, the resulting perspective-based view would include all the CIs from among the CIs in the CI selection, along with the IP Addresses contained in the node CIs.

The most basic perspective is known as the Content Only perspective and consists of only the query node itself. If you apply the Content Only perspective to a CI collection, the resulting view contains only the selected CIs themselves.

Perspectives are also created and edited in the Pattern View Editor. You can have multiple views, templates, and perspectives open in the Pattern View Editor simultaneously, each with its own tab.

Perspectives do not appear in the list of views in the IT Universe Manager; however, perspective-based views can be opened in the IT Universe Manager, like all other views. For details, see ["Building a Perspective-based View" on page 264](#).

In summary, the Views tree in the Resources tab of the CI Selector in the Modeling Studio can include the following distinct entities:

- pattern views
- templates
- template based views
- perspectives
- perspective-based views

You can filter the tree to select the types of views or templates to display.

The following table summarizes the types of views and where they are created and viewed:

Type of View	Created in:	Can be opened in IT Universe Manager
Pattern View	Pattern View Editor	Yes
Template	Pattern View Editor	Yes, for the current session only
Template-based View	Pattern View Editor	Yes
Perspective	Pattern View Editor	No
Perspective-based View	Perspective-based View Editor	Yes

## Predefined Folders and Views

The Views tree in the Resources tab of the CI Selector in the Modeling Studio includes predefined folders and views, as described in the following sections:

- ["Predefined Folders" below](#)
- ["Factory Views" below](#)
- ["Predefined Perspectives" on the next page](#)

### Predefined Folders

The hierarchical file folder system in the CI Selector can help you organize your views. Predefined folders are provided for the out-of-the-box views; you can modify these folders, or add additional folders according to your organization's requirements.

### Factory Views

Your HP Universal CMDB installation includes out-of-the-box pattern views, templates, and perspectives. These views provide a quick start for working with the CMDB.

The out-of-the-box views are initially empty. As soon as CIs are added to the CMDB by one of the CI generators, the TQL query built into each pattern view is able to identify the CIs that meet the pattern requirements, and add them to the view.

Views for CIs are created when a discovery process is run; the out-of-the-box views that are provided correspond to the relevant Universal Discovery packages. For example, the Oracle view (**Root > Database > Oracle > Oracle**) is populated with CIs that are created when Data Flow Management activates the Database - Oracle module. For details on running DFM, see "Module/Job-Based Discovery Workflow" in the *HP Universal CMDB Data Flow Management Guide*.

Some of the out-of-the-box views are considered basic to the system and cannot be deleted from the folders.

## Predefined Perspectives

HP Universal CMDB also provides out-of-the-box perspectives. One example is the Content Only perspective, which includes only the elements of the view content itself, without any additional CIs.

# Creating Template Based Views

Template-based views based on the same template contain the same query nodes and relationships. They differ only in their parameter values. You create template-based views using the Template-based View wizard. The wizard enables you to create multiple views at one time based on the same template. When creating multiple views, you have the option of entering parameter values manually or importing them from a CSV file. The CSV file must be formatted correctly for the wizard to import the values. It must contain the name of at least one of the template parameters in the first row and it must contain at least one record. The records should be in separate rows and the parameter values for each record should be in the same row, separated by commas.

The wizard also provides an Advanced Naming feature, which enables you to define an expression for the view names based on parameter values. For example, if your base template is called **Server\_Template**, and one of the template parameters is **Serial Number**, you could define the view names to be **Server <Serial Number>**. In this way, the wizard automatically inserts the respective value of the parameter Serial Number into the name of each view.

An alternate way to assign names to the views when importing values from a CSV file is to include a column in the file called **template\_based\_view\_name**. The file entries corresponding to this column are automatically entered by the wizard as the view names. Note that this naming method overrides the Advanced Naming feature; that is, view names are assigned the entries in the `template_based_view_name` column of the file, even when the Advanced Naming feature is selected.

For details on creating template-based views, see ["Template-based View Wizard" on page 343](#).

You can also edit the parameters of a template-based view when the view is open in the Editor, from the Template Parameter Values dialog box. For details, see ["Template Parameter Values Dialog Box" on page 348](#).

You cannot edit the report layout for a template-based view. To change the report layout, you need to make changes in the base template of the view.

## Business CI Models

This section includes the following topics:

- ["Instance-based Models" below](#)
- ["Pattern-based Models" on the next page](#)
- ["Defining a Pattern-based Model over an Instance-based Model" on page 264](#)

The collection of CIs which compose the view content of perspective-based views can be selected in two ways. You can select CIs from the CI Selector and drag them onto the editing pane. In this case, you can build a view by applying a perspective to the collection and the collection cannot be reused in another view without repeating the selection process. The other way to select the CIs to appear in the view is by creating a model.

A model is a reusable collection of CI instances that define a business entity, such as a business service or line of business. By creating a model, you are building a CI collection that can be reused with other perspectives to create different views. Any changes you subsequently make to the model are reflected in all the views based on that model. There are two types of models: instance-based models and pattern-based models.

### Instance-based Models

You build an instance-based model by first selecting a business CI to serve as its basis. The available business CIs include group, application, business service, business unit, and line of business. Then, you can add CIs to your model in the following ways:

- Manually, by dragging CIs from the CI Selector into the Model Editor
- Revealing related CIs using a reveal path and selecting the ones to add to the model
- Defining a watchpoint for a selected CI and automatically adding CIs to the model

You can also begin building a model by dragging CIs onto the empty canvas and selecting **Create a new model**.

The model you create is a CI itself and the CIs in your model are related to the model by **Contains** relationships. You must save your model before applying a perspective to it to build a view.

**Caution:** The changes you make in a model affect the entire universe, not just the views based on

that model. Thus, if you delete a CI from a model, you are deleting the relationship that existed between the CIs from the CMDB.

When working in IT Universe Manager, you can add selected CIs directly to a new model or an existing model. For details, see ["Add CIs to Model Dialog Box" on page 214](#).

## Pattern-based Models

Another type of model you can build is a pattern-based model. In a pattern-based model, you define a TQL query to determine the CIs included, rather than selecting them manually. You can base your pattern-based model on an existing TQL query or create a new TQL query.

You must designate at least one query node in the model's TQL query as output for the model. The CIs of that type which match the pattern of the TQL query are the ones included in the model output.

The pattern-based model created is saved as a CI like an ordinary model, and can be used to form the content of a perspective-based view. The new TQL query created is saved as an ordinary query and can be used as the basis for a pattern view.

Pattern-based models are not updated continuously. Each model is calculated at the time it is saved and the TQL query runs at specific intervals to update the model. All existing pattern-based models are updated at the same time. To set the frequency of the pattern-based model updates, click the  button in the Resources tab of the left pane to open the Pattern Based Model Scheduler dialog box. The settings you select also apply to all pattern-based models created subsequently. For details, see ["Pattern Based Model Scheduler Dialog Box" on page 318](#).

### Note:

- When you export a pattern-based model in Package Manager, the underlying TQL query of the model, as well as an enrichment used to update the model content, are added to the package. When you view the package resource, or deploy or undeploy the package, only those resources are displayed. The model name does not appear. A pattern-based model exported from UCMDDB 10.x cannot be imported into a UCMDDB version earlier than 10.00.
- When you delete a pattern-based model (either from the Modeling Studio or from the IT Universe), the Business Enrichment, Job Scheduler, and pattern-based model CI are also deleted.

## Defining a Pattern-based Model over an Instance-based Model

When defining a pattern-based model, it is possible to build it on top of an existing instance-based model. In this case, only the pattern of the model that you build is visible on the canvas, as in a new pattern-based model. However, the CIs in the instance-based model also remain in the new model and appear in the view results when the model is used to build a perspective-based view. Similarly, when you access the model in IT Universe Manager, both the CIs in the instance-based model and those retrieved by the pattern-based model are visible. The model is saved with the name of the original instance-based model, in effect creating a hybrid model with both instance-based and pattern-based components.

If you delete the model, only the additional pattern-based part of the model is deleted. The model reverts to an instance-based model and the CIs included in it become visible in the Model Editor.

## Building a Perspective-based View

A perspective-based view is composed of perspectives applied to a model or a collection of CIs. The perspective is a special type of template which is designed to be applied to a subset of the IT Universe model.

The Content pane of the Perspective-based View Editor displays the models or CIs you have selected to serve as the basis of your view. The Perspective pane displays the selected perspectives. The Preview pane displays the resulting view based upon your content and perspective selections. When you make a change in the content or perspective selections, the view is updated accordingly in the Preview pane. For details, see ["Perspective-based View Editor" on page 328](#).

This section includes the following topics:

- ["Content" below](#)
- ["Perspectives" on the next page](#)
- ["Views Based on Multiple Perspectives" on page 266](#)
- ["Including and Excluding Child CIs" on page 266](#)

### Content

The content in a perspective-based view can be selected in two ways:



- You can add individual CIs to the view manually, using the CI Selector. The CIs in the collection are independent of each other. In this case, the collection of CIs is not defined as a model and cannot be reused in another view.
- You can add one or more models to the view, using the CI Selector. Alternatively, you can start by working with a model in the Model Editor and select Generate View for Selected Model to build a view based on that model. In this case, the identical content can be used to build another view by selecting the same models.

You can select both individual CIs and models to form the content of a perspective-based view; however in that case, the models are treated as ordinary CIs. The models themselves are included in the view without their hierarchy of child CIs.

When working in IT Universe Manager, you can add selected CIs directly to the content of a new or an existing perspective-based view. For details, see ["Add CIs to View Dialog Box" on page 215](#).

## Perspectives

The perspectives you select for your view determine which CIs are included in the view. A perspective is a reusable pattern, similar to a template. The difference between a perspective and a regular template is that the perspective includes one or more query nodes designated as **contact query nodes**. A contact query node is a query node in the pattern which is used to apply the pattern to specific content and it is indicated by a small icon that appears next to the query node .

For example, in the following perspective, a query node of type Windows is designated as the contact query node and it has an IP Address related to it by a containment relationship.

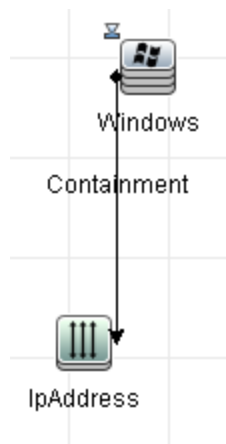

When this perspective is applied to a CI collection, the resulting view contains all the CIs in the original collection as well as the IP Addresses connected to the Windows CIs in the collection (the CIs that were added by applying the perspective).

A perspective can have several contact query nodes, but every disconnected graph within a perspective must have at least one contact query node.

If you make a change to a perspective, all views based on that perspective are affected.

## Views Based on Multiple Perspectives

You can select multiple perspectives to apply to the content of your view. There are two ways to select multiple perspectives:

- Perspective groups
- Perspective chains

In a **perspective group**, you select two or more perspectives to apply simultaneously to the same input content.

In a **perspective chain**, you select two or more perspectives at different levels of the view creation. The perspective in the first level is applied to the original view content to generate results in the form of a CI collection that serves as input content for the next level. The perspective in the second level is then applied to this content to generate the view results. You can build views based on multiple levels of perspectives, each one generating input content for the following level.

It is possible to apply both of the above methods at the same time, that is, by selecting multiple perspectives in each of the levels of a perspective selection.

For example, select a collection of **IP Subnet** CIs as your input content and select a perspective that adds the **node** CIs related to the IP Subnets as the first level perspective. The results of this stage consist of the original IP Subnets and their related nodes. Then add a second perspective level and select two perspectives for it: one that adds **CPU** CIs related to nodes and one that adds **File System** CIs related to nodes. The final results include the original IP Subnets, their related nodes, and the CPUs and File Systems related to those nodes.

These options help to simplify the process of creating a perspective-based view, by breaking down the functionality of a perspective into its component parts. Instead of building a separate large and complex perspective for each required view, you can construct a custom perspective combination to match the requirements of your specific case from smaller and more basic perspectives.

## Including and Excluding Child CIs

When adding CIs that have children to a view, the CI and its children are only included in the view if the pattern of the perspective includes children for the selected CI type. In that case, children are included for all CIs of that type. After creating a view, you can hide specific CIs from the view by selecting the CI in

the View Results pane and selecting **Hide CI from View** from the shortcut menu or clicking the **Hide CI from View** button on the toolbar. This option is only available for CIs that were added to the view via the perspective and were not part of the original content on which the view was based. Thus, if the view was based on a collection of CIs, the CIs in that collection cannot be hidden from the view. If the view was based on a model, the model itself cannot be hidden from the view, but the CIs contained in the model can be hidden.

## Revealed CIs and Watchpoints

The Modeling Studio provides two advanced methods of adding CIs to an existing model: revealing related CIs and defining watchpoints.

This section includes the following topics:

- ["Revealing CIs" below](#)
- ["Watchpoints" on page 270](#)

### Revealing CIs

One approach to building a model is to add CIs related to the CIs in the model. The Modeling Studio provides a tool to help you reveal those CIs. The process of revealing related CIs involves constructing a reveal path, which is a chain of CI types that are related to each other. The first item in your reveal path is the CI type of the CI from which you started to reveal CIs. The Modeling Studio locates all of its related CIs and lists their CI types. By selecting one of those types, you build the next step of your path. All the related CIs of that type appear in the lower pane of the dialog box. You can select the ones you want to include in your model. The process is repeated to build the following step of the path.

For example, if you begin to reveal CIs from a CI of type Windows, the Modeling Studio may reveal related CIs of types Interface, Network, and IP. If you select Network, the related CIs of type Network appear in the lower pane and can be added to the model by dragging them into the CIs Basket or clicking the CIs Basket icon:

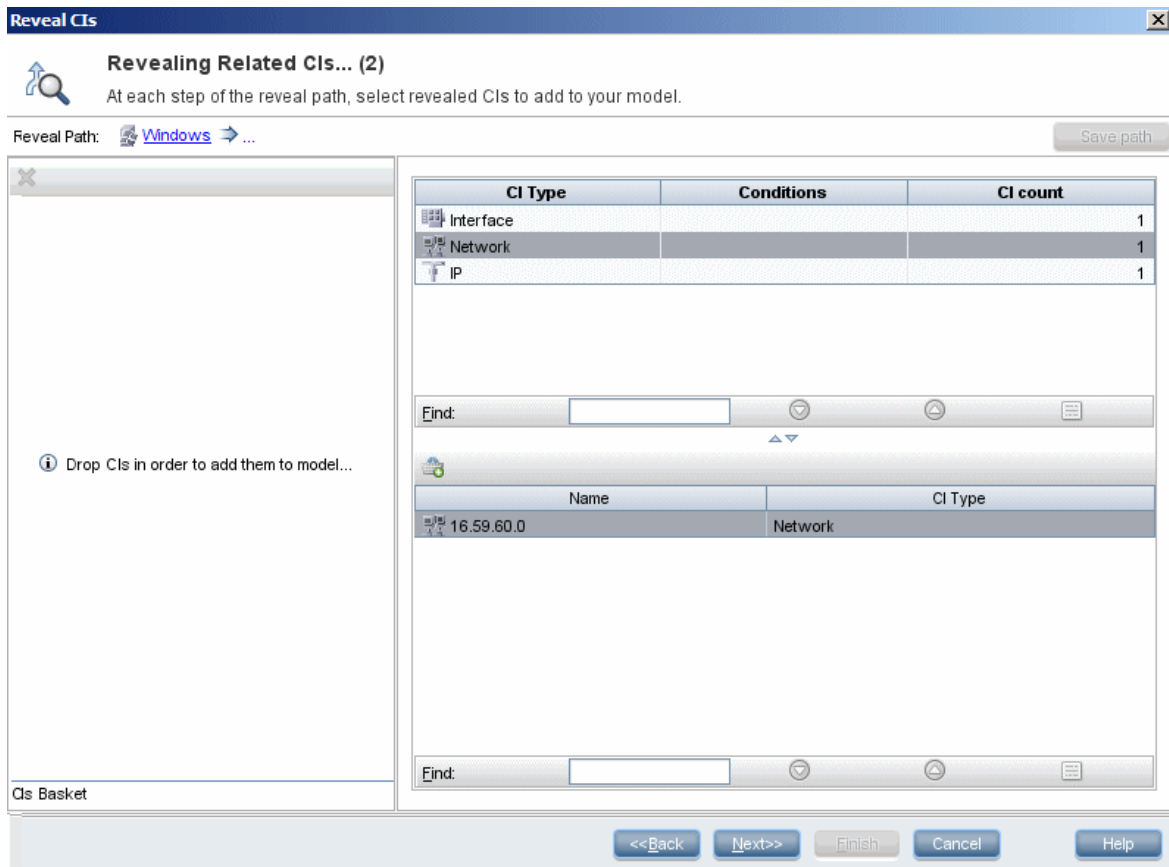

Click **Next** to build the next step of the path using Network as your selection. The Modeling Studio reveals related CIs of type Windows, Unix, and IP. Unix is selected and the Unix CIs appear in the lower pane and can be added to the model by dragging the selected ones into the CIs Basket pane:

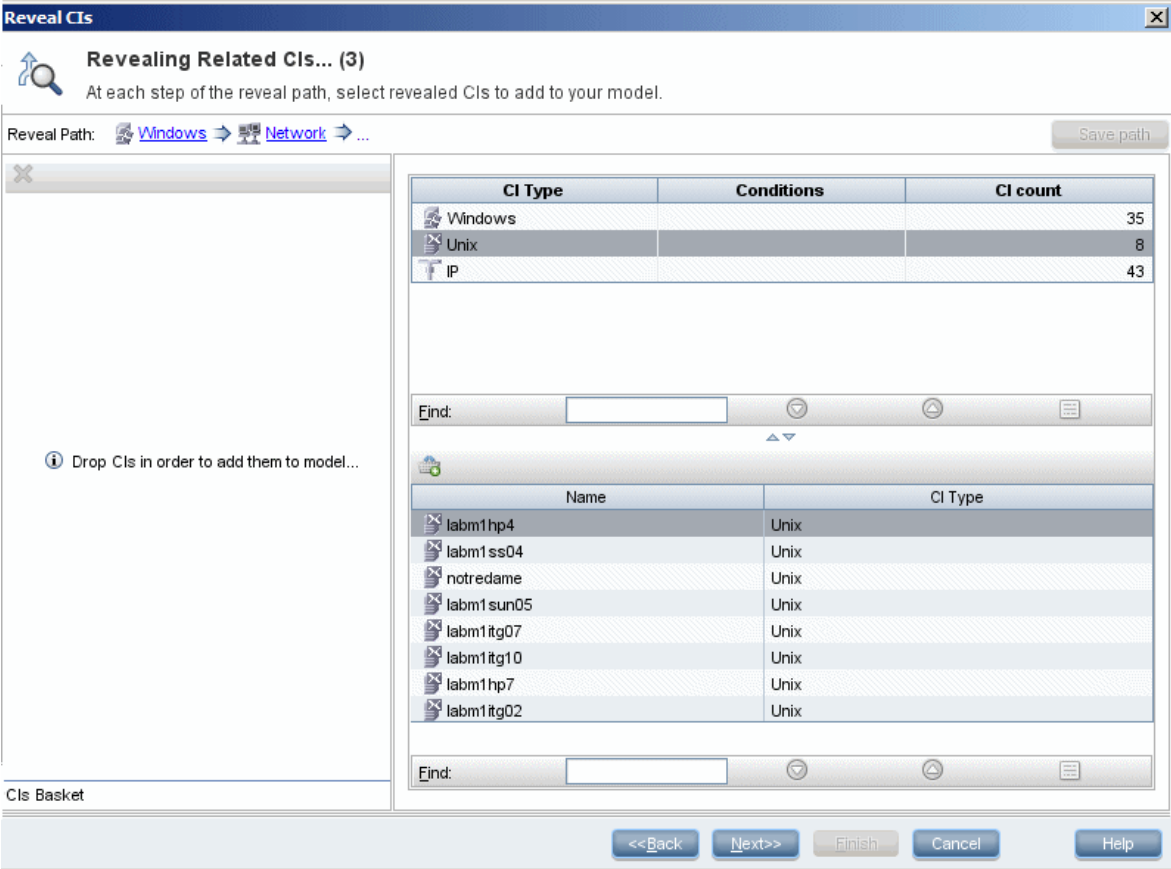

Click **Next** to build the next step of the path using Unix as your selection:

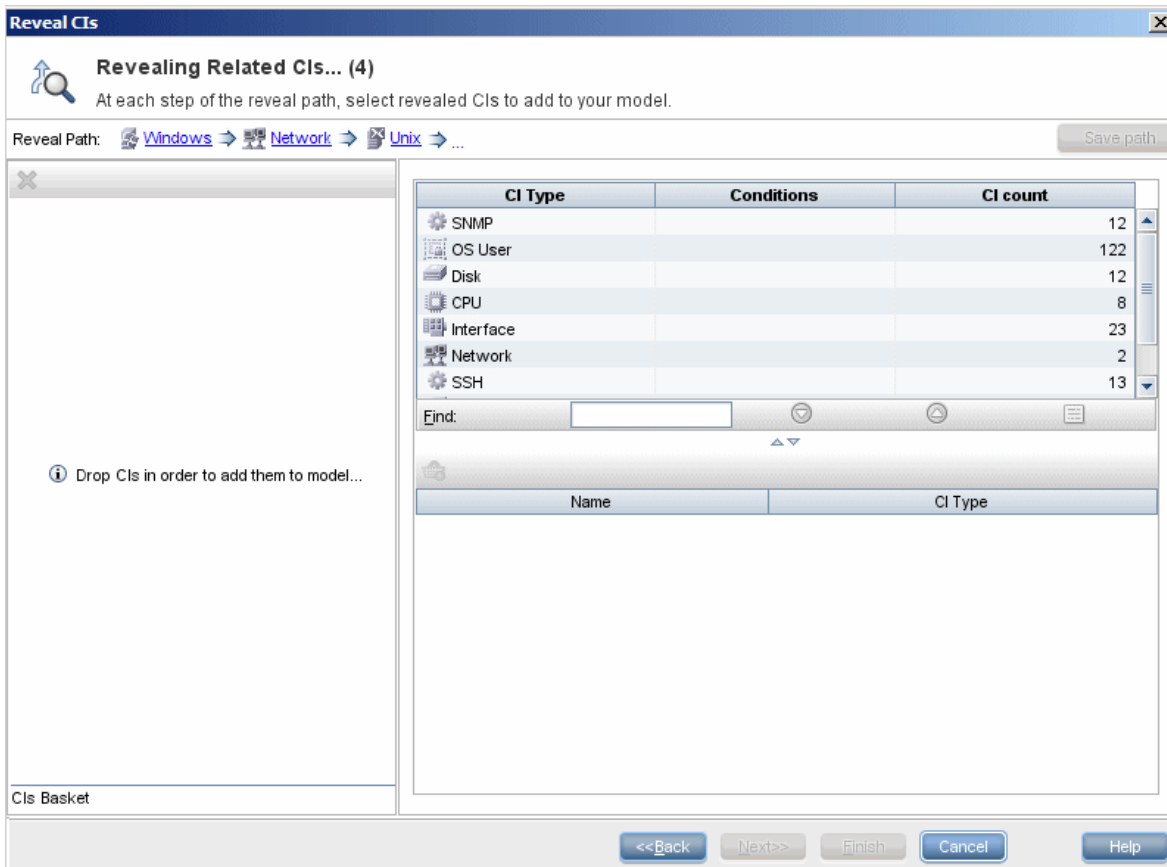

In this case, a reveal path of **Windows > Network > Unix** was constructed. At each step, you have the option of adding any of the revealed related CIs to your model. For details on revealing CIs, see ["Reveal CIs Dialog Box"](#) on page 337.

It is also possible to construct a reveal path without revealing CIs. For details, see ["Create/Edit/Save Reveal Path Dialog Box"](#) on page 293.

## Watchpoints

Another method of locating related CIs to add to the model is by defining a watchpoint for a selected CI in the model. A watchpoint is a mechanism which is triggered when a new related CI of a specified type is created. Every watchpoint is defined in connection with a reveal path. If a new related CI of any CI type included in the path is created, the watchpoint is triggered and an indicator appears next to the model. For details on defining a watchpoint, see ["New Watchpoint Dialog Box"](#) on page 316.

**Note:** You must save a new model before defining watchpoints for its CIs.

All the related CIs detected by the watchpoint are displayed in the Watchpoints Updates dialog box. The dialog box enables you to select the ones to add to your model and the ones to suppress, or exclude from your model. For details, see ["Watchpoints Updates Dialog Box" on page 354](#).

You also have the option to include the detected CIs in your model automatically by selecting the check box in the New Watchpoint dialog box. In this case, all CIs detected by the watchpoint are added to the model.

A watchpoint can also be used to detect CIs included in the model which are no longer related to the model. If such CIs are found along the reveal path connected to the watchpoint, they also appear in the Watchpoints Updates dialog box. You can accept the suggestion to remove the CIs from your model, or you can suppress the suggestion, thereby keeping the CIs in your model.

**Note:**

- Although a watchpoint is defined for an individual CI, the watchpoint results display related CIs of the CI types included in the reveal path for all CIs in the model.
- When adding CIs to a model using watchpoints or revealed CIs in a multi-tenancy environment, only CIs with a consumer tenant matching the owner tenant or consumer tenants of the model are added.

## How to Create a Pattern View

This task describes how to create a pattern view and define its TQL query.

This task includes the following steps:

- ["Open a New View in the Pattern View Editor" on the next page](#)
- ["Add Query Nodes and Relationships to a TQL Query" on the next page](#)
- ["Set the View Hierarchy" on the next page](#)
- ["Set the View Properties" on the next page](#)
- ["Define the Report Settings - Optional" on the next page](#)
- ["Set Permissions" on the next page](#)

## 1. Open a New View in the Pattern View Editor

Click **New**  and select **Pattern View**. In the New Pattern View dialog box, select the base TQL query on which your new view is based, or select **Create new query** to build a new TQL query. The Pattern View Editor opens. For details, see "[New Pattern View/Template/Perspective Dialog Box](#)" on [page 315](#).

## 2. Add Query Nodes and Relationships to a TQL Query

Add the query nodes and relationships that define the query. For details on how to add query nodes and relationships to a TQL query, see "[How to Add Query Nodes and Relationships to a TQL Query](#)" on [page 26](#).

**Note:** If you are starting with a blank view, you must add at least one query node in order to save your view.

## 3. Set the View Hierarchy

Set the hierarchy for the view by moving the required query nodes in the Hierarchy pane. For details, see "[Setting the View Hierarchy](#)" on [page 257](#).

When you are finished, click **Save**  to save the view.

## 4. Set the View Properties

Set the view properties, such as the priority and the default layout for the view in the View Definition Properties dialog box. For details, see "[Query/View Definition Properties Dialog Box](#)" on [page 335](#).

## 5. Define the Report Settings - Optional

Select the Report tab in the Pattern View Editor. Select the attributes you want to include in the report for each query node of the view. You can also set the order of the report columns, set the sort order of each column, and add a chart. For details, see "[How to Define Report Settings](#)" on [page 281](#).

## 6. Set Permissions

Apply viewing and editing permissions to users and user groups for the new view. You set permissions in **Managers > Security > Roles Manager**. For details, see "Roles Manager Page" in the



*HP Universal CMDB Administration Guide.*

## How to Create a Template

This task describes how to define a new template.

This task includes the following steps:

- ["Open a New Template in the Pattern View Editor" below](#)
- ["Add Query Nodes and Relationships to a TQL Query" below](#)
- ["Set Parameter Values" below](#)
- ["Set the Template Hierarchy" on the next page](#)
- ["Set the Template Properties" on the next page](#)
- ["Define the Report Settings - Optional" on the next page](#)
- ["Set Permissions" on the next page](#)

### 1. Open a New Template in the Pattern View Editor

Click **New**  and select **Template**. In the New Template dialog box, select the base TQL query on which your new template is based, or select **Create new query** to build a new TQL query. For details, see ["New Pattern View/Template/Perspective Dialog Box" on page 315](#).

### 2. Add Query Nodes and Relationships to a TQL Query

Add the query nodes and relationships that define the query. For details on how to add query nodes and relationships to a TQL query, see ["How to Add Query Nodes and Relationships to a TQL Query" on page 26](#).

**Note:** If you are starting with a blank template, you must add at least one query node in order to save your template.

### 3. Set Parameter Values

Right-click a query node or relationship in the TQL query and select Query Node Properties. In the

Attributes tab, add an attribute with a parameterized value. For details, see ["Query Node/Relationship Properties Dialog Box"](#) on page 73.

**Note:** If you do not set any parameters, when you try to save your template, you must save it as a pattern view.

#### 4. **Set the Template Hierarchy**

Set the hierarchy for the template by moving the required query nodes in the Hierarchy pane. For details, see ["Setting the View Hierarchy"](#) on page 257.

When you are finished, click **Save**  to save the template.

#### 5. **Set the Template Properties**

Set the template properties, such as the priority and the default layout for the template in the View Definition Properties dialog box. For details, see ["Query/View Definition Properties Dialog Box"](#) on page 335.

#### 6. **Define the Report Settings - Optional**

Select the Report tab in the Pattern View Editor. Select the attributes you want to include in the report for each query node of the view. You can also set the order of the report columns, set the sort order of each column, and add a chart. For details, see ["How to Define Report Settings"](#) on page 281.

#### 7. **Set Permissions**

Apply viewing and editing permissions to users and user groups for the new template. You set permissions in **Managers > Security > Roles Manager**. For details, see "Roles Manager Page" in the *HP Universal CMDB Administration Guide*.

## How to Create a Perspective

This task describes how to define a new perspective.

This task includes the following steps:

- ["Open a New Perspective in the Pattern View Editor" below](#)
- ["Add Query Nodes and Relationships to a TQL Query" below](#)
- ["Select a Contact Query Node" below](#)
- ["Set the Perspective Hierarchy" below](#)
- ["Set the Perspective Properties" on the next page](#)
- ["Define the Report Settings - Optional" on the next page](#)
- ["Set Permissions" on the next page](#)

### 1. Open a New Perspective in the Pattern View Editor

Click **New**  and select **Perspective**. In the New Perspective dialog box, select the base TQL query on which your new Perspective is based, or select **Create new query** to build a new TQL query. For details, see ["New Pattern View/Template/Perspective Dialog Box" on page 315](#).

### 2. Add Query Nodes and Relationships to a TQL Query

Add the query nodes and relationships that define the query. For details on how to add query nodes and relationships to a TQL query, see ["How to Add Query Nodes and Relationships to a TQL Query" on page 26](#).

### 3. Select a Contact Query Node

Select at least one query node in the TQL query to be a contact query node. Right-click the query node and select **Use As Contact Query Node**.

**Note:** If you do not select a contact query node, when you try to save your perspective, you must save it as a pattern view.

### 4. Set the Perspective Hierarchy

Set the hierarchy for the perspective by moving the required query nodes in the Hierarchy pane. For details, see ["Setting the View Hierarchy" on page 257](#).

When you are finished, click **Save**  to save the perspective.

## 5. Set the Perspective Properties

Set the perspective properties, such as the priority and the default layout for the perspective in the View Definition Properties dialog box. For details, see ["Query/View Definition Properties Dialog Box" on page 335](#).

## 6. Define the Report Settings - Optional

Select the Report tab in the Pattern View Editor. Select the attributes you want to include in the report for each query node of the view. You can also set the order of the report columns, set the sort order of each column, and add a chart. For details, see ["How to Define Report Settings" on page 281](#).

## 7. Set Permissions

Apply viewing and editing permissions to users and user groups for the new perspective. You set permissions in **Managers > Security > Roles Manager**. For details, see "Roles Manager Page" in the *HP Universal CMDB Administration Guide*.

# How to Create a Dynamic Widget

This task describes how to define a new dynamic widget for the UCMDB Browser.

This task includes the following steps:

- ["Create a New Dynamic Widget in the Pattern View Editor" below](#)
- ["Add Query Nodes and Relationships to a TQL Query" on the next page](#)
- ["Select Attributes for the Widget" on the next page](#)
- ["Set Values for the Widget's Attributes" on page 278](#)

## 1. Create a New Dynamic Widget in the Pattern View Editor

Click **New**  and select **Dynamic Widget**. In the New Dynamic Widget dialog box, select the base TQL query on which your new dynamic widget is based, or select **Create new query** to build a new TQL query.

## 2. Add Query Nodes and Relationships to a TQL Query

In the View tab, add the query nodes and relationships that define the query. For details, see ["How to Add Query Nodes and Relationships to a TQL Query" on page 26](#).

**Note:** The root (and only the root) of the folding definition in the TQL query must be designated as a contact query node for the dynamic widget to display data about that node in the UCMDB Browser. If no contact query node is specified, the TQL query is saved as a pattern view and not as a dynamic widget.

- a. Specify whether to use a manual (default) or rule-based hierarchy when defining the TQL query. For details, see ["Setting the View Hierarchy" on page 257](#).

**Note:** If you are starting with a blank widget, you must add at least one query node in order to save your widget.

- b. For each property for which you want data to be displayed in notifications in the dynamic widget, do the following:
  - i. Right-click a node in the topology map and select **Query Node Properties**.
  - ii. Click the Element Layout tab.
  - iii. Select the **Select attributes for layout** radio button.
  - iv. In the Conditions pane, select either **All** (to display all attributes of the selected node) or **Specific Attributes** (to display only the attributes you select).
  - v. Select attributes in the Available Attributes pane and click  to add them to the Specific Attributes pane.
  - vi. Click **OK** when you are finished.

## 3. Select Attributes for the Widget

In the Report tab, select a node in the Hierarchy pane, and choose the attributes for that node for which you want data to be displayed in the widget.

**Note:** In the Hierarchy pane in either the Report tab or the View tab, you can specify a grouping option on any node. Although you can choose between different grouping options, the CI's attributes are always displayed in groups by CI type when you view the dynamic widget in the UCMDDB Browser in Widget Details mode. To set a grouping option, right-click a node in the hierarchy tree and select one of the grouping options (attribute, CI type, or view node).

#### 4. Set Values for the Widget's Attributes

In the Widget tab, select a node and specify how and where you want the selected attributes to be visible in the widget. For details, see "[Pattern View Editor](#)" on page 321.

- Select the **Show path** check box to cause the UCMDDB Browser to display the route in the dynamic widget from a specific node in the view definition to all the node's children.
- Select the **Browser CI access control** check box to ensure that the dynamic widget displays data only according to the permissions that were specified on the Browser CI Access Control tab in the Roles manager. If the check box is not selected, the dynamic widget will display all data, without permission enforcement.
- Select an initial display mode for the dynamic widget.
  - **Properties Mode.** Displays individual properties for CIs.

**Note:** If you do not select a Widget Type value, Properties Mode is enabled by default.

- **Topology Map Mode.** Displays CIs according to your current topology.
- **Topology CIT Group Mode.** Displays CIs grouped by CI type according to your current model.
- **Topology Textual Mode.** Displays a list of CIs broken down by CI type.

The topology mode that you select is the initial view selection until you change to another one in the UCMDDB Browser.

When you are finished, click **Save** .

## How to Create a Template Based View

This task describes how to define a single template based view.

This task includes the following steps:

- ["Prerequisites" below](#)
- ["Define a New Template Based View" below](#)
- ["Select a Template" below](#)
- ["Select the Method for Adding Parameter Values" below](#)
- ["Set Parameters" below](#)
- ["Set Permissions" on the next page](#)

### 1. Prerequisites

If you want to base your view on a new template, create the template first. For details, see ["How to Create a Template" on page 273](#).

### 2. Define a New Template Based View

You define a new template based view using the Template-based View wizard. Click **New**  and select **Template Based View**.

### 3. Select a Template

On the Select Template page of the wizard, select a template on which to base your view. For details, see ["Select Template Page" on page 343](#).

### 4. Select the Method for Adding Parameter Values

On the Import Parameter Values page of the wizard, select the method for adding the parameter values. For details, see ["Import Parameter Values Page" on page 344](#).

### 5. Set Parameters

On the Enter Parameters page, enter the parameter values for the view. For details, see ["Enter Parameters Page" on page 345](#).

**Note:** You can also edit the parameters from within the Editor after creating the view, by selecting Show Parameters  from the toolbar or the shortcut menu.

When you are finished, click **Finish** to open the view in the Editor. Click **Save**  to save the view.

## 6. Set Permissions

Apply viewing and editing permissions to users and user groups for that view. You set permissions in **Managers > Security > Roles Manager**. For details, see "Roles Manager Page" in the *HP Universal CMDB Administration Guide*.

# How to Create Multiple Template Based Views

This task describes how to define multiple template-based views.

This task includes the following steps:

- ["Prerequisites" below](#)
- ["Define New Template Based Views" below](#)
- ["Select a Template" on the next page](#)
- ["Select the Methods for Adding Parameter Values and Naming Views" on the next page](#)
- ["Set Parameters" on the next page](#)
- ["Select the Location for Saving the Views" on the next page](#)
- ["Save the Views" on the next page](#)
- ["Set Permissions" on the next page](#)

## 1. Prerequisites

If you want to base your views on a new template, create the template first. For details, see ["How to Create a Template" on page 273](#).

## 2. Define New Template Based Views

You define new template based views using the Template-based View wizard. Click **New**  and select **Template Based View**.



### 3. **Select a Template**

On the Select Template page of the wizard, select a template on which to base your views. For details, see ["Select Template Page" on page 343](#).

### 4. **Select the Methods for Adding Parameter Values and Naming Views**

On the Import Parameter Values page of the wizard, select the method for adding the parameter values. Also, if you want to use the Advanced Naming feature, select the check box on this page. For details, see ["Import Parameter Values Page" on page 344](#).

### 5. **Set Parameters**

On the Enter Parameters page, enter the parameter values for the view. If you selected to import the parameter values from a CSV file, they are automatically entered in the table. You can edit the view names and parameter values manually on this page. You can also add new views to the table or delete views from the table. For details, see ["Enter Parameters Page" on page 345](#).

### 6. **Select the Location for Saving the Views**

On the Select Location page, select the location in the view tree in which to save the new views. For details, see ["Select Location for Views Page" on page 346](#).

### 7. **Save the Views**

On the Summary page, review the details of the views you created. If there are no further changes, click **Save** to save the views in the selected location.

### 8. **Set Permissions**

Apply viewing and editing permissions to users and user groups for each view created. You set permissions in **Managers > Security > Roles Manager**. For details, see "Roles Manager Page" in the *HP Universal CMDB Administration Guide*.

## How to Define Report Settings

This task describes how to define report settings for a view, template, or perspective.

This task includes the following steps:

- ["Prerequisites" below](#)
- ["Select Attributes to Appear as Report Columns" below](#)
- ["Add Function Columns to the Report - Optional" below](#)
- ["Set the Sort Order of the Column Content" below](#)
- ["Add a Chart to the Report - Optional" below](#)
- ["Set the Report Properties" on the next page](#)

### 1. Prerequisites

After defining the content and hierarchy of a view, template, or perspective, you can define the report settings. Select the Report tab in the Pattern View Editor.

### 2. Select Attributes to Appear as Report Columns

For each query node in the view, select the query node in the Hierarchy pane and select the attributes to appear as columns in the report for that query node. You select attributes in the Query Node Definition pane by moving them from the Attributes list to the Report Layout list. Set the order of the columns using the arrow buttons in the Report Layout list. For details, see ["Pattern View Editor" on page 321](#).

### 3. Add Function Columns to the Report - Optional

You have the option of adding a column for a selected query node consisting of data derived from a function performed on one of its child query nodes. Click the **Add Function**  button to open the Add Function dialog box where you can select the relevant settings. For details, see ["Add/Edit Function Dialog Box" on page 288](#).

### 4. Set the Sort Order of the Column Content

Click the **Set Sort Order**  button to open the Sort Column Content dialog box. Determine the columns by which to sort the report by moving columns from the Available Columns list to the Sorted Columns list. Use the arrow buttons to set the sort order of the columns. Use the Sort Ascending/Sort Descending buttons to set the sort direction for each column. For details, see ["Sort Column Content Dialog Box" on page 342](#).

### 5. Add a Chart to the Report - Optional

You have the option of adding a chart to your report, in place of a table, for a selected layer of the view. When the necessary conditions for adding a chart are satisfied, the **Define Chart** link in the Chart Properties section of the Query Node Definition pane is active. Click the link and enter the chart settings. For details, see "[Chart Properties](#)" on page 326.

## 6. Set the Report Properties

Select the View tab in the Pattern View Editor. Select the **Report Properties**  button to assign a title and subtitle to the report and to select the report format. For details, see "[Report Properties Dialog Box](#)" on page 434.

# How to Build an Instance-based Model

This task describes how to build an instance-based business CI model which can serve as the basis for a view.

This task includes the following steps:

- "[Create the New Model](#)" below
- "[Add CIs to the Model Manually](#)" below
- "[Reveal CIs](#)" on the next page
- "[Define Watchpoints for CIs in the Model](#)" on the next page

## 1. Create the New Model

In the Modeling Studio, click **New**  and select **Instance Based Model** to open the New Model dialog box. Select a CI type and enter the values for its properties. For details, see "[New Model Dialog Box](#)" on page 314.

**Note:** You cannot create an instance-based model with an already existing name.

## 2. Add CIs to the Model Manually

In the CI Selector, search for the CIs you want to include in your model. Select them and drag them into the model.

**Tip:** You can select more than one CI by holding the **CTRL** key while selecting CIs.

### 3. Reveal CIs

Select a CI in the model and reveal its related CIs along a reveal path. Add selected CIs from among the revealed CIs to your model. When you are done, save the model. For details, see "[Reveal CIs Dialog Box](#)" on page 337.

### 4. Define Watchpoints for CIs in the Model

Right-click a CI in the model and select **Watchpoint > New Watchpoint**. The New Watchpoint dialog box opens. Select a reveal path and click **OK**. A small icon appears next to the CI indicating that a watchpoint is defined for it. For details, see "[New Watchpoint Dialog Box](#)" on page 316.

## How to Build a New Pattern-based Model

This task describes how to build a new pattern-based model which can serve as the basis for a perspective-based view.

This task includes the following steps:

- "[Define the New Model](#)" below
- "[Enter the Model Details](#)" on the next page
- "[Select a TQL Query](#)" on the next page
- "[Add Query Nodes and Relationships to a TQL Query](#)" on the next page
- "[Set Output Query Nodes](#)" on the next page
- "[Save the Model](#)" on the next page

### 1. Define the New Model

You define a new pattern-based model using the Pattern-based Model wizard. Click **New**  and select **Pattern Based Model**.

**Note:** You cannot create a pattern-based model with an already existing name.

## 2. Enter the Model Details

On the first wizard page, select **New Model**. Then select a CI type for the model and enter the properties. For details, see "[Select CI Type Page](#)" on page 320.

## 3. Select a TQL Query

On the next wizard page, select a TQL query for the model. You can create a new TQL query or select an existing query from the tree. The TQL Query Editor opens with the selected query. For details, see "[Query Selection Page](#)" on page 320.

## 4. Add Query Nodes and Relationships to a TQL Query

Add the query nodes and relationships that define the query. For details on how to add query nodes and relationships to a TQL query, see "[How to Add Query Nodes and Relationships to a TQL Query](#)" on page 26.

## 5. Set Output Query Nodes

Select one or more query nodes in the TQL query to serve as output for the model by right-clicking them and selecting **Add to Model Output**. The query node is indicated by a small icon next to it.

## 6. Save the Model

When you are finished, save the model with a unique name. If you created a new TQL query, the query is also saved independently of the model and can be re-used as a regular TQL query.

# How to Build a Perspective-based View Based on a Model

This task describes how to build a view in the Modeling Studio based on a model and a perspective.

This task includes the following steps:

- "[Open the Model](#)" on the next page
- "[Select a Perspective](#)" on the next page
- "[Save the View](#)" on the next page

### 1. Open the Model

In the Modeling Studio, select **Models** as the Resource type in the left pane, select the relevant model, and click **Open Model**  on the left pane toolbar.

### 2. Select a Perspective

In the Model Editor, right-click the model and select **Generate View for selected model**. The Creating New View dialog box opens. Select perspectives to apply to the model. For details, see ["Creating New View Dialog Box" on page 294](#).

### 3. Save the View

The Perspective-based View Editor opens with your new view. Optionally, build a perspective chain by selecting perspectives for additional levels of the view creation. Rename the view and save it in the correct folder. For details, see ["Perspective-based View Editor" on page 328](#).

## How to Build a Perspective-based View Based on a Collection of CIs

This task describes how to build a view in the Modeling Studio based on a collection of CIs and a perspective.

This task includes the following steps:

- ["Create the New View" below](#)
- ["Add CIs to the View" below](#)
- ["Select a Perspective and Save the View" on the next page](#)

### 1. Create the New View

In the Modeling Studio, click **New**  and select **Perspective Based View** to open the Perspective-based View Editor. For details, see ["Perspective-based View Editor" on page 328](#).

### 2. Add CIs to the View

In the CI Selector, search for the CIs you want to include in your view. Select them and drag them into the view. For details on the CI Selector, see ["CI Selector" on page 135](#).

**Tip:** You can select more than one CI by holding the **CTRL** key while selecting CIs.

### 3. Select a Perspective and Save the View

In the Perspective pane, select perspectives to apply to your CI collection. Optionally, you can build a perspective chain by selecting perspectives for additional levels of the view creation. Rename the view and save it in the correct folder. For details, see ["Perspective-based View Editor" on page 328](#).

## Modeling Studio User Interface

This section includes (in alphabetical order):

Add/Edit Function Dialog Box .....	288
Change Query Node/Relationship Type Dialog Box .....	290
Choose Operation for Selected Items Dialog Box .....	291
Conditions of Related CIs Dialog Box .....	292
Create/Edit/Save Reveal Path Dialog Box .....	293
Creating New View Dialog Box .....	294
Cycle Definition Dialog Box .....	295
Hidden CIs Dialog Box .....	296
Hierarchy Rules Dialog Box .....	296
Left Pane .....	297
Manage CI Watchpoints Dialog Box .....	303
Model Editor .....	304
Modeling Studio Page .....	311
Models Containing Selected CI Dialog Box .....	313
New Model Dialog Box .....	314
New Pattern View/Template/Perspective Dialog Box .....	315
New Watchpoint Dialog Box .....	316

Open Reveal Path Dialog Box .....	317
Pattern Based Model Scheduler Dialog Box .....	318
Pattern Based Model Wizard .....	319
Pattern View Editor .....	321
Perspective-based View Editor .....	328
Query Node Grouping Dialog Box .....	334
Query/View Definition Properties Dialog Box .....	335
Reveal Cls Dialog Box .....	337
Save Query Dialog Box .....	339
Save View/Template/Perspective Dialog Box .....	340
Select Integration Points Dialog Box .....	341
Sort Column Content Dialog Box .....	342
Template-based View Wizard .....	343
Template Parameter Values Dialog Box .....	348
TQL Query Editor .....	348
Views Containing Selected CI Dialog Box .....	353
Watchpoints Updates Dialog Box .....	354
<Query/Template/Perspective Name> Dependencies Dialog Box .....	355

## Add/Edit Function Dialog Box

This dialog box enables you to define which of the query node's functions and parameters you want to include in the report.

<b>To access</b>	Click the <b>Add Function</b>  button under the Report Layout box in the Query Node Definition pane of the Pattern View Editor.
<b>Important information</b>	<p>When defining the report columns for a selected query node in a view, template, or perspective, you can define a column consisting of data deriving from a function defined for one of its child query nodes. Select the relevant child query node, attribute, and function that you want to define.</p> <p>First, select the required query node and function. The attribute list adjusts to display the relevant attribute for the selected combination. Select the required attribute.</p>



<b>Relevant tasks</b>	<a href="#">"How to Define Report Settings" on page 281</a>
<b>See also</b>	<ul style="list-style-type: none"> <li>• <a href="#">"Building a Business View" on page 255</a></li> <li>• <a href="#">"Modeling Studio User Interface" on page 287</a></li> </ul>

User interface elements are described below:



<b>UI Element (A-Z)</b>	<b>Description</b>
<b>Attribute</b>	Select an attribute from the list.
<b>Function</b>	<p>From the <b>Function</b> list, select the function you want to use to calculate the results on these columns.</p> <p>The following are the available options:</p> <ul style="list-style-type: none"> <li>• <b>Average.</b> The average value of the selected attribute for all the CI instances of the selected query node.</li> <li>• <b>Concatenated List.</b> Lists the values of the selected attribute for all the CI instances of the selected query node.</li> <li>• <b>Count.</b> Calculates the number of CI instances of the selected query node.</li> <li>• <b>Distinct List.</b> Lists the unique values of the selected attribute for all the CI instances of the selected query node.</li> <li>• <b>Max.</b> The maximum value of the selected attribute for all the CI instances of the selected query node.</li> <li>• <b>Min.</b> The minimum value of the selected attribute for all the CI instances of the selected query node.</li> <li>• <b>Sum.</b> The sum of the selected attribute values for all the CI instances of the selected query node.</li> </ul>
<b>Related Query Node</b>	The child query node on which you want to perform the function.
<b>Title</b>	The name of the function attribute displayed in the report.

## Change Query Node/Relationship Type Dialog Box

This dialog box enables you to change the CI type of a TQL query node or relationship after you have created a TQL query.

<b>To access</b>	In the TQL Query Editor or Pattern View Editor, right-click the required query node and select <b>Change Query Node Type</b> . For relationships, right-click the required relationship and select <b>Change Relationship Type</b> .
<b>Important information</b>	You can change the CI type of the selected query node to any other valid type based on the existing relationships and conditions of the selected query node.
<b>Relevant tasks</b>	<ul style="list-style-type: none"> <li>• <a href="#">"How to Define a TQL Query" on page 24</a></li> <li>• "Implement a Discovery Adapter" in the <i>HP Universal CMDB Developer Reference Guide</i></li> <li>• <a href="#">"How to Create a Pattern View" on page 271</a></li> </ul>
<b>See also</b>	<ul style="list-style-type: none"> <li>• <a href="#">"Building a Business View" on page 255</a></li> <li>• <a href="#">"Modeling Studio User Interface" on page 287</a></li> </ul>

User interface elements are described below (unlabeled elements are shown in angle brackets):

UI Element (A-Z)	Description
	<b>Expand All.</b> Expands all the folders in the tree.
	<b>Collapse All.</b> Collapses all the folders in the tree.
<b>Tree View</b> 	Click Tree View to select the display format of the CI type/Relationship tree. The following options are available: <ul style="list-style-type: none"> <li>• by Display label</li> <li>• by Class name</li> <li>• by Legacy class name</li> </ul>
<b>&lt;CI type/Relationship tree&gt;</b>	Select the required CI type or relationship.
<b>Relationship Direction</b>	Select the direction of the relationship.

UI Element (A-Z)	Description
	<p><b>Note:</b> Only relevant for relationships.</p>
<p><b>Relationship Name</b></p>	<p>The name of the relationship.</p> <p><b>Note:</b> Only relevant for relationships.</p>
<p><b>Relationship Restrictions</b></p>	<p>Select an option to define how to handle relationships between identical query nodes or self relationships in the query results. A self relationship is a relationship that leads from a query node to itself.</p> <ul style="list-style-type: none"> <li>• <b>Allow All Relationships.</b> All relationships appear in the query results.</li> <li>• <b>Allow Self Relationships only.</b> Only self-relationships (a relationship that leads to itself) appear in the query results.</li> <li>• <b>Allow Non Self Relationships only.</b> Self-relationships do not appear in the query results.</li> </ul> <p><b>Note:</b> Only relevant for relationships.</p>

## Choose Operation for Selected Items Dialog Box

This dialog box enables you to create models and views from selected CIs.

<b>To access</b>	In the Modeling Studio, drag CIs from the CI Selector onto the empty canvas.
<b>Important information</b>	You can drag individual or multiple CIs onto the canvas. You can select ordinary CIs and/or models to drag onto the canvas. To select multiple CIs, hold the <b>CTRL</b> key while selecting CIs.
<b>See also</b>	<ul style="list-style-type: none"> <li>• <a href="#">"Building a Business View" on page 255</a></li> <li>• <a href="#">"Business CI Models" on page 262</a></li> <li>• <a href="#">"Modeling Studio User Interface" on page 287</a></li> </ul>

User interface elements are described below:





UI Element (A-Z)	Description
<b>Create a new model</b>	Select to build a model comprising the CIs in your selection. If the CIs you dragged onto the canvas include at least one CI that has no valid links to any of the model CI types, this option is disabled.
<b>Create a new view</b>	Select to build a view based on the CI collection formed by your selection.
<b>Edit the model of the selected CI</b>	Select to edit the selected model in the Model Editor. <div style="background-color: #f0f0f0; padding: 5px; margin-top: 10px;"><b>Note:</b> This option only appears when a single model is dragged onto the canvas.</div>

## Conditions of Related CIs Dialog Box

This dialog box enables you to define conditions for the CI types in a reveal path.

<b>To access</b>	Click the <b>Add Condition</b> or <b>Edit Condition</b> button from the Conditions column of the Reveal CIs dialog box.
<b>See also</b>	<ul style="list-style-type: none"> <li>• <a href="#">"Revealed CIs and Watchpoints" on page 267</a></li> <li>• <a href="#">"Modeling Studio User Interface" on page 287</a></li> </ul>

User interface elements are described below:

UI Element (A-Z)	Description
	Add the attribute condition you have defined.
	Delete an attribute condition.
	Move a selected row up.
	Move a selected row down.
	View the condition definition.
<b>And/Or</b>	Click inside the <b>And/Or</b> field and select either <b>And</b> or <b>Or</b> to link multiple conditions.
<b>Attribute name</b>	Select an attribute from the list.

UI Element (A-Z)	Description
<b>( ) Brackets</b>	Click inside the <b>Brackets</b> box to display a list of brackets you can use to build more complex, logical statements.
<b>Criteria</b>	Contains the attribute condition definition as defined in the CI Instances dialog box.
<b>Not</b>	Select <b>NOT</b> if you want the condition statement to do the opposite of what is defined.  <div style="border: 1px solid #ccc; background-color: #f0f0f0; padding: 10px; margin-top: 10px;"> <p><b>Note:</b> If you select <b>NOT</b>, query results do not include data from the CI instances that were not assigned a value. For example, your system contains three node CIs: Node1 is assigned the value A, Node2 is assigned the value B and Node3 is not assigned a value. You create a query to retrieve all nodes that are equal to A and select <b>NOT</b>; the results of your query only include Node2 because Node3 is not assigned a value.</p> </div>
<b>Operator</b>	Select the required operator. For details, see <a href="#">"Attribute Operator Definitions" on page 40</a> .
<b>Value</b>	Enter or select the value of the attribute. The <b>Value</b> options vary according to the attribute type you select.

## Create/Edit/Save Reveal Path Dialog Box

This dialog box enables you to define a new reveal path or edit an existing path.

<b>To access</b>	<p>To define a new reveal path, click the <b>Reveal</b>  button from the Model Editor, and select <b>Create Reveal Path</b>.</p> <p>To edit an existing reveal path, select a path from the Open Reveal Path dialog box and click <b>Edit</b>.</p> <p>To save a reveal path, click <b>Save Path</b> from the Reveal CIs dialog box.</p>
<b>See also</b>	<ul style="list-style-type: none"> <li>• <a href="#">"Revealed CIs and Watchpoints" on page 267</a></li> <li>• <a href="#">"Modeling Studio User Interface" on page 287</a></li> </ul>

User interface elements are described below:

UI Element (A-Z)	Description
<b>Description</b>	Enter a description of the path.
<b>Name</b>	Enter the name of the path.
<b>Preview</b>	Opens the Reveal CIs dialog box displaying the related CIs in the path.  <div style="background-color: #f0f0f0; padding: 5px;"> <b>Note:</b> This button does not appear in the Save Reveal Path dialog box.                     </div>
<b>Reveal Path</b>	Build the path by clicking the  button to open a dialog box with a CI type tree. Select the CI type for the next item in the path.  When you hold the pointer over a reveal path item, the following options are available: <ul style="list-style-type: none"> <li>• <b>Delete Selected Item(s).</b> Deletes the selected item from the reveal path.</li> <li>• <b>Add condition.</b> Opens the Conditions of Related CIs dialog box, which enables you to set conditions for the reveal path item.</li> <li>• <b>Refine Query Node Type.</b> Opens a CI type tree, which enables you to change the CI type of the reveal path item.</li> </ul>

## Creating New View Dialog Box

This dialog box enables you to select a perspective to create a view from a model.

<b>To access</b>	In the Modeling Studio, right-click a model in the Model Editor, Perspective-based View Editor, or CI Selector and select <b>Generate view for selected Model</b> or click the <b>Generate view for selected model</b>  button from the Model Editor.
<b>Important information</b>	You select perspectives in the left pane and move them to the right pane using the arrow buttons.
<b>Relevant tasks</b>	<a href="#">"How to Build a Perspective-based View Based on a Model " on page 285</a>
<b>See also</b>	<ul style="list-style-type: none"> <li>• <a href="#">"Building a Business View" on page 255</a></li> <li>• <a href="#">"Modeling Studio User Interface" on page 287</a></li> </ul>

User interface elements are described below (unlabeled elements are shown in angle brackets>):

UI Element (A-Z)	Description
<b>Available Perspectives</b>	A list of the available perspectives to apply to your model.
<b>Selected Perspectives</b>	The perspectives you selected to apply to your model.

## Cycle Definition Dialog Box

This dialog box enables you to define a cyclical hierarchy in a view.

<b>To access</b>	In the Modeling Studio, right-click a query node in the Hierarchy pane of the Pattern View Editor and select <b>Define Cycles</b> .
<b>Important information</b>	You can extend the TQL query definition of a view by defining a cycle in the view hierarchy. Select a query node in the Hierarchy pane to be the source query node. The Cycle Definition dialog box displays the valid target query nodes for that source. The target query node in the cycle, along with its hierarchy, is treated as a child or sibling of the source query node (depending on your folding rule selection).
<b>Relevant tasks</b>	<a href="#">"How to Create a Pattern View" on page 271</a> , <a href="#">"How to Create a Template" on page 273</a> , <a href="#">"How to Create a Perspective" on page 274</a>
<b>See also</b>	<ul style="list-style-type: none"> <li>• <a href="#">"Building a Business View" on page 255</a></li> <li>• <a href="#">"Modeling Studio User Interface" on page 287</a></li> </ul>

User interface elements are described below (unlabeled elements are shown in angle brackets>):

UI Element (A-Z)	Description
<b>Folding Rule</b>	Select one of the following options: <ul style="list-style-type: none"> <li>• <b>Folded cycle under source.</b> The target query node becomes a child of the source query node.</li> <li>• <b>Flattened cycle under parent.</b> The target query node becomes a sibling of the source query node.</li> </ul>
<b>Target</b>	Displays the valid target query nodes for the selected source query node. A query node is defined as a valid target query node if all of the following conditions are true: <ul style="list-style-type: none"> <li>• it is related to the source query node</li> <li>• it is an ancestor of the source query node (or the source query node itself)</li> </ul>

UI Element (A-Z)	Description
	<ul style="list-style-type: none"> <li>it is a query based node (not a grouping node)</li> </ul>

## Hidden CIs Dialog Box

This dialog box enables you to restore hidden CIs to a view.

<b>To access</b>	From the Perspective-based View Editor, click the <b>Show Hidden CIs</b> button from the toolbar of the View Results pane.
<b>See also</b>	<ul style="list-style-type: none"> <li><a href="#">"Building a Perspective-based View" on page 264</a></li> <li><a href="#">"Modeling Studio User Interface" on page 287</a></li> </ul>

User interface elements are described below (unlabeled elements are shown in angle brackets):

UI Element (A-Z)	Description
<check box>	Select the check boxes for the CIs you want to restore.
<b>CI Type</b>	The CI type of the excluded CI.
<b>Name</b>	The name of the excluded CI.
<b>Restore</b>	Click <b>Restore</b> to include the selected CIs in the view.
<b>Select All</b>	Click <b>Select All</b> to select all the CIs in the list for inclusion in the view.
<b>Unselect All</b>	Click <b>Unselect All</b> to clear the check boxes of all the CIs in the list.

## Hierarchy Rules Dialog Box



This dialog box enables you to set the hierarchy of a view by defining hierarchy rules.

<b>To access</b>	From the Hierarchy pane of the Pattern View Editor, when <b>Rule Based</b> is selected as the hierarchy method, click the <b>Add Hierarchy Rule</b>  button from the toolbar.
<b>Important information</b>	For each hierarchy rule you define, select a source CI type, target CI type, relationship, and direction.
<b>Relevant tasks</b>	<a href="#">"How to Create a Pattern View" on page 271</a> , <a href="#">"How to Create a Template" on page 273</a> , <a href="#">"How to Create a Perspective" on page 274</a>



<b>See also</b>	<ul style="list-style-type: none"> <li>• <a href="#">"Building a Business View" on page 255</a></li> <li>• <a href="#">"Modeling Studio User Interface" on page 287</a></li> </ul>
-----------------	--

User interface elements are described below (unlabeled elements are shown in angle brackets>):

UI Element (A-Z)	Description
	<b>Add.</b> Adds a hierarchy rule.
	<b>Delete.</b> Deletes the selected hierarchy rule.
<b>Relationship</b>	Select a relationship from the drop-down list to edit the selected hierarchy rule.
<b>Relationship Direction</b>	Select a direction from the drop-down list to edit the selected hierarchy rule.
<b>Source</b>	Select a CI type for the source CI type from the drop-down tree to edit the selected hierarchy rule.
<b>Target</b>	Select a CI type for the target CI type from the drop-down tree to edit the selected hierarchy rule.

## Left Pane

This area enables you to browse views (including dynamic widgets) and TQL queries, search for CIs or models to open in the Editor pane, and select CI types to use in the TQL Query Editor or Pattern View Editor.







<b>To access</b>	Located to the left of the Editor pane in Modeling Studio.
<b>Important information</b>	<p>The following tabs are available:</p> <ul style="list-style-type: none"> <li>• <b>Resources.</b> Enables you to select a model, view, or TQL query to open in the Editor pane.</li> <li>• <b>CI Selector.</b> See <a href="#">"CI Selector" on page 135</a>.</li> <li>• <b>CI Types.</b> Enables you to select CI types from the tree to add as a query node to your TQL query.</li> </ul>
<b>See also</b>	<ul style="list-style-type: none"> <li>• <a href="#">"Templates and Perspectives" on page 259</a></li> <li>• <a href="#">"Modeling Studio User Interface" on page 287</a></li> </ul>









## Resources Tab



<b>Important information</b>	When <b>Views</b> or <b>Queries</b> is selected as the resource type, you can drag and drop views, queries, or folders to move them from one folder to another.
------------------------------	---

User interface elements are described below (unlabeled elements are shown in angle brackets>):

UI Element (A-Z)	Description
	<p><b>New Folder.</b> Creates a new folder in the resource tree.</p> <p><b>Note:</b> This button only appears when <b>Queries</b> or <b>Views</b> are selected as the resource type.</p>
	<p><b>Delete.</b> Deletes the selected resource from the CMDB.</p> <p><b>Note:</b> When you delete a resource with dependent resources, the dependent resources are also deleted. Dependent resources can include queries, views, or custom reports.</p>
	<p><b>Refresh.</b> Refreshes the resource tree.</p>
	<p><b>Expand All.</b> Expands all the folders in the resource tree.</p> <p><b>Note:</b> This button only appears when <b>Queries</b> or <b>Views</b> are selected as the resource type.</p>
	<p><b>Collapse All.</b> Collapses all the folders in the resource tree.</p> <p><b>Note:</b> This button only appears when <b>Queries</b> or <b>Views</b> are selected as the resource type.</p>
	<p>When <b>Queries</b> or <b>Views</b> are selected as the resource type, click <b>Hide Empty Folders</b> to display only folders containing views or TQL queries.</p> <p>When <b>Models</b> is selected as the resource type, click <b>Show only models with content</b> to display only models containing CIs.</p>
	<p><b>Filter Tree/Table.</b></p> <p>When <b>Views</b> is selected as the resource type, click <b>Filter Tree</b> to filter the types of</p>

UI Element (A-Z)	Description
	<p>views, templates, and dynamic widgets that appear in the tree.</p> <p>When <b>Queries</b> is selected as the resource type, click <b>Filter Tree</b> to filter the TQL queries that appear in the tree by query type.</p> <p>When <b>Models</b> is selected as the resource type, click <b>Filter Table</b> to filter the models in the table by CI type.</p>
	<p><b>Filter Tree by Bundle.</b> Allows you to filter queries or views by predefined bundle.</p> <p>If you select more than one bundle from the available list, each resource that belongs to at least one of the bundles is displayed.</p> <p><b>Note:</b> This button is active only when the Filterable Bundles List setting is configured in the Infrastructure Settings Manager. For details, see "Infrastructure Settings Manager Page" in the <i>HP Universal CMDB Administration Guide</i>.</p>
	<p><b>Open Query.</b> Opens the selected TQL query in a new tab.</p> <p><b>Note:</b> This button only appears when <b>Queries</b> is selected as the resource type.</p>
	<p><b>Open View.</b> Opens the selected view in a new tab.</p> <p><b>Note:</b> This button only appears when <b>Views</b> is selected as the resource type.</p>
	<p><b>CI Properties.</b> Enables you to view the properties of the selected model.</p> <p><b>Note:</b> This button only appears when <b>Models</b> is selected as the resource type.</p>
	<p><b>Show views containing selected CI/model.</b> Displays a list of views including the selected CI or model.</p> <p><b>Note:</b> This button only appears when <b>Models</b> is selected as the resource type.</p>
	<p><b>Open Model.</b> Opens the selected model in the Model Editor.</p> <p><b>Note:</b> This button only appears when <b>Models</b> is selected as the resource type.</p>

UI Element (A-Z)	Description
	<p><b>Pattern Based Model Scheduler.</b> Enables you to modify the starting time and repeat interval for all pattern-based models.</p> <p><b>Note:</b> This button only appears when <b>Models</b> is selected as the resource type.</p>
	<p><b>Assign Tenants.</b> Opens the Assign Tenants dialog box which enables you to assign tenants to a model.</p> <p><b>Note:</b></p> <ul style="list-style-type: none"> <li>• This button only appears when <b>Models</b> is selected as the resource type.</li> <li>• This button is only available when multi-tenancy is enabled.</li> </ul>
	<p><b>Import From XML.</b> Enables you to import XML files that contain saved views or queries to the Modeling Studio.</p> <p><b>Note:</b> This button only appears when <b>Queries</b> or <b>Views</b> are selected as the resource type.</p>
	<p><b>Export To XML.</b> Enables you to export the view or query as an XML script. This option can be used to move a view or query from one workstation to another.</p> <p><b>Note:</b> This button only appears when <b>Queries</b> or <b>Views</b> are selected as the resource type.</p>
<p><b>&lt;Resources&gt;</b></p>	<p>When <b>Views</b> or <b>Queries</b> is selected as the resource type, the available views or TQL queries are displayed under their respective folders in tree format. When <b>Models</b> is selected as the resource type, the available models are displayed in a table.</p> <p>For views, the following view types are included:</p> <ul style="list-style-type: none"> <li>•  Denotes a pattern view.</li> <li>•  Denotes a template.</li> <li>•  Denotes a template-based view.</li> <li>•  Denotes a perspective.</li> </ul>

UI Element (A-Z)	Description
	<ul style="list-style-type: none"> <li>•  Denotes a perspective-based view.</li> <li>•  Denotes an automation flow mapping. Only relevant when the Automation Flow Adapter has been deployed. For details, see the UCMDB Browser documentation.</li> <li>•  Denotes a dynamic widget.</li> </ul>
<b>Resource Type</b>	<p>Select the resource type to display in the pane. The available options are Models, Views, and Queries.</p> <div style="background-color: #f0f0f0; padding: 10px; border: 1px solid #ccc;"> <p><b>Note:</b> The maximum number of models to be loaded into the Modeling Studio is set to 400,000 by default. To change this setting, change the <b>Maximum number of models in view result</b> setting in the Infrastructure Settings Manager. For details, see "Infrastructure Settings Manager Page" in the <i>HP Universal CMDB Administration Guide</i>.</p> </div>

### Resources Tab Shortcut Menu

The Resources tab includes the following elements (listed alphabetically) available by right-clicking a resource:





Menu Item	Description
<b>Assign Tenants</b>	Open the Assign Tenants dialog box which enables you to assign tenants to the resource.
<b>Create a new View/Template/Perspective</b>	Create a new view, template, or perspective.
<b>Delete</b>	<p>Delete the selected resource from the CMDB.</p> <div style="background-color: #f0f0f0; padding: 10px; border: 1px solid #ccc;"> <p><b>Note:</b> When you delete a resource with dependent resources, the dependent resources are also deleted. Dependent resources can include queries, views, or custom reports.</p> </div>
<b>Export To XML</b>	Export the view or query as an XML script. This option can be used to move a view or query from one workstation to another.
<b>Manage Security</b>	Assign the selected resource to specific roles or resource groups.

Menu Item	Description
	<b>Note:</b> This option is not relevant for models.
<b>New Folder</b>	Create a new folder in the resource tree.
<b>New Template Based View</b>	Edit the parameters of the selected template to define a new template-based view.  <b>Note:</b> This option is only active when a template is selected in the view tree.
<b>Open Query/View/Model</b>	Open the selected view, TQL query, or model in a new tab.
<b>Properties</b>	Opens the CI Properties dialog box for the selected model.  <b>Note:</b> This option is only relevant for models.
<b>Refresh</b>	Refresh the resource tree.
<b>Remove</b>	Remove the selected model.  <b>Note:</b> This option is only relevant for models.
<b>Rename Folder</b>	Rename the selected folder.
<b>Save As</b>	Save the selected TQL query with a new name.
<b>Show containing views</b>	Opens the Views containing selected CI dialog box for the selected model.  <b>Note:</b> This option is only relevant for models.

## CI Types Tab

User interface elements are described below (unlabeled elements are shown in angle brackets>):

UI Element (A-Z)	Description
	<b>Expand All.</b> Expands all the folders in the CI Type tree.

UI Element (A-Z)	Description
	<b>Collapse All.</b> Collapses all the folders in the CI Type tree.
<b>Tree View</b> 	Displays the format of the CI type tree. The following options are available: <ul style="list-style-type: none"> <li>• by Display label</li> <li>• by Class name</li> <li>• by Legacy class name</li> </ul>
	<b>Add Selected CITs to Query.</b> Adds the selected CI type to the TQL query which is open in the Editor pane.  <div style="background-color: #f0f0f0; padding: 5px;"><b>Note:</b> This button is only active when a view or TQL query is open in the Editor pane.</div>
	<b>Refresh.</b> Refreshes the CI Type tree.
<b>&lt;CI Type tree&gt;</b>	The available CI types are displayed in tree format.

### CI Types Tab Shortcut Menu

The CI Types tab includes the following elements (listed alphabetically) available by right-clicking a CI type:



Menu Item	Description
<b>Add Selected CITs to Query</b>	Select to add the selected CI type to the TQL query open in the Editor pane.
<b>Go to CI Type Definition</b>	Takes you directly to the selected CI type in CIT Manager.
<b>Show Element Instances</b>	Opens the CI Instances window, which displays all instances of the selected CIT. For details, see " <a href="#">CI Instances Dialog Box</a> " on page 66.

## Manage CI Watchpoints Dialog Box

This dialog box enables you to add or remove watchpoints for a CI in a model.

<b>To access</b>	From within a model in the Model Editor, click the <b>Watchpoint</b>  button and select <b>Manage CI Watchpoints</b> or right-click a CI in the model and select <b>Watchpoint &gt; Manage CI Watchpoints</b> .
<b>See also</b>	<ul style="list-style-type: none"> <li>• <a href="#">"Revealed CIs and Watchpoints" on page 267</a></li> <li>• <a href="#">"Modeling Studio User Interface" on page 287</a></li> </ul>

User interface elements are described below:

<b>UI Element (A-Z)</b>	<b>Description</b>
 <b>Add</b>	Opens the New Watchpoint dialog box which enables you to add a new watchpoint.
 <b>Remove</b>	Deletes the selected watchpoint.
<b>Automated</b>	A check mark indicates that the new CIs found by the watchpoint are to be added to the view automatically.
<b>Source CI</b>	Displays the CI forming the beginning of the reveal path.
<b>Watchpoint Name</b>	The name of the reveal path associated with the watchpoint.
<b>Watchpoint Path</b>	Displays the reveal path for the watchpoint.

## Model Editor

This feature enables you to create and edit models.











<b>To access</b>	In the Modeling Studio, click the <b>New</b>  button and select <b>Instance Based Model</b> to create a new model or select <b>Models</b> as the Resource type and open an existing model.
<b>Important information</b>	<p>The Model Editor contains the following panes:</p> <ul style="list-style-type: none"> <li>• <b>Content pane.</b> Lists the CIs and models contained in the model.</li> <li>• <b>Information pane.</b> Displays the properties, related CIs and watchpoints for the selected CI or model.</li> </ul> <p>You can drag CIs from the CI Selector into the Content pane of an existing model to add them to the model. However, you cannot drag in a CI that is already included in the model.</p>















	You can drag CIs from the CI Selector into the Related CIs tab of the Information pane provided that the selected source and target CI can be related by a <b>usage</b> relationship.
<b>Relevant tasks</b>	<a href="#">"How to Build an Instance-based Model " on page 283</a>
<b>See also</b>	<ul style="list-style-type: none"> <li>• <a href="#">"Business CI Models" on page 262</a></li> <li>• <a href="#">"Modeling Studio User Interface" on page 287</a></li> </ul>

## Content Pane

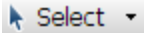
User interface elements are described below:

UI Element (A-Z)	Description
 Map	<b>Map.</b> Displays the CIs as icons in a diagram.
 Text	<b>Text.</b> Displays the CIs in a list.
	<b>CI Properties.</b> Opens the Configuration Item Properties dialog box for the selected CI.
	<b>Show models containing selected CI.</b> Displays a list of the models containing the selected CI.
	<b>Show views containing selected CI/model.</b> Displays a list of the views containing the selected CI or model.
	<b>Open selected model in a new tab.</b> Opens the selected model in a separate Model Editor tab.
	<b>Generate view for selected model.</b> Enables you to create a view based on the current model. The Creating New View dialog box opens, which enables you to select a perspective to apply.
	<b>Remove Selected CI(s) from the Model.</b> Removes a selected CI from the model (it remains in the CMDB).
	<b>Insert new model</b> Opens the New Model dialog box which enables you to define a new model within the existing model.
	<b>Expand All.</b> Expands the model hierarchy.
	<b>Collapse All.</b> Collapses the model hierarchy.

UI Element (A-Z)	Description
	<p><b>Reveal.</b> Includes the following options:</p> <ul style="list-style-type: none"> <li>• <b>Start Revealing.</b> Opens the Reveal CIs dialog box. For details, see Reveal CIs dialog box.</li> <li>• <b>Create Reveal Path.</b> Opens the Create Reveal Path dialog box. For details, see Create Reveal Path dialog box.</li> <li>• <b>Open Reveal Path.</b> Opens the Open Reveal Path dialog box. For details, see Open Reveal Path dialog box.</li> </ul>
	<p><b>Watchpoint.</b> Includes the following options:</p> <ul style="list-style-type: none"> <li>• <b>Watchpoints Updates.</b> Enables you to display the watchpoint results and select CIs to add to the model. For details, see Watchpoints Updates dialog box.</li> <li>• <b>New Watchpoint.</b> Enables you to define a new watchpoint for the selected CI. For details, see New Watchpoint dialog box.</li> <li>• <b>Manage CI Watchpoints.</b> Enables you to add new watchpoints to the CI or remove existing ones. For details, see Manage CI Watchpoints dialog box.</li> </ul>
	<p><b>CI Collection.</b> Enables you to group CIs in a collection under a model. Select one of the following options:</p> <ul style="list-style-type: none"> <li>• <b>Insert New CI Collection.</b> Create a new empty CI Collection. After creating the collection, you can drag CIs into it from the CI Selector, the related CIs tab, or from the model itself.</li> <li>• <b>Join to CI Collection.</b> Select a CI or several CIs in the model and join them to an existing CI collection or form a new collection.</li> <li>• <b>Decompose CI Collection.</b> Select a CI collection and decompose it. Its CIs remain directly under the main model.</li> </ul>
	<p><b>Find.</b> Toggles between displaying and hiding the Find box and arrow controls.</p> <p><b>Note:</b> This button only appears in Text mode.</p>
	<p><b>Refresh.</b> Refreshes the map to optimize the layout.</p>

UI Element (A-Z)	Description
	<p><b>Note:</b> This button only appears in Map mode.</p>
	<p><b>Fit to Window.</b> Resizes the map to fit the size of the pane.</p> <p><b>Note:</b> This button only appears in Map mode.</p>
	<p>Select the functionality of the cursor from the <b>Mode</b> drop-down. The following options are available:</p> <ul style="list-style-type: none"> <li>• Select</li> <li>• Drag Map</li> <li>• Zoom In</li> </ul> <p><b>Note:</b> This feature only appears in Map mode.</p>
	<p><b>Print.</b> Enables you to select Print, Print Preview or Print Setup.</p>
	<p><b>Show External Relationships.</b> Displays the related CIs for the selected CI.</p> <p><b>Note:</b> This button only appears in Map mode.</p>
	<p><b>Hide External Relationships.</b> Hides the related CIs of the selected CI.</p> <p><b>Note:</b> This button only appears in Map mode.</p>
	<p>Indicates that watchpoints are defined for the current CI.</p>
	<p>Indicates that the watchpoints have detected new CIs related to the current model. Click it to open the Watchpoints Updates dialog box.</p>
<p><b>CI Type column</b></p>	<p>Displays the type of each CI in the model.</p>
<p><b>Find</b></p>	<p>Enter a CI name or a portion of a CI name in the Find box to locate a CI in the model.</p>
<p><b>Find Next</b></p>	<p>Click to go to the next occurrence of the selected search phrase in the model.</p>

UI Element (A-Z)	Description
<b>Find Previous</b>	Click to go to the previous occurrence of the selected search phrase in the model.
<b>Highlight</b>	Click to highlight all occurrences of the search phrase in the model.
<b>Name column</b>	Displays the name of each CI in the model.

**Shortcut Menu Options**

Menu Item	Description
<b>CI Collection</b>	<p>Click <b>CI Collection</b> to group CIs in a collection under a model. Select one of the following options:</p> <ul style="list-style-type: none"> <li>• <b>Insert New CI Collection.</b> Create a new empty collection. After creating the collection, you can drag CIs into it from the CI Selector, the related CIs tab, or from the model itself.</li> <li>• <b>Join to CI Collection.</b> Select a CI or several CIs in the model and join them to an existing CI collection or form a new group.</li> <li>• <b>Decompose CI Collection.</b> Select a CI collection and decompose it. Its CIs remain directly under the main model.</li> </ul>
<b>Fit to Window</b>	<p>Resizes the map to fit the size of the pane.</p> <p><b>Note:</b> This option only appears in Map mode.</p>
<b>Generate view for selected model</b>	Creates a view based on the current model. The Creating New View dialog box opens which enables you to select a perspective to apply.
<b>Hide External Relationships</b>	<p>Hides the related CIs from the map.</p> <p><b>Note:</b> This option only appears in Map mode.</p>
<b>Insert New Model</b>	Opens the New Model dialog box which enables you to create a new model within the existing model.
<b>Open selected model in a new tab</b>	Opens the selected model in a separate Model Editor tab.
<b>Print</b>	Select one of the following options:

Menu Item	Description
	<ul style="list-style-type: none"> <li>• Print</li> <li>• Print Preview</li> <li>• Print Setup</li> </ul>
<b>Properties</b>	Opens the Configuration Item Properties dialog box for the selected CI.
<b>Refresh Layout</b>	Refreshes the map and optimizes the map layout.  <div style="background-color: #f0f0f0; padding: 5px;"><b>Note:</b> This option only appears in Map mode.</div>
<b>Remove Selected CI(s) from the Model</b>	Deletes the selected CIs from the model (it remains in the CMDB).
<b>Reveal</b>	The following options are available: <ul style="list-style-type: none"> <li>• <b>Start Revealing.</b> Opens the Reveal CIs dialog box. For details, see Reveal CIs dialog box.</li> <li>• <b>Open Reveal Path.</b> Opens the Open Reveal Path dialog box. For details, see Open Reveal Path dialog box.</li> </ul>
<b>Select</b>	Select the functionality of the cursor. The following options are available: <ul style="list-style-type: none"> <li>• Select</li> <li>• Drap Map</li> <li>• Zoom In</li> </ul> <div style="background-color: #f0f0f0; padding: 5px;"><b>Note:</b> This option only appears in Map mode.</div>
<b>Show Containing Models</b>	Displays a list of the models containing the selected CI.
<b>Show Containing Views</b>	Displays a list of the views containing the selected CI or model.
<b>Show External Relationships</b>	Displays the related CIs for the selected CI.  <div style="background-color: #f0f0f0; padding: 5px;"><b>Note:</b> This option only appears in Map mode.</div>

Menu Item	Description
<b>Watchpoint</b>	The following options are available: <ul style="list-style-type: none"> <li>• <b>Watchpoints Updates.</b> Display the watchpoint results and select CIs to add to the model. For details, see Watchpoints Updates dialog box.</li> <li>• <b>New Watchpoint.</b> Define a new watchpoint for the selected CI. For details, see New Watchpoint dialog box.</li> <li>• <b>Manage CI Watchpoints.</b> Add new watchpoints to the CI or remove existing ones. For details, see Manage CI Watchpoints dialog box.</li> </ul>
<b>Zoom</b>	Select the size of the map from the list of percents. <div style="background-color: #f0f0f0; padding: 5px; margin-top: 10px;"> <b>Note:</b> This option only appears in Map mode.                     </div>

### Information Pane - Properties Tab



This area displays the properties of the selected CI.

<b>Important information</b>	This pane is identical to the Properties tab of the Information pane in IT Universe Manager. For details, see <a href="#">"Configuration Item Properties Dialog Box" on page 220.</a>
------------------------------	---

### Information Pane - Related CIs Tab

This area displays the CIs related to the model by one of the triplets that includes an Impacted By (Potentially) relationship.

User interface elements are described below (unlabeled elements are shown in angle brackets):

UI Element (A-Z)	Description
	Click to delete the relationship to the selected CI.
	Click <b>Invert Direction</b> to switch the direction of the relationship for the selected CI. <div style="background-color: #f0f0f0; padding: 5px; margin-top: 10px;"> <b>Note:</b> This option is only active for CIs related by a <b>usage</b> relationship.                     </div>
<CI list>	Lists the name and CI type of the CIs related to the model by usage relationships, as well as the direction of the relationship.

UI Element (A-Z)	Description
<b>Filter by</b>	Select a field by which to filter the results and enter the value in the <b>by</b> box.

### Information Pane - Watchpoints Tab

This area displays the watchpoints defined for the selected CI.

User interface elements are described below:

UI Element (A-Z)	Description
	Click to open the Manage CI Watchpoints dialog box, which enables you to edit the watchpoint.
<b>Automated</b>	Indicates whether the new CIs found by the watchpoint are automatically added to the view.
<b>Source CI</b>	Displays the CI forming the beginning of the reveal path.
<b>Watchpoint Name</b>	The name of the reveal path associated with the watchpoint.
<b>Watchpoint Path</b>	Displays the reveal path of the watchpoint.

## Modeling Studio Page

This page enables you to create and edit models and views.





<b>To access</b>	Select <b>Modeling Studio</b> from the Navigation Menu or select <b>Managers &gt; Modeling &gt; Modeling Studio</b> .
<b>Important information</b>	<p>The Modeling Studio page contains the following panes:</p> <ul style="list-style-type: none"> <li>• <b>Left pane.</b> Enables you to search for CIs or select a view, model, or TQL query to open. For details, see "<a href="#">Left Pane</a>" on page 297.</li> <li>• <b>Editor pane.</b> Displays the topology map of a selected view, model, or TQL query.</li> </ul> <p>The Editor pane is a blank canvas before any views or models are opened. When you open a view, model, or TQL query, the relevant editor appears there. Multiple views, models, and queries can be open at the same time in the Editor pane, each within a separate tab.</p>

<p><b>Relevant tasks</b></p>	<ul style="list-style-type: none"> <li>• <a href="#">"How to Create a Pattern View" on page 271</a></li> <li>• <a href="#">"How to Create a Template" on page 273</a></li> <li>• <a href="#">"How to Create a Perspective" on page 274</a></li> <li>• <a href="#">"How to Create a Dynamic Widget" on page 276</a></li> <li>• <a href="#">"How to Create a Template Based View" on page 278</a></li> <li>• <a href="#">"How to Create Multiple Template Based Views" on page 280</a></li> <li>• <a href="#">"How to Build an Instance-based Model " on page 283</a></li> <li>• <a href="#">"How to Build a New Pattern-based Model " on page 284</a></li> <li>• <a href="#">"How to Define Report Settings" on page 281</a></li> <li>• <a href="#">"How to Build a Perspective-based View Based on a Collection of CIs" on page 286</a></li> <li>• <a href="#">"How to Build a Perspective-based View Based on a Model " on page 285</a></li> </ul>
<p><b>See also</b></p>	<ul style="list-style-type: none"> <li>• <a href="#">"Building a Perspective-based View" on page 264</a></li> <li>• <a href="#">"Business CI Models" on page 262</a></li> <li>• <a href="#">"Creating Template Based Views" on page 261</a></li> <li>• <a href="#">"Templates and Perspectives" on page 259</a></li> <li>• <a href="#">"View Formats" on page 255</a></li> <li>• <a href="#">"Modeling Studio User Interface" on page 287</a></li> </ul>

User interface elements are described below (unlabeled elements are shown in angle brackets>):

<p><b>UI Element (A-Z)</b></p>	<p><b>Description</b></p>
<p> <b>New</b></p>	<p><b>New.</b> Select one of the following options:</p> <ul style="list-style-type: none"> <li>• <b>Instance Based Model.</b> To create a new instance based model.</li> <li>• <b>Pattern Based Model.</b> To create a new pattern based model.</li> <li>• <b>Pattern View.</b> To create a new pattern view.</li> </ul>





UI Element (A-Z)	Description
	<ul style="list-style-type: none"> <li>• <b>Template Based View.</b> To create a new template-based view.</li> <li>• <b>Perspective Based View.</b> To create a new perspective-based view.</li> <li>• <b>Template.</b> To create a new template.</li> <li>• <b>Perspective.</b> To create a new perspective.</li> <li>• <b>Dynamic Widget.</b> To create a new dynamic widget for the UCMDB Browser.</li> <li>• <b>Query.</b> To create a new TQL query.</li> <li>• <b>Automation Flow Mapping.</b> To create an automation flow mapping. Only relevant when the Automation Flow Adapter has been deployed. For details, see the UCMDB Browser documentation.</li> </ul>
	<p><b>Save.</b> Saves the changes to your view, model, or query.</p> <p>For views, a dialog box opens which enables you to rename your view and save it in the appropriate folder.</p>
	<p><b>Save As.</b> Enables you to save your view, model, or TQL query under a new name.</p>
	<p><b>Undo.</b> Reverses the last change you made.</p>
	<p><b>Redo.</b> Repeats the last action you took.</p>
	<p><b>Maximize Workspace.</b> Toggles between the regular display and a full-screen display of the editor.</p>
<p>&lt;Menu&gt;</p>	<p>For details, see <a href="#">"Main Menu" on page 164.</a></p>

## Models Containing Selected CI Dialog Box

This dialog box enables you to display a list of the models containing the selected CI.

<p><b>To access</b></p>	<p>Click the <b>Show models containing selected CI</b>  button in the Model Editor or select <b>Show containing models</b> from the shortcut menu.</p>
<p><b>See also</b></p>	<ul style="list-style-type: none"> <li>• <a href="#">"Business CI Models" on page 262</a></li> <li>• <a href="#">"Modeling Studio User Interface" on page 287</a></li> </ul>

User interface elements are described below:

UI Element (A-Z)	Description
	<b>CI Properties.</b> Opens the Configuration Item Properties dialog box for the selected model.
	<b>Show views containing selected CI/model.</b> Displays a list of views containing the selected model.
	<b>Remove model.</b> Deletes the selected model.
<b>CI Type</b>	Displays the CI types of the models containing the selected CI.
<b>Find</b>	Enter a model name or a portion of a model name in the Find box to locate it in the list.
<b>Find Next</b>	Click to go to the next occurrence of the selected search phrase in the list.
<b>Find Previous</b>	Click to go to the previous occurrence of the selected search phrase in the list.
<b>Name</b>	Displays the names of the models containing the selected CI.  <b>Note:</b> The name of the current model appears in faded text.

## New Model Dialog Box

This dialog box enables you to define a reusable model containing a collection of CIs.

<b>To access</b>	Click the <b>New</b>  button and select <b>Instance Based Model</b> or drag a CI from the tree in the CI Selector onto the editing pane and select <b>Create a new model</b> .
<b>Relevant tasks</b>	<a href="#">"How to Build an Instance-based Model " on page 283</a>
<b>See also</b>	<ul style="list-style-type: none"> <li>• <a href="#">"Business CI Models" on page 262</a></li> <li>• <a href="#">"Modeling Studio User Interface" on page 287</a></li> </ul>

User interface elements are described below:



UI Element (A-Z)	Description
<b>Define new CI Properties</b>	Enter the values for the CI properties. You must enter values for required properties. The required properties are marked with an asterisk.
<b>Select CI Type</b>	Select a CI type from the list to serve as the basis for your model.

## New Pattern View/Template/Perspective Dialog Box

This dialog box enables you to define a new pattern view, template, or perspective using the Pattern View Editor.

<b>To access</b>	In the Modeling Studio, click the <b>New</b>  button and select <b>Pattern View, Template, or Perspective</b> from the drop-down menu.
<b>Important information</b>	After making your selection and clicking <b>OK</b> , you go directly to the Pattern View Editor to begin building your view. For details, see <a href="#">"Pattern View Editor" on page 321</a> .
<b>Relevant tasks</b>	<a href="#">"How to Create a Pattern View" on page 271</a> , <a href="#">"How to Create a Template" on page 273</a> , <a href="#">"How to Create a Perspective" on page 274</a>
<b>See also</b>	<ul style="list-style-type: none"> <li>• <a href="#">"Building a Business View" on page 255</a></li> <li>• <a href="#">"Modeling Studio User Interface" on page 287</a></li> </ul>

User interface elements are described below (unlabeled elements are shown in angle brackets):

UI Element (A-Z)	Description
	<b>Find Next.</b> Goes to the next occurrence of the selected search phrase in the list of TQL queries.
	<b>Find Previous.</b> Goes to the previous occurrence of the selected search phrase in the list of TQL queries.
	<b>Highlight All.</b> Highlights all occurrences of the search phrase in the list of TQL queries.
<b>&lt;TQL query tree&gt;</b>	Displays the existing TQL queries in tree format.
<b>Choose base</b>	If you want to base your new view on an existing TQL query, select this option and select a TQL query from the tree. The Pattern View Editor opens with the selected TQL query on the

UI Element (A-Z)	Description
<b>query</b>	canvas.
<b>Create new query</b>	If you want to base your new view on a new TQL query, select this option. The Pattern View Editor opens with a blank canvas.
<b>Find</b>	Enter a TQL query name or a portion of a query name in the Find box to locate a TQL query in the list.

## New Watchpoint Dialog Box

This dialog box enables you to define a watchpoint for a CI in a model.

<b>To access</b>	From within a model in the Model Editor, click the <b>Watchpoint</b>  button and select <b>New Watchpoint</b> or right-click a CI in the model and select <b>Watchpoint &gt; New Watchpoint</b> .
<b>Important information</b>	If no reveal paths are found for the selected CI, no watchpoints can be defined. You cannot define watchpoints for CIs in a new model until you save the model.
<b>Relevant tasks</b>	<a href="#">"How to Build an Instance-based Model " on page 283</a>
<b>See also</b>	<ul style="list-style-type: none"> <li>• <a href="#">"Revealed CIs and Watchpoints" on page 267</a></li> <li>• <a href="#">"Modeling Studio User Interface" on page 287</a></li> </ul>

User interface elements are described below:

UI Element (A-Z)	Description
<b>Automatically update model</b>	Select to automatically add all revealed CIs from the selected path to the model.  <b>Note:</b> In a multi-tenancy environment, this action requires Data Update permission in connection with all tenants of the model.
<b>Control updates manually</b>	Select to manually add revealed CIs from the selected path to the model.
<b>Select Watchpoint</b>	Select a reveal path from the drop-down list.

UI Element (A-Z)	Description
<b>reveal path</b>	
<b>Show reveal paths for CI type</b>	Select a CI type from the drop-down list. All reveal paths beginning with that CI type appear in the list in the lower drop-down box.

## Open Reveal Path Dialog Box

This dialog box enables you to open an existing path.

<b>To access</b>	From within a model in the Model Editor, click the <b>Reveal</b>  button and select <b>Open Reveal Path</b> or right-click a CI in the model and select <b>Reveal &gt; Open Reveal Path</b> .
<b>Important information</b>	After selecting the reveal path you want to use, click <b>Execute</b> . If CIs are found on the selected path, the Reveal CIs dialog box opens for that path. If no CIs are found, a message appears stating that no CIs were found on the path.
<b>See also</b>	<ul style="list-style-type: none"> <li>• <a href="#">"Revealed CIs and Watchpoints" on page 267</a></li> <li>• <a href="#">"Modeling Studio User Interface" on page 287</a></li> </ul>

User interface elements are described below:

UI Element (A-Z)	Description
<b>Description column</b>	Displays the descriptions of the existing paths.
<b>Edit</b>	Opens the Edit Reveal Path dialog box which enables you to edit the selected path.
<b>Execute</b>	Opens the Reveal CIs dialog box for the selected reveal path.
<b>Find</b>	Enter a path name or a portion of a path name in the Find box to locate a path in the list.
<b>Find Next</b>	Click to go to the next occurrence of the selected search phrase in the list of paths.
<b>Find Previous</b>	Click to go to the previous occurrence of the selected search phrase in the list of paths.
<b>Highlight</b>	Click to highlight all occurrences of the search phrase in the list of paths.
<b>Name column</b>	Displays the names of the existing paths.

UI Element (A-Z)	Description
<b>Remove</b>	Deletes the selected path.
<b>Show reveal paths for CI type</b>	Select a CI type from the drop-down list. All paths beginning with the selected CI appear in the table below.

## Pattern Based Model Scheduler Dialog Box

This dialog box enables you to set the starting date and time and the repeat interval for Pattern-based models.

<b>To access</b>	In the Modeling Studio, click the <b>Pattern Based Model Scheduler</b>  button in the Resources tab of the left pane.
<b>Important information</b>	All the pattern-based models are updated at the same time. The settings you select apply to all existing pattern-based models as well as those created subsequently. The default starting time for model updates is the server time at the time the first model is created. When you open the dialog box, the default starting time is the current server time at that moment. The default repeat interval is 12-hours.
<b>Relevant tasks</b>	<a href="#">"How to Build a New Pattern-based Model " on page 284</a>
<b>See also</b>	<ul style="list-style-type: none"> <li>• <a href="#">"Business CI Models" on page 262</a></li> <li>• <a href="#">"Modeling Studio User Interface" on page 287</a></li> </ul>

User interface elements are described below (unlabeled elements are shown in angle brackets>):

UI Element (A-Z)	Description
<b>Advanced Pattern Based Model Scheduler Updates</b>	Select this option to schedule the pattern-based model updates using a Cron expression.
<b>Cron Expression</b>	<p>When <b>Advanced Pattern Based Model Scheduler Updates</b> is selected, enter a Cron expression.</p> <p>For a description of the fields used in Cron expressions and examples of how to use them, see <a href="#">"Cron Expressions" on page 362</a>.</p>
<b>Daily Pattern Based Model Scheduler Updates</b>	Select this option to schedule the pattern-based model updates using a starting date and time and a repeat interval.
<b>Repeat interval</b>	When <b>Daily Pattern Based Model Scheduler Updates</b> is

UI Element (A-Z)	Description
	selected, select an option for the repeat interval (in hours). This determines the frequency of the pattern-based model updates. <div style="background-color: #f0f0f0; padding: 5px; margin-top: 10px;"> <b>Note:</b> The repeat interval must be evenly divisible in a 24-hour period to ensure that the updates are performed at the same hours each day.                     </div>
<b>Server time</b>	Displays the time on the server.
<b>Start at</b>	Select a starting date and time for the pattern-based model updates.
<b>Validate Expression</b>	After entering a Cron expression, click the <b>Validate Expression</b> button to confirm that the expression is valid.

## Pattern Based Model Wizard

This wizard enables you to build a pattern-based model.

<b>To access</b>	In the Modeling Studio, click the <b>New</b>  button and select <b>Pattern Based Model</b> from the drop-down menu.
<b>Important information</b>	<p>When you create a pattern-based model, the model is saved as a CI, as with an instance-based model. If you based your model on a new TQL query, the query is also saved and appears in the TQL query tree.</p> <p>When you build a pattern-based model over an existing instance-based model, the model is saved with the name of the instance-based model.</p> <p>If you create a new pattern-based model with the same name as a previously deleted pattern-based model, you can select an old query on which to base the new pattern-based model or you can create a new query.</p>
<b>Relevant tasks</b>	<a href="#">"How to Build a New Pattern-based Model " on page 284</a>
<b>Wizard map</b>	The Pattern Based Model Wizard contains:  <a href="#">"Select CI Type Page"</a> > <a href="#">"Query Selection Page"</a>
<b>See also</b>	<ul style="list-style-type: none"> <li>• <a href="#">"Pattern-based Models" on page 263</a></li> <li>• <a href="#">"Modeling Studio User Interface" on page 287</a></li> </ul>

## Select CI Type Page

This wizard page enables you to select a CI type for the model and define its details.

<b>Wizard map</b>	The Pattern Based Model Wizard contains:  <a href="#">"Select CI Type Page"</a> > <a href="#">"Query Selection Page"</a>
-------------------	--

User interface elements are described below:



<b>UI Element (A-Z)</b>	<b>Description</b>
<b>Existing Model</b>	Select <b>Existing Model</b> to build a pattern-based model over an existing instance-based model. Select an existing model from the tree.
<b>New Model</b>	Select <b>New Model</b> to create a new pattern-based model (unrelated to any other model). In the <b>Select CI Type</b> section, select a CI type from the list to serve as the basis for your model. Then enter the values for the CI properties in the <b>Define New CI Properties</b> section.

## Query Selection Page

This wizard page enables you to select a TQL query upon which the model is based.

<b>Wizard map</b>	The Pattern Based Model Wizard contains:  <a href="#">"Select CI Type Page"</a> > <a href="#">"Query Selection Page"</a>
-------------------	--

User interface elements are described below (unlabeled elements are shown in angle brackets>):

<b>UI Element (A-Z)</b>	<b>Description</b>
	<b>Find Next.</b> Goes to the next occurrence of the selected search phrase in the list of TQL queries.
	<b>Find Previous.</b> Goes to the previous occurrence of the selected search phrase in the list of TQL queries.
	<b>Highlight All.</b> Highlights all occurrences of the search phrase in the list of TQL queries.



UI Element (A-Z)	Description
<TQL Query tree>	Displays the existing TQL queries in tree format.
Choose base query	If you want to base your model on an existing TQL query, select this option and select a query from the tree. The TQL Query Editor opens with the selected query on the canvas.
Create new query	If you want to base your model on a new TQL query, select this option. The TQL Query Editor opens with a blank canvas. <div style="background-color: #f0f0f0; padding: 5px; margin-top: 10px;"> <b>Note:</b> When you create a pattern-based model based on a new query, the query's priority is automatically set to <b>Not Active</b>.                     </div>
Find	Enter a TQL query name or a portion of a query name in the Find box to locate a query in the list.

## Pattern View Editor









This feature enables you to build and edit pattern views, templates, and perspectives.

<b>To access</b>	To open a new view in the Pattern View Editor, go to the Modeling Studio, click the <b>New</b>  button and select the required type of view.  To open an existing view in the Pattern View Editor, go to the Resources tab of the left pane in the Modeling Studio and select <b>Views</b> as the Resource type. Right-click a view in the tree and select <b>Open View</b> or double click a view or drag a view onto the Editor pane. The topology map of the view opens in the Editor pane.
<b>Important information</b>	You can access the Editor in one of the following modes: <ul style="list-style-type: none"> <li>• In <b>View</b> mode, the following panes are included:                             <ul style="list-style-type: none"> <li>◦ <b>Query Definition pane.</b> For details, see <a href="#">"TQL Query Editor" on page 348</a>.</li> <li>◦ <b>Advanced pane.</b> For details, see <a href="#">"Advanced Pane" on page 1</a>.</li> <li>◦ <b>Hierarchy pane.</b> Enables you to set the hierarchy of the view. (Located in the right portion of the Editor page.)</li> </ul> </li> <li>• In <b>Report</b> mode, the following panes are included:</li> </ul>

	<ul style="list-style-type: none"> <li>○ <b>Hierarchy pane.</b> Enables you to set the hierarchy of the view. (Located in the left portion of the Editor page.)</li> <li>○ <b>Query Node Definition.</b> Enables you to select the attributes to be included in the report and to set their order.</li> <li>● In <b>Widget</b> mode, the following panes are included:             <ul style="list-style-type: none"> <li>○ <b>Hierarchy pane.</b> Enables you to set the hierarchy of the view. (Located in the left portion of the Editor page.)</li> <li>○ <b>Widget Node Definition.</b> Enables you to specify options for the CI's attributes to be included in the dynamic widget.</li> </ul> </li> </ul> <div style="background-color: #f0f0f0; padding: 5px; margin-top: 10px;"> <p><b>Note:</b> Widget mode is available only when creating or editing a dynamic widget.</p> </div> <div style="background-color: #f0f0f0; padding: 5px; margin-top: 10px;"> <p><b>Note:</b> To save your view, template, perspective, or dynamic widget, use the <b>Save</b> button on the Modeling Studio main toolbar.</p> </div>
<p><b>Relevant tasks</b></p>	<ul style="list-style-type: none"> <li>● <a href="#">"How to Create a Pattern View" on page 271</a></li> <li>● <a href="#">"How to Create a Template" on page 273</a></li> <li>● <a href="#">"How to Create a Perspective" on page 274</a></li> <li>● <a href="#">"How to Create a Dynamic Widget" on page 276</a></li> </ul>
<p><b>See also</b></p>	<ul style="list-style-type: none"> <li>● <a href="#">"Building a Perspective-based View" on page 264</a></li> <li>● <a href="#">"Templates and Perspectives" on page 259</a></li> <li>● <a href="#">"Modeling Studio User Interface" on page 287</a></li> </ul>

## Hierarchy Pane

User interface elements are described below (unlabeled elements are shown in angle brackets>):

UI Element (A-Z)	Description
	<p><b>Add Group By.</b> Enables you to create a subgroup in the hierarchy. The following options are available:</p> <ul style="list-style-type: none"> <li>• <b>Add Group By Attribute.</b> Opens the Query Node Grouping dialog box, which enables you to select an attribute for a subgroup in the hierarchy.</li> <li>• <b>Add Group By CI Type.</b> Create a subgroup in the hierarchy for the CI type of the selected query node.</li> <li>• <b>Add Group by View Node.</b> Create a subgroup in the hierarchy for the selected query node only.</li> </ul> <p><b>Note:</b> You cannot define subgroups on a contact query node of a perspective.</p>
	<p><b>Edit Group By Attribute.</b> Opens the Query Node Grouping dialog box, which enables you to edit the attribute for a subgroup in the hierarchy.</p>
	<p><b>Rename.</b> Enables you to rename the selected query node.</p>
	<p><b>Delete View Node</b> Deletes the selected query node from the hierarchy tree.</p>
	<p><b>Move View Node Layer Up.</b> Moves the selected query node one layer higher in the hierarchy.</p>
	<p><b>Move View Node Layer Down.</b> Moves the selected query node under the query node above it in the hierarchy.</p> <p><b>Note:</b> If the selected query node is located at the top of the hierarchy tree, clicking <b>Move View Node Layer Down</b> places it under the query node beneath it in the hierarchy.</p>
	<p><b>Move View Node Up.</b> Moves the selected query node up in the hierarchy tree. The query node order in the hierarchy determines the query node order in the report generated for the view in Reports.</p>
	<p><b>Move View Node Down.</b> Moves the selected query node down in the hierarchy tree. The query node order in the hierarchy determines the query node order in the report generated for the view in Reports.</p>
	<p><b>Preview.</b> Displays a preview of the topology report.</p>

UI Element (A-Z)	Description
	<p><b>Note:</b> This option only appears in the Hierarchy pane when Report mode is selected.</p>
	<p><b>Report Properties.</b> Opens the Report Properties dialog box, which enables you to set the title, subtitle, and format for the view's topology report. For details, see <a href="#">"Report Properties Dialog Box" on page 434</a>.</p>
<p>&lt;Hierarchy tree&gt;</p>	<p>The query nodes of the TQL query are arranged in a hierarchical tree reflecting the hierarchy defined for the view.</p> <p>You can click and drag query nodes to change the hierarchy. When you click a query node and begin to drag it, the query nodes under which it is possible to place your query node are highlighted in green.</p>
<p><b>Hierarchy Method</b></p>	<p>Select the method of setting the hierarchy:</p> <ul style="list-style-type: none"> <li>• <b>Manual.</b> Set the hierarchy manually, by dragging query nodes and using the toolbar buttons.</li> <li>• <b>Rule Based.</b> Open the Hierarchy Rules dialog box which enables you to set rules for the hierarchy.</li> </ul>

**Shortcut Menu**

The Hierarchy pane includes the following elements (listed alphabetically) available by right-clicking a query node in the hierarchy tree:





Menu Item	Description
<p><b>Add Group By Attribute</b></p>	<p>Select <b>Add Group By Attribute</b> to open the Query Node Grouping dialog box, which enables you to select an attribute for a subgroup in the hierarchy.</p>
<p><b>Add Group By CI Type</b></p>	<p>Select <b>Add Group By CI Type</b> to create a subgroup in the hierarchy for the CI type of the selected query node.</p>
<p><b>Add Group By View Node</b></p>	<p>Select <b>Add Group By View Node</b> to create a subgroup in the hierarchy for the selected query node only.</p>
<p><b>Define Cycles</b></p>	<p>Select <b>Define Cycles</b> to define a cyclical hierarchy. For details, see <a href="#">"Cycle Definition Dialog Box" on page 295</a>.</p>

Menu Item	Description
<b>Delete View Node</b>	Select to delete the selected query node from the hierarchy tree.
<b>Move View Node Down</b>	Select to move the selected query node down in the hierarchy tree.
<b>Move View Node Layer Down</b>	<p>Select <b>Move View Node Layer Down</b> to place the selected query node under the query node above it in the hierarchy.</p> <p><b>Note:</b> If the selected query node is located at the top of the hierarchy tree, selecting <b>Move View Node Layer Down</b> places it under the query node beneath it in the hierarchy</p>
<b>Move View Node Layer Up</b>	Select <b>Move View Node Layer Up</b> to place the selected query node one layer higher in the hierarchy.
<b>Move View Node Up</b>	Select to move the selected query node up in the hierarchy tree.
<b>Rename</b>	Select to rename the selected query node.
<b>Set View Node Invisible</b>	<p>Select to set the selected query node invisible. CIs of this type do not appear in the view results.</p> <p>When this option is selected, a <b>Hidden in Query Results</b> indicator  appears in the corner of the selected query node in the hierarchy tree.</p>
<b>Set View Node Visible</b>	Select to set the selected query node visible. CIs of this type appear in the view results.
<b>Subgraph Hierarchy</b>	<p>Enables you to define whether the subgraph defined for the selected query node is displayed as flat or as folded under the query node.</p> <p><b>Note:</b> This option is only relevant for query nodes that have a defined subgraph.</p>

### Query Node Definition Pane

<b>Important information</b>	The Query Node Definition pane is disabled for template based views. To make changes to the report layout, edit the based template of the view. When you open a template based view in the Editor and select the Report tab, a warning message appears containing a link to the base template of the view.
------------------------------	--

User interface elements are described below:

<b>UI Element (A-Z)</b>	<b>Description</b>
	<b>Up.</b> Moves a selected attribute up in the report layout order.
	<b>Down.</b> Moves a selected attribute down in the report layout order.
	<b>Edit.</b> Enables you to edit the function for the selected attribute.
	<b>Delete.</b> Deletes the selected attribute from the report layout.
	Moves the selected attributes to the Report Layout list.
<b>Add Function</b>	<p>Click <b>Add Function</b> to open the Add Function dialog box, which enables you to define the functions to include in the report for the selected query node. Each function that you add is treated as an attribute and becomes a column in the report.</p> <div style="background-color: #f0f0f0; padding: 5px; margin-top: 10px;"> <p><b>Note:</b> This button is only active if there is a query node below the selected query node in the view hierarchy.</p> </div>
<b>Attributes</b>	The list of available attributes for the selected query node.
<b>Define Chart</b>	<p>Click <b>Define Chart</b> to display the data for the current layer of the view in a graphical chart format. The Chart Properties fields are displayed.</p> <p>The Define Chart option is only active for a query node or a grouping node that:</p> <ul style="list-style-type: none"> <li>• is the top layer of the view and has a layer below it in the view hierarchy</li> <li>• is the only query node on its layer of the view</li> <li>• has at least one numeric attribute selected for the report layout</li> </ul>
<b>Report Layout</b>	Displays the list of attributes selected to appear in the report. Use the toolbar buttons to change the order of the attributes in the report and to add functions.
<b>Set Sort Order</b>	Click to open the Set Column Sort Order dialog box which enables you to set the order of the report columns.

### Chart Properties

The Chart Properties portion of the pane includes the following elements (listed alphabetically):

UI Element (A-Z)	Description
	<b>Remove Chart.</b> Removes the chart from the report. The report is generated in table format.
<b>Breakdown by</b>	The chart is broken down by the CI or grouping node display label. This is fixed for all reports.
<b>Chart Type</b>	Select <b>Pie</b> to create a pie chart or <b>Bar</b> to create a bar chart.
<b>Value</b>	Select a value from the drop-down list.

### Widget Definition Pane



User interface elements are described below:

UI Element (A-Z)	Description
<b>&lt;Enforce Browser CI access control&gt;</b>	Select this check box to ensure that the dynamic widget displays data only according to the permissions that were specified on the Browser CI Access Control tab in the Roles manager. If the check box is not selected, the dynamic widget displays all data, without permission enforcement.
<b>&lt;Show path&gt;</b>	Select this check box to cause the UCMDB Browser to display the route in the dynamic widget from a specific node in the view definition to all the node's children.
<b>Attribute name</b>	The attributes for the selected node that are displayed in the dynamic widget.
<b>Details</b>	Specifies whether this attribute appears in the Widget Details mode.
<b>Group Name</b>	Specifies the name under which the attribute is grouped in the Widget Details mode.
<b>Overview</b>	Specifies whether this attribute appears in the CI Overview mode.
<b>Refocusable</b>	Specifies whether this attribute is displayed as a hyperlink, able to refocus on the CI on which the attribute is defined.
<b>Widget Type</b>	Enables you to select an initial display mode. The available types are: <ul style="list-style-type: none"> <li><b>Properties Mode.</b> Displays individual properties for CIs.</li> </ul> <div style="background-color: #f0f0f0; padding: 5px; margin-top: 10px;"> <p><b>Note:</b> If you do not select a Widget Type value, Properties Mode is enabled by default.</p> </div>

UI Element (A-Z)	Description
	<ul style="list-style-type: none"> <li>• <b>Topology Map Mode.</b> Displays CIs according to your current topology.</li> <li>• <b>Topology CIT Group Mode.</b> Displays CIs grouped by CI type according to your current model.</li> <li>• <b>Topology Textual Mode.</b> Displays a list of CIs broken down by CI type.</li> </ul> <p>The topology mode that you select is the initial view selection until you change to another one in the UCMDB Browser.</p>

## Perspective-based View Editor









This feature enables you to create and edit perspective-based views.

<p><b>To access</b></p>	<p>In the Modeling Studio, click the <b>New</b>  button and select <b>Perspective Based View</b> to create a new view or drag CIs from the CI Selector onto the blank canvas and select <b>Create a new view</b>.</p> <p>To open an existing view in the Editor, select Views as the resource type in the Resources pane, select the required perspective-based view from the tree, and click <b>Open View</b>  or double-click the view.</p>
<p><b>Important information</b></p>	<p>The Perspective-based View Editor contains the following panes:</p> <ul style="list-style-type: none"> <li>• <b>Content pane.</b> Drag CIs and/or models onto this pane to include them in your view.</li> <li>• <b>Perspective pane.</b> Select perspectives to apply to the content to build a view.</li> <li>• <b>View Results pane.</b> Displays a topology map with a preview of the current view. This pane includes most of the IT Universe Manager functionality.</li> </ul>
<p><b>Relevant tasks</b></p>	<ul style="list-style-type: none"> <li>• <a href="#">"How to Build a Perspective-based View Based on a Model " on page 285</a></li> <li>• <a href="#">"How to Build a Perspective-based View Based on a Collection of CIs" on page 286</a></li> </ul>
<p><b>See also</b></p>	<ul style="list-style-type: none"> <li>• <a href="#">"Building a Perspective-based View" on page 264</a></li> <li>• <a href="#">"Modeling Studio User Interface" on page 287</a></li> </ul>



## Content Pane

User interface elements are described below:

UI Element (A-Z)	Description
	<b>Show View Results in IT Universe.</b> Goes directly to the current view in IT Universe Manager.
	<b>Properties.</b> Opens the Configuration Item Properties dialog box for the selected CI.
	<b>Show models containing selected CI.</b> Displays a list of the models containing the selected CI.
	<b>Show views containing selected CI/model.</b> Displays a list of the views containing the selected CI or model.
	<b>Open selected model in a new tab.</b> Opens the selected model in a separate Model Editor tab.
	<b>Generate view for selected model.</b> Enables you to create a view based on the selected model. Opens the Creating New View dialog box where you can select a perspective to apply.
	<b>Remove Base CIs.</b> Removes the selected CI from the view content.
	<b>View Definition Properties.</b> Opens the View Definition Properties dialog box which enables you to set properties for the view.
	<b>Find.</b> Toggles between displaying and hiding the Find box and arrow controls.
<b>CI Type column</b>	Displays the type of each CI in the view.
<b>Find</b>	Enter a CI name or a portion of a CI name in the Find box to locate a CI in the view.
<b>Find Next</b>	Click to go to the next occurrence of the selected search phrase in the view.
<b>Find Previous</b>	Click to go to the previous occurrence of the selected search phrase in the view.
<b>Highlight</b>	Click to highlight all occurrences of the search phrase in the view.
<b>Name</b>	Displays the name of each CI in the view.





UI Element (A-Z)	Description
column	

### Shortcut Menu Options

Menu Item	Description
<b>Generate view for selected model</b>	Select to create a view based on the selected model. The Creating New View dialog box opens which enables you to select a perspective to apply.
<b>Open selected model in a new tab</b>	Opens the selected model in a separate Model Editor tab.
<b>Properties</b>	Opens the Configuration Item Properties dialog box for the selected CI.
<b>Remove Base CIs</b>	Deletes the selected CI or model from the view content.
<b>Show Containing Models</b>	Click to display a list of the models containing the selected CI.
<b>Show Containing Views</b>	Click to display a list of the views containing the selected CI or model.

### Perspective Pane

User interface elements are described below:









UI Element (A-Z)	Description
	<b>Remove perspective step.</b> Deletes the selected level of the perspective selection.
	<b>Move step up.</b> Shifts the perspective selection from the current level to the previous one.
	<b>Move step down.</b> Shifts the perspective selection from the current level to the following one.
	<b>Add perspective step.</b> Adds a new level to the perspective selection. The results of the previous perspective level serve as the input content for the new level.

UI Element (A-Z)	Description
	<p><b>Select perspectives.</b> Opens a dialog box with the available perspectives. Move the required perspectives from the available column to the selected column using the arrow buttons.</p> <p>To view a perspective definition, select a perspective in either column and click the <b>Open Definition</b> link. The perspective definition opens in a separate tab.</p>
<p><b>Apply Over Model Hierarchy</b></p>	<p>For views based on models, select the <b>Apply Over Model Hierarchy</b> check box to include the model hierarchy in the view and apply the perspectives to the CIs included in the model as well as to the model itself. Clear the check box to exclude the model hierarchy from the view and apply the perspectives to the model itself only. In this case, the model is treated as an ordinary CI.</p> <div style="background-color: #f0f0f0; padding: 5px; margin-top: 10px;"> <p><b>Note:</b> This option is disabled for a view based on a collection of CIs or on a model and a collection of CIs.</p> </div>
<p><b>Perspectives</b></p>	<p>Lists the selected perspectives.</p> <p>A default perspective appears in the window before any selection is made. You can set the value of the default perspective using the <b>Selected perspectives for new perspective based views</b> infrastructure setting.</p>

## View Results Pane

User interface elements are described below (unlabeled elements are shown in angle brackets>):

UI Element (A-Z)	Description
<p><b>Map</b></p>	<p>Displays the view results in Map mode.</p>
<p><b>Text</b></p>	<p>Displays the view results in Text mode.</p>
<p><b>Group by</b></p>	<p>Select a grouping method for the CIs in the topology map. The available options are:</p> <ul style="list-style-type: none"> <li>• <b>Group by Layer.</b> Group the CIs according to the value of the <b>layer</b> attribute of their CI type.</li> <li>• <b>Group by CI Type.</b> Group the CIs according to their CI type.</li> <li>• <b>Group by Classification.</b> Group the CIs according to the value of the</li> </ul>

UI Element (A-Z)	Description
	<p><b>classification</b> attribute of their CI type.</p> <ul style="list-style-type: none"> <li>• <b>No Grouping.</b> Do not group CIs.</li> </ul> <p><b>Note:</b></p> <ul style="list-style-type: none"> <li>• This option is available in Map mode only.</li> <li>• When a grouping option is selected, each group contains an indicator displaying the number of CIs in the group. If a group contains a large number of CIs, it opens in collapsed format, displaying only the name and count indicator. Click the + sign button to expand the group and display all the CIs. You can set the threshold of CIs for automatically collapsing the group by modifying the <b>Initially expand group max CIs threshold</b> setting in the Infrastructure Settings Manager.</li> </ul>
	<b>Create Relationship.</b> Creates a relationship between two CIs in the view.
	<b>Go Up One Layer.</b> Moves up one level in the topology map.
	<b>Drill Down One Layer.</b> Moves down one level in the topology map.
	<b>Delete from CMDB.</b> Deletes the selected CI from the CMDB.
	<b>Show CI Properties.</b> Opens the Configuration Item Properties dialog box for the selected CI.
	<b>Refresh.</b> Refreshes the view results.
	<p><b>Hide CI from View.</b> Hides the selected CI from the view. This option is only relevant for CIs that were added to the view via the perspective. You cannot hide CIs from the original view content from the view.</p> <p><b>Note:</b> Hidden CIs can be restored from the Hidden CIs dialog box.</p>
	<b>Show Hidden CIs.</b> Opens the Hidden CIs dialog box which enables you to restore CIs that were hidden from the view manually.
	<b>Create view based on selected CI/s.</b> Enables you to create a new view based on the CIs selected from the View Results pane.

UI Element (A-Z)	Description
	<b>Expand preview display.</b> Displays the preview in a separate pane.
<Breadcrumbs>	At the top of the topology map, the breadcrumbs indicate the relevant query nodes in each layer of the view for the path to the selected layer. The first item in the path is the <b>Top Layer</b> . When you select a CI from the layer below, the parent CI forms the next item in the breadcrumb path. You can click on any item in the path to display that layer in the topology map.
<Legend>	Indicates the icons displayed next to CIs with any of the following special statuses: <ul style="list-style-type: none"> <li>• <b>Added.</b> When Change Timeframe is active, indicates that the CI was added.</li> <li>• <b>Candidate for Deletion.</b> Indicates that the CI is a candidate for deletion.</li> <li>• <b>Changed.</b> When Change Timeframe is active, indicates that the CI was changed.</li> <li>• <b>Drill Down One Layer.</b> Indicates that there are CIs under the CI on a lower layer.</li> <li>• <b>External.</b> Indicates that the CI is a federated CI.</li> <li>• <b>Impacted.</b> When Impact Analysis is active, indicates an impacted CI.</li> <li>• <b>Impacted and Trigger.</b> When Impact Analysis is active, indicates a trigger CI that is impacted.</li> <li>• <b>Note.</b> Indicates that a note was added for the CI.</li> <li>• <b>Trigger.</b> When Impact Analysis is active, indicates a trigger CI.</li> </ul>
<Topology Map>	The topology map in the View Results pane follows the layout of the topology map in IT Universe Manager. For details, see <a href="#">"Topology Map" on page 231</a> .
<Topology Map Sidebar>	For details, see <a href="#">"Topology Map Sidebar" on page 176</a> .

**Shortcut Menu Options**

Menu Item	Description
<IT Universe Shortcut Menu	The IT Universe Manager shortcut menu options are available. For details, see <a href="#">"IT Universe Manager Page" on page 230</a> .

Menu Item	Description
<b>options&gt;</b>	
<b>Create view based on selected CI/s</b>	Select <b>Create view based on selected CI/s</b> to create a new view based on the CIs selected from the View Results pane.
<b>Hide CI from View</b>	Click to hide the selected CI from the view. This option is only relevant for CIs that were added to the view via the perspective. You cannot hide CIs from the original view content from the view. In the case of a view based on a model, the model cannot be hidden but its CIs can.
<b>Show Hidden CIs</b>	Restore hidden CIs to the view.

## Query Node Grouping Dialog Box

This dialog box enables you to define a new grouping of CIs or to edit an existing grouping.

<b>To access</b>	Click the <b>Add Group by</b>  button in the Hierarchy pane of the Pattern View Editor and select <b>Add Group by Attribute</b> or right-click the required query node and select <b>Add Group by Attribute</b> from the shortcut menu.
<b>Relevant tasks</b>	<a href="#">"How to Create a Pattern View" on page 271</a> , <a href="#">"How to Create a Template" on page 273</a> , <a href="#">"How to Create a Perspective" on page 274</a>
<b>See also</b>	<ul style="list-style-type: none"> <li>• <a href="#">"Building a Business View" on page 255</a></li> <li>• <a href="#">"Modeling Studio User Interface" on page 287</a></li> </ul>

User interface elements are described below:

UI Element (A-Z)	Description
<b>Expression capture group index</b>	Enter the number of the relevant portion of the regular expression. Enter <b>0</b> if the entire expression is relevant.
<b>Group by</b>	Select an attribute from the drop-down list.
<b>Mask to group by</b>	Enter a regular expression pattern representing the structure of the selected attribute.  For details, see <a href="#">"Query Node Grouping" on page 257</a> .

## Query/View Definition Properties Dialog Box

This dialog box enables you to configure the properties of a TQL query or view.

<b>To access</b>	In the Modeling Studio, click the <b>Query/View Definition Properties</b>  button in the TQL Query Editor or Pattern View Editor.
<b>Important information</b>	In the View Definition Properties dialog box, you can select a default layout for the view. Select an option under <b>Map Layout</b> or under <b>Group by</b> (only one option can be selected).
<b>Relevant tasks</b>	<ul style="list-style-type: none"> <li>• <a href="#">"How to Create a Pattern View" on page 271</a></li> <li>• <a href="#">"How to Create a Template" on page 273</a></li> <li>• <a href="#">"How to Create a Perspective" on page 274</a></li> <li>• <a href="#">"How to Define a TQL Query" on page 24</a></li> </ul>
<b>See also</b>	<ul style="list-style-type: none"> <li>• <a href="#">"Building a Business View" on page 255</a></li> <li>• <a href="#">"Modeling Studio User Interface" on page 287</a></li> </ul>

User interface elements are described below:

UI Element (A-Z)	Description
<b>Base Query</b>	<p>Select an existing TQL query on which to base your new query. Click <b>Clear Base Query</b>  to remove the selected base query.</p> <p><b>Note:</b></p> <ul style="list-style-type: none"> <li>• This field is only relevant for TQL queries.</li> <li>• This field is optional.</li> </ul>
<b>Bundles</b>	<p>A method of grouping TQL queries or views by category. Select the bundles associated with the current query or view or create a new bundle for it.</p> <p><b>Note:</b> This field is optional.</p>
<b>Description</b>	A description of the TQL query or view.
<b>Group by</b>	Select a default layout for the view, when consuming it in IT Universe

UI Element (A-Z)	Description
	<p>Manager or the view preview. The available options are the ones described under Group by in <a href="#">"Topology Map" on page 231</a>.</p> <p><b>Note:</b></p> <ul style="list-style-type: none"> <li>• This field is only relevant for views.</li> <li>• If you select a default layout (other than <b>No Grouping</b>) from this drop-down, the <b>Map Layout</b> field is disabled.</li> </ul>
<b>Inter-Layer Links</b>	<p>Set the scope of inter-layer relationships displayed in the topology results. For details, see <a href="#">"Inter-Layer Relationships" on page 192</a>.</p> <p><b>Note:</b> This field is only relevant for views.</p>
<b>Managed by Configuration Manager</b>	<p>Select the check box to denote the view as managed in HP Universal CMDB Configuration Manager.</p> <p><b>Note:</b> This field is only relevant for views and only when HP Universal CMDB Configuration Manager is configured and running.</p>
<b>Map Layout</b>	<p>Select a default layout for the view, when consuming it in IT Universe Manager or the view preview. The available options are the ones appearing under Layout in the Main Menu.</p> <p><b>Note:</b></p> <ul style="list-style-type: none"> <li>• This field is only relevant for views.</li> <li>• This field is only active when <b>No Grouping</b> is selected under <b>Group by</b>.</li> </ul>
<b>Persistent</b>	<p>Select to define the TQL query as persistent. A persistent query remains in the memory permanently.</p>
<b>Priority</b>	<p>Select a priority level for the TQL query or view from the drop-down list (Low, Medium, High, Express, Not Active). This setting determines how often the query should be rerun automatically by the system to include updated information from the CMDB.</p> <p><b>Note:</b> When you change the priority of a view, the priority of the TQL</p>



UI Element (A-Z)	Description
	<p>query on which the view is based is also changed.</p>
<b>Scope</b>	<p>Select the scope of the TQL query from the drop-down list.</p> <p><b>Note:</b> This field is only relevant for Integration TQL queries.</p>
<b>Type</b>	<p>Select the type of the TQL query from the drop-down list.</p> <p><b>Note:</b> This field is only relevant for TQL queries.</p>
<b>View refresh rate in Configuration Manager</b>	<p>If the view is set as <b>Managed by Configuration Manager</b>, select the view refresh rate from the drop-down list.</p> <p><b>Note:</b> This field is only relevant for views and only when HP Universal CMDB Configuration Manager is configured and running.</p>
<b>View type in Configuration Manager</b>	<p>If the view is set as <b>Managed by Configuration Manager</b>, select the view type from the drop-down list.</p> <p><b>Note:</b> This field is only relevant for views and only when HP Universal CMDB Configuration Manager is configured and running.</p>







## Reveal CIs Dialog Box

This dialog box enables you to search for CIs related to the CIs in a model and add them to the model.

<b>To access</b>	<p>In the Model Editor of the Modeling Studio, select a CI, click the <b>Reveal</b>  button, and select <b>Start Revealing</b> or right-click a CI in the model and select <b>Reveal &gt; Start Revealing</b>.</p>
<b>Important information</b>	<p>The upper pane displays the CI types of the CIs related to the selected CI. The lower pane displays the CIs of the type selected in the upper pane.</p> <p>The first step in the reveal path is the CI type of the CI you began with. When you select a CI type from the list in the upper pane, that CI type becomes the second step in the path. Click <b>Next</b> to display the CI types available for the next step of the path.</p> <p>The number at the top of the box in parentheses indicates the length of the constructed path thus far.</p>

<b>Relevant tasks</b>	<a href="#">"How to Build an Instance-based Model " on page 283</a>
<b>See also</b>	<ul style="list-style-type: none"> <li>• <a href="#">"Revealed CIs and Watchpoints" on page 267</a></li> <li>• <a href="#">"Modeling Studio User Interface" on page 287</a></li> </ul>

User interface elements are described below (unlabeled elements are shown in angle brackets>):

<b>UI Element (A-Z)</b>	<b>Description</b>
	<b>Delete Selected Item(s).</b> Deletes a selected item from the CIs basket.
	<b>CI Properties.</b> Opens the CI Properties dialog box for the selected CI.
	<b>Add CIs to basket.</b> Adds a selected CI from the lower pane to the CIs basket.
	<b>Find Next.</b> Goes to the next occurrence of the selected search phrase in the list of CIs.
	<b>Find Previous.</b> Goes to the previous occurrence of the selected search phrase in the list of CIs.
<b>&lt;Lower pane&gt;</b>	Displays a list of related CIs of the type selected in the upper pane.
<b>CI count</b>	Indicates how many related CIs of each type were found.
<b>CIs Basket</b>	Displays the related CIs you selected to include in the model.
<b>CI Type</b>	Displays a list of CI types of the CIs related to the selected CI.
<b>Conditions</b>	A check mark indicates that conditions were defined for the selected CI type. Click the Conditions column for the CI type you want to select and click the <b>Add Condition</b> or <b>Edit Condition</b> button to open the Conditions of Related CIs dialog box. This enables you to define and edit conditions for the CI type.
<b>Find</b>	Enter a CI name or a portion of a CI name in the Find box to locate a CI in the list of CIs.
<b>Finish</b>	Click <b>Finish</b> when you have finished adding CIs to the CI basket.
<b>Next</b>	Click <b>Next</b> to display the CI types available for the next step of the path.
<b>Reveal path</b>	Displays the reveal path being constructed.  Clicking the blue arrows in the path  displays a drop-down list of the CI types available





UI Element (A-Z)	Description
	<p>for the next step of the path.</p> <p>Clicking the CI types in the path displays the following options:</p> <ul style="list-style-type: none"> <li>• <b>Jump to page.</b> Refreshes the table with the available CI types for the selected step of the path.</li> <li>• <b>Edit Condition.</b> Opens the Conditions of Related CIs dialog box.</li> <li>• <b>Delete Selected Item(s).</b> Deletes the selected CI type from the reveal path (the path ends at the previous CI type).</li> </ul>
<b>Save Path</b>	Opens the Save Reveal Path dialog box which enables you to save the path. This option is only active when a unique reveal path has been constructed.



## Save Query Dialog Box

This dialog box enables you to save a new TQL query.

<b>To access</b>	In the Modeling Studio, click <b>Save</b>  when defining a new TQL query.
<b>Relevant tasks</b>	<a href="#">"How to Define a TQL Query" on page 24</a>
<b>See also</b>	<ul style="list-style-type: none"> <li>• <a href="#">"Viewing TQL Query Results" on page 16</a></li> <li>• <a href="#">"Modeling Studio User Interface" on page 287</a></li> </ul>

User interface elements are described below (unlabeled elements are shown in angle brackets>):

UI Element (A-Z)	Description
	<b>New Folder.</b> Creates a new folder in the resource tree.
	<b>Delete.</b> Deletes the selected resource from the CMDB.
	<b>Refresh.</b> Refreshes the resource tree.
	<b>Expand All.</b> Expands all the folders in the resource tree.
	<b>Collapse All.</b> Collapses all the folders in the resource tree.





UI Element (A-Z)	Description
	<b>Find Next.</b> Goes to the next occurrence of the selected search phrase in the tree.
	<b>Find Previous.</b> Goes to the previous occurrence of the selected search phrase in the tree.
	<b>Highlight All.</b> Highlights all occurrences of the search phrase in the tree.
<Resource tree>	Select a folder in the tree in which to save the query.
<b>Find</b>	Enter a folder name or a portion of a name in the Find box to locate a folder in the list.
<b>Query Name</b>	Enter the name of the new TQL query.



## Save View/Template/Perspective Dialog Box

This dialog box enables you to save a new pattern view, template-based view, perspective-based view, template, or perspective.

<b>To access</b>	In the Modeling Studio, click the <b>Save</b>  button when defining a new pattern view, template-based view, perspective-based view, template, or perspective.
<b>See also</b>	<ul style="list-style-type: none"> <li>• <a href="#">"Building a Business View" on page 255</a></li> <li>• <a href="#">"Modeling Studio User Interface" on page 287</a></li> </ul>

User interface elements are described below (unlabeled elements are shown in angle brackets>):

UI Element (A-Z)	Description
	<b>New Folder.</b> Creates a new folder in the resource tree.
	<b>Delete.</b> Deletes the selected resource from the CMDB.
	<b>Refresh.</b> Refreshes the resource tree.
	<b>Expand All.</b> Expands all the folders in the resource tree.
	<b>Collapse All.</b> Collapses all the folders in the resource tree.

UI Element (A-Z)	Description
	<b>Find Next.</b> Goes to the next occurrence of the selected search phrase in the tree.
	<b>Find Previous.</b> Goes to the previous occurrence of the selected search phrase in the tree.
	<b>Highlight All.</b> Highlights all occurrences of the search phrase in the tree.
<b>&lt;Resource tree&gt;</b>	Select a folder in the tree in which to save the view, template, or perspective.
<b>Find</b>	Enter a folder name or a portion of a name in the Find box to locate a folder in the list.
<b>New query</b>	Select <b>New query</b> if the view is based on a new TQL query.  <b>Note:</b> This field is not relevant for template-based views and perspective-based views.
<b>View Name</b>	Enter the name of the new view, template, or perspective.

## Select Integration Points Dialog Box

This dialog box enables you to select integration points to access the required data sources for a TQL query node.

<b>To access</b>	In the Modeling Studio, right-click a TQL query node and select <b>Select Integration Points</b> .
<b>Important information</b>	You can select the data sources from which the TQL query generates the results for each query node. For details on data sources, see "Integration Studio Overview " in the <i>HP Universal CMDB Data Flow Management Guide</i> .

User interface elements are described below (unlabeled elements are shown in angle brackets):

UI Element (A-Z)	Description
<b>&lt;Integration Point list&gt;</b>	A list of integration points for available data sources.
<b>All Integration</b>	Enables you to include CIs from all UCMDDB and external data sources for the selected query node in the TQL query results.





UI Element (A-Z)	Description
<b>Points</b>	<b>Note:</b> Only includes integration points where the CI type of the selected query node is marked as federated.
<b>Local Data Source</b>	Enables you to include CIs from the UCMDDB only for the selected query node in the TQL query results.
<b>Select Integration Points</b>	Enables you to select integration points to include CIs from the required data sources only for the selected query node in the TQL query results.





## Sort Column Content Dialog Box

This dialog box enables you to set the order of the column content in a report.

<b>To access</b>	In the Modeling Studio, click <b>Set Sort Order</b> in the Query Node Definition pane of the Pattern View Editor (in Report mode).
<b>Important information</b>	The report is sorted by columns following the order of the attributes in the Sorted Columns pane. Each selected column is sorted in ascending or descending order according to your selection.
<b>Relevant tasks</b>	<a href="#">"How to Define Report Settings" on page 281</a>
<b>See also</b>	<ul style="list-style-type: none"> <li>• <a href="#">"Building a Business View" on page 255</a></li> <li>• <a href="#">"Modeling Studio User Interface" on page 287</a></li> </ul>

User interface elements are described below:

UI Element (A-Z)	Description
	<b>Move to Sorted Columns.</b> Moves the selected attribute to the Sorted Columns pane.
	<b>Move to Available Columns.</b> Moves the selected attribute to the Available Columns pane.
	Moves all the attributes to the Sorted Columns pane.
	Moves all the attributes to the Available Columns pane.

UI Element (A-Z)	Description
	Moves the selected attribute down in the Sorted Columns list.
	Moves the selected attribute up in the Sorted Columns list.
	<b>Sort Ascending.</b> Sorts the selected column in ascending order.
	<b>Sort Descending.</b> Sorts the selected column in descending order.
<b>Available Columns</b>	The attributes selected to appear as columns in the report.
<b>Sorted Columns</b>	The columns selected to be sorted.

## Template-based View Wizard

This wizard enables you to define template-based views manually or by importing parameter data from a CSV file.







<b>To access</b>	Click the <b>New</b>  button and select <b>Template Based View</b> .
<b>Important information</b>	The wizard enables you to create multiple template-based views based on the same template. When creating multiple views, the wizard includes the Save Views page as the final page. When creating a single template-based view, the wizard finishes with the Parameters page and opens the new view in the Editor. You can save the new view from within the Editor.
<b>Relevant tasks</b>	<ul style="list-style-type: none"> <li>• <a href="#">"How to Create a Template Based View" on page 278</a></li> <li>• <a href="#">"How to Create Multiple Template Based Views" on page 280</a></li> </ul>
<b>Wizard map</b>	The Template-based View Wizard contains: <a href="#">"Select Template Page"</a> > <a href="#">"Import Parameter Values Page"</a> > <a href="#">"Enter Parameters Page"</a> > <a href="#">"Select Location for Views Page"</a> > <a href="#">"Summary Page"</a> > <a href="#">"Save Views Page"</a>
<b>See also</b>	<ul style="list-style-type: none"> <li>• <a href="#">"Building a Business View" on page 255</a></li> <li>• <a href="#">"Modeling Studio User Interface" on page 287</a></li> </ul>

## Select Template Page

This wizard page enables you to select a template on which to base your view.

<b>Important information</b>	If you don't want to use any of the templates in the tree, you can create a new template first and then build a view based on it. For details on creating a template, see <a href="#">"How to Create a Template" on page 273</a> .
<b>Wizard map</b>	The Template-based View Wizard contains:  <a href="#">"Select Template Page"</a> > <a href="#">"Import Parameter Values Page"</a> > <a href="#">"Enter Parameters Page"</a> > <a href="#">"Select Location for Views Page"</a> > <a href="#">"Summary Page"</a> > <a href="#">"Save Views Page"</a>

User interface elements are described below (unlabeled elements are shown in angle brackets):

<b>UI Element (A-Z)</b>	<b>Description</b>
	<b>Refresh.</b> Refreshes the template tree.
	<b>Expand All.</b> Expands all the folders in the template tree.
	<b>Collapse All.</b> Collapses all the folders in the template tree.
	<b>Find Next.</b> Goes to the next occurrence of the selected search phrase in the tree.
	<b>Find Previous.</b> Goes to the previous occurrence of the selected search phrase in the tree.
	<b>Highlight All.</b> Highlights all occurrences of the search phrase in the tree.
<b>&lt;Template tree&gt;</b>	Displays the existing templates in tree format.
<b>Find</b>	Enter a template name or a portion of a name in the Find box to locate a template in the list.

## Import Parameter Values Page

This wizard page enables you to import parameter values from a CSV file.

<b>Important information</b>	If you are creating a large number of views based on the same template, you can save the parameter values in a CSV file and import them directly into the wizard.  <div style="background-color: #f0f0f0; padding: 5px;"><b>Note:</b> If the CSV file contains any non-English characters, you must use UTF-8 encoding to ensure that the characters are displayed properly.</div>
<b>Wizard map</b>	The Template-based View Wizard contains:



	"Select Template Page" > <b>"Import Parameter Values Page"</b> > "Enter Parameters Page" > "Select Location for Views Page" > "Summary Page" > "Save Views Page"
--	--

User interface elements are described below (unlabeled elements are shown in angle brackets>):

UI Element (A-Z)	Description
<b>Add parameter values manually</b>	Select this option to enter the parameter values manually, whether for a single view or for multiple views.
<b>Import parameter values from a CSV file</b>	Select this option to import the parameter values from a CSV file. Click the ellipsis  button to browse your files for the required file.
<b>Use Advanced Naming</b>	Select the <b>Use Advanced Naming</b> option to automatically name the created views based on parameter values. In the box, enter an expression containing at least one parameter name in angle brackets. The views are named based on the values of the selected parameter.

## Enter Parameters Page

This wizard page enables you to set the values of the template's parameters for each new view created.

<b>Important information</b>	If you are creating multiple views, click <b>Next</b> after you set the parameter values to proceed to the Save Views page. If you are creating a single view, click <b>Finish</b> after you set the parameter values to open the new view in the Editor.
<b>Wizard map</b>	The Template-based View Wizard contains:  <a href="#">"Select Template Page"</a> > <a href="#">"Import Parameter Values Page"</a> > <b><a href="#">"Enter Parameters Page"</a></b> > <a href="#">"Select Location for Views Page"</a> > <a href="#">"Summary Page"</a> > <a href="#">"Save Views Page"</a>

User interface elements are described below (unlabeled elements are shown in angle brackets):

UI Element (A-Z)	Description
	<b>Add view instance.</b> Adds a new view instance.





UI Element (A-Z)	Description
	<b>Remove view instance.</b> Deletes the selected view instance.
<Parameter columns>	In each parameter column, enter or select the required parameter value for each view.
<b>Reset</b>	Click to reset the selected parameter to its original value.
<b>Use Advanced Naming</b>	Select the <b>Use Advanced Naming</b> option to automatically name the created views based on parameter values. In the box, enter an expression containing at least one parameter name in angle brackets. The views are named based on the values of the selected parameter.  <b>Note:</b> All view names must be unique.
<b>View Name</b>	Enter names for each of the new views, or use the default names assigned.



## Select Location for Views Page

This wizard page enables you to select the location in which to save the created views.

<b>Important information</b>	All created views must be saved in the same location.
<b>Wizard map</b>	The Template-based View Wizard contains:  <a href="#">"Select Template Page"</a> > <a href="#">"Import Parameter Values Page"</a> > <a href="#">"Enter Parameters Page"</a> > <b><a href="#">"Select Location for Views Page"</a></b> > <a href="#">"Summary Page"</a> > <a href="#">"Save Views Page"</a>

User interface elements are described below (unlabeled elements are shown in angle brackets>):

UI Element (A-Z)	Description
	<b>New Folder.</b> Creates a new folder in the view tree.
	<b>Refresh.</b> Refreshes the view tree.
	<b>Expand All.</b> Expands all the folders in the view tree.
	<b>Collapse All.</b> Collapses all the folders in the view tree.

UI Element (A-Z)	Description
	<b>Find Next.</b> Goes to the next occurrence of the selected search phrase in the tree.
	<b>Find Previous.</b> Goes to the previous occurrence of the selected search phrase in the tree.
	<b>Highlight All.</b> Highlights all occurrences of the search phrase in the tree.
<b>&lt;View tree&gt;</b>	Select a folder (or the root) from the view tree.
<b>Find</b>	Enter a template name or a portion of a name in the Find box to locate a template in the tree.

## Summary Page

This wizard page displays the details of the created views before saving.

<b>Wizard map</b>	The Template-based View Wizard contains: <a href="#">"Select Template Page"</a> > <a href="#">"Import Parameter Values Page"</a> > <a href="#">"Enter Parameters Page"</a> > <a href="#">"Select Location for Views Page"</a> > <b>"Summary Page"</b> > <a href="#">"Save Views Page"</a>
-------------------	--

User interface elements are described below:

UI Element (A-Z)	Description
<b>Save view summary</b>	A summary of the views created including the name of the base template, the number of views created, and the location selected for saving the views.

## Save Views Page

This wizard page enables you to save the new views you created.

<b>Important Information</b>	This wizard page is only relevant when you are creating multiple template-based views.
<b>Wizard map</b>	The Template-based View Wizard contains: <a href="#">"Select Template Page"</a> > <a href="#">"Import Parameter Values Page"</a> > <a href="#">"Enter Parameters Page"</a> > <a href="#">"Select Location for Views Page"</a> > <a href="#">"Summary Page"</a> > <b>"Save Views Page"</b>

User interface elements are described below:

UI Element (A-Z)	Description
<b>Save Results</b>	A table displays the names of the new views and a message indicating whether each view was saved successfully or not.

## Template Parameter Values Dialog Box

This dialog box enables you to edit the parameters of a template-based view.

<b>To access</b>	From within a template-based view in the Modeling Studio, right-click a query node with parameters defined and select <b>Show Node Parameters</b> , or click the <b>Show Parameters</b>  button on the toolbar.
<b>Important information</b>	When you open the dialog box from the shortcut menu by right-clicking a query node with parameters defined, the dialog box only displays the parameters for the selected query node. When you open the dialog box from the toolbar, it displays all the parameters defined for any of the query nodes in the view.
<b>Relevant tasks</b>	<a href="#">"How to Create a Template Based View" on page 278</a>
<b>See also</b>	<ul style="list-style-type: none"> <li>• <a href="#">"Building a Business View" on page 255</a></li> <li>• <a href="#">"Modeling Studio User Interface" on page 287</a></li> </ul>

User interface elements are described below (unlabeled elements are shown in angle brackets):

UI Element (A-Z)	Description
<b>&lt;Parameters&gt;</b>	Edit the values of the parameters.









## TQL Query Editor



This feature enables you to build and edit TQL queries.

<b>To access</b>	<p>To open a new TQL query in the TQL Query Editor, go to the Modeling Studio, click the <b>New</b>  button and select <b>Query</b>.</p> <p>To open an existing TQL query in the TQL Query Editor, go to the Resources tab of the left pane in the Modeling Studio and select Queries as the Resource type. Right-click a TQL query in the tree and select <b>Open Query</b> or double click a TQL query or drag a TQL query onto the empty canvas. The TQL query opens in a new tab.</p>
------------------	--

<b>Important information</b>	To save your TQL query, use the <b>Save</b> button on the Modeling Studio main toolbar.
<b>Relevant tasks</b>	<a href="#">"How to Define a TQL Query" on page 24</a>
<b>See also</b>	<ul style="list-style-type: none"> <li>• <a href="#">"Viewing TQL Query Results" on page 16</a></li> <li>• <a href="#">"Modeling Studio User Interface" on page 287</a></li> </ul>

User interface elements are described below (unlabeled elements are shown in angle brackets>):

<b>UI Element (A-Z)</b>	<b>Description</b>
	<p><b>Show View Results in IT Universe.</b> Goes directly to the selected view in IT Universe Manager.</p> <p><b>Note:</b> This button only appears for views, templates, or perspectives.</p>
	<p><b>Create Relationship.</b> Enables you to draw a relationship from one query node to another.</p>
	<p><b>Calculate Query Result Count.</b> Calculates the number of instances found for each TQL query node or relationship.</p>
	<p><b>Preview.</b> Displays a preview of the TQL query results as they would appear in IT Universe Manager.</p>
	<p><b>Delete.</b> Deletes the selected query node or relationship from the query.</p>
	<p><b>Query/View Definition Properties.</b></p> <p>For queries, opens the Query Definition Properties dialog box which enables you to edit the type, scope, and priority of the TQL query.</p> <p>For views, opens the View Definition Properties dialog box.</p>
	<p><b>Report Properties.</b> Opens the Report Properties dialog box, which enables you to set the title, subtitle, and format for the view's topology report. For details, see <a href="#">"Report Properties Dialog Box" on page 434</a>.</p> <p><b>Note:</b> This button only appears for views, templates, or perspectives.</p>
	<p><b>Assign Tenants.</b> Opens the Assign Tenants dialog box which enables you to assign</p>

UI Element (A-Z)	Description
	tenants to the resource.  <div style="background-color: #f0f0f0; padding: 5px;"><b>Note:</b> This button is only available when multi-tenancy is enabled.</div>
	<b>Manage Security.</b> Enables you to assign the selected resource to specific roles or resource groups.
	<b>Show Parameters.</b> Opens the Template Parameter Values dialog box which enables you to edit the parameters of a query node in a template-based view.  <div style="background-color: #f0f0f0; padding: 5px;"><b>Note:</b> This button only appears for template-based views.</div>
<b>&lt;Legend&gt;</b>	Indicates the icons displayed next to CIs with any of the following special designations: <ul style="list-style-type: none"> <li>• It is defined as a contact query node in a perspective</li> <li>• It is a federated CI</li> <li>• It has attributes defined</li> <li>• It has selected identities defined</li> <li>• It is hidden in the query results</li> <li>• It is defined as the output query node of a pattern-based model</li> <li>• It has a subgraph defined</li> </ul>
<b>&lt;Main menu&gt;</b>	For details, see <a href="#">"Main Menu" on page 164.</a>
<b>&lt;Shortcut menu options&gt;</b>	For details, see <a href="#">"Shortcut Menu Options" on page 34.</a>
<b>&lt;Topology Map Sidebar&gt;</b>	For details, see <a href="#">"Topology Map Sidebar" on page 176.</a>



### Advanced Pane

This area displays the properties, conditions, and cardinality for the selected query node and

relationship.

<b>Important information</b>	<p>The Advanced pane appears in the lower part of the window in the following managers and user interfaces: Modeling Studio, Impact Analysis Manager, Enrichment Manager, the Input Query Editor and Trigger Query Editor in DFM.</p> <p>A small green indicator  appears next to the tabs that contain data.</p>
<b>Relevant tasks</b>	<ul style="list-style-type: none"> <li>• <a href="#">"How to Define an Impact Rule – Workflow" on page 467</a></li> <li>• <a href="#">"How to Define an Enrichment Rule – Scenario" on page 531</a></li> <li>• <a href="#">"How to Define a TQL Query" on page 24</a></li> <li>• <a href="#">"How to Create a Pattern View" on page 271</a></li> <li>• <a href="#">"How to Create a Template" on page 273</a></li> <li>• <a href="#">"How to Create a Perspective" on page 274</a></li> </ul>

User interface elements are described below:

<b>UI Elements (A-Z)</b>	<b>Description</b>
	If the window is not wide enough to display all the tabs, use the left and right arrows to move to the required tab.
	Click <b>Show List</b> to display a list of the available tabs for the current module. You can select a tab from the list.
<b>Attributes</b>	Displays the attribute conditions defined for the query node or the relationship. For details, see <a href="#">"Attribute Tab" on page 75</a> .
<b>Cardinality</b>	Cardinality defines how many query nodes you expect to have at the other end of a relationship. For example, in a relationship between a node and an IP Address, if the cardinality is 1:3, the TQL query retrieves only those nodes that are connected to between one and three IP Addresses. For details, see <a href="#">"Cardinality Tab" on page 78</a> .
<b>Data Sources</b>	<p>Displays the data sources set for the selected query node.</p> <div style="background-color: #f0f0f0; padding: 5px; margin-top: 10px;"> <p><b>Note:</b> This tab appears only in the Modeling Studio.</p> </div>
<b>Details</b>	Displays the following information:

UI Elements (A-Z)	Description
	<ul style="list-style-type: none"> <li>• <b>CI Type/Element Type.</b> The CIT of the selected query node/relationship.</li> <li>• <b>Element Name.</b> The name of the query node or relationship. This appears only in the Modeling Studio.</li> <li>• <b>Show in query results.</b> A green check indicates that the selected query node/relationship is visible in the topology map. A red mark indicates that it is not visible. In the Modeling Studio, this is indicated by the word Yes or No.</li> <li>• <b>Include subtypes.</b> A green check indicates that both the selected CI and its children are displayed in the topology map. A red mark indicates that only the selected CI appears. This item does not appear in the Modeling Studio.</li> </ul>
<b>Edit</b>	Click <b>Edit</b> to open the relevant dialog box for the selected tab.
<b>Element Layout</b>	<p>Displays the attributes selection for the selected query node or relationship. It lists the attributes selected to be included in the query results (when <b>Specific Attributes</b> is selected as the attributes condition). It also lists the excluded attributes and any selected qualifiers for attributes. For details, see <a href="#">"Element Layout Tab" on page 83</a>.</p> <p><b>Note:</b> This tab appears only in the Modeling Studio.</p>
<b>Element Type</b>	<p>Displays the subtype conditions defined for the query node or relationship. For details, see <a href="#">"Element Type Tab" on page 81</a>.</p> <p><b>Note:</b> This tab appears only in the Modeling Studio.</p>
<b>Enrichment Rules</b>	<p>Displays the Enrichment rule defined for the selected query node or relationship. If the Enrichment rule is used to update the attributes of a CI, click <b>Edit</b> to open the Query Node/Relationship Definition dialog box and edit the rule if required. For details, see <a href="#">"Query Node/Relationship Definition Dialog Box" on page 555</a>.</p> <p><b>Note:</b> This tab appears only in Enrichment Manager.</p>
<b>Impacted Query Nodes</b>	<p>Indicates which query node is impacted by the changes that occur in the selected trigger query node. If required, you can click <b>Edit</b> to open and modify the Impacted Query Nodes dialog box. For details, see <a href="#">"Impacted Query Nodes Dialog Box" on page 478</a>.</p>





UI Elements (A-Z)	Description
	<b>Note:</b> This tab appears only in Impact Analysis Manager.
<b>Qualifiers</b>	Displays the qualifier conditions defined for the query node or the relationship. For details, see <a href="#">"Qualifier Tab" on page 85</a> .  <b>Note:</b> This tab appears only in Enrichment Manager and Impact Analysis Manager.
<b>Selected Identities</b>	Displays the element instances that are used to define what should be included in the TQL query results. For details, see <a href="#">"Identity Tab" on page 86</a> .

## Views Containing Selected CI Dialog Box

This dialog box enables you to display a list of the views containing the selected CI.

<b>To access</b>	Click the <b>Show views containing selected CI/model</b>  button in the Model Editor or select <b>Show containing views</b> from the shortcut menu.
<b>See also</b>	<ul style="list-style-type: none"> <li>• <a href="#">"Building a Business View" on page 255</a></li> <li>• <a href="#">"Modeling Studio User Interface" on page 287</a></li> </ul>

User interface elements are described below:

UI Element (A-Z)	Description
	<b>Show View Results in IT Universe.</b> Goes directly to the selected view in IT Universe Manager.
	<b>Delete Selected Item(s).</b> Deletes the selected view.
	<b>Disconnect view from perspective.</b> Disconnects the selected view from its perspective. The view becomes a pattern view.
<b>Find</b>	Enter a view name or a portion of a view name in the Find box to locate it in the list.
<b>Find Next</b>	Click to go to the next occurrence of the selected search phrase in the list.
<b>Find</b>	Click to go to the previous occurrence of the selected search phrase in the list.

UI Element (A-Z)	Description
<b>Previous</b>	
<b>Highlight</b>	Click to highlight all occurrences of the search phrase in the list.
<b>View Name</b>	Displays the list of views dependent on the selected template or perspective.  <div style="background-color: #f0f0f0; padding: 5px;"><b>Note:</b> The name of the current view appears in faded text.</div>

## Watchpoints Updates Dialog Box

This dialog box displays the changes found in related CIs by a watchpoint defined for a model.

<b>To access</b>	From within a model in the Model Editor, click the <b>Watchpoint</b>  button and select <b>Watchpoints Updates</b> or right-click a CI in the model and select <b>Watchpoint &gt; Watchpoints Updates</b> .
<b>Important information</b>	The Watchpoints Updates dialog box indicates any changes found involving the CIs related to the model via the associated reveal path. If a new related CI is found which is not included in the model, the suggested update is an added CI. If a CI in the model is found to no longer be related via the path, the suggested update is a removed CI.  This option is only enabled when watchpoints are defined for the model and CIs have been found.
<b>See also</b>	<ul style="list-style-type: none"> <li>• <a href="#">"Revealed CIs and Watchpoints" on page 267</a></li> <li>• <a href="#">"Modeling Studio User Interface" on page 287</a></li> </ul>

User interface elements are described below:

UI Element (A-Z)	Description
<b>Accept</b>	Select the check boxes for the CIs you want to add to your model or remove from your model.
<b>Accept All</b>	Click <b>Accept All</b> to apply all the suggested changes to your model.
<b>CI</b>	The names of the CIs found by the watchpoint.
<b>CI Type</b>	The types of the CIs found by the watchpoint.
<b>Clear All</b>	Click <b>Clear All</b> to clear the check boxes for all the found CIs.

UI Element (A-Z)	Description
<b>Restore</b>	Select the check boxes for the CIs in the Suppressed CIs pane that you want to consider for inclusion in your model.
<b>Show/Hide Suppressions</b>	Toggle between hiding and displaying the Suppressed CIs pane of the dialog box.
<b>Suggested Update</b>	Indicates whether the suggested change is an added CI or a removed CI.
<b>Suppress</b>	Select the check boxes for the CIs you want to exclude from your model or leave in your model.
<b>Suppress All</b>	Click <b>Suppress All</b> to decline all the suggested changes to your model.

## <Query/Template/Perspective Name> Dependencies Dialog Box

This dialog box enables you to clarify the status of dependent resources when saving changes to a query, template, or perspective.

<b>To access</b>	In the Modeling Studio, make a change to a query, template, or perspective with dependent resources. When you click <b>Save</b> , the dialog box opens.
<b>Important information</b>	<p>Any change made to a resource affects the views or custom reports based on that resource. Before the changes are saved, you need to specify the desired result on the dependent resources. For each dependent resource, select one of the available options: Delete or Re-Apply.</p> <p>Dependent resources include views based on a query, template, or perspective, and custom reports based on a view, for example, a View Change report.</p>

User interface elements are described below:

UI Element (A-Z)	Description
<b>Delete</b>	Select this option to delete the selected dependent resource.
<b>Re-Apply</b>	Select this option to apply the revised query, template, or perspective to the selected dependent view. The view type remains the same as it was previously (pattern view, template-based view, or perspective-based view). In the case of custom reports, the report is updated according to the revised view.
<b>Resource</b>	The dependent resources are displayed in a tree format.

# Chapter 9: Reports

This chapter includes:

Topology Reports Overview .....	356
Custom Reports Overview .....	357
How to View a Topology Report .....	357
How to Generate a Custom Report .....	358
How to Compare CIs .....	359
How to Compare Snapshots .....	360
How to Enable Hyperlinks and Display Icons .....	362
Cron Expressions .....	362
Reports User Interface .....	363
Reports on Non-English Locales – Notes and Limitations .....	464

## Topology Reports Overview

Topology reports provide a method of displaying the data from views in a report format. Every view defined in the Modeling Studio has a corresponding topology report in the Reports module. The report settings are defined in the view definition in Report mode in the Pattern View Editor. For details, see ["Pattern View Editor" on page 321](#).

For details on selecting the CIs to be displayed in a view, see ["Working with the CI Selector" on page 130](#).

Perspectives, perspective-based views and template-based views also have topology reports. The reports settings for such views are based on the settings defined in the base template or perspective.

You can open a template in the Reports module and edit the template parameters. You can then save the template instance as a template-based view by clicking **Save As View**.

### Report Properties

There are two formats for the topology report tables:

- **Flat.** In a flat report, the top layer of the report is displayed with the CIs with children appearing as links. You can click a CI to drill down to see its children. You can navigate back to higher layers of the report using the breadcrumbs appearing at the top of the report.
- **Hierarchical.** In a hierarchical report, all the CIs of the report are displayed in the same table, in tree format. CIs with children are expandable to display the child CIs beneath them.

Another important difference between flat and hierarchical reports relates to the definition of charts for the report. In a flat report, you can define a chart for any layer of the report, even if a higher layer is in table format. In hierarchical reports, you cannot define a chart for a layer if the layer above it is in table format.

The report format can be set in the Report Properties dialog box, available in both Modeling Studio and the Reports module. For details, see ["Report Properties Dialog Box" on page 434](#).

## Custom Reports Overview

Custom reports consist of charts and tables that help you track and analyze the health of your monitored environment. They enable you to view and assess performance data collected by HP Universal CMDB and stored in the CMDB. When generating reports, you can specify various report settings, such as time range or location, as well as drill down to see further information.

## How to View a Topology Report

This task describes how to create a report based on a previously saved view or pattern.

This task includes the following steps:

- ["Prerequisite" below](#)
- ["Select a Report" on the next page](#)
- ["Edit Template Parameters" on the next page](#)

### 1. Prerequisite

(Optional) Use the Modeling Studio to define a new view. For details, see ["Modeling Studio" on page 254](#).

## 2. Select a Report

In the Reports module, select an existing Topology report which corresponds to a view of the same name. Double-click it or right-click it and select **Open Report**. The report opens in the right pane. For details, see ["Topology Report" on page 453](#).

## 3. Edit Template Parameters

If you selected a report corresponding to a template, edit the template parameters and generate the report. Click **Save As View** to save it as a template-based view.

# How to Generate a Custom Report

This task describes how to define and generate a report based on a custom layout.

This task includes the following steps:

- ["Select the Report Type" below](#)
- ["Specify the Required Parameters" below](#)
- ["Generate the Report" below](#)

## 1. Select the Report Type

In the Custom Reports pane, do one of the following:

- Right-click a report name and select **Create New Report**.
- Click the **Create New Report**  button and select the required report.
- Double-click a report name.

## 2. Specify the Required Parameters

Specify the parameters required by the report type that you selected. For details about the parameters required by each report type, see the relevant report listed in ["Reports User Interface" on page 363](#).

## 3. Generate the Report

Click **Generate** to build the report. If desired, you can refine the parameters and click **Generate** again to view an updated report.

## How to Compare CIs

This task explains how to compare the hierarchies of two compound CIs, view a CI's configuration document, and show the difference between two configuration documents.

This task includes the following steps:

- ["Select the Required CIs" below](#)
- ["View a CI's Configuration Document" on the next page](#)
- ["Show the Difference Between Two Configuration Documents" on the next page](#)

### 1. **Select the Required CIs**

In IT Universe Manager, select the two CIs you want to compare. The hierarchies of the two compound CIs are compared in the Compare CIs report (for details, see ["Compare CIs Report" on page 390](#)). You can choose to compare two CIs that appear in a selected view, or in the CMDB. For details, see ["CI Selector" on page 135](#).

#### **Example of Nonmatching CIs:**

In this example, the **No Matching CI** icon is displayed next to the CI **LABM3QCRNDDB03** because it has no corresponding CI on the other side.

The **Show Different Attribute Values** icon is displayed next to the **MemorySize** properties for the CIs **LABM3QCRNDDB02** and **LABM3ASTDB01** since they have different **MemorySize** values.

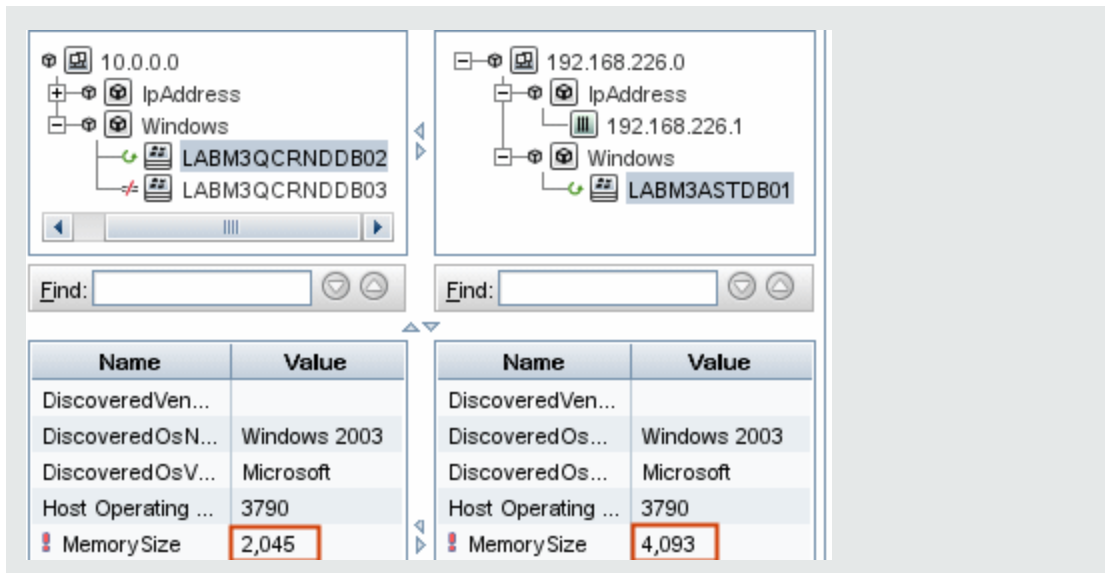

## 2. View a CI's Configuration Document

Select a CI of the CIT **Configuration Document** and view the configuration document. For details, see ["Compare CIs Report" on page 390](#).

## 3. Show the Difference Between Two Configuration Documents

Select two CIs of the CIT **Configuration Document** and view the difference between the two configuration documents. For details, see ["Compare CIs Report" on page 390](#).

# How to Compare Snapshots

This task describes how to take a snapshot of a view, and to compare two snapshots of a specific view taken at different times.

This task includes the following steps:

- ["Take a Snapshot of a View " on the next page](#)
- ["Save Snapshots on a Periodic Basis" on the next page](#)
- ["Compare Snapshots" on the next page](#)



### 1. Take a Snapshot of a View

- a. Select a view in IT Universe Manager or a Topology report in the Reports module.
- b. Click the **Snapshot**  button and select **Save Snapshot** to take a snapshot of the view and save it. For details, see the "[Save Snapshot Dialog Box](#)" on page 249.

### 2. Save Snapshots on a Periodic Basis

Optionally, you can schedule snapshots to be taken of a certain view at specific times by defining a task. For details, see "[Schedule Report/Snapshot Dialog Box](#)" on page 444.





### 3. Compare Snapshots



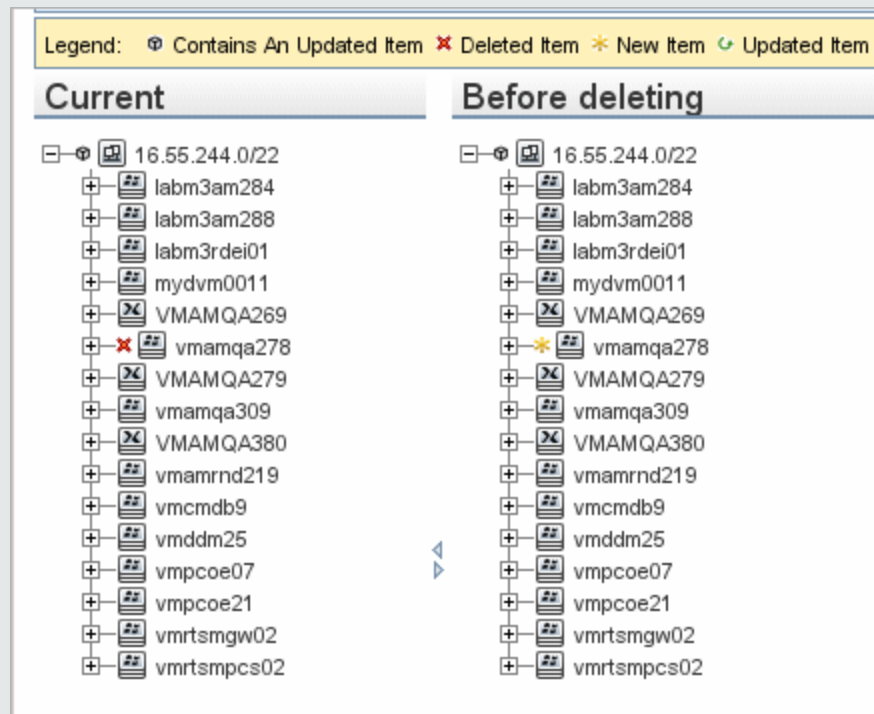

































Compare the snapshots of a view taken at different times. Select **Modeling > Reports** and create a Compare Snapshots Report. For details, see "[Compare Snapshots Report](#)" on page 395.

#### Example of Snapshots of a View Taken at Different Times:

In the following example, the **Deleted Item** icon next to the **vmamqa278** CI in the left pane, indicates that the CI has been deleted in the newer view.



Legend:  Contains An Updated Item  Deleted Item  New Item  Updated Item

Current	Before deleting
 16.55.244.0/22	 16.55.244.0/22
 labm3am284	 labm3am284
 labm3am288	 labm3am288
 labm3rdei01	 labm3rdei01
 mydvm0011	 mydvm0011
 VMAMQA269	 VMAMQA269
  vmamqa278	  vmamqa278
 VMAMQA279	 VMAMQA279
 vmamqa309	 vmamqa309
 VMAMQA380	 VMAMQA380
 vmamrnd219	 vmamrnd219
 vmcmdb9	 vmcmdb9
 vmddm25	 vmddm25
 vmpcoe07	 vmpcoe07
 vmpcoe21	 vmpcoe21
 vmrtsmgw02	 vmrtsmgw02
 vmrtsmpcs02	 vmrtsmpcs02

## How to Enable Hyperlinks and Display Icons

To enable hyperlinks in reports, set the infrastructure setting **Enable links in exported reports** to **TRUE**.

To display icons in exported reports, set the infrastructure setting **Display icons in exported reports** to **TRUE**.

## Cron Expressions

A Cron Expression is a string composed of six or seven fields separated by white space. Six of the fields are mandatory, and one is optional.

The following table contains the fields used in a Cron Expression:

Field Name	Allowed Values	Allowed Special Characters
Seconds	0-59	, - * /
Minutes	0-59	, - * /
Hours	0-23	, - * /
Day of month	1-31	, - * ? / L W C
Month	1-12 or JAN-DEC	, - * /
Day of week	1-7 or SUN-SAT	, - * ? / L C #
Year (optional)	empty, 1970-2099	, - * /

**Note:** You cannot specify both **Day of Month** and **Day of Week**; you must use the ? character in one or both of these fields.

The following table contains examples of how to use Cron expressions.

Cron Expression	Meaning
0 0 12 * * ?	The task runs every day at 12:00 PM.
0 15 10 ? * *	The task runs at 10:15 AM every day.

Cron Expression	Meaning
<b>0 15 10 * * ? 2011</b>	The task runs at 10:15 AM every day during the year 2011.
<b>0 0/5 14 * * ?</b>	The task runs every 5 minutes starting at 2 PM and ending at 2:55 PM, every day.
<b>0 15 10 15 * ?</b>	The task runs at 10:15 AM on the 15th day of every month.
<b>0 15 10 ? * 6L</b>	The task runs at 10:15 AM on the last Friday of every month.
<b>0 15 10 ? * 6#3</b>	The task run at 10:15 AM on the third Friday of every month.

## Reports User Interface

This section includes (in alphabetical order):



Agent Status Report .....	365
Application Breakdown Report .....	367
Application License Report .....	369
Asset Report .....	371
Auditing Report .....	372
Changed Application Report .....	377
Changed Views Report .....	379
CI Change Report .....	380
CMDB Utilization Report .....	385
Compare Archives Report .....	386
Compare CIs Report .....	390
Compare Snapshots Report .....	395
Configuration Manager Policy Report .....	399
Database Breakdown Report .....	401
Delete Candidates Report .....	404
Dependency Report .....	405
Discovery Errors Report .....	407
Generic Breakdown Report .....	409

Gold Master Report .....	411
Hardware Component Summary Report .....	414
Impact Analysis Report .....	415
Job List Dialog Box .....	417
Licensed OSIs Report .....	419
Migration Progress Report .....	422
Network Device Breakdown Report .....	422
Node OS Breakdown Report .....	425
Node Summary Report .....	427
Node Summary by VLAN Report .....	429
Number of Changes Report .....	431
Recognized Applications Report .....	433
Report Properties Dialog Box .....	434
Reports Page .....	435
Rulebase Support Report .....	440
Scan File Status Report .....	441
Scanner Execution Details Report .....	442
Schedule Report/Snapshot Dialog Box .....	444
Service Discovery Errors Report .....	448
Software Utilization Report .....	450
Solaris Zone Report .....	452
Topology Report .....	453
View Change Report .....	454
VMware Host Report .....	456
VMware Virtual Center Report .....	457
Zone-Based Discovery Errors Report .....	458
Report Toolbar Options .....	460

## Agent Status Report

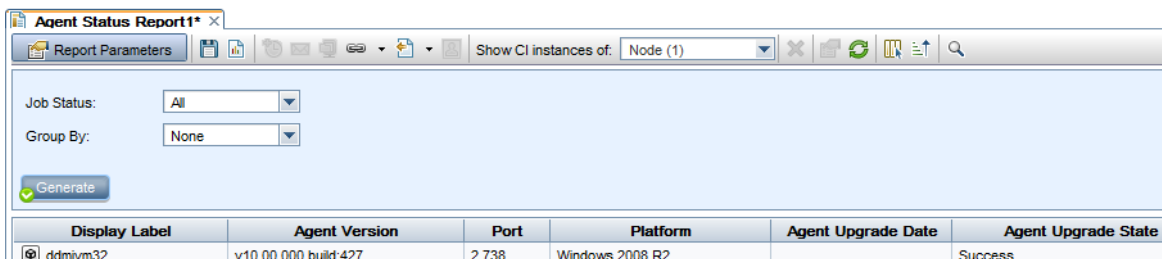
This report displays the status of all installed discovery agents that have been updated by the **Upgrade UD Agent** discovery job.



<p><b>To access</b></p>	<p>Select <b>Managers &gt; Modeling &gt; Reports</b>. In the <b>Custom Reports</b> pane, do one of the following:</p> <ul style="list-style-type: none"> <li>• Click the <b>Create New Report</b>  button and select <b>Agent Status Report</b>.</li> <li>• Under <b>Discovery Status</b>: <ul style="list-style-type: none"> <li>◦ Double-click <b>Agent Status Report</b>.</li> <li>◦ Right-click <b>Agent Status Report</b> and select <b>Create New Report</b>.</li> <li>◦ Select <b>Agent Status Report</b>, and drag it onto the right pane.</li> </ul> </li> </ul>
<p><b>Important information</b></p>	<p>The report displays detailed information on each discovery agent including the display label, agent version, port, platform, and probe name.</p> <p>Use the <b>Select Columns</b>  button to select the attributes to display in the report.</p>
<p><b>Relevant tasks</b></p>	<p><a href="#">"How to Generate a Custom Report" on page 358</a></p>

User interface elements are described below (unlabeled elements are shown in angle brackets):

<p><b>UI Element (A-Z)</b></p>	<p><b>Description</b></p>
<p><b>&lt;Shortcut Menu&gt;</b></p>	<p>Right-click a CI in the report to access the IT Universe Manager shortcut menu. For details, see <a href="#">"IT Universe Manager Shortcut Menu" on page 235</a>.</p>
<p><b>&lt;Toolbar&gt;</b></p>	<p>For details, see <a href="#">"Report Toolbar Options" on page 460</a>.</p>

<b>UI Element (A-Z)</b>	<b>Description</b>
<b>Group By</b>	Select a grouping method for displaying the data. The available options are: <ul style="list-style-type: none"><li>• None</li><li>• Job Status</li><li>• Agent Version</li></ul>
<b>Job Status</b>	Select an option from the drop-down list to filter the results by the job status of the agent's discovery jobs.

## Application Breakdown Report

This report displays a breakdown of major applications and their versions. Major applications are Running Software CITs that have been assigned the **MAJOR\_APP** class qualifier. For details, see ["Qualifiers Page" on page 512](#).

Include All Integration Points

Country or Province:

State:

City:

[Applications Breakdown](#)

### Applications Breakdown

Break down by Count

[Click on the chart sections to drill down](#)

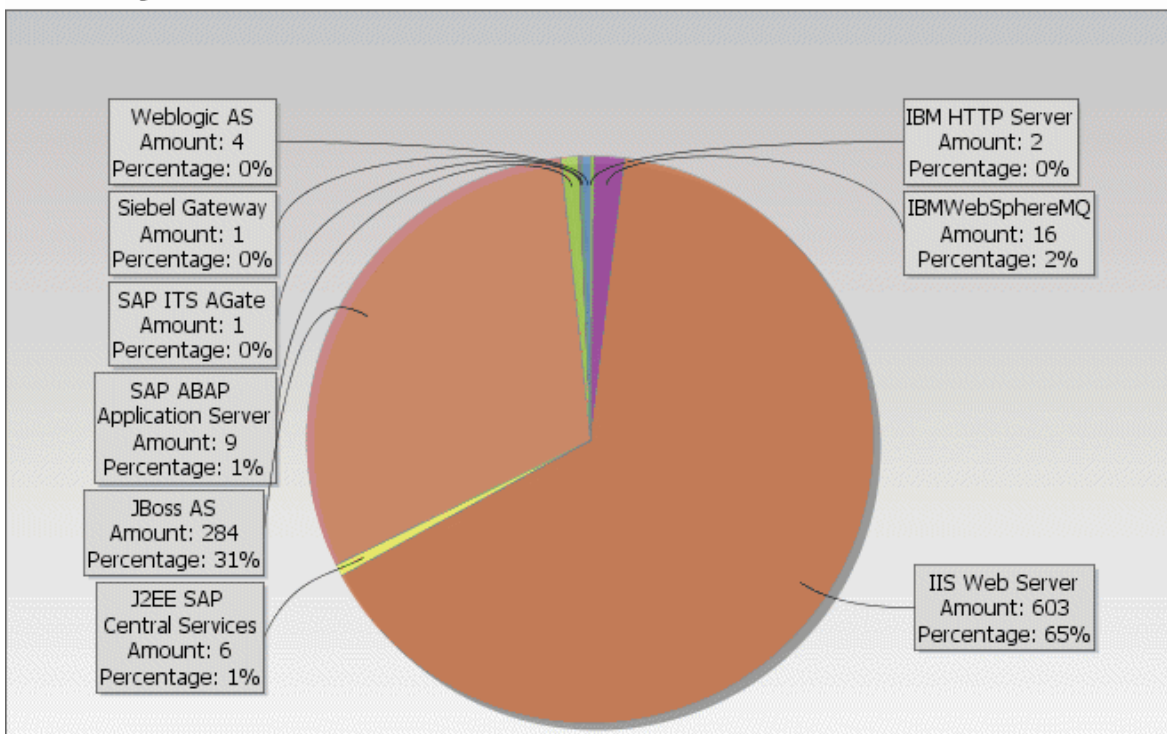

**To access**

Select **Managers > Modeling > Reports**. In the **Custom Reports** pane, do one of the following:

- Click the **Create New Report**  button and select **Application Breakdown**

	<p><b>Report.</b></p> <ul style="list-style-type: none"> <li>• Under <b>Breakdown:</b> <ul style="list-style-type: none"> <li>◦ Double-click <b>Application Breakdown Report</b>.</li> <li>◦ Right-click <b>Application Breakdown Report</b> and select <b>Create New Report</b>.</li> <li>◦ Select <b>Application Breakdown Report</b>, and drag it onto the right pane.</li> </ul> </li> </ul>
<b>Relevant tasks</b>	<a href="#">"How to Generate a Custom Report" on page 358</a>

User interface elements are described below (unlabeled elements are shown in angle brackets):

<b>UI Element (A-Z)</b>	<b>Description</b>
<b>&lt;Bar graph/ Pie chart&gt;</b>	<p>Each segment of the pie chart/column in a bar graph represents a different application.</p> <p>Click a slice/bar to view the application sorted by version, and then drill down to see the application instances and their attributes.</p> <p>When you hold the mouse over each segment/bar, a tooltip indicates the name of the application, the number of CI instances found for each application, the percentage of the pie it represents (when viewing the information in pie chart format), and the CI type the slice/bar represents.</p> <p>The legend below the pie chart provides the name of each CI, and on the lower level, their versions.</p>
<b>&lt;Breadcrumbs&gt;</b>	<p>Displays the levels through which you have navigated to get to the current level. Appears horizontally across the top of the chart.</p> <p><b>Note:</b> Each level in the list of breadcrumbs is a clickable link.</p>
<b>&lt;Shortcut Menu&gt;</b>	<p>Drill down to the level of individual CIs and right-click a CI in the report to access the IT Universe Manager shortcut menu. For details, see <a href="#">"IT Universe Manager Shortcut Menu" on page 235</a>.</p>
<b>&lt;Toolbar&gt;</b>	<p>For details, see <a href="#">"Report Toolbar Options" on page 460</a>.</p>
<b>City</b>	<p>Select the city for which you want to view application breakdown data, or select <b>All</b> to show the breakdown for all cities.</p> <p><b>Note:</b> This is only relevant for CITs that contain data in the <b>City</b> attribute.</p>





UI Element (A-Z)	Description
<b>Country or Province</b>	Select the country or province for which you want to view application breakdown data, or select <b>All</b> to show the breakdown for all countries or provinces.  <b>Note:</b> This is only relevant for CITs that contain data in the <b>Country or Province</b> attribute.
<b>Include All Integration Points</b>	Select the check box to include federated CIs in the report. When the check box is cleared, only local CIs are included in the report.
<b>State</b>	Select the state for which you want to view application breakdown data, or select <b>All</b> to show the breakdown for all states.  <b>Note:</b> This is only relevant for CITs that contain data in the <b>State</b> attribute.

## Application License Report

This report displays all the application instances detected in the system that require a license.

Application Name	Total Installed	License Required
7Zip	1	0
Active Perl	2	0
Administration Assistant for Windows	2	0
Chrome Frame	1	0
CommTax: Communications Tax L	1	0
FileZilla Client	2	0
FineReader Engine	1	0
Firefox	2	0
Google Chrome Browser	1	0
HP Application Lifecycle Management Client	1	0
HP Application Lifecycle Management Platform	1	0
HP Asset Manager	2	2
HP Asset Manager API	1	0

<b>To access</b>	<p>Select <b>Managers &gt; Modeling &gt; Reports</b>. In the <b>Custom Reports</b> pane, do one of the following:</p> <ul style="list-style-type: none"> <li>Click the <b>Create New Report</b>  button and select <b>Application License Report</b>.</li> <li>Under <b>Inventory</b>: <ul style="list-style-type: none"> <li>Double-click <b>Application License Report</b>.</li> </ul> </li> </ul>
------------------	---

	<ul style="list-style-type: none"> <li>Right-click <b>Application License Report</b> and select <b>Create New Report</b>.</li> <li>Select <b>Application License Report</b>, and drag it onto the right pane.</li> </ul>
<b>Important information</b>	<p>The top level of the report displays the number of application instances for each application, vendor, or related node, depending on the grouping option selected. This is based on the license type for each application as defined in the SAI files.</p> <p>In any layer, you can use the <b>Select Columns</b>  button to select the attributes to display in the report.</p>
<b>Relevant tasks</b>	<a href="#">"How to Generate a Custom Report" on page 358</a>

User interface elements are described below (unlabeled elements are shown in angle brackets):

<b>UI Element (A-Z)</b>	<b>Description</b>
<b>&lt;Breadcrumbs&gt;</b>	<p>Displays the levels through which you have navigated to get to the current level. Appears horizontally across the top of the chart.</p> <p><b>Note:</b> Each level in the list of breadcrumbs is a clickable link.</p>
<b>&lt;Shortcut Menu&gt;</b>	Right-click a CI in the report to access the IT Universe Manager shortcut menu. For details, see <a href="#">"IT Universe Manager Shortcut Menu" on page 235</a> .
<b>&lt;Toolbar&gt;</b>	For details, see <a href="#">"Report Toolbar Options" on page 460</a> .
<b>Group By</b>	<p>Select the method for displaying the data. The available options are:</p> <ul style="list-style-type: none"> <li>Application Name</li> <li>Vendor Name</li> <li>Related Node</li> </ul>
<b>License Required</b>	<p>For each application, vendor, or related node, displays the number of applications that require a license. Click the number to drill down and view the application instances.</p> <p>On the drill down screen, if the number in the Components column is greater than 0, then the selected application has licensing components.</p>

## Asset Report

This report displays a list of all the CIs in a specified view, their attribute values, as well as their child CIs in the CMDB. You use Asset reports to view and analyze the contents of the view and focus on the data that is of interest to you. For example, an Asset report can display a list of all the servers that are part of a specific application contained in the view.

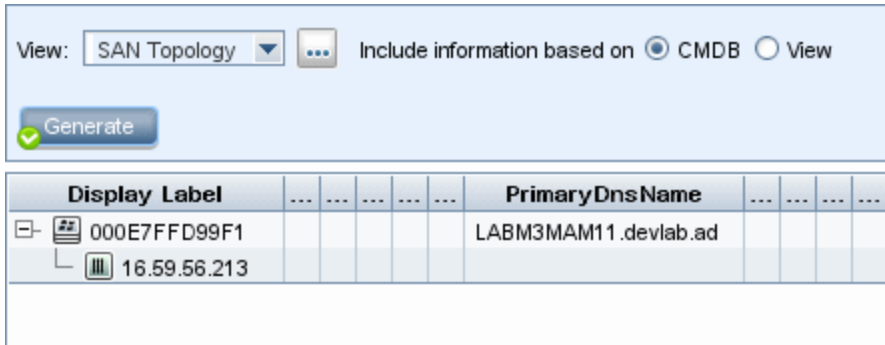

<p><b>To access</b></p>	<p>Select <b>Managers &gt; Modeling &gt; Reports</b>. In the <b>Custom Reports</b> pane, do one of the following:</p> <ul style="list-style-type: none"> <li>• Click the <b>Create New Report</b>  button and select <b>Asset Report</b>.</li> <li>• Under <b>General</b>:             <ul style="list-style-type: none"> <li>◦ Double-click <b>Asset Report</b>.</li> <li>◦ Right-click <b>Asset Report</b> and select <b>Create New Report</b>.</li> <li>◦ Select <b>Asset Report</b>, and drag it onto the right pane.</li> </ul> </li> </ul>
<p><b>Important information</b></p>	<p>The report only includes attributes that are marked with the <b>Asset Data</b> qualifier in the <b>Attributes</b> tab in the CI Type Manager. For more details, see <a href="#">"Add/Edit Attribute Dialog Box" on page 497</a>.</p>
<p><b>Relevant tasks</b></p>	<p><a href="#">"How to Generate a Custom Report" on page 358</a></p>

User interface elements are described below (unlabeled elements are shown in angle brackets):

<p><b>UI Element (A-Z)</b></p>	<p><b>Description</b></p>
<p>&lt;Shortcut menu&gt;</p>	<p>For details, see <a href="#">"IT Universe Manager Shortcut Menu" on page 235</a>.</p>

UI Element (A-Z)	Description
<Toolbar>	For details, see <a href="#">"Report Toolbar Options" on page 460.</a>
<b>Include information based on</b>	<p>Select one of the following:</p> <ul style="list-style-type: none"> <li>• <b>CMDB.</b> Includes information from the selected view as well as information about the child CIs and their attribute values in the CMDB.</li> </ul> <p>In this option, the report includes CIs that are connected to the CIs in selected view by relationships with the <b>Container</b> qualifier. For example, the report includes the CPU and memory of a server that is contained in the view.</p> <ul style="list-style-type: none"> <li>• <b>View.</b> Includes only information about the CIs and their attributes that are contained in the selected view.</li> </ul>
<b>View</b>	<p>Enables you to select a view by opening the View Selector. For details, see <a href="#">"CI Selector" on page 135.</a></p> <div style="border: 1px solid gray; padding: 5px; background-color: #f0f0f0;"> <p><b>Note:</b> When you generate an Asset report from a specific view, the report retains the same hierarchical structure as the relevant view in the Topology Map.</p> </div>

## Auditing Report

This report displays auditing information about CIs, Relationships and many Unified Resource Manager (URM) resources.

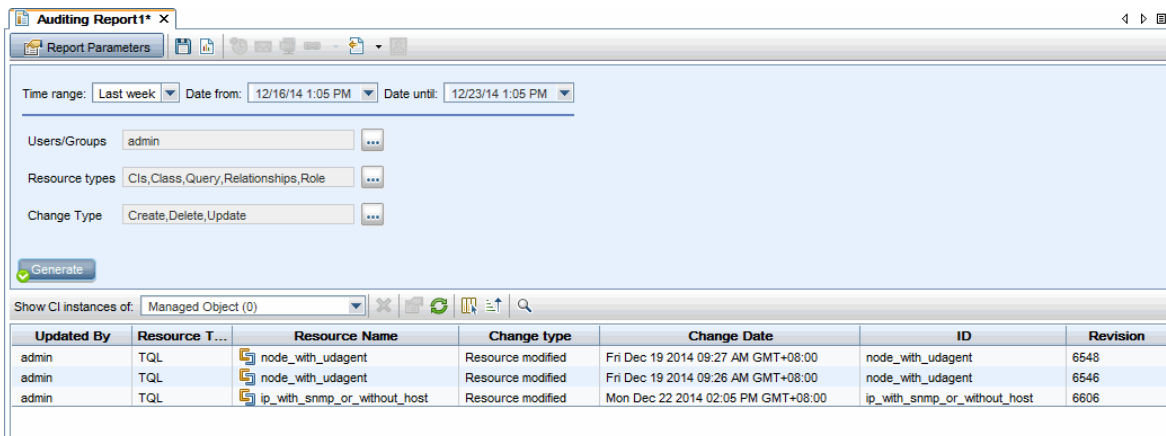



<b>To access</b>	Select <b>Managers &gt; Modeling &gt; Reports.</b> In the <b>Custom Reports</b> pane, do one of the following:
------------------	--



	<ul style="list-style-type: none"><li>• Click <b>Create New Report</b>  and select <b>Auditing Report</b>.</li><li>• Under <b>Administration</b>:<ul style="list-style-type: none"><li>◦ Double-click <b>Auditing Report</b>.</li><li>◦ Right-click <b>Auditing Report</b> and select <b>Create New Report</b>.</li><li>◦ Select <b>Auditing Report</b> and drag it onto the right pane.</li></ul></li></ul>
<b>Important information</b>	<ul style="list-style-type: none"><li>• The report is visible only for users with Auditing permission.</li><li>• The out-of-the-box TenantAdmin role does not have Auditing permission and cannot create Auditing reports.</li><li>• The report supports all standard features of any custom report such as:<ul style="list-style-type: none"><li>◦ Email</li><li>◦ Scheduling</li><li>◦ Export (only CSV, Excel, and XML)</li><li>◦ Saving the input parameters</li></ul></li><li>• Exploring changes is enabled by right-clicking a row:<ul style="list-style-type: none"><li>◦ For CIs and Relationships:<p>A shortcut menu appears, including options related to CIs, such as <b>CI History</b>.</p>Exploring shows the history within the selected time frame.</li><li>◦ For URM resources:<p>Exploring is used for comparing a base revision with any other changes made on the URM resources.</p></li></ul></li></ul> <div data-bbox="480 1535 1370 1787" style="background-color: #f0f0f0; padding: 10px;"><p><b>Note:</b></p><ul style="list-style-type: none"><li>• Results cannot be retrieved after purging the history from the JMX.</li><li>• Changes that are made by the probe through the discovery process or made through the integration points do not appear in the report output.</li></ul></div> <p>Click <b>Explore Resource</b>. The Compare Revisions dialog opens, displaying a text</p>

	<p>area with the same Diff code as in the JMX. The XML of the current selected revision is displayed in the left panel, and users can select any other revision of the same resource to display in the right panel.</p> <p>Different colors indicate different changes as follows:</p> <ul style="list-style-type: none"> <li>• Green color for modified lines.</li> <li>• Red color for removed lines.</li> <li>• Yellow color for added lines.</li> </ul>
<b>Relevant tasks</b>	"Generate a Custom Report" in the <i>HP Universal CMDB Modeling Guide</i> .

User interface elements are described below (unlabeled elements are shown in angle brackets):

<b>UI Element (A-Z)</b>	<b>Description</b>
<b>&lt;Shortcut Menu&gt;</b>	Right-click a CI in the report to access the IT Universe Manager shortcut menu. For details, see <a href="#">"IT Universe Manager Shortcut Menu" on page 235</a> .
<b>&lt;Toolbar&gt;</b>	For details, see <a href="#">"Report Toolbar Options" on page 460</a> .
<b>Date from</b>	Configure a start date and time for the report.
<b>Date until</b>	Configure an end date and time for the report.
<b>Time range</b>	<p>Select a time frame for the changes that you want to display. The system automatically provides the starting and ending dates in the <b>Date from</b> and <b>Date until</b> boxes.</p> <p><b>Note:</b> If you select <b>Custom</b>, you can manually configure a start and end date in the <b>Date from</b> and <b>Date until</b> boxes.</p>
<b>Users/Groups</b>	Click  and select users and/or groups for the report.
<b>Resource types</b>	<p>Click  and select resource types to include in the auditing report. The available resource types are as follows:</p> <ul style="list-style-type: none"> <li>• CIs</li> <li>• Class</li> <li>• Customer Setting</li> </ul>

UI Element (A-Z)	Description
	<ul style="list-style-type: none"> <li>• Deployed Package</li> <li>• Discovery Script</li> <li>• Enrichment Rule</li> <li>• Global Setting</li> <li>• Identification Rule</li> <li>• Impact Rule</li> <li>• Integration Point</li> <li>• Query</li> <li>• Relationships</li> <li>• Resource Group</li> <li>• Resource Tenants Association</li> <li>• Role</li> <li>• Role Assignment</li> <li>• Scheduled Report</li> <li>• System Type</li> <li>• User</li> <li>• Users Group</li> <li>• View</li> </ul>
<p><b>Change Type</b></p>	<p>Click  and select the change type for the report. The available types are as follows:</p> <ul style="list-style-type: none"> <li>• Create</li> <li>• Delete</li> <li>• Update</li> </ul>

UI Element (A-Z)	Description
 	<p><b>Generate Report.</b> Enables you to generate the selected report.</p> <p><b>Note:</b> This button appears disabled prior to defining the report parameters.</p>
<p><b>&lt;Generated report&gt;</b></p>	<p>Displays the generated report.</p> <p>The generated report contains the following columns:</p> <ul style="list-style-type: none"> <li>• <b>Updated By:</b> The user name of the administrator who updated the item.</li> <li>• <b>Resource Type:</b> Resource type for the item.</li> <li>• <b>Resource Name:</b> Resource name for the item.</li> <li>• <b>Change Type:</b> Change type for the item.</li> <li>• <b>Change Date:</b> Date and time when the item was changed.</li> <li>• <b>ID:</b> Identifier for the item.</li> <li>• <b>Revision:</b> Revision number for the item.</li> </ul>



## Changed Application Report

This report displays a bar graph showing the number of detected changes in applications within a defined period.

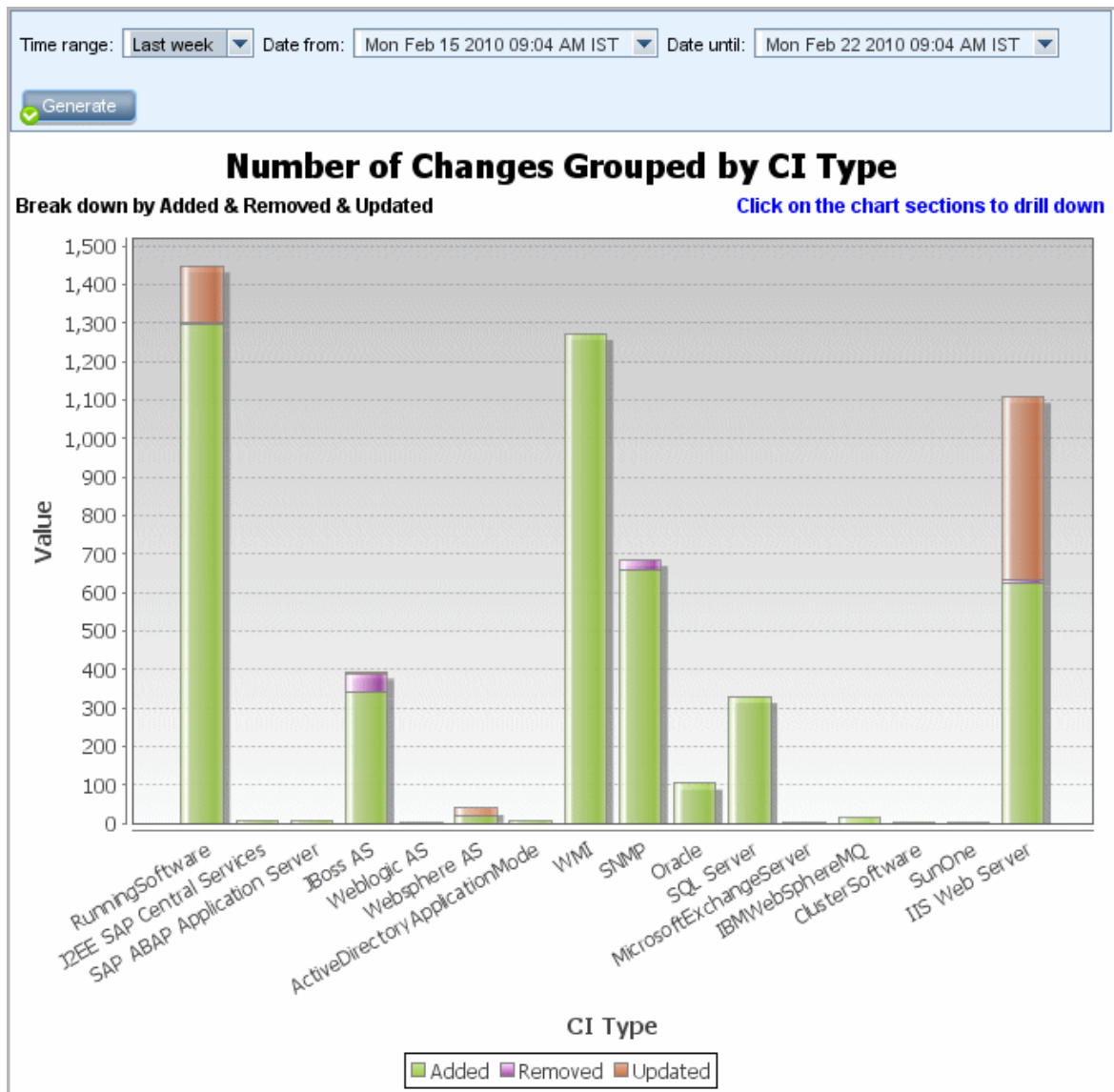

#### To access

Select **Managers > Modeling > Reports**. In the **Custom Reports** pane, do one of the following:

- Click the **Create New Report**  button and select **Changed Application Report**.
- Under **Change**:

	<ul style="list-style-type: none"> <li>◦ Double-click <b>Changed Application Report</b>.</li> <li>◦ Right-click <b>Changed Application Report</b> and select <b>Create New Report</b>.</li> <li>◦ Select <b>Changed Application Report</b>, and drag it onto the right pane.</li> </ul>
<b>Relevant tasks</b>	<a href="#">"How to Generate a Custom Report" on page 358</a>

User interface elements are described below (unlabeled elements are shown in angle brackets):

<b>UI Element (A-Z)</b>	<b>Description</b>
<b>&lt;Bar graph&gt;</b>	<p>Each bar represents a different application type. The colors in each bar represent the different types of changes that occurred in the application.</p> <p>Each color in the legend represents a different type of change. The CI type of each application is displayed under the relevant bar.</p> <p>When you hold the mouse over each bar, a tooltip indicates the number of changes that have occurred (such as the adding, removing, or updating of CIs, depending on the color), as well as the CI type the bar represents.</p> <p>Click the required color in the bar to drill down to see a list of the CIs that have changed.</p>
<b>&lt;Breadcrumbs&gt;</b>	<p>Displays the levels through which you have navigated to get to the current level. Appears horizontally across the top of the chart.</p> <p><b>Note:</b> Each level in the list of breadcrumbs is a clickable link.</p>
<b>&lt;Toolbar&gt;</b>	For details, see <a href="#">"Report Toolbar Options" on page 460</a> .
<b>Date from</b>	Configure a start date and time for the report.
<b>Date until</b>	Configure an end date and time for the report.
<b>Time range</b>	<p>Select a time frame over which to display the detected changes. The system automatically provides the starting and ending dates in the <b>Date from</b> and <b>Date until</b> boxes.</p> <p><b>Note:</b> If you select <b>Custom</b>, you can manually configure a start and end date in the <b>Date from</b> and <b>Date until</b> boxes.</p>

## Changed Views Report

This report displays the number of changes that occurred in a specific view within a defined period.

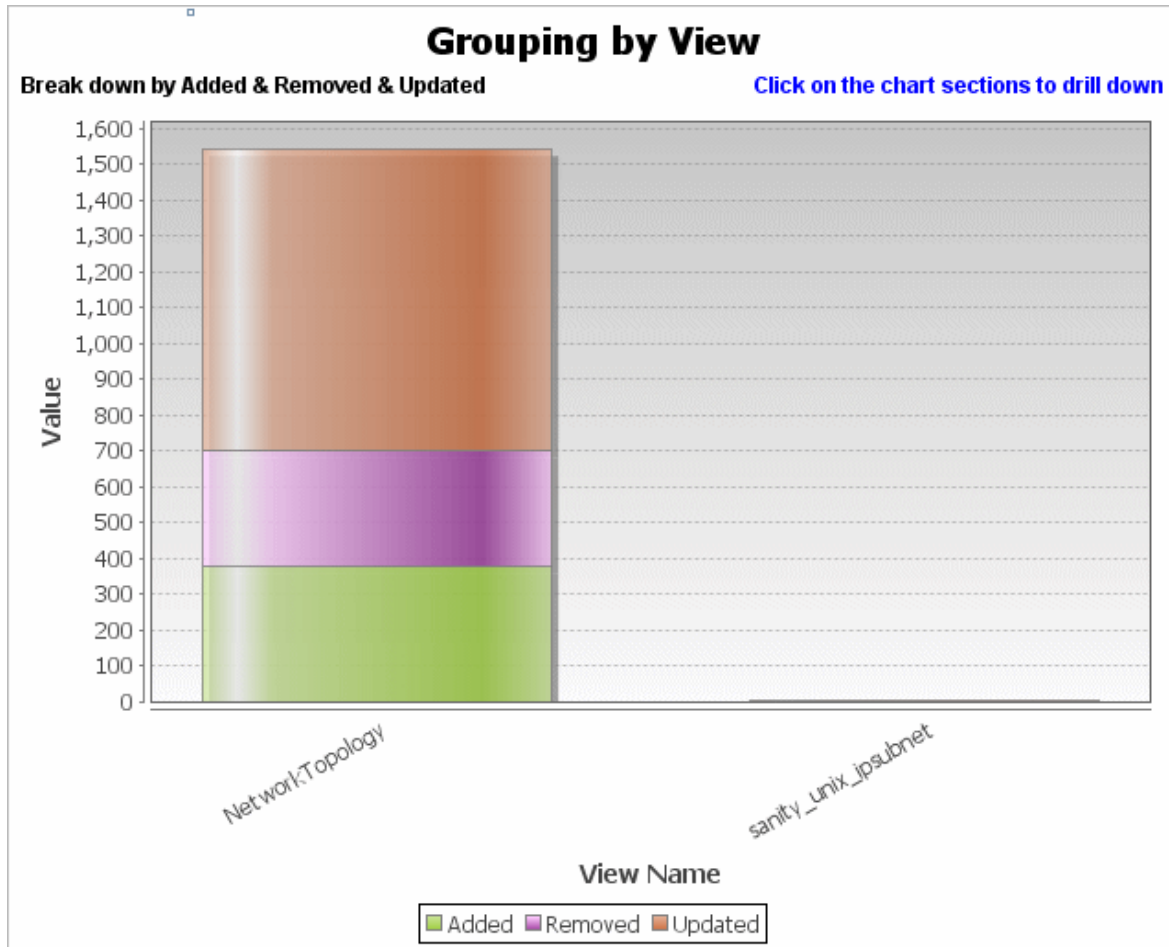

<b>To access</b>	<p>Select <b>Managers &gt; Modeling &gt; Reports</b>. In the <b>Custom Reports</b> pane, do one of the following:</p> <ul style="list-style-type: none"> <li>• Click the <b>Create New Report</b>  button and select <b>Changed Views Report</b>.</li> <li>• Under <b>Change</b>:             <ul style="list-style-type: none"> <li>◦ Double-click <b>Changed Views Report</b>.</li> <li>◦ Right-click <b>Changed Views Report</b> and select <b>Create New Report</b>.</li> <li>◦ Select <b>Changed Views Report</b>, and drag it onto the right pane.</li> </ul> </li> </ul>
<b>Relevant</b>	<a href="#">"How to Generate a Custom Report" on page 358</a>

<b>tasks</b>	
--------------	--

User interface elements are described below (unlabeled elements are shown in angle brackets):

<b>UI Element (A-Z)</b>	<b>Description</b>
<b>&lt;Bar graph&gt;</b>	<p>Each bar represents a different view. The name of each view is displayed under the relevant bar. The colors in each bar represent the different types of changes that occurred in the view (added, removed, or updated).</p> <p>When you hold the mouse over the relevant color in each bar, a tooltip indicates the name of the view, the change type, and the number of CI instances that changed in the view.</p> <p>See the legend to verify the change type each color represents.</p> <p>If snapshots were taken of a view at different times, you can click a bar to open the Compare Views by Snapshots dialog box and display the differences between the views. For details, see <a href="#">"Compare Snapshots Report" on page 395</a>.</p> <div style="background-color: #f0f0f0; padding: 5px; margin-top: 10px;"> <p><b>Note:</b> Only views with changes that reflect the differences between two snapshots, one taken before the <b>Date from</b> date (or, if not available, then after the <b>Date from</b> date) and another snapshot taken before the <b>Date until</b> date in the Changed Views report appear in the report.</p> </div>
<b>&lt;Toolbar&gt;</b>	For details, see <a href="#">"Report Toolbar Options" on page 460</a> .
<b>Date from</b>	Configure a start date and time for the report.
<b>Date until</b>	Configure an end date and time for the report.
<b>Time range</b>	<p>Select a time frame over which to display the changes. The system automatically provides the starting and ending dates in the <b>Date from</b> and <b>Date until</b> boxes.</p> <div style="background-color: #f0f0f0; padding: 5px; margin-top: 10px;"> <p><b>Note:</b> If you select <b>Custom</b>, you can manually configure a starting and ending date in the <b>Date from</b> and <b>Date until</b> boxes.</p> </div>

## CI Change Report

The CI Change report enables you to view and analyze the actual changes made to a specific CI and its children. This can help with possible troubleshooting issues related to this CI. For example, you may be able to trace the cause of the problem to changes in the CI. Alternatively, the source of the

troubleshooting issue could be related to expected changes which failed to occur. This report enables you to view CI attribute changes, as well as CIs that were added to or removed from a CI and its children.

The screenshot shows the configuration and results of a CI Change Report. At the top, the 'Time range' is set to 'Last month', with 'Date from' at 9/26/14 4:49 PM and 'Date until' at 10/26/14 3:49 PM. The 'Selected CIs' field contains 'labm3it58'. The 'Include information based on' section has 'View' selected over 'CMDB'. Both 'CI changes' and 'Relationship changes' are checked. A 'Generate' button is visible. Below this, there are tabs for 'CI Changes' and 'Relationship Changes'. A 'Show CI instances of' dropdown is set to 'Windows (3)'. The main table displays the following data:

Display Label	Class Name	Attribute Name	...	...	Change Date	Changer
labm3it58	Windows	root_iconproperties			Tue Oct 21 2014 04:09 PM IDT	Recalculate attribute
labm3it58	Windows	root_iconproperties			Tue Oct 21 2014 04:09 PM IDT	Recalculate attribute
labm3it58	Windows	root_iconproperties			Tue Oct 21 2014 04:09 PM IDT	Recalculate attribute

**To access**

Select **Managers > Modeling > Reports**. In the **Custom Reports** pane, do one of the following:

- Click the **Create New Report**  button and select **CI Change Report**.
- Under **Change**:
  - Double-click **CI Change Report**.
  - Right-click **CI Change Report** and select **Create New Report**.
  - Select **CI Change Report**, and drag it onto the right pane.

**Important information**

Only those CIs whose CIs whose properties are marked as either **Managed** or **Comparable** appear in the report. For details, see ["Add/Edit Attribute Dialog Box" on page 497](#).

CI Change reports display:

- Changes that occurred in a selected CI and all children of the CI that are related by the relationship specified in the **Change Report link name** infrastructure setting. The default value of this setting is an empty value, **(managed\_relationship)**, that enables you to track changes of all relationship attributes that are not marked as **Not Tracked in History**.  
To change the CIs displayed in the generated report, go to **Managers > Administration > Infrastructure Settings Manager** and edit the following settings:
  - Select **Change Report link name** to retrieve CIs that are linked by the selected

	<p>calculated relationship. Change the value of the setting to the name of the relationship as it appears in the <b>Name</b> box (not the <b>Display Name</b> box) in the Details page of the selected relationship in the CI Type Manager. For details, see <a href="#">"Details Page" on page 507</a>. If empty the class name is considered to be <b>managed_relationship</b>.</p> <ul style="list-style-type: none"> <li>◦ Select <b>Change Report link qualifier</b> to retrieve CIs that are defined with a qualifier. Change the value of the setting to the name of the required qualifier. For information about qualifiers, see <a href="#">"Qualifiers Page" on page 512</a>. If empty the qualifier is considered to be <b>Container</b>.</li> <li>• CIs with a <b>Composition</b> relationship that were added to, or removed from, a CI.</li> </ul> <p><b>Note:</b> In a multi-tenancy environment, the CI Change report only displays changes that are relevant to the tenants associated with your <b>View CIs</b> permission. However, <b>Remove CI/relationship</b> events that occurred before an upgrade to UCMDB version 10.01 are displayed independent of the tenants associated with the <b>View CIs</b> permission.</p>
<b>Relevant tasks</b>	<a href="#">"How to Generate a Custom Report" on page 358</a>

User interface elements are described below:

<b>UI Element (A-Z)</b>	<b>Description</b>
<b>Date from</b>	Configure a start date and time for the report.
<b>Date until</b>	Configure an end date and time for the report.
<b>Include information based on</b>	<p>Select one of the following:</p> <ul style="list-style-type: none"> <li>• <b>CMDB</b>. Display the changes that occurred to the CI and its children in the entire CMDB.</li> <li>• <b>View</b>. Display the changes that occurred to the CI and its children in the selected view.</li> </ul>
<b>Selected CIs</b>	<p>Select the required CIs. Opens the Select CI/View dialog box. For details, see <a href="#">"Working with the CI Selector" on page 130</a>.</p> <p>You can choose to display only CI changes, only Relationship changes, or both in the results.</p>
<b>Time range</b>	Select a time frame over which to display the changes. The system automatically

UI Element (A-Z)	Description
	<p>provides the starting and ending dates in the <b>Date from</b> and <b>Date until</b> boxes.</p> <p><b>Note:</b> If you select <b>Custom</b>, you can manually configure a starting and ending date in the <b>Date from</b> and <b>Date until</b> boxes.</p>

### CI Changes Tab

<b>Important Information</b>	To view the change history of a CI, right-click anywhere in the row of the required CI and select <b>CI History</b> .
------------------------------	---

User interface elements are described below (unlabeled elements are shown in angle brackets):

UI Element (A-Z)	Description
<Toolbar>	For details, see <a href="#">"Report Toolbar Options" on page 460</a> .
<Shortcut menu>	For details, see <a href="#">"IT Universe Manager Shortcut Menu" on page 235</a> .
<b>Attribute Name</b>	The name of the CI attribute that was changed.
<b>Change Date</b>	The date at which the change occurred.
<b>Changer</b>	The name of the user that manually modified the CI's property, or the name of the Data Flow Probe that automatically discovered a change made to the CI's property.
<b>Class Name</b>	The CI type of the changed CI.
<b>Display Label</b>	<p>The label of the path from the root to the CI.</p> <p>A backslash (\) in a CI name indicates a parent-child relationship with the format: &lt;parent_CI&gt;\&lt;child_CI&gt;. For example, the entry 16.59.63.0\Windows provides change information for the Windows CI that is the child of the 16.59.63.0 CI.</p>
<b>New Value</b>	The new value of the CI attribute.
<b>Old Value</b>	The previous value of the CI attribute (before the change).

## Relationship Changes Tab

<b>Important Information</b>	To view the change history of a CI, right-click anywhere in the row of the required CI and select <b>CI History</b> .
------------------------------	---

User interface elements are described below (unlabeled elements are shown in angle brackets):

UI Element (A-Z)	Description
<Shortcut menu>	For details, <a href="#">"IT Universe Manager Shortcut Menu" on page 235</a> .
<Toolbar>	For details, see <a href="#">"Report Toolbar Options" on page 460</a> .
<b>Change Date</b>	The date at which the update was performed.
<b>Changer</b>	The name of the user that manually modified the CI's property, or the name of the Data Flow Probe that automatically discovered a change made to the CI's property.
<b>Container Label</b>	The label of the path from the root to the container CI.  A backslash (\) in a CI name indicates a parent-child relationship with the format: <parent_CI>\<child_CI>. For example, the entry 16.59.63.0\Windows provides change information for the Windows CI that is the child of the dancer.hp.com CI.
<b>Event Type</b>	You can have one of the following values: <ul style="list-style-type: none"> <li>• <b>Add Related CI.</b> A contained CI was added to the container CI using a <b>Composition</b> relationship.</li> <li>• <b>Remove Related CI.</b> A contained CI that was linked to a container CI using a <b>Composition</b> was removed.</li> </ul>
<b>Link Type</b>	The type of the relationship.
<b>New Value</b>	The new value of the relationship attribute.
<b>Old Value</b>	The previous value of the relationship attribute (before the change).
<b>Related Label</b>	The label of the path from the root to the contained CI.
<b>Relationship Attribute</b>	The name of the relationship attribute that was changed.



## CMDB Utilization Report

This report displays general CMDB statistics. For example, the statistics can include the number of Impact rules created, how many CIs are contained in the CMDB, or how many snapshots have been taken.

Name	Value
— CIs and Relationships	11
— Views and Reports	0
— Enrichment Rules	26
— Correlation Rules	13
— Snapshots	0
— Connected users	4
— Running Discovery Jobs	0

<b>To access</b>	Select <b>Managers &gt; Modeling &gt; Reports</b> . In the <b>Custom Reports</b> pane, do one of the following: <ul style="list-style-type: none"> <li>• Click the <b>Create New Report</b>  button and select <b>CMDB Utilization Report</b>.</li> <li>• Under <b>General</b>:                         <ul style="list-style-type: none"> <li>◦ Double-click <b>CMDB Utilization Report</b>.</li> <li>◦ Right-click <b>CMDB Utilization Report</b> and select <b>Create New Report</b>.</li> <li>◦ Select <b>CMDB Utilization Report</b>, and drag it onto the right pane.</li> </ul> </li> </ul>
<b>Relevant tasks</b>	<a href="#">"How to Generate a Custom Report" on page 358</a>

User interface elements are described below (unlabeled elements are shown in angle brackets>):

UI Element (A-Z)	Description
<Toolbar>	For details, see <a href="#">"Report Toolbar Options" on page 460</a> .
<b>Name</b>	The name of the CMDB statistic.
<b>Value</b>	The number of instances for the CMDB statistic found in the system.

## Compare Archives Report

This report enables you to compare two archived reports or an archived report to the current version of the report.

Available Archives	Name	Time
<input checked="" type="checkbox"/>	Current	Current
<input checked="" type="checkbox"/>	Weekly Status	Wed Dec 7 2011 01:57 PM IST
<input type="checkbox"/>	2:00 PM Dec 7	Wed Dec 7 2011 01:53 PM IST

Legend: Contains An Updated Item Deleted Item New Item Updated Item

**Weekly Status (Wed Dec 7 2011 01:57 PM IST)** Report with archives

- LABM3AMDB39
- LABM3AMDB40
- LABM3AMDB41
- LABM3FTRND17
- LABM3LT60
- LABM3MAMDB03
- LABM3PCOEDB06
- LABM3PCOEDB17
- LABM3PCOEDB18
- LABM3PCOEDB19
- LABM3QC52
- m3-cnbf11
- mydvm0071
- mydvm0073
- mydvm0074
- mydvm0077
- mydvm0078
- sis11f920
- ucmdb903f9201
- vmamqa354
- vmamqa360

**Server Network**

- labm3amdb39
- LABM3AMDB40
- LABM3AMDB41
- LABM3FTRND17
- LABM3LT60
- LABM3MAMDB03
- LABM3PCOEDB06
- LABM3PCOEDB18
- LABM3PCOEDB19
- LABM3QC52
- m3-cnbf11
- mydvm0071
- mydvm0073
- mydvm0074
- mydvm0077
- mydvm0078
- sis11f920
- ucmdb903f9201
- vmamqa360
- vmamqa361
- vmamqa362







**To access**









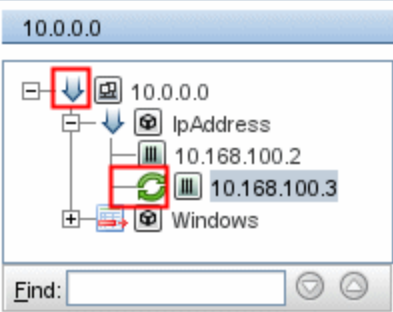

Select **Managers > Modeling > Reports**. In the **Custom Reports** pane, do one of the following:

- Click the **Create New Report** button and select **Compare Archives Report**.
- Under **Compliance**:

	<ul style="list-style-type: none"> <li>◦ Double-click <b>Compare Archives Report</b>.</li> <li>◦ Right-click <b>Compare Archives Report</b> and select <b>Create New Report</b>.</li> <li>◦ Select <b>Compare Archives Report</b>, and drag it onto the right pane.</li> </ul> <p>Alternatively, in the <b>Topology Reports</b> pane, select two archives of the same report and click the <b>Compare Report Archives</b>  button.</p>
<b>Important information</b>	<ul style="list-style-type: none"> <li>• The Compare Archives report is only available for topology reports.</li> <li>• You can compare the current version of a report to an archive of that report or two archives of the same report, but you cannot compare archives of different reports.</li> <li>• The only format available for previewing and exporting the Compare Archives report is the Excel format.</li> </ul>
<b>Relevant tasks</b>	<a href="#">"How to Generate a Custom Report" on page 358</a>

User interface elements are described below (unlabeled elements are shown in angle brackets>):

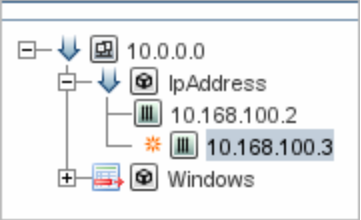
<b>UI Element (A-Z)</b>	<b>Description</b>
	<b>Expand All.</b> Expands the entire hierarchical tree structure of the CIs you selected.
	<b>Collapse All.</b> Collapses the hierarchical tree structure of the CIs you selected.
	<b>Previous Difference.</b> Finds the previous occurrence of an item marked as changed.
	<b>Next Difference.</b> Finds the next occurrence of an item marked as changed.
	<p><b>Show Configuration Files Differences.</b> Shows the difference between the content of the two configuration files. Configuration files use the <b>.xml</b>, <b>.txt</b> or <b>.ini</b> extensions.</p> <p>Select a CI of the CIT <b>Configuration File</b> in both panes and click the <b>Show Differences</b> button. A window opens displaying the differences (marked in blue) in the configuration files.</p>
	<b>Show Only Different CIs in Tree.</b> In the <Properties panes>, displays only the part of the tree structure containing CIs that do not match.
	<b>Show Only Different Attribute Values.</b> In the <Properties panes>, toggles between displaying all the attribute values of the selected CI or only the attribute values that have changed.

UI Element (A-Z)	Description						
	<p><b>Synchronize Selection.</b> Enables you to select a CI on one side and have its corresponding CI automatically selected on the other side.</p> <p>The default state for the <b>Synchronize Selection</b> button is selected. Deselecting this button allows you to select different CIs from each of the two trees. This enables you to compare two different CIs and see their different properties.</p>						
	<p><b>Contains An Updated Item.</b> Indicates that a CI's attribute value has changed. For example, a <b>Contains an Updated Item</b> icon is displayed next to the <b>10.0.0.0</b> CI in the figure below since the attribute of its child CI <b>10.168.100.3</b> icon has changed.</p>  <table border="1" data-bbox="412 1058 792 1171"> <thead> <tr> <th>Name</th> <th>Value</th> </tr> </thead> <tbody> <tr> <td>RoutingDomain</td> <td>Default Dom...</td> </tr> <tr> <td> P Network Mask</td> <td>255.0.0.0</td> </tr> </tbody> </table>	Name	Value	RoutingDomain	Default Dom...	 P Network Mask	255.0.0.0
Name	Value						
RoutingDomain	Default Dom...						
 P Network Mask	255.0.0.0						
	<p><b>Deleted Item.</b> Indicates that a CI has been deleted from the view.</p>						
	<p><b>New Item.</b> Indicates that a new CI has been added to the view.</p> 						
	<p><b>Updated Item.</b> Indicates that the attribute value of a CI has changed.</p> <p>For example, the figure below shows that the CIs <b>LABM3MAM16</b> displays the <b>Updated Item</b> icon because it was updated with a new <b>Version</b> value, as indicated by the <b>Show Only Different Attribute Values</b>  icons (see the <b>Name</b> and <b>Value</b> columns in the bottom panes underneath the tree structure).</p>						

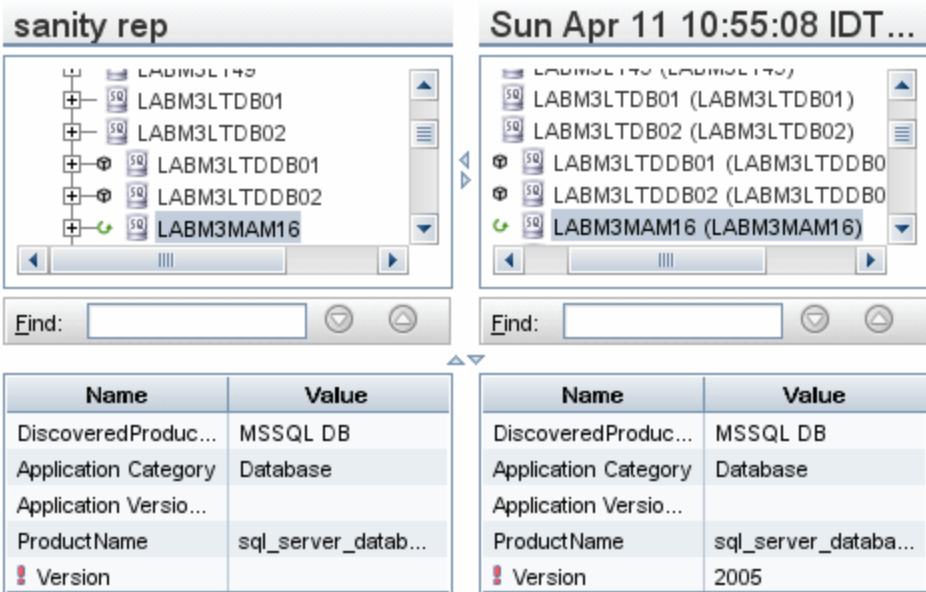
UI Element (A-Z)	Description
	
<b>&lt;Left and right panes&gt;</b>	<p>Displays a hierarchical tree structure of all the CIs in the view for each archive. The left side always represents the older of the two archives.</p>
<b>&lt;Properties pane&gt;</b>	<p>Displays the attributes of the selected CI.</p> <p>The Properties pane contains the following fields:</p> <ul style="list-style-type: none"> <li>• <b>Name.</b> Displays the name of the selected CI as defined in the CI's label.</li> <li>• <b>Value.</b> Displays the attribute value for the currently selected CI.</li> </ul>
<b>&lt;Shortcut Menu&gt;</b>	<p>Right-click a CI in the report to access the IT Universe Manager shortcut menu. For details, see <a href="#">"IT Universe Manager Shortcut Menu" on page 235.</a></p>
<b>&lt;Toolbar&gt;</b>	<p>For details, see <a href="#">"Report Toolbar Options" on page 460.</a></p>
<b>Available Archives</b>	<p>Displays the available archives of the report selected in the <b>Report with archives</b> field. Select the two archives you want to compare.</p> <p><b>Note:</b> Visible when the <b>Show Report Parameters</b> button is pressed.</p>
<b>Report with archives</b>	<p>Displays the name of the report whose archives you want to compare. Only reports with archives are displayed.</p> <p><b>Note:</b> Visible when the <b>Show Report Parameters</b> button is pressed.</p>

## Compare CIs Report

This report enables you to compare the hierarchies of two compound CIs. A compound CI is a CI that is linked to another CI by a relationship with the CONTAINER qualifier. You can display the compared CIs and their child CIs that appear in a selected view, or in the CMDB.

Compared CI:  ⋮

Compared CI:  ⋮

Mutual View:

Compare on:  View  CMDB

✔

Legend: ⊕ Contains An Updated Item ⊖ No Matching CI ↻ Updated Item

000129F42269

- ⊖ ⊕ 000129F42269
  - ⊖ ⊖ Interface
  - ⊖ ⊕ IpAddress
    - ⊖ ⊕ 16.44.49.38
    - ⊖ ⊕ SNMP
      - ⊖ ⊕ SNMP (000129F42269)

16.59.50.88 DefaultDomain

- ⊖ ⊕ 16.59.50.88 DefaultDomain
  - ⊖ ⊕ IpAddress
    - ⊖ ⊕ 16.59.50.88
    - ⊖ ⊕ SNMP
      - ⊖ ⊕ SNMP (16.59.50.88 Default)

Find:

Name	Value
DiscoveredProdu...	snmp
Application Categ...	
Application Versio...	
ProductName	
⚠ Candidate For ...	Sat May 1 2010 0...



Find:







Name	Value
DiscoveredProdu...	snmp
Application Categ...	
Application Versio...	
ProductName	
⚠ Candidate For ...	Sun May 2 2010 0...

**To access** Select **Managers > Modeling > IT Universe Manager**. Right-click a CI in the Topology Map and select **Compare CIs Report**



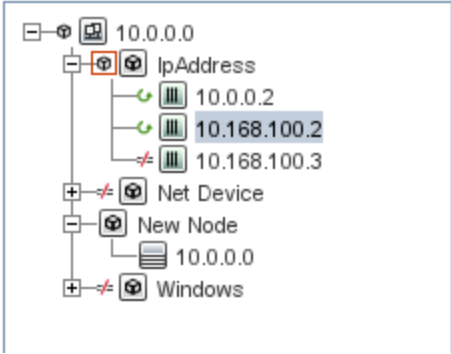

	<p>or</p> <p>Select <b>Managers &gt; Modeling &gt; Reports</b>. In the <b>Custom Reports</b> pane, do one of the following:</p> <ul style="list-style-type: none"> <li>• Click the <b>Create New Report</b>  button and select <b>Compare CIs Report</b>.</li> <li>• Under <b>Compliance</b>:             <ul style="list-style-type: none"> <li>◦ Double-click <b>Compare CIs Report</b>.</li> <li>◦ Right-click <b>Compare CIs Report</b> and select <b>Create New Report</b>.</li> <li>◦ Select <b>Compare CIs Report</b>, and drag it onto the right pane.</li> </ul> </li> </ul>
<p><b>Important information</b></p>	<ul style="list-style-type: none"> <li>• The Compare CIs page is divided into two panes. Each side displays a hierarchical tree structure of the CIs you selected. When you select a CI on one side, the corresponding CI on the other side is automatically selected, provided <b>Synchronize Selection</b> is pressed.</li> <li>• You can compare only two CIs of the same CI type or one of the CI type's children in the hierarchy.</li> <li>• The only format available for previewing and exporting the Compare CIs report is the Excel format.</li> </ul>
<p><b>Relevant tasks</b></p>	<ul style="list-style-type: none"> <li>• <a href="#">"How to Compare CIs" on page 359</a></li> <li>• <a href="#">"How to Generate a Custom Report" on page 358</a></li> </ul>

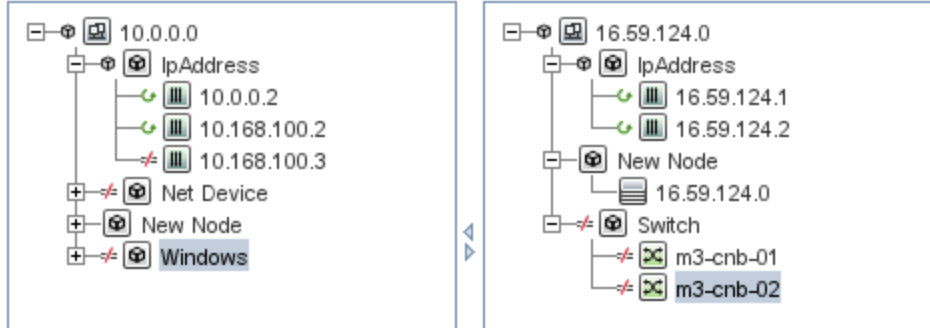
User interface elements are described below (unlabeled elements are shown in angle brackets>):

<p><b>UI Element (A-Z)</b></p>	<p><b>Description</b></p>
	<p><b>Previous Difference.</b> Finds the previous occurrence of an item marked as changed.</p>
	<p><b>Next Difference.</b> Finds the next occurrence of an item marked as changed.</p>
	<p><b>Show Configuration Files Differences.</b> Shows the difference between the content of the two configuration files. Configuration files use the <b>.xml</b>, <b>.txt</b> or <b>.ini</b> extensions.</p> <p>Select a CI of the CIT <b>Configuration File</b> in both panes and click the <b>Show Differences</b> button. A window opens displaying the differences (marked in blue) in the configuration files.</p>

UI Element (A-Z)	Description
	<p><b>Show Only Different CIs in Tree.</b> In the &lt;Properties panes&gt;, displays only the part of the tree structure containing CIs that do not match.</p>
	<p><b>Show Only Different Attribute Values.</b> In the &lt;Properties panes&gt;, toggles between displaying all the comparable attribute values of the selected CI or only the attribute values that are different.</p>
	<p><b>Synchronize Selection.</b> Enables you to select a CI on one side and have its corresponding CI automatically selected on the other side.</p> <p>The default state for the <b>Synchronize Selection</b> button is selected. Deselecting this button allows you to select different CIs from each of the two trees. This enables you to compare two different CIs and see their different properties.</p>
	<p><b>Contains An Updated Item.</b> Indicates that a CI's attribute value has changed. For example, a <b>Contains an Updated Item</b> icon is displayed next to the <b>IpAddress</b> CI in the figure below since the attribute of its child CI <b>10.168.100.2</b> icon has changed.</p> 
	<p><b>No Matching CI.</b> Indicates that a CI in one pane does not match any corresponding CI in the other pane.</p> <p>The following example displays the <b>No Matching CI</b> icon next to the <b>Windows</b> icon because it does not have a corresponding CI in the other pane.</p> 

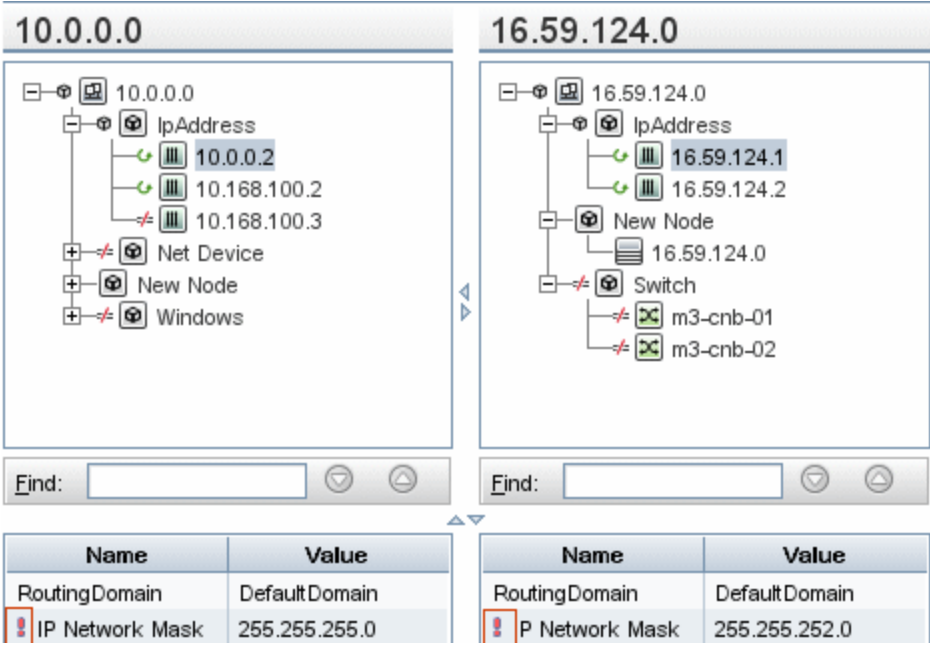

UI Element (A-Z)	Description												
	<p><b>Updated Item.</b> Indicates that the attribute value of a CI has changed.</p> <p>For example, the figure below shows that the CIs <b>10.0.0.2</b> and <b>16.59.124.1</b> display the <b>Updated Item</b> icon because they were updated with a new <b>IP Network Mask</b> value, as indicated by the <b>Show Only Different Attribute Values</b>  icons (see the <b>Name</b> and <b>Value</b> columns in the bottom panes underneath the tree structure).</p> <div style="display: flex; justify-content: space-around;"> <div style="border: 1px solid #ccc; padding: 5px; width: 45%;"> <p style="text-align: center; background-color: #f0f0f0; margin: -1px -1px 1px -1px;"><b>10.0.0.0</b></p>  <p style="font-size: small;">Find: <input type="text"/></p> <table border="1" style="width: 100%; border-collapse: collapse;"> <thead> <tr> <th style="width: 50%;">Name</th> <th style="width: 50%;">Value</th> </tr> </thead> <tbody> <tr> <td>RoutingDomain</td> <td>DefaultDomain</td> </tr> <tr> <td> IP Network Mask</td> <td>255.255.255.0</td> </tr> </tbody> </table> </div> <div style="border: 1px solid #ccc; padding: 5px; width: 45%;"> <p style="text-align: center; background-color: #f0f0f0; margin: -1px -1px 1px -1px;"><b>16.59.124.0</b></p>  <p style="font-size: small;">Find: <input type="text"/></p> <table border="1" style="width: 100%; border-collapse: collapse;"> <thead> <tr> <th style="width: 50%;">Name</th> <th style="width: 50%;">Value</th> </tr> </thead> <tbody> <tr> <td>RoutingDomain</td> <td>DefaultDomain</td> </tr> <tr> <td> IP Network Mask</td> <td>255.255.252.0</td> </tr> </tbody> </table> </div> </div>	Name	Value	RoutingDomain	DefaultDomain	IP Network Mask	255.255.255.0	Name	Value	RoutingDomain	DefaultDomain	IP Network Mask	255.255.252.0
Name	Value												
RoutingDomain	DefaultDomain												
IP Network Mask	255.255.255.0												
Name	Value												
RoutingDomain	DefaultDomain												
IP Network Mask	255.255.252.0												
	<p>Enables you to move to the next or previous result of the search for the string entered in the <b>Find</b> field.</p>												
<p><b>&lt;Toolbar&gt;</b></p>	<p>For details, see <a href="#">"Report Toolbar Options" on page 460.</a></p>												
<p><b>&lt;Shortcut menu&gt;</b></p>	<p>For details, see <a href="#">"IT Universe Manager Shortcut Menu" on page 235.</a></p>												
<p><b>&lt;Properties pane&gt;</b></p>	<p>Displays the attributes of the selected CI.</p> <p>The Properties pane contains the following fields:</p> <ul style="list-style-type: none"> <li>• <b>Name.</b> Displays the attribute name for the selected CI, which was marked as <b>Comparable</b> in the CI Type Manager.</li> <li>• <b>Value.</b> Displays the attribute value for the currently selected CI.</li> </ul>												
<p><b>&lt;Left and right panes&gt;</b></p>	<p>Displays a tree of the compared CIs and their child CIs that appear in the selected view or in the CMDB, depending on whether you selected the <b>View</b> or the <b>CMDB</b></p>												

UI Element (A-Z)	Description
	options.
<b>Compare in</b>	Select one of the following: <ul style="list-style-type: none"><li>• <b>CMDB.</b> Includes the selected CIs and their child CIs that appear in the entire CMDB.</li><li>• <b>View.</b> Includes the selected CIs and their child CIs that appear only in a specific view.</li></ul>
<b>Compared CI</b>	Enables you to select the two CIs you want to compare. Click  to open the CIs Selector dialog box. For details, see <a href="#">"CI Selector" on page 135</a> . The CI you select in the top box is displayed in the left pane and the CI you select in the bottom box is displayed in the right pane.
<b>Find</b>	<b>Find.</b> Enter a search name or a portion of a search name in the <b>Find</b> field to locate it in the list.
<b>Mutual View</b>	If both of the CIs you are comparing exist within the same view, the name of the view is displayed in this field. Otherwise, the field displays the words <b>No mutual view</b> .

## Compare Snapshots Report

This report enables you to compare two snapshots of a specific view taken at different times. It enables you to visualize the differences between the views by comparing the statuses of the view at the times the snapshots were taken.

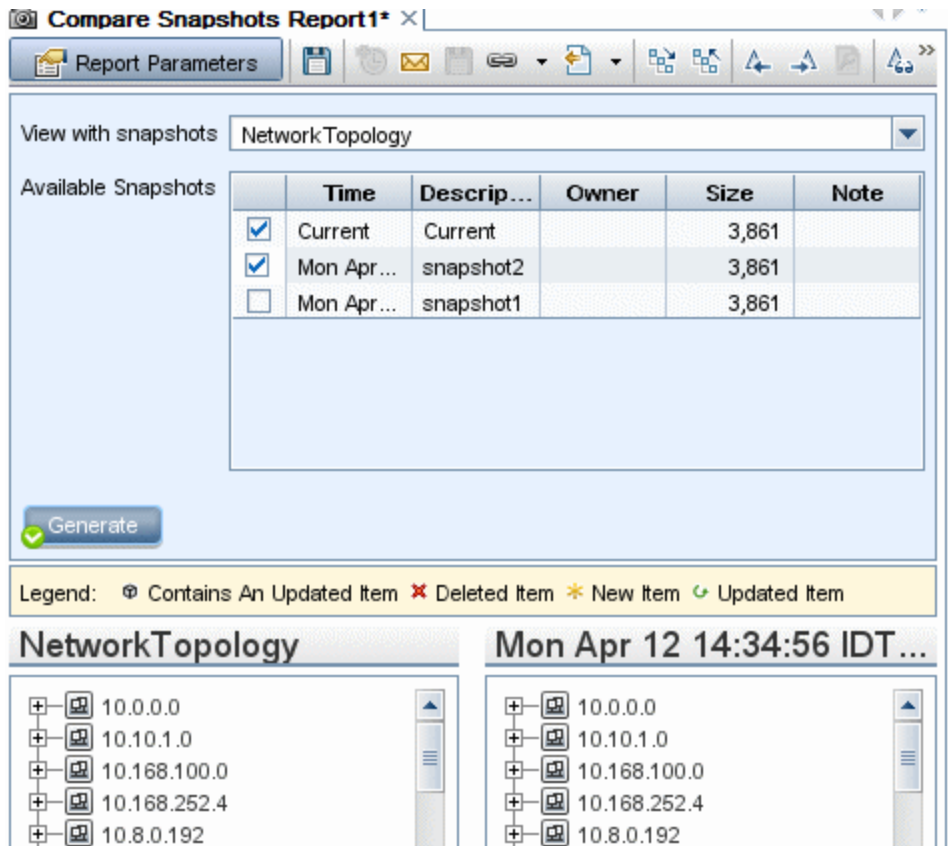





**To access**











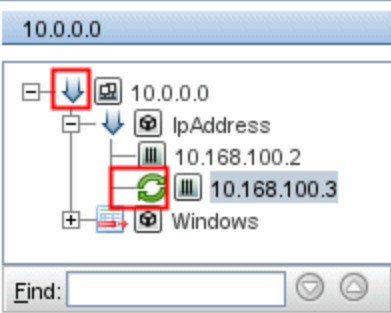

Select **Managers > Modeling > Reports**. In the **Custom Reports** pane, do one of the following:

- Click the **Create New Report** button and select **Compare Snapshots Report**.
- Under **Compliance**:
  - Double-click **Compare Snapshots Report**.
  - Right-click **Compare Snapshots Report** and select **Create New Report**.
  - Select **Compare Snapshots Report**, and drag it onto the right pane.

	<p><b>Note:</b> You can also take and compare snapshots in IT Universe Manager (for details, see <a href="#">"Save Snapshot Dialog Box" on page 249</a>).</p>
<b>Important information</b>	<ul style="list-style-type: none"> <li>You can compare a current snapshot to a previous snapshot or two snapshots taken in the past.</li> <li>You can define a schedule that takes snapshots of a specific view on a periodic basis and saves them. For details, see <a href="#">"Schedule Report/Snapshot Dialog Box" on page 444</a>.</li> <li>The only format available for previewing and exporting the Compare Snapshots report is the Excel format.</li> </ul> <p><b>Note:</b> Snapshots taken in a version prior to UCMDB 10.00 cannot be compared with snapshots taken in UCMDB 10.00 or higher.</p>
<b>Relevant tasks</b>	<ul style="list-style-type: none"> <li><a href="#">"How to Compare Snapshots" on page 360</a></li> <li><a href="#">"How to Generate a Custom Report" on page 358</a></li> </ul>
<b>See also</b>	<ul style="list-style-type: none"> <li><a href="#">"Save Snapshot Dialog Box" on page 249</a></li> <li><a href="#">"Schedule Report/Snapshot Dialog Box" on page 444</a></li> </ul>

User interface elements are described below (unlabeled elements are shown in angle brackets>):

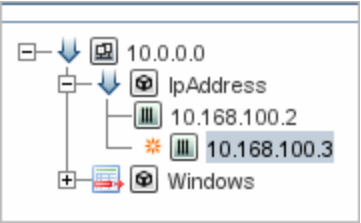
<b>UI Element (A-Z)</b>	<b>Description</b>
	<b>Expand All.</b> Expands the entire hierarchical tree structure of the CIs you selected.
	<b>Collapse All.</b> Collapses the hierarchical tree structure of the CIs you selected.
	<b>Previous Difference.</b> Finds the previous occurrence of an item marked as changed.
	<b>Next Difference.</b> Finds the next occurrence of an item marked as changed.
	<p><b>Show Configuration Files Differences.</b> Shows the difference between the content of the two configuration files. Configuration files use the <b>.xml</b>, <b>.txt</b> or <b>.ini</b> extensions.</p> <p>Select a CI of the CIT <b>Configuration File</b> in both panes and click the <b>Show Differences</b> button. A window opens displaying the differences (marked in blue) in the configuration files.</p>

UI Element (A-Z)	Description						
	<p><b>Show Only Different CIs in Tree.</b> In the &lt;Properties panes&gt;, displays only the part of the tree structure containing CIs that do not match.</p>						
	<p><b>Show Only Different Attribute Values.</b> In the &lt;Properties panes&gt;, toggles between displaying all the attribute values of the selected CI or only the attribute values that have changed.</p>						
	<p><b>Synchronize Selection.</b> Enables you to select a CI on one side and have its corresponding CI automatically selected on the other side.</p> <p>The default state for the <b>Synchronize Selection</b> button is selected. Deselecting this button allows you to select different CIs from each of the two trees. This enables you to compare two different CIs and see their different properties.</p>						
	<p><b>Contains An Updated Item.</b> Indicates that a CI's attribute value has changed. For example, a <b>Contains an Updated Item</b> icon is displayed next to the <b>10.0.0.0</b> CI in the figure below since the attribute of its child CI <b>10.168.100.3</b> icon has changed.</p>  <table border="1" data-bbox="412 1293 792 1409"> <thead> <tr> <th>Name</th> <th>Value</th> </tr> </thead> <tbody> <tr> <td>RoutingDomain</td> <td>Default Dom...</td> </tr> <tr> <td> P Network Mask</td> <td>255.0.0.0</td> </tr> </tbody> </table>	Name	Value	RoutingDomain	Default Dom...	 P Network Mask	255.0.0.0
Name	Value						
RoutingDomain	Default Dom...						
 P Network Mask	255.0.0.0						
	<p><b>Deleted Item.</b> Indicates that a CI has been deleted from the view.</p>						
	<p><b>New Item.</b> Indicates that a new CI has been added to the view.</p> 						
	<p><b>Updated Item.</b> Indicates that the attribute value of a CI has changed.</p>						

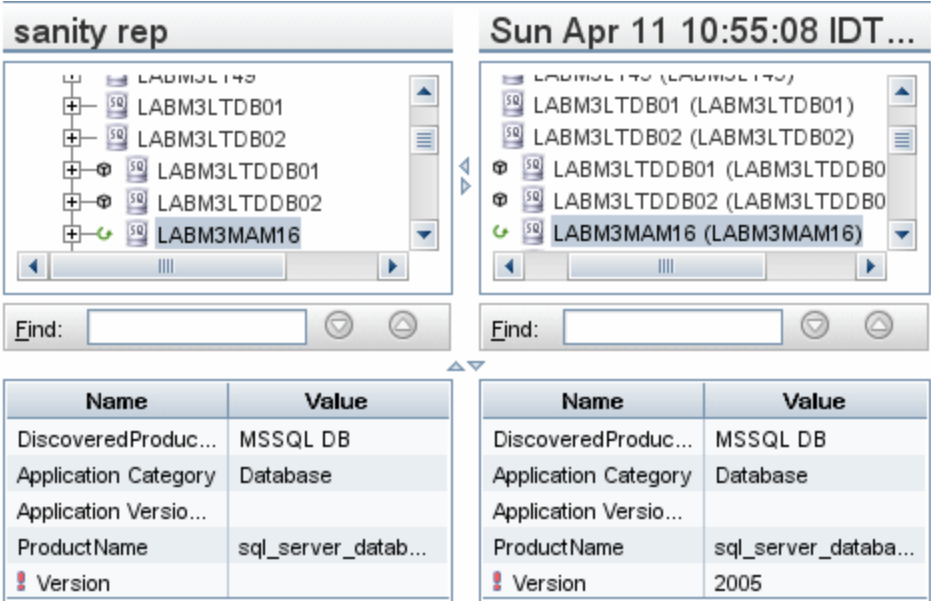
UI Element (A-Z)	Description
	<p>For example, the figure below shows that the CI <b>LABM3MAM16</b> displays the <b>Updated Item</b> icon because it was updated with a new <b>Version</b> value, as indicated by the <b>Show Only Different Attribute Values</b>  icons (see the <b>Name</b> and <b>Value</b> columns in the bottom panes underneath the tree structure).</p> 
<b>&lt;Left and right panes&gt;</b>	Displays a hierarchical tree structure of all the CIs in the view for that snapshot version. The left side always represents the older of the two versions.
<b>&lt;Properties pane&gt;</b>	<p>Displays the attributes of the selected CI.</p> <p>The Properties pane contains the following fields:</p> <ul style="list-style-type: none"> <li>• <b>Name.</b> Displays the name of the selected CI as defined in the CI's label.</li> <li>• <b>Value.</b> Displays the attribute value for the currently selected CI.</li> </ul>
<b>&lt;Shortcut Menu&gt;</b>	Right-click a CI in the report to access the IT Universe Manager shortcut menu. For details, see <a href="#">"IT Universe Manager Shortcut Menu" on page 235.</a>
<b>&lt;Toolbar&gt;</b>	For details, see <a href="#">"Report Toolbar Options" on page 460.</a>
<b>Available Snapshots</b>	<p>Displays the current status and previously saved snapshots of the view selected in the <b>View with Snapshots</b> field. Select the two snapshots you want to compare.</p> <p>By default, snapshots that have been empty for 3 months are hidden.</p>

UI Element (A-Z)	Description
	<p><b>Note:</b> Visible when the <b>Show Report Parameters</b> button is pressed.</p>
View with snapshots	<p>Displays the name of the view whose snapshots you want to compare. Only views for which snapshots have been taken are displayed.</p>
	<p><b>Note:</b> Visible when the <b>Show Report Parameters</b> button is pressed.</p>

## Configuration Manager Policy Report

This report displays Configuration Manager policy compliance level data.

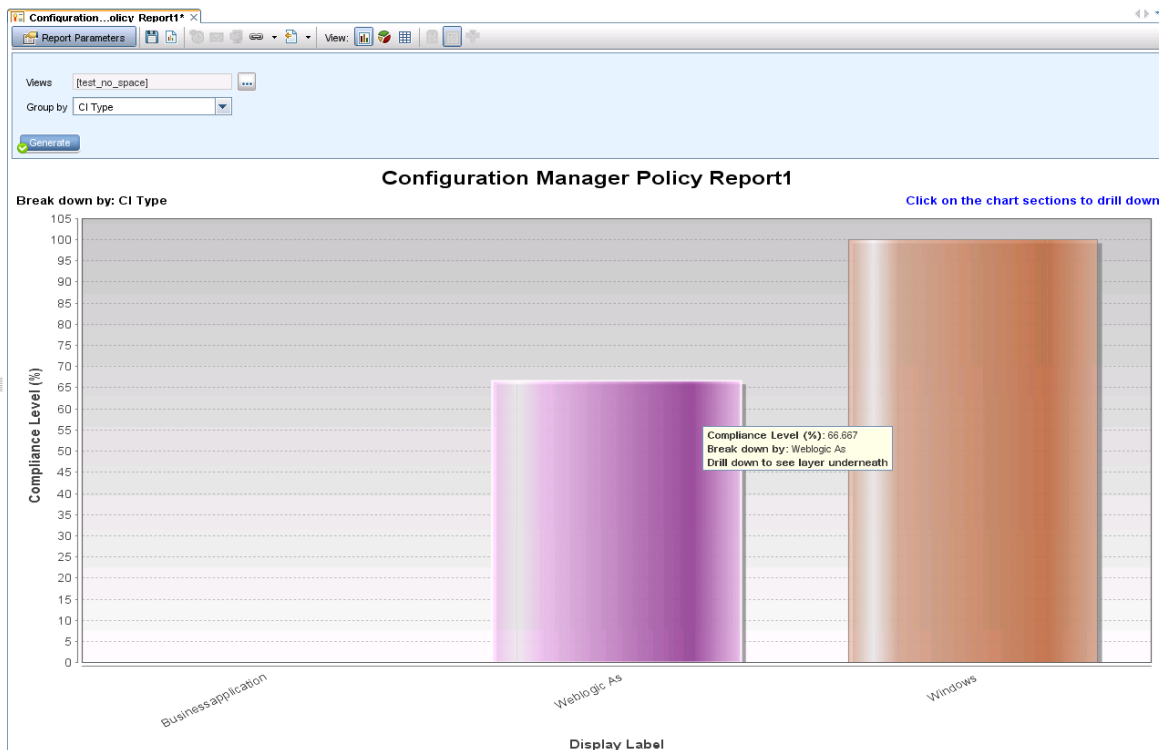

<p><b>To access</b></p>	<p>Select <b>Managers &gt; Modeling &gt; Reports</b>. In the <b>Custom Reports</b> pane, do one of the following:</p> <ul style="list-style-type: none"> <li>• Right-click <b>Configuration Manager Policy Report</b> and select <b>Create New Report</b>.</li> <li>• Double-click <b>Configuration Manager Policy Report</b>.</li> </ul>
-------------------------	---

	<ul style="list-style-type: none"> <li>• Select <b>Configuration Manager Policy Report</b> in the Custom Reports pane and drag it onto the right pane.</li> </ul>
<b>Important Information</b>	<p>This report only appears in the Custom Reports menu if Configuration Manager is running and is configured to work with UCMDB. The <b>Configuration Manager URL</b> setting in Infrastructure Settings Manager must contain the URL of the Configuration Manager application.</p> <p>To view the report, you must configure the CMPolicyAdapter in UCMDB. For details, see "Federation Workflow with UCMDB" in the <i>HP Universal CMDB Configuration Manager User Guide</i>.</p>
<b>Relevant tasks</b>	<p><a href="#">"How to Generate a Custom Report" on page 358</a></p>

User interface elements are described below (unlabeled elements are shown in angle brackets):

<b>UI Element (A-Z)</b>	<b>Description</b>
<b>&lt;Bar graph/ Pie chart&gt;</b>	<p>The report shows the average compliance level of the members of each group (according to the grouping selected under <b>Group by</b>) with their respective policies.</p> <p>You can click a group to drill down to the next level, which shows detailed information for the CIs in the group.</p>
<b>&lt;Breadcrumbs&gt;</b>	<p>Displays the levels through which you have navigated to get to the current level. Appears horizontally across the top of the chart.</p> <div style="background-color: #f0f0f0; padding: 5px; margin-top: 10px;"> <p><b>Note:</b> Each level in the list of breadcrumbs is a clickable link.</p> </div>
<b>&lt;Toolbar&gt;</b>	<p>For details, see <a href="#">"Report Toolbar Options" on page 460</a>.</p>
<b>Group by</b>	<p>Select an attribute from the drop-down list. The selected attribute determines how the output is grouped along the x-axis of the report. It also determines which columns appear in the second layer of the report.</p> <p>The available options are:</p> <ul style="list-style-type: none"> <li>• CI type</li> <li>• Classification</li> <li>• Layer</li> <li>• Policy name</li> <li>• Policy compliance status</li> </ul>



UI Element (A-Z)	Description
<b>Views</b>	Click the ellipsis button to open a view selector dialog box. Select the required views and click <b>OK</b> . You must select at least one view and no more than five.

## Database Breakdown Report

This report displays the breakdown of database types and versions. You can view all databases deployed in the system or the databases deployed at a specific location.

Include All Integration Points

Country or Province:

State:

City:

Databases Breakdown

### Databases Breakdown

Break down by Count

Click on the chart sections to drill down

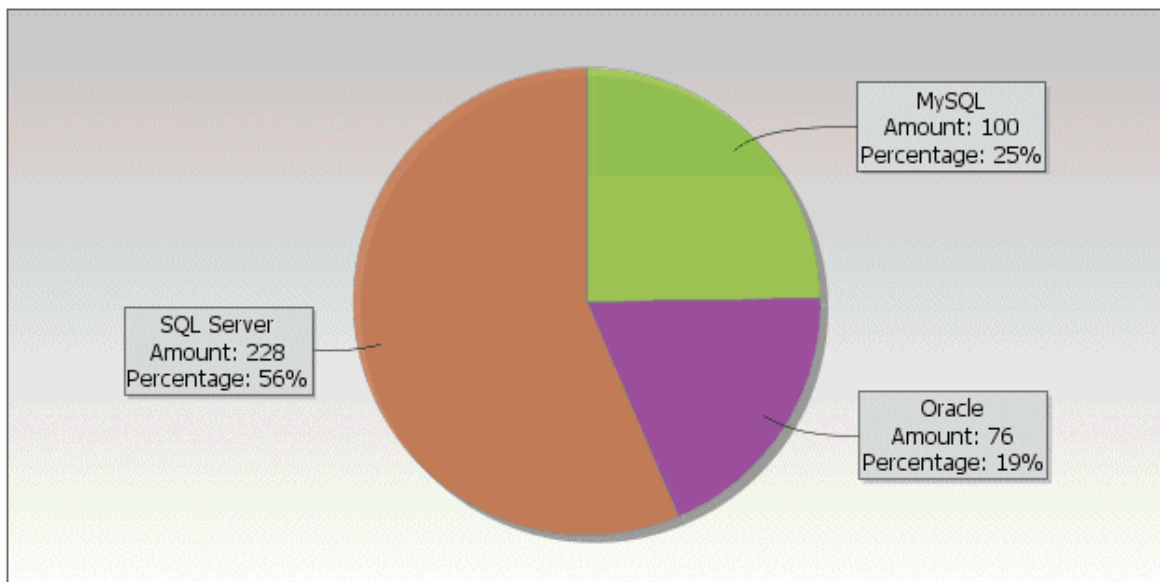

**To access**

Select **Managers > Modeling > Reports**. In the **Custom Reports** pane, do one of the following:

- Click the **Create New Report**  button and select **Database Breakdown Report**.

	<ul style="list-style-type: none"> <li>• Under <b>Breakdown</b>: <ul style="list-style-type: none"> <li>◦ Double-click <b>Database Breakdown Report</b>.</li> <li>◦ Right-click <b>Database Breakdown Report</b> and select <b>Create New Report</b>.</li> <li>◦ Select <b>Database Breakdown Report</b>, and drag it onto the right pane.</li> </ul> </li> </ul>
<b>Relevant tasks</b>	<a href="#">"How to Generate a Custom Report" on page 358</a>

User interface elements are described below (unlabeled elements are shown in angle brackets):

<b>UI Element (A-Z)</b>	<b>Description</b>
<b>&lt;Bar graph/Pie chart&gt;</b>	<p>Each segment of the pie chart/column in a bar graph represents a different database.</p> <p>Click a slice/bar to view the database sorted by version, and then click again to drill down to see the version information in table format.</p> <p>When you hold the mouse over each segment/bar, a tooltip indicates the name of the database, the number of CI instances found for each database, the percentage of the pie it represents (when viewing the information in pie chart format), and the CI type the slice/bar represents.</p> <p>The legend below the pie chart provides the name of each CI, and on the lower level, their versions.</p>
<b>&lt;Breadcrumbs&gt;</b>	<p>Displays the levels through which you have navigated to get to the current level. Appears horizontally across the top of the chart.</p> <p><b>Note:</b> Each level in the list of breadcrumbs is a clickable link.</p>
<b>&lt;Shortcut Menu&gt;</b>	<p>Drill down to the level of individual CIs and right-click a CI in the report to access the IT Universe Manager shortcut menu. For details, see <a href="#">"IT Universe Manager Shortcut Menu" on page 235</a>.</p>
<b>&lt;Toolbar&gt;</b>	<p>For details, see <a href="#">"Report Toolbar Options" on page 460</a>.</p>
<b>City</b>	<p>Select the city for which you want to view database breakdown data, or select <b>All</b> to show the breakdown for all cities.</p> <p><b>Note:</b> This is only relevant for CITs that contain data in the <b>City</b> attribute.</p>
<b>Country or</b>	<p>Select the country or province for which you want to view database breakdown</p>

<b>UI Element (A-Z)</b>	<b>Description</b>
<b>Province</b>	data, or select <b>All</b> to show the breakdown for all countries or provinces.  <b>Note:</b> This is only relevant for CITs that contain data in the <b>Country or Province</b> attribute.
<b>Include All Integration Points</b>	Select the check box to include federated CIs in the report. When the check box is cleared, only local CIs are included in the report.
<b>State</b>	Select the state for which you want to view database breakdown data, or select <b>All</b> to show the breakdown for all states.  <b>Note:</b> This is only relevant for CITs that contain data in the <b>State</b> attribute.

## Delete Candidates Report

This report displays the CITs and relationships that were deleted within a defined period, and the ones that are about to be deleted.

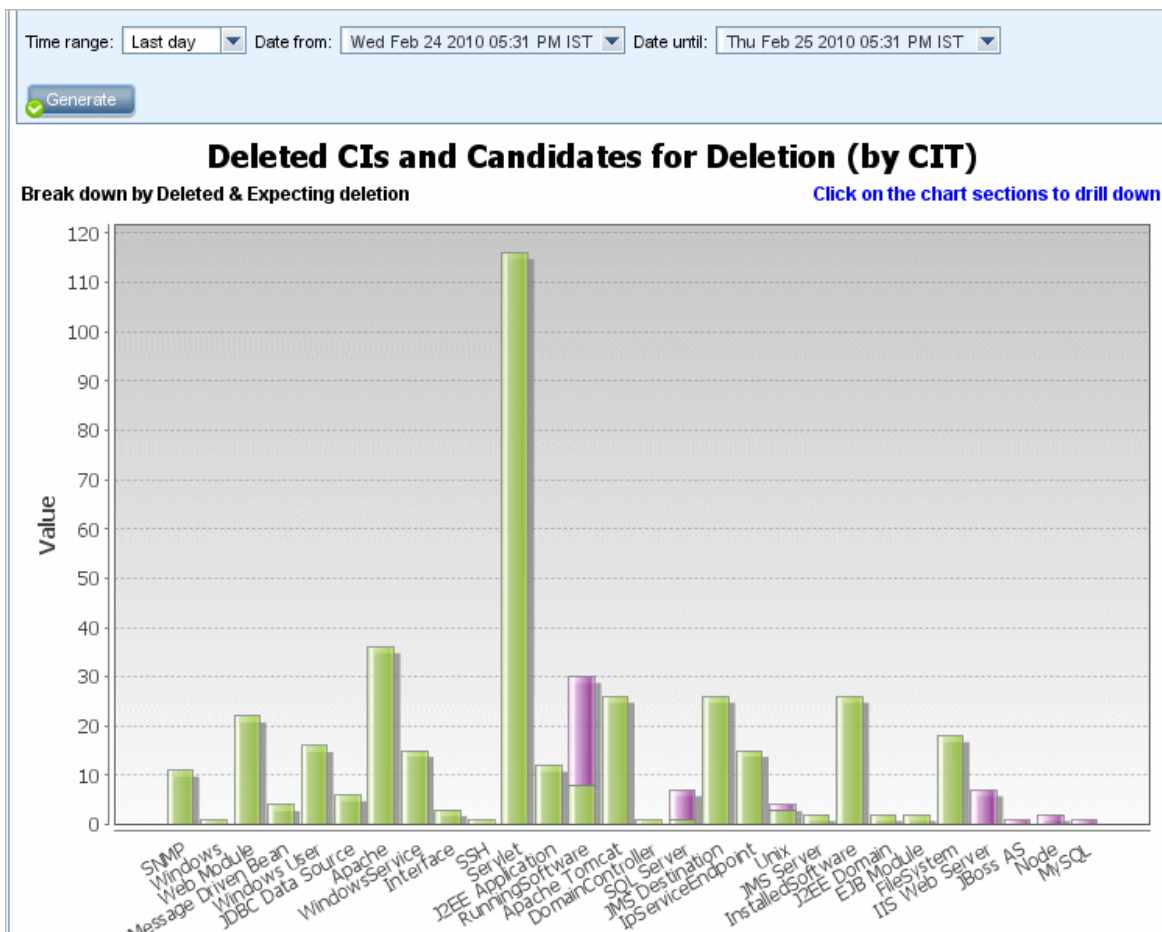

**To access**

Select **Managers > Modeling > Reports**. In the **Custom Reports** pane, do one of the following:

- Click the **Create New Report**  button and select **Delete Candidates Report**.
- Under **General**:
  - Double-click **Delete Candidates Report**.
  - Right-click **Delete Candidates Report** and select **Create New Report**.
  - Select **Delete Candidates Report**, and drag it onto the right pane.

<b>Relevant tasks</b>	<a href="#">"How to Generate a Custom Report" on page 358</a>
-----------------------	---

User interface elements are described below (unlabeled elements are shown in angle brackets):

<b>UI Element (A-Z)</b>	<b>Description</b>
<b>&lt;Bar graph&gt;</b>	<p>Each segment of the column in a bar graph represents a CIT of a CI or a relationship.</p> <p>Click a bar to drill down to display the CITs and relationships that were deleted/are about to be deleted in table format.</p> <p>When you hold the mouse over the relevant color of each bar, a tooltip indicates the number of CIs and relationships that were deleted or the ones that are about to be deleted and the CI type the bar represents.</p> <p>The legend shows which color represents the CIs and relationships that were deleted, and which color represents those that are about to be deleted. The CIT of each CI or relationship is displayed underneath.</p>
<b>&lt;Toolbar&gt;</b>	For details, see <a href="#">"Report Toolbar Options" on page 460</a> .
<b>Date from</b>	Configure a start date and time for the report.
<b>Date until</b>	Configure an end date and time for the report.
<b>Time range</b>	<p>Select a time frame over which to display the detected changes. The system automatically provides the starting and ending dates in the <b>Date from</b> and <b>Date until</b> boxes.</p> <p><b>Note:</b> If you select <b>Custom</b>, you can manually configure a starting and ending date in the <b>Date from</b> and <b>Date until</b> boxes.</p>

## Dependency Report

This report enables you to generate a list of all the relationships of the type **Dependency** that connect between servers in the selected view, or between the servers in the CMDB and the servers within the selected view.

The report includes relationships that:

- Exist between databases and clients
- Exist between clients and servers
- Are created as a result of an MQ connection

View: Weblogic\_To... ... Include information based on  CMDB  View

Generate

Node	Relationship	Counter	Clients
DR3	Talk	2	[DR3, DR3]
ilo-labm3amrddb06.devlab.ad	Talk	2	[ilo-labm3amrddb06.devlab.ad, ilo-labm3amrddb06.devlab.ad]
VMAMRND91	Talk	2	[VMAMRND91, VMAMRND91]
LABM3AM202	Talk	2	[LABM3AM202, LABM3AM202]
LABM2AM31	Talk	2	[LABM2AM31, LABM2AM31]
ilo-illabesx23.devlab.ad	Talk	2	[ilo-illabesx23.devlab.ad, ilo-illabesx23.devlab.ad]
ilo-labm3erp01.devlab.ad	Talk	2	[ilo-labm3erp01.devlab.ad, ilo-labm3erp01.devlab.ad]
VMFTRND27	Talk	2	[VMFTRND27, VMFTRND27]
ilo-labm3ccm29.devlab.ad	Talk	2	[ilo-labm3ccm29.devlab.ad, ilo-labm3ccm29.devlab.ad]
ilogb8920rfc6.devlab.ad	Talk	2	[ilogb8920rfc6.devlab.ad, ilogb8920rfc6.devlab.ad]
ilo-illabbac011.devlab.ad	Talk	2	[ilo-illabbac011.devlab.ad, ilo-illabbac011.devlab.ad]
ilo-labm3amrnd57.devlab.ad	Talk	2	[ilo-labm3amrnd57.devlab.ad, ilo-labm3amrnd57.devlab.ad]
ilo-labm3am235.devlab.ad	Talk	2	[ilo-labm3am235.devlab.ad, ilo-labm3am235.devlab.ad]

<b>To access</b>	<p>Select <b>Managers &gt; Modeling &gt; Reports</b>. In the <b>Custom Reports</b> pane, do one of the following:</p> <ul style="list-style-type: none"> <li>• Click the <b>Create New Report</b>  button and select <b>Dependency Report</b>.</li> <li>• Under <b>General</b>: <ul style="list-style-type: none"> <li>◦ Double-click <b>Dependency Report</b>.</li> <li>◦ Right-click <b>Dependency Report</b> and select <b>Create New Report</b>.</li> <li>◦ Select <b>Dependency Report</b>, and drag it onto the right pane.</li> </ul> </li> </ul>
<b>Important information</b>	You can create new TQL queries in Enrichment Manager using the <b>Dependency</b> relationship to describe the connection between nodes. Every new <b>Dependency</b> relationship that is used appears in the Dependency report.
<b>Relevant tasks</b>	<a href="#">"How to Generate a Custom Report" on page 358</a>

User interface elements are described below (unlabeled elements are shown in angle brackets>):

UI Element (A-Z)	Description
<Shortcut menu>	For details, see <a href="#">"IT Universe Manager Shortcut Menu" on page 235.</a>
<Toolbar>	For details, see <a href="#">"Report Toolbar Options" on page 460.</a>
<b>Include information based on</b>	Select one of the following: <ul style="list-style-type: none"> <li>• <b>CMDB.</b> Display all the servers in the CMDB that are dependent on the servers in the selected view.</li> <li>• <b>View.</b> Display all the dependencies between the servers in the selected view.</li> </ul>
<b>View</b>	Select the required view.

The generated report includes the following elements (listed alphabetically):

UI Element (A-Z)	Description
<b>Clients</b>	The list of clients that are linked to the servers.
<b>Counter</b>	The number of clients to which the server is connected.
<b>Node</b>	The servers in the selected view.
<b>Relationship</b>	The display label of the relationship in the Topology Map.

## Discovery Errors Report

This report enables you to uncover specific problems that Data Flow Management encounters during a run, for example, incorrect credentials.

<b>To access</b>	<p>Select <b>Managers &gt; Modeling &gt; Reports</b>. In the <b>Custom Reports</b> pane, do one of the following:</p> <ul style="list-style-type: none"> <li>• Click the <b>Create New Report</b>  button and select <b>Discovery Errors Report</b>.</li> <li>• Under <b>Discovery Status</b>: <ul style="list-style-type: none"> <li>◦ Double-click <b>Discovery Errors Report</b>.</li> <li>◦ Right-click <b>Discovery Errors Report</b> and select <b>Create New Report</b>.</li> <li>◦ Select <b>Discovery Errors Report</b>, and drag it onto the right pane.</li> </ul> </li> </ul>
------------------	--

<p><b>Important information</b></p>	<ul style="list-style-type: none"> <li>• Choose which columns to display by clicking the <b>Select Columns</b> button.</li> <li>• Hide a column by right-clicking its header and selecting <b>Remove Column</b>.</li> <li>• Hide empty columns by right-clicking a header and selecting <b>Remove Empty Columns</b>.</li> <li>• Change the order of columns by dragging and dropping a column header.</li> </ul> <p><b>Note:</b> The Discovery Errors report is only relevant for errors in jobs that are currently active.</p>
<p><b>See also</b></p>	<ul style="list-style-type: none"> <li>• "Discovery Progress Dialog Box" in the <i>HP Universal CMDB Data Flow Management Guide</i></li> <li>• "Error Messages Overview" in the <i>HP Universal CMDB Developer Reference Guide</i></li> </ul>

User interface elements are described below (unlabeled elements are shown in angle brackets):

<p><b>UI Element (A-Z)</b></p>	<p><b>Description</b></p>
<p><b>&lt;Shortcut Menu&gt;</b></p>	<p>Right-click a CI in the report to access the IT Universe Manager shortcut menu. For details, see <a href="#">"IT Universe Manager Shortcut Menu" on page 235</a>.</p>
<p><b>&lt;Toolbar&gt;</b></p>	<p>For details, see <a href="#">"Report Toolbar Options" on page 460</a>.</p>
<p><b>Discovery Module</b></p>	<p>Select the module for which to display errors. You can select all modules or specific modules.</p>
<p><b>Discovery Probe</b></p>	<p>Select a Data Flow Probe.</p>
<p><b>Generate</b></p>	<p>Click to generate a list of errors.</p>
<p><b>Severity</b></p>	<p>Select the types of error to display. For error definitions, see "Error Severity Levels" in the <i>HP Universal CMDB Developer Reference Guide</i>.</p> <p><b>Note:</b> You can select multiple error types.</p>
<p><b>Time range</b></p>	<p>Select a time frame over which to display the errors. The system automatically provides the start and end dates in the <b>Date from</b> and <b>Date until</b> boxes.</p>



UI Element (A-Z)	Description
	<p><b>Note:</b> If you select <b>Custom</b>, you can manually configure a start and end date in the <b>Date from</b> and <b>Date until</b> boxes.</p>

The generated report includes the following elements (listed alphabetically):

UI Element (A-Z)	Description
<b>CI Type</b>	The CIT of the trigger CI.
<b>Count</b>	The number of errors contained in the Error Summary group.
<b>Error Message</b>	The detailed error message.
<b>Error Summary</b>	<p>A brief summary of the error.</p> <p><b>Note:</b> Similar errors are grouped together. The count column shows the number of errors.</p>
<b>Job</b>	The job for which the error was reported.
<b>Probe</b>	The Data Flow Probe that reported the error.
<b>Related IPs</b>	IPs known to be related to the trigger CI.
<b>Related Node</b>	The node that is related to the trigger CI.
<b>Severity</b>	The error severity level (Warning, Error, Fatal Error).
<b>Time Error Reported</b>	The time the error was reported.
<b>Trigger CI</b>	The trigger CI on which the error was reported.

## Generic Breakdown Report

This report displays the breakdown of CI types by the following:

- The CITs grouped under the selected CIT in the CIT tree
- A CIT attribute

For more details about CI types, see ["CI Type Manager" on page 485](#).

Include All Integration Points

CIT to break down: ConfigurationItem

Break down By: CI Type

Then By: Created By

Then By: Allow CI Update

Generate

### Generic Breakdown Report1

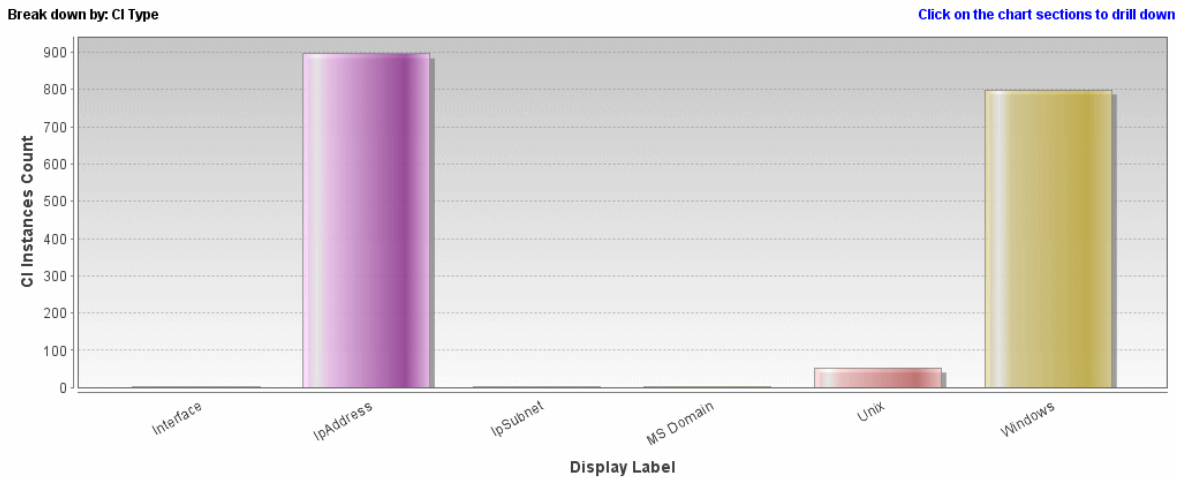

<b>To access</b>	<p>Select <b>Managers &gt; Modeling &gt; Reports</b>. In the <b>Custom Reports</b> pane, do one of the following:</p> <ul style="list-style-type: none"> <li>• Click the <b>Create New Report</b>  button and select <b>Generic Breakdown Report</b>.</li> <li>• Under <b>Breakdown</b>: <ul style="list-style-type: none"> <li>◦ Double-click <b>Generic Breakdown Report</b>.</li> <li>◦ Right-click <b>Generic Breakdown Report</b> and select <b>Create New Report</b>.</li> <li>◦ Select <b>Generic Breakdown Report</b>, and drag it onto the right pane.</li> </ul> </li> </ul>
<b>Relevant tasks</b>	<a href="#">"How to Generate a Custom Report" on page 358</a>

User interface elements are described below (unlabeled elements are shown in angle brackets>):

UI Element (A-Z)	Description
<Bar graph/Pie chart>	Each segment of the pie chart/column in a bar graph represents a CIT or a CIT attribute, depending on how that level has been broken down.

UI Element (A-Z)	Description
	<p>Click a slice/bar to drill down to the next level, if one has been defined. You can generate a report that has up to three different levels. You can also display the information in table format.</p> <p>When you hold the mouse over the relevant segment/bar, a tooltip indicates the number of CI instances found for that CIT or CIT attribute, the percentage of the pie it represents (when viewing the information in pie chart format), and the CIT or CIT attribute the slice/bar represents.</p>
<b>&lt;Breadcrumbs&gt;</b>	<p>Displays the levels through which you have navigated to get to the current level. Appears horizontally across the top of the chart.</p> <p><b>Note:</b> Each level in the list of breadcrumbs is a clickable link.</p>
<b>&lt;Shortcut Menu&gt;</b>	<p>Drill down to the level of individual CIs and right-click a CI in the report to access the IT Universe Manager shortcut menu. For details, see <a href="#">"IT Universe Manager Shortcut Menu" on page 235</a>.</p>
<b>&lt;Toolbar&gt;</b>	<p>For details, see <a href="#">"Report Toolbar Options" on page 460</a>.</p>
<b>Breakdown by</b>	<p>Select the required breakdown for the first level.</p>
<b>CIT to break down</b>	<p>The CIT whose instances are broken down by the selected attributes.</p>
<b>Include All Integration Points</b>	<p>Select the check box to include federated CIs in the report. When the check box is cleared, only local CIs are included in the report.</p>
<b>Then by</b>	<p>(Optional) Select the required breakdown for the second and third levels.</p>

## Gold Master Report

This report compares one or more CIs to another CI that has been designated as a Gold Master, and specifies which of the compared CIs are configured differently from the Gold Master CI.

The report compares the attribute values of the Gold Master CIs to the attribute values of the Compared CI of the same CIT.

**Note:**

- The Gold Master report only displays a CI attribute comparison if the values are different.
- Gold Master reports are not available for federated CIs.

If a section is empty, it means that all attribute values of the Gold Master CIs and the Compared CIs for that CIT are identical. In such a case, the attributes in the next layer in the subgraph are compared, and the next one, and so on.

Once the compared CIs in a layer are found to have different attributes, the Gold Master report does not continue the comparison of other layers in the subgraph for differences.

Master CI:  ⋮

Compared CIs:  ⋮ Exclude CI types:  ⋮

Display Identical Attribute Values

✔ Generate

Display Label	Attribute Name	Value in Goldmaster CI	Value in Compare
scdam036			
Windows	CI Instances Count	1	
labm3qcrnddb...	DiscoveredModel	ProLiant BL460c G1	none
labm3qcrnddb...	Windows Physical Memory Size	2094960	none
labm3qcrnddb...	SwapMemorySize	4095	none
labm3qcrnddb...	DomainName	devlab.ad	none
labm3qcrnddb...	MemorySize	2048	none
labm3qcrnddb...	DiscoveredVendor	HP	none
scdam075			
Windows	CI Instances Count	2	
labm3qcrnddb...	DiscoveredModel	ProLiant BL460c G1	none
labm3qcrnddb...	Windows Physical Memory Size	2094960	none
labm3qcrnddb...	SwapMemorySize	4095	4092
labm3qcrnddb...	DomainName	devlab.ad	none
labm3qcrnddb...	MemorySize	2048	4097
labm3qcrnddb...	DiscoveredVendor	HP	none

**To access**

Select **Managers > Modeling > Reports**. In the **Custom Reports** pane, do one of the following:

Click the **Create New Report**  button and select **Gold Master Report**.

Under **Compliance**:

- Double-click **Gold Master Report**.
- Right-click **Gold Master Report** and select **Create New Report**.

	<ul style="list-style-type: none"> <li>Select <b>Gold Master Report</b>, and drag it onto the right pane.</li> </ul>
<b>Important information</b>	Only attributes that have been assigned the <b>Comparable</b> qualifier in the CIT Manager can be compared. For details, see <a href="#">"CI Type Manager" on page 485</a> .
<b>Relevant tasks</b>	<a href="#">"How to Compare Snapshots" on page 360</a>



User interface elements are described below:

UI Element (A-Z)	Description
<Shortcut menu>	For details, see <a href="#">"IT Universe Manager Shortcut Menu" on page 235</a> .
<Toolbar>	For details, see <a href="#">"Report Toolbar Options" on page 460</a> .
<b>Attribute Name</b>	The name of the CI attribute.
<b>Compared CIs</b>	Enables you to select the CIs whose attribute values you want to compare to the Gold Master CI. Opens the CI Selector. For details, see <a href="#">"CI Selector" on page 135</a> .
<b>Display Identical Attribute Values</b>	<p>Select this check box if you want to include the compared CIs whose configuration is identical to that of the Gold Master CI.</p> <div style="background-color: #f0f0f0; padding: 5px; margin-top: 10px;"> <p><b>Note:</b> If you do not select this check box, the <b>Value in Gold Master CI</b> and <b>Value in Compared CI</b> columns of CIs with identical attribute values are empty.</p> </div>
<b>Display Label</b>	The display name of the Compared CI.
<b>Exclude CI types</b>	Select the CI types to exclude from the report.
<b>Master CI</b>	Enables you to select the CI you want to use as a Gold Master CI. Opens the CI Selector. For details, see <a href="#">"CI Selector" on page 135</a> .
<b>Value in Compared CI</b>	The value of the attribute in the Compared CI.
<b>Value in Gold Master CI</b>	The value of the attribute in the Gold Master CI.

## Hardware Component Summary Report

This report displays data for all the node elements of hardware types detected in the system.

Display Label	InterfaceDescription	MacAddress
e1000g0		0050568B66C9
e1000g0:1		
eth1	Advanced Micro Devices [AMD] 79c970 [PCnet32 LANCE]	005056AA0067
lo		
lo0		
Local Area Connection 2	Intel(R) PRO/1000 MT Network Connection #2	005056AA000A
Local Area Connection* 11	Teredo Tunneling Pseudo-Interface	020054564E01
Local Area Connection* 8	isatap.asiapacific.hpqcorp.net	
Local Area Connection* 9	6TO4 Adapter	
Loopback Pseudo-Interface 1	Software Loopback Interface 1	
Microsoft Tun Miniport Adapter	Microsoft Tun Miniport Adapter	020054564E01
virbr0		D6E8BA2AC73B

<p><b>To access</b></p>	<p>Select <b>Managers &gt; Modeling &gt; Reports</b>. In the <b>Custom Reports</b> pane, do one of the following:</p> <ul style="list-style-type: none"> <li>Click the <b>Create New Report</b>  button and select <b>Hardware Component Summary Report</b>.</li> <li>Under <b>Inventory</b>: <ul style="list-style-type: none"> <li>Double-click <b>Hardware Component Summary Report</b>.</li> <li>Right-click <b>Hardware Component Summary Report</b> and select <b>Create New Report</b>.</li> <li>Select <b>Hardware Component Summary Report</b>, and drag it onto the right pane.</li> </ul> </li> </ul>
<p><b>Important information</b></p>	<p>The top level of the report displays the number of elements for each device type. Click on a number to drill down to the next layer and view a list of the individual hardware components with detailed data.</p> <p>The hardware components displayed in the report include CPUs, disk devices, fans, hardware boards, I/O slots, interfaces, memory units, physical ports, power supplies, printers and SCSI adapters.</p> <p>Use the <b>Select Columns</b>  button to select the attributes to display in the report.</p>
<p><b>Relevant tasks</b></p>	<p><a href="#">"How to Generate a Custom Report" on page 358</a></p>

User interface elements are described below (unlabeled elements are shown in angle brackets>):

UI Element (A-Z)	Description
<Breadcrumbs>	Displays the levels through which you have navigated to get to the current level. Appears horizontally across the top of the chart.  <b>Note:</b> Each level in the list of breadcrumbs is a clickable link.
<Shortcut Menu>	Right-click a CI in the report to access the IT Universe Manager shortcut menu. For details, see <a href="#">"IT Universe Manager Shortcut Menu" on page 235</a> .
<Toolbar>	For details, see <a href="#">"Report Toolbar Options" on page 460</a> .

## Impact Analysis Report

This report displays a list of CIs that are impacted in the system as a result of simulated changes. For details, see ["Run Impact Analysis Dialog Box" on page 247](#).

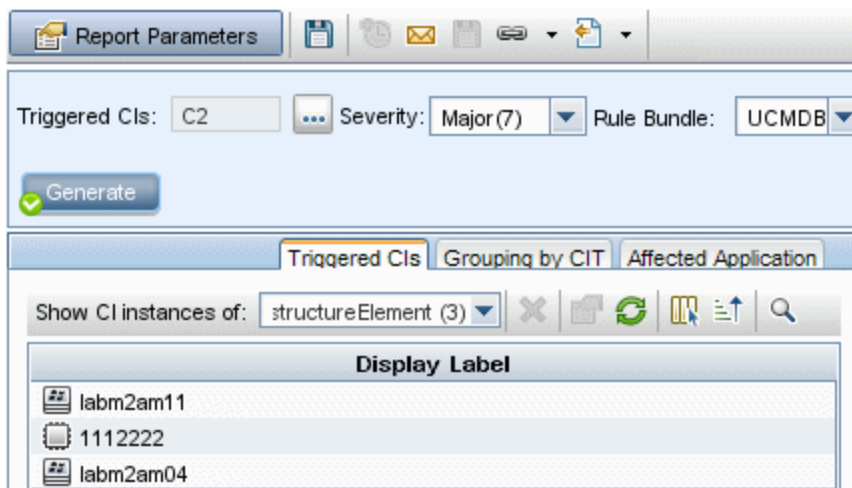

<b>To access</b>	<p>Select <b>Managers &gt; Modeling &gt; Reports</b>. In the <b>Custom Reports</b> pane, do one of the following:</p> <ul style="list-style-type: none"> <li>• Click the <b>Create New Report</b>  button and select <b>Impact Analysis Report</b>.</li> <li>• Under <b>General</b>:                     <ul style="list-style-type: none"> <li>◦ Double-click <b>Impact Analysis Report</b>.</li> <li>◦ Right-click <b>Impact Analysis Report</b> and select <b>Create New Report</b>.</li> <li>◦ Select <b>Impact Analysis Report</b>, and drag it onto the right pane.</li> </ul> </li> </ul>
------------------	---

<b>Relevant tasks</b>	<a href="#">"How to Generate a Custom Report" on page 358</a>
<b>See also</b>	<ul style="list-style-type: none"> <li>• <a href="#">"Impact Analysis Manager" on page 466</a></li> <li>• <a href="#">"Run Impact Analysis Dialog Box" on page 247</a></li> </ul>

User interface elements are described below (unlabeled elements are shown in angle brackets):

UI Element (A-Z)	Description
<Shortcut Menu>	Right-click a CI in the report to access the IT Universe Manager shortcut menu. For details, see <a href="#">"IT Universe Manager Shortcut Menu" on page 235</a> .
<Toolbar>	For details, see <a href="#">"Report Toolbar Options" on page 460</a> .
<b>Rule Bundle</b>	Enables you to select the rule group with which the Impact Analysis rule works.
<b>Severity</b>	Sets the severity level that we want to simulate for the triggered CIs.
<b>Triggered CIs</b>	Select the CIs that represent the changes you want to make to the system. Opens the CI Selector.

### Affected Application Tab

This tab displays all the CIs that belong to a specific business application, which were affected by the triggered CI severity change.

User interface elements are described below:

UI Element (A-Z)	Description
<b>Display Label</b>	The name of the CI or relationship as it appears in the topology map.
<b>Trigger Severity</b>	The severity selected in the <b>Severity</b> box.

### Grouping by CIT Tab

This tab displays all the CIs related to the triggered CIs that are impacted in the system as a result of the simulated changes, sorted by CI type.

User interface elements are described below:



UI Element (A-Z)	Description
<b>Display Label</b>	The name of the CI or relationship as it appears in the topology map.
<b>Trigger Severity</b>	The severity selected in the <b>Severity</b> box.

### Triggered CIs Tab

This tab displays all the CIs that represent the changes you want to make to the system. The CIs in this tab are the CIs selected in the **Triggered CIs** box.

User interface elements are described below:

UI Element (A-Z)	Description
<b>Display Label</b>	The name of the CI or relationship as it appears in the topology map.

### Job List Dialog Box



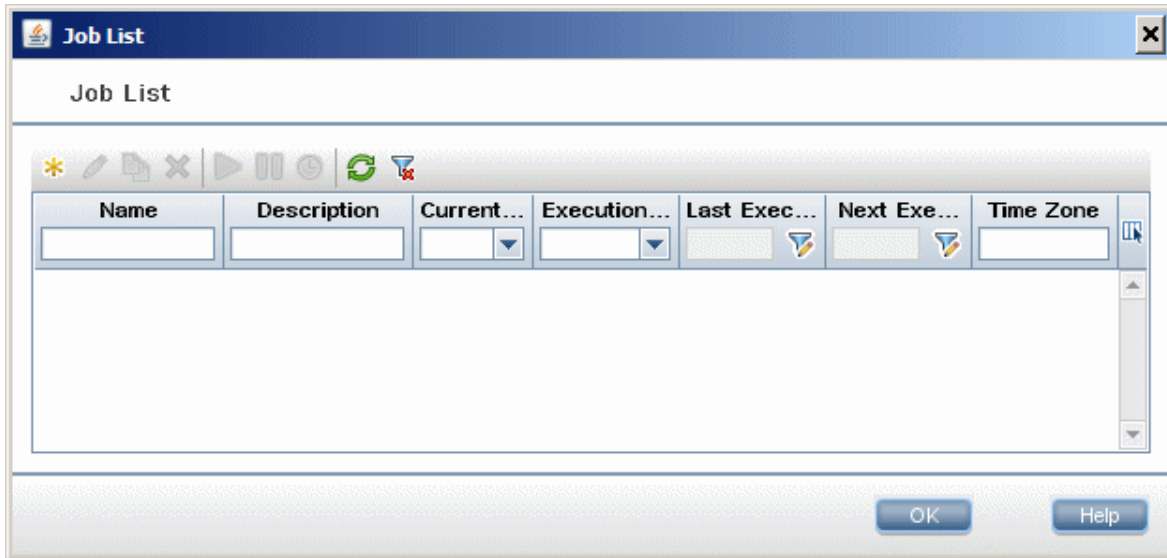







This dialog box displays a list of the reports/snapshots that were scheduled to run in the "[Schedule Report/Snapshot Dialog Box](#)" on page 444.





<b>To access</b>	<ul style="list-style-type: none"> <li>To display a list of reports scheduled to run, select <b>Managers &gt; Modeling &gt; Reports</b>. On the Reports page, click the <b>Show Scheduled Report Jobs</b>  button.</li> <li>To define a schedule for taking snapshots, select <b>Managers &gt; Modeling &gt; Reports</b>. In the Topology Reports pane, select the required view, click the <b>Snapshots</b>  button,</li> </ul>
------------------	--

	and then select <b>Show Scheduled Snapshot Jobs</b> .
<b>Relevant tasks</b>	<ul style="list-style-type: none"> <li>• <a href="#">"How to View a Topology Report" on page 357</a></li> <li>• <a href="#">"How to Generate a Custom Report" on page 358</a></li> </ul>

User interface elements are described below:

<b>UI Element (A-Z)</b>	<b>Description</b>
	<b>Insert New Scheduled Report.</b> Enables you to define a new job using the Schedule Report dialog box.
	<b>Edit Job.</b> Enables you to edit the selected job using the Schedule Report dialog box.
	<b>Create Copy.</b> Enables you to create a copy of the selected job. Opens a new job in the Schedule Report dialog box that uses the details of the selected job.
	<b>Remove Job.</b> Deletes the selected job from the list of scheduled jobs.
	<b>Run Job Immediate.</b> Runs the selected job.
	<b>Pause Job.</b> Pauses the selected job. Enabled only if the job has a <b>Pending</b> status.
	<p><b>Resume Job.</b> Resumes the selected job.</p> <p><b>Note:</b> The <b>Resume</b> button is enabled only for jobs that have a <b>Paused</b> status.</p>
	<b>Refresh.</b> Refreshes the list of scheduled jobs.
	<b>Clear filter.</b> Clears the current filter.
	<b>Change visible columns.</b> Enables you to select the columns to be displayed.
<b>Current Status</b>	<p>The current status of each scheduled job:</p> <ul style="list-style-type: none"> <li>• <b>Running.</b> The job is currently executing.</li> <li>• <b>Pending.</b> The job is waiting for the scheduling requirements to be fulfilled.</li> <li>• <b>Completed.</b> The job has finished executing.</li> <li>• <b>Paused.</b> The job has been paused.</li> </ul>

UI Element (A-Z)	Description
	<p><b>Note:</b> If a job has a <b>Completed</b> status, and you want to resume running the job, you can either click Run Job Immediate or change the <b>Next Execution Time</b> to the current time. If you change it to a future time, the status changes to <b>Pending</b>.</p>
<b>Description</b>	A description of the scheduled job as defined in the Schedule Report dialog box.
<b>Execution Status</b>	<p>The job's current execution status:</p> <ul style="list-style-type: none"> <li>• <b>Success.</b> The job completed successfully (denoted by the  icon).</li> <li>• <b>Failure.</b> The job failed to execute (denoted by the  icon). Hold the pointer over the  icon to display:                         <ul style="list-style-type: none"> <li>◦ A description of the error</li> <li>◦ The related HP Universal CMDB internal exception</li> </ul> </li> <li>• <b>None.</b> The job has not yet been executed.</li> </ul>
<b>Last Execution Time</b>	The last time the report ran.
<b>Name</b>	The name of the scheduled job as defined in the Schedule Report dialog box.
<b>Next Execution Time</b>	The next time the report is scheduled to run.
<b>Time Zone</b>	The time zone in which the job is scheduled to run.

## Licensed OSIs Report

This report shows all the licensed OSIs (UDi and Full) and all third-party licenses that are counted.

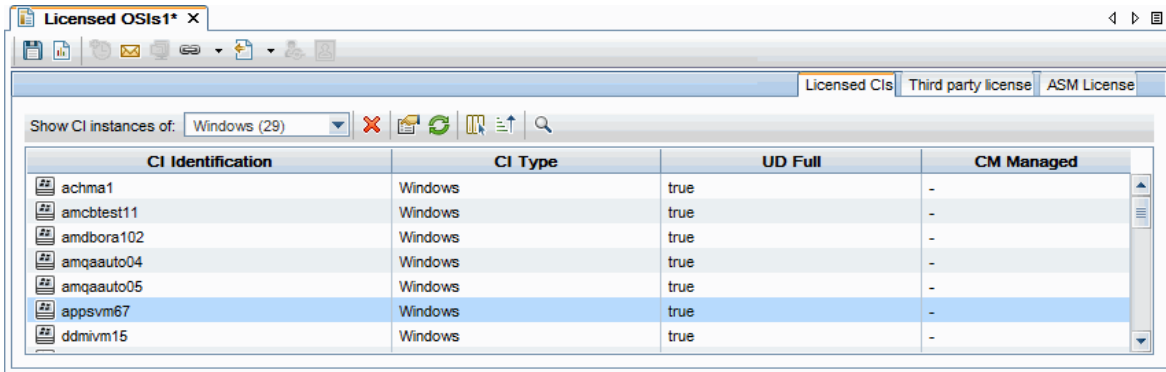

<p><b>To access</b></p>	<p>Select <b>Modeling &gt; Reports</b>. In the <b>Custom Reports</b> pane, do one of the following:</p> <ul style="list-style-type: none"> <li>• Click the <b>Create New Report</b>  button and select <b>Licensed OSIs Report</b>.</li> <li>• Click <b>Administration</b> and do one of the following:                     <ul style="list-style-type: none"> <li>◦ Right-click <b>Licensed OSIs Report</b> and select <b>Create New Report</b>.</li> <li>◦ Double-click <b>Licensed OSIs Report</b>.</li> <li>◦ Select <b>Licensed OSIs Report</b> and drag it onto the right pane.</li> </ul> </li> </ul>
<p><b>Relevant tasks</b></p>	<p>"Generate a Custom Report" in the <i>HP Universal CMDB Modeling Guide</i></p>

User interface elements are described below (unlabeled elements are shown in angle brackets>):

<p><b>UI Element (A-Z)</b></p>	<p><b>Description</b></p>
<p>&lt;Shortcut Menu&gt;</p>	<p>Right-click a CI in the report to access the IT Universe Manager shortcut menu. For details, see <a href="#">"IT Universe Manager Shortcut Menu" on page 235</a>.</p>
<p>&lt;Toolbar&gt;</p>	<p>For details, see <a href="#">"Report Toolbar Options" on page 460</a>.</p>

### Licensed CIs Tab

<p><b>Important Information</b></p>	<p>To view the change history of a CI, right-click anywhere in the row of the required CI and select <b>CI History</b>.</p>
-------------------------------------	---

User interface elements are described below (unlabeled elements are shown in angle brackets):

UI Element (A-Z)	Description
<Toolbar>	For details, see <a href="#">"Report Toolbar Options" on page 460.</a>
<Shortcut menu>	For details, see <a href="#">"IT Universe Manager Shortcut Menu" on page 235.</a>
CI Identification	The name and icon of the CI.
CI Type	The type of the CI.
CM Managed	Indicates whether a CM license is available or not.
UD Full/UD SAW	The UI element displayed for this column depends on the type of the existing license and whether the license is available or not.
UD Inventory	Indicates whether a UD Inventory license is available or not.

**Note:** The **CM Managed**, **UD Full/UD SAW**, and **UD Inventory** columns are visible in the user interface if a relevant license of that sort is applied.

Values for these three columns include:

- **"true"** if the CI instance is counted in the relevant context of the similar license
- **"false"** if the CI instance is counted in the relevant context of the similar license, but exceeds capacity limit.
- **"-"** if the CI instance is not applicable within the license type mentioned above.

### Third party licenses Tab

User interface elements are described below (unlabeled elements are shown in angle brackets):

UI Element (A-Z)	Description
<Toolbar>	For details, see <a href="#">"Report Toolbar Options" on page 460.</a>
Adapter Name	The name of the adapter.
Integration Name	The name of the integration that is taken into consideration for a Managed Data Repository (MDR) license.

## ASM License Tab

User interface elements are described below (unlabeled elements are shown in angle brackets):

UI Element (A-Z)	Description
<Toolbar>	For details, see <a href="#">"Report Toolbar Options" on page 460.</a>
Display Label	Name for a Discovery Service Activity.
ASM License	Indicates status of ASM license: <ul style="list-style-type: none"> <li>• <b>True</b> - A valid ASM license is available.</li> <li>• <b>False</b> - ASM license is not available.</li> </ul>

## Migration Progress Report

This report displays information about nodes and agents that may be useful after a DDMI to Universal Discovery migration.

<b>To access</b>	Select <b>Modeling &gt; Reports</b> . In the <b>Custom Reports</b> pane, click <b>Administration</b> , then select <b>Migration Progress Report</b> . Click <b>Generate</b> to create a report.
------------------	---

User interface elements are described below:

UI Element (A-Z)	Description
<Toolbar>	For details, see <a href="#">"Report Toolbar Options" on page 460.</a>
Group by	Select the grouping you want. For example, to see the nodes that have agents installed, select <b>Nodes with agents</b> . Moreover, to see an overview of all parameters with count information, select <b>Overview</b> .

## Network Device Breakdown Report

This report displays a breakdown of network devices. Only the network devices that meet the following conditions appear in the report:

- The CIT of the network device has been assigned the qualifier **NETWORK\_DEVICES**. For details, see ["Qualifier Tab" on page 85.](#)

Include All Integration Points

Country or Province:

State:

City:

## Network Devices Breakdown

Break down by CI Instances Count

[Click on the chart sections to drill down](#)

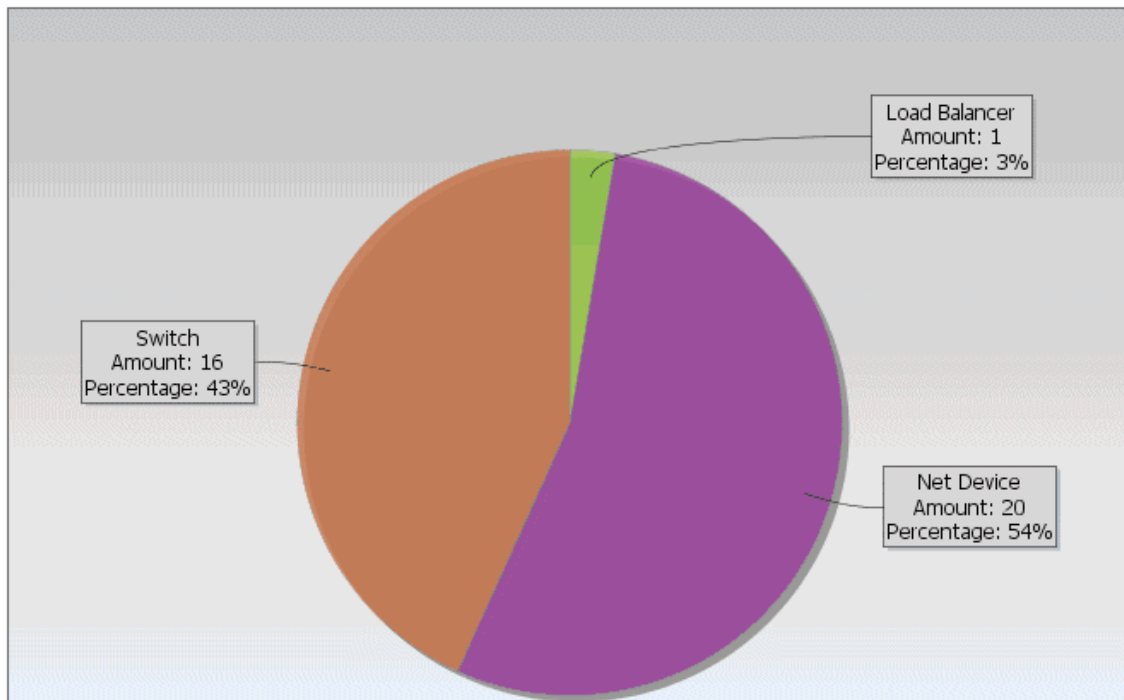

<p><b>To access</b></p>	<p>Select <b>Managers &gt; Modeling &gt; Reports</b>. In the <b>Custom Reports</b> pane, do one of the following:</p> <ul style="list-style-type: none"><li>• Click the <b>Create New Report</b>  button and select <b>Network Device Breakdown Report</b>.</li><li>• Under <b>Breakdown</b>:<ul style="list-style-type: none"><li>◦ Double-click <b>Network Device Breakdown Report</b>.</li><li>◦ Right-click <b>Network Device Breakdown Report</b> and select <b>Create New Report</b>.</li><li>◦ Select <b>Network Device Breakdown Report</b>, and drag it onto the right pane.</li></ul></li></ul>
-------------------------	--

<b>Relevant tasks</b>	<a href="#">"How to Generate a Custom Report" on page 358</a>
-----------------------	---

User interface elements are described below (unlabeled elements are shown in angle brackets):

<b>UI Element (A-Z)</b>	<b>Description</b>
<b>&lt;Bar graph/Pie chart&gt;</b>	<p>Each segment of the pie chart/column in a bar graph represents a different network device.</p> <p>Click a slice/bar to drill down to see the number of CI instances per network device.</p> <p>When you hold the mouse over each segment/bar, a tooltip indicates the name of the network device, the number of CI instances found for each network device, the percentage of the pie it represents (when viewing the information in pie chart format), and the CI type the slice/bar represents.</p> <p>Click a segment/bar to view a specific network device sorted by manufacturer. Click a segment/bar again to view the details of the CI instances found for that network device for that manufacturer in table format.</p> <p>Each color in the legend represents a different network device.</p>
<b>&lt;Breadcrumbs&gt;</b>	<p>Displays the levels through which you have navigated to get to the current level. Appears horizontally across the top of the chart.</p> <p><b>Note:</b> Each level in the list of breadcrumbs is a clickable link.</p>
<b>&lt;Toolbar&gt;</b>	For details, see <a href="#">"Report Toolbar Options" on page 460</a> .
<b>City</b>	<p>Select the city for which you want to view operating system breakdown data, or select <b>All</b> to show the breakdown for all cities.</p> <p><b>Note:</b> This is only relevant for CITs that contain data in the <b>City</b> attribute.</p>
<b>Country or Province</b>	<p>Select the country or province for which you want to view operating system breakdown data, or select <b>All</b> to show the breakdown for all countries or provinces.</p> <p><b>Note:</b> This is only relevant for CITs that contain data in the <b>Country or Province</b> attribute.</p>
<b>Include All Integration Points</b>	Select the check box to include federated CIs in the report. When the check box is cleared, only local CIs are included in the report.



UI Element (A-Z)	Description
<b>State</b>	Select the state for which you want to view operating system breakdown data, or select <b>All</b> to show the breakdown for all states.  <div style="background-color: #f0f0f0; padding: 5px;"><b>Note:</b> This is only relevant for CITs that contain data in the <b>State</b> attribute.</div>

## Node OS Breakdown Report

This report displays a breakdown of operating systems. You can view all deployed operating systems or you can view data for operating systems at a certain location or running on a certain subnet.

Include All Integration Points  
 Filter:  By Location  By Subnet  
 Country or Province:   
 State:   
 City:

### Nodes Breakdown

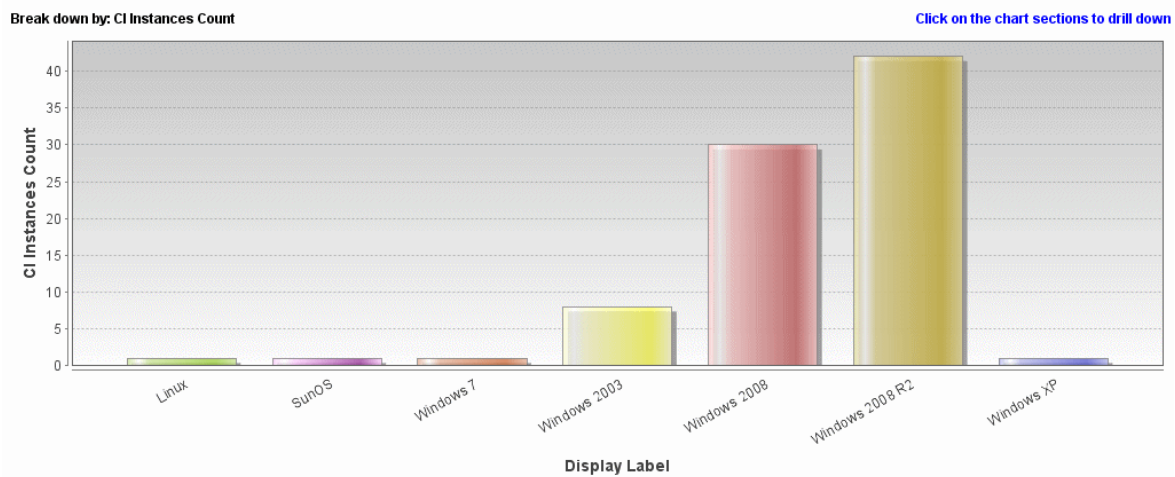

<b>To access</b>	<p>Select <b>Managers &gt; Modeling &gt; Reports</b>. In the <b>Custom Reports</b> pane, do one of the following:</p> <ul style="list-style-type: none"> <li>• Click the <b>Create New Report</b>  button and select <b>Node OS Breakdown Report</b>.</li> <li>• Under <b>Breakdown</b>:                             <ul style="list-style-type: none"> <li>◦ Double-click <b>Node OS Breakdown Report</b>.</li> </ul> </li> </ul>
------------------	---

	<ul style="list-style-type: none"> <li>Right-click <b>Node OS Breakdown Report</b> and select <b>Create New Report</b>.</li> <li>Select <b>Node OS Breakdown Report</b>, and drag it onto the right pane.</li> </ul>
<b>Relevant tasks</b>	<a href="#">"How to Generate a Custom Report" on page 358</a>

User interface elements are described below (unlabeled elements are shown in angle brackets):

<b>UI Element (A-Z)</b>	<b>Description</b>
<b>&lt;Bar graph/Pie chart&gt;</b>	<p>Each segment of the pie chart/column in a bar graph represents a different operating system.</p> <p>Click a slice/bar to drill down to see the number of CI instances per operating system in table format.</p> <p>When you hold the mouse over each segment/bar, a tooltip indicates the name of the operating system, the number of CI instances found for each operating system, the percentage of the pie it represents (when viewing the information in pie chart format), and the CI type the slice/bar represents.</p>
<b>&lt;Breadcrumbs&gt;</b>	<p>Displays the levels through which you have navigated to get to the current level. Appears horizontally across the top of the chart.</p> <p><b>Note:</b> Each level in the list of breadcrumbs is a clickable link.</p>
<b>&lt;Shortcut Menu&gt;</b>	<p>Drill down to the level of individual CIs and right-click a CI in the report to access the IT Universe Manager shortcut menu. For details, see <a href="#">"IT Universe Manager Shortcut Menu" on page 235</a>.</p>
<b>&lt;Toolbar&gt;</b>	<p>For details, see <a href="#">"Report Toolbar Options" on page 460</a>.</p>
<b>City</b>	<p>Select the city for which you want to view operating system breakdown data, or select <b>All</b> to show the breakdown for all cities.</p> <p><b>Note:</b> This is only relevant for CITs that contain data in the <b>City</b> attribute.</p>
<b>Country or Province</b>	<p>Select the country or province for which you want to view operating system breakdown data, or select <b>All</b> to show the breakdown for all countries or provinces.</p> <p><b>Note:</b> This is only relevant for CITs that contain data in the <b>Country or Province</b> attribute.</p>

UI Element (A-Z)	Description
<b>Filter</b>	Select one of the following: <ul style="list-style-type: none"> <li>• <b>By Location.</b> Select the required location.</li> <li>• <b>By Subnet.</b> Enter the required subnet. You can use the wildcard character asterisk (*) to include several subnets. For example, 1 1 *.</li> </ul>
<b>Include All Integration Points</b>	Select the check box to include federated CIs in the report. When the check box is cleared, only local CIs are included in the report.
<b>State</b>	Select the state for which you want to view operating system breakdown data, or select <b>All</b> to show the breakdown for all states. <div style="background-color: #f0f0f0; padding: 5px; margin-top: 10px;"> <p><b>Note:</b> This is only relevant for CITs that contain data in the <b>State</b> attribute.</p> </div>

## Node Summary Report

This report displays all the nodes detected in the system and the hardware installed on them.

Group By: None ▼

✔ Generate

Display Label	Memory Units	Create Time	CI Type
LABM3UCMDB08.devlab.ad	0	Mon Apr 16 2012 04:28 AM IDT	nt
MTtest	0	Mon Apr 16 2012 08:58 AM IDT	node
newNode	0	Tue Apr 17 2012 09:55 AM IDT	node
node1	0	Mon Apr 16 2012 08:08 AM IDT	node

<b>To access</b>	<p>Select <b>Managers &gt; Modeling &gt; Reports</b>. In the <b>Custom Reports</b> pane, do one of the following:</p> <ul style="list-style-type: none"> <li>• Click the <b>Create New Report</b>  button and select <b>Node Summary Report</b>.</li> <li>• Under <b>Inventory</b>: <ul style="list-style-type: none"> <li>◦ Double-click <b>Node Summary Report</b>.</li> <li>◦ Right-click <b>Node Summary Report</b> and select <b>Create New Report</b>.</li> </ul> </li> </ul>
------------------	---

	<ul style="list-style-type: none"> <li>◦ Select <b>Node Summary Report</b>, and drag it onto the right pane.</li> </ul>
<b>Important information</b>	<p>If you select one of the grouping options, the top level of the report displays the number of nodes for each group. Click on the number of nodes to drill down to the next layer and view data for those nodes. If you selected <b>None</b> as the grouping option, all the nodes appear in the top layer.</p> <p>The second layer also contains some summary columns with numbers that are clickable links (for example, <b>Disk Devices</b> displays the number of disk devices for each node). Click the number to drill down to the next layer and view detailed data.</p> <p>In any layer, you can use the <b>Select Columns</b>  button to select the attributes to display in the report.</p>
<b>Relevant tasks</b>	<p><a href="#">"How to Generate a Custom Report" on page 358</a></p>



User interface elements are described below (unlabeled elements are shown in angle brackets):

<b>UI Element (A-Z)</b>	<b>Description</b>
<b>&lt;Breadcrumbs&gt;</b>	<p>Displays the levels through which you have navigated to get to the current level. Appears horizontally across the top of the chart.</p> <p><b>Note:</b> Each level in the list of breadcrumbs is a clickable link.</p>
<b>&lt;Shortcut Menu&gt;</b>	<p>Right-click a CI in the report to access the IT Universe Manager shortcut menu. For details, see <a href="#">"IT Universe Manager Shortcut Menu" on page 235</a>.</p>
<b>&lt;Toolbar&gt;</b>	<p>For details, see <a href="#">"Report Toolbar Options" on page 460</a>.</p>
<b>Group By</b>	<p>Select the method for displaying the data. The available options are:</p> <ul style="list-style-type: none"> <li>• None</li> <li>• Location</li> <li>• OS Family</li> </ul>

## Node Summary by VLAN Report

This report displays all the nodes detected in the system grouped by VLAN.

VLAN	Device Count
trnet-default	1
fdclinet-default	1
VLAN0176	1
VLAN0177	1
default	1
fdcli-default	1
token-ring-default	1
VLAN0178	1

<p><b>To access</b></p>	<p>Select <b>Managers &gt; Modeling &gt; Reports</b>. In the <b>Custom Reports</b> pane, do one of the following:</p> <ul style="list-style-type: none"> <li>• Click the <b>Create New Report</b>  button and select <b>Node Summary by VLAN Report</b>.</li> <li>• Under <b>Inventory</b>:                     <ul style="list-style-type: none"> <li>◦ Double-click <b>Node Summary by VLAN Report</b>.</li> <li>◦ Right-click <b>Node Summary by VLAN Report</b> and select <b>Create New Report</b>.</li> <li>◦ Select <b>Node Summary by VLAN Report</b>, and drag it onto the right pane.</li> </ul> </li> </ul>
<p><b>Important information</b></p>	<p>The top level of the report displays the number of devices for each VLAN. You can click the number to drill down to view detailed data on each VLAN. Use the <b>Select Columns</b>  button to select the attributes to display in the report.</p> <p><b>Note:</b> Nodes not connected to a VLAN are not displayed in the report.</p>
<p><b>Relevant tasks</b></p>	<p><a href="#">"How to Generate a Custom Report" on page 358</a></p>

User interface elements are described below (unlabeled elements are shown in angle brackets>):

UI Element (A-Z)	Description
<p>&lt;Breadcrumbs&gt;</p>	<p>Displays the levels through which you have navigated to get to the current level. Appears horizontally across the top of the chart.</p>

UI Element (A-Z)	Description
	<b>Note:</b> Each level in the list of breadcrumbs is a clickable link.
<Shortcut Menu>	Right-click a CI in the report to access the IT Universe Manager shortcut menu. For details, see <a href="#">"IT Universe Manager Shortcut Menu" on page 235</a> .
<Toolbar>	For details, see <a href="#">"Report Toolbar Options" on page 460</a> .

## Number of Changes Report

This report displays the number of detected changes in a CIT (additions, deletions, or updates) within a defined time period.

Time range: Last day Date from: Mon Mar 1 2010 03:19 PM IST Date until: Tue Mar 2 2010 03:19 PM IST

### Number of Changes Grouped by CI Type

Break down by Number of Changes

[Click on the chart sections to drill down](#)

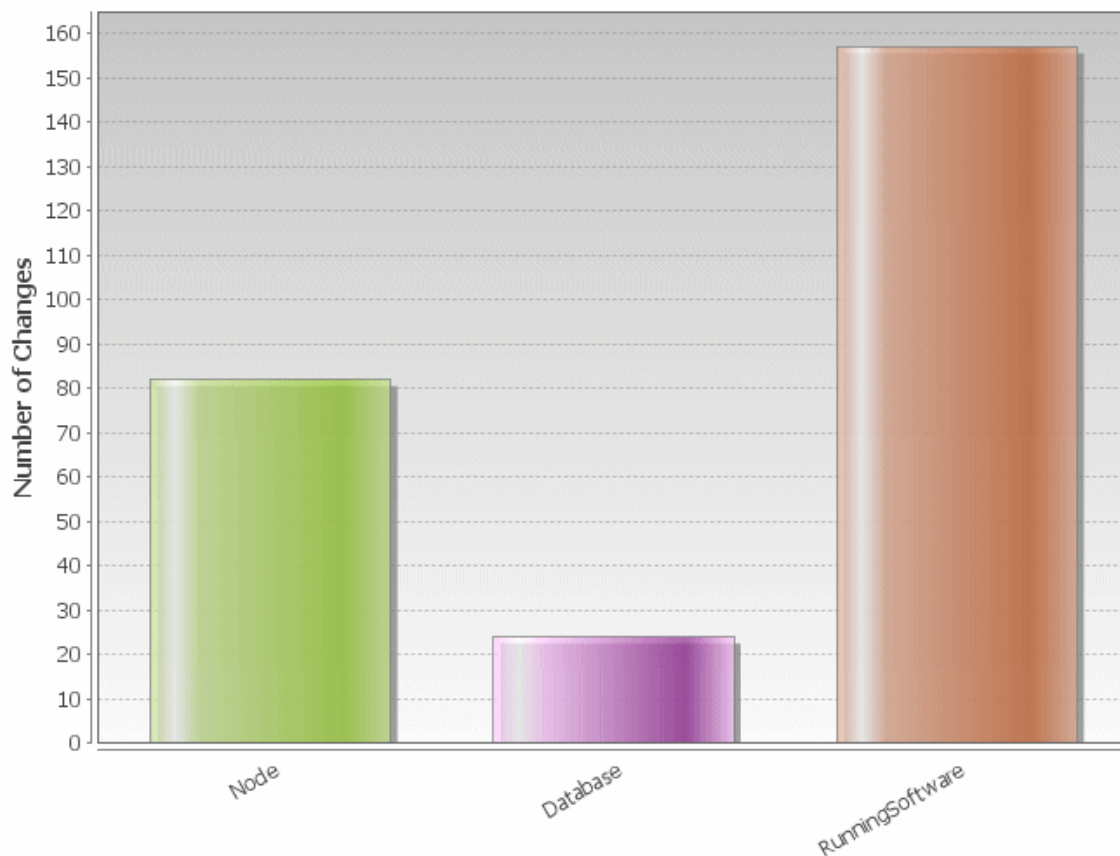

**To access**

Select **Managers > Modeling > Reports**. In the **Custom Reports** pane, do one of the following:

- Click the **Create New Report**  button and select **Number of Changes Report**.
- Under **Change**:
  - Double-click **Number of Changes Report**.

	<ul style="list-style-type: none"> <li>Right-click <b>Number of Changes Report</b> and select <b>Create New Report</b>.</li> <li>Select <b>Number of Changes Report</b>, and drag it onto the right pane.</li> </ul>
<b>Important information</b>	<p><b>Note:</b> In a multi-tenancy environment, the Number of Changes report only displays changes that are relevant to the tenants associated with your <b>View CIs</b> permission. However, <b>Remove CI/relationship</b> events that occurred before an upgrade to UCMDB version 10.01 are displayed independent of the tenants associated with the <b>View CIs</b> permission.</p>
<b>Relevant tasks</b>	<p><a href="#">"How to Generate a Custom Report" on page 358</a></p>

User interface elements are described below (unlabeled elements are shown in angle brackets):

<b>UI Element (A-Z)</b>	<b>Description</b>
<b>&lt;Bar graph/Pie chart&gt;</b>	<p>On the first level, each segment of the pie chart/column in a bar graph represents a CIT of a CI or a relationship in which there was a detected change. The legend displays the colors that represent each CIT.</p> <p>When you hold the mouse over the relevant color of each segment/bar, a tooltip indicates the number of changes that occurred for that CIT the percentage of the pie it represents (when viewing the information in pie chart format), and the CI type the slice/bar represents</p> <p>Click a slice/bar to drill down to the second level. to view the types of changes that occurred for each CIT and the CIT's children. The colors in each segment/bar represent the different types of changes that occurred in the application. See the legend to verify the change type each color represents.</p> <p>Click the required color to drill down to see the number of CIs or relationships for that type of change in table format. Once you do the second drill down, you get the instances that represent the changes described.</p> <p>Changes of type <b>added</b> or <b>updated</b> are taken from the CMDB. Changes of type <b>deleted</b> are taken from the CI or relationship history.</p>
<b>&lt;Shortcut Menu&gt;</b>	<p>Drill down to the level of individual CIs and right-click a CI in the report to access the IT Universe Manager shortcut menu. For details, see <a href="#">"IT Universe Manager Shortcut Menu" on page 235</a>.</p>
<b>&lt;Toolbar&gt;</b>	<p>For details, see <a href="#">"Report Toolbar Options" on page 460</a>.</p>
<b>Date</b>	<p>Configure a start date and time for the report.</p>



UI Element (A-Z)	Description
<b>from</b>	
<b>Date until</b>	Configure an end date and time for the report.
<b>Time range</b>	Select a time frame over which to display the detected changes. The system automatically provides the starting and ending dates in the <b>Date from</b> and <b>Date until</b> boxes.  <div style="background-color: #f0f0f0; padding: 5px; border: 1px solid #ccc;"> <p><b>Note:</b> If you select <b>Custom</b>, you can manually configure a starting and ending date in the <b>Date from</b> and <b>Date until</b> boxes.</p> </div>

## Recognized Applications Report

This report displays all the installed applications on the node where you are running the discovery probe.

Group By: Related Node

Generate

[Recognized Applications Report](#) → Installed Softwares On amdev02

Display Label	Discovered/Vendor	Version
7Zip	Igor Pavlov	4.42
Adobe Reader	Adobe	7.0.8
AssetCenter	Hewlett-Packard (Peregrine Systems)	4.00
BusinessObjects Enterprise Client Tools	SAP (Business Objects)	XI 3.1
CollabNet Subversion Command-Line Client	CollabNet	1.6.12
Crystal Report Runtime	SAP (Business Objects)	2008 sp3
DB2 Data Server Client	IBM	9.7.300.291
Firefox	Mozilla	3.6.17
HP Asset Manager	Hewlett-Packard	5.12
HP Asset Manager API	Hewlett-Packard	9.30
HP Asset Manager Import Tool	Hewlett-Packard	5.11
HP Performance Manager	Hewlett-Packard	9.00

<b>To access</b>	<p>Select <b>Managers &gt; Modeling &gt; Reports</b>. In the <b>Custom Reports</b> pane, do one of the following:</p> <ul style="list-style-type: none"> <li>• Click the <b>Create New Report</b>  button and select <b>Recognized Applications Report</b>.</li> <li>• Under <b>Inventory</b>:             <ul style="list-style-type: none"> <li>◦ Double-click <b>Recognized Applications Report</b>.</li> </ul> </li> </ul>
------------------	--

	<ul style="list-style-type: none"> <li>Right-click <b>Recognized Applications Report</b> and select <b>Create New Report</b>.</li> <li>Select <b>Recognized Applications Report</b>, and drag it onto the right pane.</li> </ul>
<b>Important information</b>	<p>The top level of the report displays the number of installed applications for each application. You can drill down to view detailed data on specific installed applications.</p> <p>Use the <b>Select Columns</b>  button to select the attributes to display in the report. When the report is grouped by Application Name or Vendor Name, a column called <b>Installed On</b> is available at the level of installed applications (after drilling down). The column displays the location where the application is installed and provides a clickable link to the node.</p> <p>When the report is grouped by Related Node, a column called <b>Installed Software</b> is available, which displays the number of installed applications on that node. It also provides a clickable link to drill down and display the applications' details.</p>
<b>Relevant tasks</b>	<a href="#">"How to Generate a Custom Report" on page 358</a>

User interface elements are described below (unlabeled elements are shown in angle brackets):

<b>UI Element (A-Z)</b>	<b>Description</b>
<b>&lt;Breadcrumbs&gt;</b>	<p>Displays the levels through which you have navigated to get to the current level. Appears horizontally across the top of the chart.</p> <p><b>Note:</b> Each level in the list of breadcrumbs is a clickable link.</p>
<b>&lt;Shortcut Menu&gt;</b>	Right-click a CI in the report to access the IT Universe Manager shortcut menu. For details, see <a href="#">"IT Universe Manager Shortcut Menu" on page 235</a> .
<b>&lt;Toolbar&gt;</b>	For details, see <a href="#">"Report Toolbar Options" on page 460</a> .
<b>Group By</b>	<p>Select the method for displaying the data. The available options are:</p> <ul style="list-style-type: none"> <li>Application Name</li> <li>Vendor Name</li> <li>Related Node</li> </ul>

## Report Properties Dialog Box

This dialog box enables you to set the report title and subtitle.

<b>To access</b>	Click the <b>Report Properties</b>  button on the report toolbar in the Reports module or on the TQL Query Editor toolbar in Modeling Studio.
<b>See also</b>	<a href="#">"Topology Reports Overview" on page 356</a>

User interface elements are described below (unlabeled elements are shown in angle brackets>):

<b>UI Element (A-Z)</b>	<b>Description</b>
<b>Format</b>	Select the report format. The following options are available: <ul style="list-style-type: none"> <li>• <b>Flat.</b> The CIs in the top layer are displayed as links. You can click a CI to drill down to display its children.</li> <li>• <b>Hierarchical.</b> All CIs of the report are displayed in one table in tree format.</li> </ul>
<b>Sub Report Perspective</b>	Select the <b>Sub Report Perspective</b> check box to make this perspective available for building a Sub Report in the Generate Sub Report dialog box. <div style="background-color: #f0f0f0; padding: 5px; margin-top: 10px;"> <p><b>Note:</b> This check box is only available in the Report Properties dialog box for perspectives.</p> </div>
<b>Subtitle</b>	Enter the report subtitle.
<b>Title</b>	Enter the report title.

## Reports Page

This page enables you to create Topology reports based on the data in views, as well as a number of predefined Custom report types.

<b>To access</b>	<b>Managers &gt; Modeling &gt; Reports</b>
<b>Relevant tasks</b>	<ul style="list-style-type: none"> <li>• <a href="#">"How to View a Topology Report" on page 357</a></li> <li>• <a href="#">"How to Generate a Custom Report" on page 358</a></li> <li>• <a href="#">"How to Compare CIs" on page 359</a></li> <li>• <a href="#">"How to Compare Snapshots" on page 360</a></li> </ul>
<b>See also</b>	<ul style="list-style-type: none"> <li>• <a href="#">"Report Toolbar Options" on page 460</a></li> <li>• <a href="#">"Custom Reports Overview " on page 357</a></li> </ul>





	<ul style="list-style-type: none"> <li>• <a href="#">"Topology Reports Overview" on page 356</a></li> </ul>
--	---





User interface elements are described below (unlabeled elements are shown in angle brackets):



UI Element (A-Z)	Description
<b>&lt;Left pane&gt;</b>	The following panes are included: <ul style="list-style-type: none"> <li>• <b>Topology Reports.</b> Displays reports of the views and templates that were created using the Modeling Studio. For details, see <a href="#">"Topology Report" on page 453</a>.</li> <li>• <b>Custom Reports.</b> Displays various preset types of reports in chart or table format. For details, see <a href="#">"Reports User Interface" on page 363</a>.</li> </ul>
<b>&lt;Right pane&gt;</b>	Displays the selected report.





### Left Pane





User interface elements are described below:

UI Element (A-Z)	Description
	<p><b>Create New Report.</b> Enables you to select the type of report that you want to create.</p> <p>In the Topology Reports pane, select <b>Pattern View</b>, <b>Perspective</b>, or <b>Template</b>, and you go directly to the Modeling Studio to create the selected type of resource.</p> <p>In the Custom Reports pane, select a report from the list of Custom reports.</p>
	<p><b>Open Report.</b> Generates an existing report in the Report pane.</p>
	<p><b>Show View Definition.</b> Displays the selected view's definition in the Modeling Studio. For details, see <a href="#">"Modeling Studio" on page 254</a>.</p> <div style="background-color: #f0f0f0; padding: 5px; margin-top: 10px;"> <p><b>Note:</b> This option is available only for Topology Reports.</p> </div>
	<p><b>Delete Report.</b></p> <ul style="list-style-type: none"> <li>• In the Custom Reports pane, deletes the selected report.</li> </ul>

UI Element (A-Z)	Description
	<ul style="list-style-type: none"> <li>In the Topology Reports pane, deletes the archived report.</li> </ul>
	<p><b>Compare Report Archives.</b> Opens the Compare Archives report when two archives of the same report are selected.</p> <p><b>Note:</b> This option is available only for Topology Reports.</p>
	<p><b>Schedule Report.</b> Opens the Schedule Report dialog box, which enables you to define a job that:</p> <ul style="list-style-type: none"> <li>Schedules the generation of a report</li> <li>Specifies one or more formats in which to send the report, and the report's recipients</li> <li>Specifies the recurrence of the job</li> </ul> <p>For more information on the Schedule Report dialog box, see <a href="#">"Schedule Report/Snapshot Dialog Box" on page 444.</a></p> <p><b>Note:</b> This option is available only before you generate a report or when you open a saved report.</p>
	<p><b>Show Scheduled Reports Jobs.</b> Opens the Job List dialog box, which displays the reports that have been scheduled to run. For details, see <a href="#">"Job List Dialog Box" on page 417.</a></p>
	<p><b>Snapshots.</b> Enables you to do the following:</p> <ul style="list-style-type: none"> <li>Save a snapshot of the active report. For details, see <a href="#">"Save Snapshot Dialog Box" on page 249.</a></li> <li>Compare a previously saved snapshot to the active report or to another snapshot. For details, see <a href="#">"Compare Snapshots Report" on page 395.</a></li> <li>Schedule snapshots to be saved. For details, see <a href="#">"Schedule Report/Snapshot Dialog Box" on page 444.</a></li> <li>Display the currently scheduled snapshot jobs. or details, see <a href="#">"Job List Dialog Box" on page 417.</a></li> </ul>

UI Element (A-Z)	Description
	<p><b>Note:</b> This option is available only for Topology Reports.</p>
	<p><b>Send Mail.</b> Opens the Send Mail dialog box. You can send an email containing the generated report in various formats, or as a direct link. For details on the various formats, see <a href="#">"Report Toolbar Options" on page 460.</a></p> <p>Select one or more of the available formats for the generated report to be sent as attachments to an email recipient.</p> <p><b>Note:</b></p> <ul style="list-style-type: none"> <li>• Required fields are marked with an asterisk.</li> <li>• When entering an email address, ensure that the email's domain is a valid one.</li> <li>• In the Send Mail dialog box, the <b>From</b> field is populated with the email address defined in the user details for the current user. If no email is defined for the current user, the default email address of the customer is used.</li> </ul>
	<p><b>Generate Direct Link.</b> Creates a direct link to the specific location on the server of the selected report, or to the data that you have exported as a specific format.</p>
	<p><b>Export Report.</b> Enables you to select the format for previewing and exporting the report. The available options are:</p> <ul style="list-style-type: none"> <li>• <b>CSV.</b> The report data is formatted as a comma-separated values (CSV) text file that can be displayed in a spreadsheet.</li> </ul> <p><b>Note:</b> For the CSV formatted table data to display correctly, the comma (,) must be defined as the list separator. In Windows, to verify or modify the list separator value, open Regional Options from the Control Panel, and on the Numbers tab ensure that the comma is defined as the List Separator value. In Linux, you can specify the list separator in the application that opens the CSV file.</p> <ul style="list-style-type: none"> <li>• <b>PDF.</b> The report data is exported in PDF format.</li> </ul>

UI Element (A-Z)	Description
	<p><b>Note:</b> When exporting to PDF, select a reasonable number of columns to display to ensure that the report is legible.</p> <ul style="list-style-type: none"> <li>• <b>XLS.</b> The report data is formatted as an .xls (Excel) file that can be displayed in a spreadsheet.</li> </ul> <p><b>Note:</b> For large reports, you can reduce the time required for exporting the report by setting a fixed column size using the <b>Column Size For XLS Export</b> setting in the Infrastructure Settings Manager.</p> <ul style="list-style-type: none"> <li>• <b>XML.</b> The report data is formatted as an XML file that can be opened in a text or XML editor.</li> </ul> <p><b>Tip:</b> To extract HTML code from the report:</p> <ul style="list-style-type: none"> <li>• Open the file in an HTML editor</li> <li>• Copy the relevant table into the target file</li> </ul> <p><b>Note:</b> When you export a generated report, a dialog box opens asking whether you want to open the exported file. You can define whether to hide or display this message using the "<a href="#">User Preferences Dialog Box</a>" on page 93.</p>
	<p><b>Refresh.</b> Refreshes the report tree.</p>
	<p><b>Expand All.</b> Expands the tree structure.</p>
	<p><b>Collapse All.</b> Collapses the tree structure.</p>
	<p><b>Assign Tenants.</b> Opens the Assign Tenants dialog box which enables you to assign tenants to the selected custom report.</p> <p><b>Note:</b></p> <ul style="list-style-type: none"> <li>• This option is only relevant when a saved Custom Report is selected.</li> <li>• This option is only available when multi-tenancy is enabled.</li> </ul>

UI Element (A-Z)	Description
	<p><b>Manage Security.</b> Enables you to assign permission for the selected custom report to specific roles or to add the report to selected resource groups.</p> <p><b>Note:</b> This option is only available for Custom Reports.</p>
	<p><b>Hide Empty Folders.</b> Toggles between displaying all folders and only folders that contain reports.</p>
	<p><b>Find the next occurrence of the phrase/Find the previous occurrence of the phrase.</b> Enables you to move to the next or previous result of the search for the string entered in the <b>Find</b> field.</p>
	<p><b>Highlights all occurrences of the phrase.</b> Highlights all occurrences in the CI tree of the string entered in the <b>Find</b> field.</p>
<b>Find</b>	<p>Enter a search name or a portion of a search name in the <b>Find</b> field to locate it in the list.</p>

## Rulebase Support Report

This report displays information about device nodes and their attributes. This report may be useful for troubleshooting issues with the rulebase.

**Note:** Export this report in .csv format when sending to HP Support.

<b>To access</b>	Select <b>Modeling &gt; Reports</b> . In the <b>Topology Reports</b> pane, click <b>Network</b> , then double click <b>Rulebase Support Report</b> .
------------------	--

User interface elements are described below:



UI Element (A-Z)	Description
<Toolbar>	For details, see " <a href="#">Report Toolbar Options</a> " on page 460.



## Scan File Status Report

This report displays the scan files generated by the **Inventory Discovery by Scanner** discovery job.

Host	Run Date	Scanner Configuration	Upgrade Date	Probe Name
tsamqavm02	Wed Apr 25 2012 12:12 PM CST	_default.cxz	Wed Apr 25 2012 11:38 AM CST	DataFlowProbe
PCOESHV22	Wed Apr 25 2012 11:53 AM CST	_default.cxz	Wed Apr 25 2012 11:26 AM CST	DataFlowProbe
BBFFSMM2	Wed Apr 25 2012 11:53 AM CST	_default.cxz	Wed Apr 25 2012 11:28 AM CST	DataFlowProbe
tsamqavm59	Wed Apr 25 2012 11:55 AM CST	_default.cxz	Wed Apr 25 2012 11:27 AM CST	DataFlowProbe
WIN-B2FVLLC2080	Wed Apr 25 2012 11:54 AM CST	_default.cxz	Wed Apr 25 2012 11:26 AM CST	DataFlowProbe
ddmvm23	Tue Apr 24 2012 08:39 PM CST	_default.cxz	Tue Apr 24 2012 08:04 PM CST	DataFlowProbe
BBFFSMM5	Wed Apr 25 2012 11:57 AM CST	_default.cxz	Wed Apr 25 2012 11:32 AM CST	DataFlowProbe
amdevjp	Wed Apr 25 2012 11:40 AM CST	_default.cxz	Wed Apr 25 2012 11:26 AM CST	DataFlowProbe
ucmdb0101	Wed Apr 25 2012 12:01 PM CST	_default.cxz	Wed Apr 25 2012 11:38 AM CST	DataFlowProbe
tsamqavm64	Wed Apr 25 2012 12:08 PM CST	_default.cxz	Wed Apr 25 2012 11:33 AM CST	DataFlowProbe
SAQAXS930/VMP12	Wed Apr 25 2012 12:03 PM CST	_default.cxz	Wed Apr 25 2012 11:39 AM CST	DataFlowProbe
QASERVER2	Wed Apr 25 2012 12:15 PM CST	_default.cxz	Wed Apr 25 2012 11:39 AM CST	DataFlowProbe
g11nvm145	Wed Apr 25 2012 11:56 AM CST	_default.cxz	Wed Apr 25 2012 11:26 AM CST	DataFlowProbe
tsamqavm145	Wed Apr 25 2012 11:51 AM CST	_default.cxz	Wed Apr 25 2012 11:26 AM CST	DataFlowProbe
SMCI031	Wed Apr 25 2012 11:54 AM CST	_default.cxz	Wed Apr 25 2012 11:27 AM CST	DataFlowProbe

<p><b>To access</b></p>	<p>Select <b>Managers &gt; Modeling &gt; Reports</b>. In the <b>Custom Reports</b> pane, do one of the following:</p> <ul style="list-style-type: none"> <li>• Click the <b>Create New Report</b>  button and select <b>Scan File Status Report</b>.</li> <li>• Under <b>Discovery Status</b>: <ul style="list-style-type: none"> <li>◦ Double-click <b>Scan File Status Report</b>.</li> <li>◦ Right-click <b>Scan File Status Report</b> and select <b>Create New Report</b>.</li> <li>◦ Select <b>Scan File Status Report</b>, and drag it onto the right pane.</li> </ul> </li> </ul>
<p><b>Important information</b></p>	<p>The <b>Host</b> column indicates the node on which the scan file is generated. The <b>Run Date</b> and <b>Upgrade Date</b> columns display the latest run and upgrade times for the scanner . The <b>Scanner Configuration</b> and <b>Probe Name</b> columns display the configuration file and data flow probe gateway last used by the scanner. There is a hidden column called <b>Scan File Path</b>, which displays the full path of the scan file stored on the Data Flow Probe. To display this column, add it to the visible columns manually using the <b>Select Columns</b>  button every time a new report is generated.</p> <p>You can download the selected scan file to the local machine by right-clicking a scan file and selecting <b>Download Scan File</b> from the context menu. If the Inventory Tools are installed on the computer, when you open the downloaded scan file, the Viewer application is launched to display the contents of the scan file. For more information, see Inventory Tools. in the <i>HP Universal CMDB Data Flow Management Guide</i>.</p> <p>Right-click a scan and select <b>View Communication Log</b> to display the scanner log for debug information. This option is only available when the scan did not finish successfully.</p>

<b>Relevant tasks</b>	<a href="#">"How to Generate a Custom Report" on page 358</a>
-----------------------	---

User interface elements are described below (unlabeled elements are shown in angle brackets>):

UI Element (A-Z)	Description
<Shortcut Menu>	Right-click a CI in the report to access the IT Universe Manager shortcut menu. For details, see <a href="#">"IT Universe Manager Shortcut Menu" on page 235</a> .
<Toolbar>	For details, see <a href="#">"Report Toolbar Options" on page 460</a> .
<b>Date from</b>	Configure a start date and time for the report.
<b>Date until</b>	Configure an end date and time for the report.
<b>Time range</b>	Select a time frame over which to display the scan files. The system automatically provides the starting and ending dates in the <b>Date from</b> and <b>Date until</b> boxes.  <b>Note:</b> If you select <b>Custom</b> , you can manually configure a starting and ending date in the <b>Date from</b> and <b>Date until</b> boxes.









## Scanner Execution Details Report



This report displays runtime data from all Inventory Discovery jobs.

Job Status:  ▼

Group By:  ▼

 Generate

Display Label	Scanner Version	Start Time	Duration
 ddmivm03	10.00.000 build 400	Wed Mar 21 2012 01:00 PM IST	10 minute(s) 58 second(s)
 autoserver1	10.00.000 build 400	Wed Mar 21 2012 01:00 PM IST	22 minute(s) 32 second(s)
 amdev2003	10.00.000 build 400	Wed Mar 21 2012 01:01 PM IST	32 minute(s) 51 second(s)
 appsvm74	10.00.000 build 400	Wed Mar 21 2012 01:01 PM IST	33 minute(s) 22 second(s)
 btoa2k8r2en20	10.00.000 build 400	Wed Mar 21 2012 01:01 PM IST	22 minute(s) 31 second(s)
 amdev02	10.00.000 build 400	Wed Mar 21 2012 01:01 PM IST	32 minute(s) 51 second(s)
 itsamqavm64	10.00.000 build 400	Wed Mar 21 2012 01:09 PM IST	33 minute(s) 12 second(s)
 xs930vmdev10	10.00.000 build 400	Wed Mar 21 2012 01:10 PM IST	33 minute(s) 54 second(s)

<b>To access</b>	<p>Select <b>Managers &gt; Modeling &gt; Reports</b>. In the <b>Custom Reports</b> pane, do one of the following:</p> <ul style="list-style-type: none"> <li>• Click the <b>Create New Report</b>  button and select <b>Scanner Execution Details Report</b>.</li> <li>• Under <b>Discovery Status</b>: <ul style="list-style-type: none"> <li>◦ Double-click <b>Scanner Execution Details Report</b>.</li> <li>◦ Right-click <b>Scanner Execution Details Report</b> and select <b>Create New Report</b>.</li> <li>◦ Select <b>Scanner Execution Details Report</b>, and drag it onto the right pane.</li> </ul> </li> </ul>
<b>Important information</b>	<p>The report displays the following data for each Inventory Discovery job: the display label of the host being scanned, the scanner version, the start time, duration, schedule and status of the job, the probe name, any error messages and the last successful execution time for the job.</p> <p>Use the <b>Select Columns</b>  button to select the attributes to display in the report.</p>
<b>Relevant tasks</b>	<p><a href="#">"How to Generate a Custom Report" on page 358</a></p>



User interface elements are described below (unlabeled elements are shown in angle brackets>):

<b>UI Element (A-Z)</b>	<b>Description</b>
<b>&lt;Shortcut Menu&gt;</b>	Right-click a CI in the report to access the IT Universe Manager shortcut menu. For details, see <a href="#">"IT Universe Manager Shortcut Menu" on page 235</a> .
<b>&lt;Toolbar&gt;</b>	For details, see <a href="#">"Report Toolbar Options" on page 460</a> .
<b>Group By</b>	Select a grouping option for the displayed data.
<b>Job Status</b>	Select an option from the drop-down list to filter the results by the job status of the discovery job.

## Schedule Report/Snapshot Dialog Box

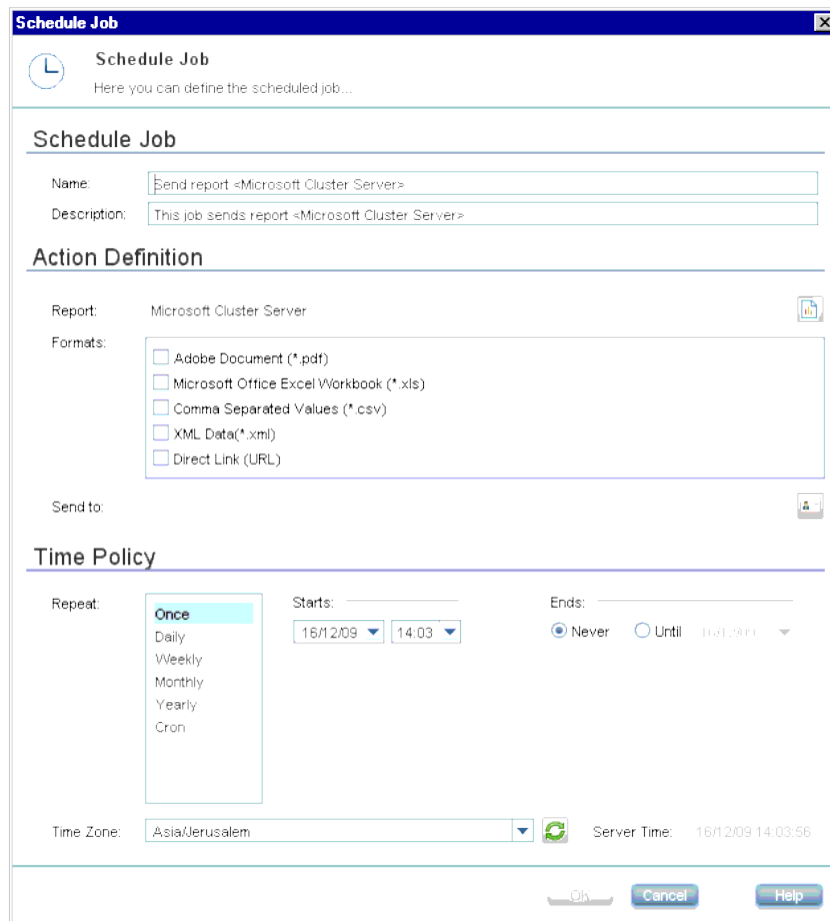

This dialog box enables you to define a schedule for running reports, and then send them by email to specified recipients. You can also define a schedule for taking snapshots of a specific view. You can see the list of reports/snapshots that have been scheduled to run in the ["Job List Dialog Box"](#) on page 417.



<p><b>To access</b></p>	<ul style="list-style-type: none"> <li>To schedule reports to run, select <b>Managers &gt; Modeling &gt; Reports</b>. In the Topology Reports or Custom Reports pane, select a report and click the <b>Schedule Report</b>  button.</li> <li>To define a schedule for taking snapshots, select <b>Managers &gt; Modeling &gt; Reports</b>. In the Topology Reports pane, select the required view, click the <b>Snapshots</b>  button, and then select <b>Schedule Snapshot</b>. Alternatively, in IT Universe Manager, click the <b>Snapshots</b> button in the CI Selector, and then select <b>Schedule Snapshot</b>.</li> </ul>
<p><b>Relevant</b></p>	<ul style="list-style-type: none"> <li><a href="#">"How to Compare CIs" on page 359</a></li> </ul>

<b>tasks</b>	<ul style="list-style-type: none"> <li>• <a href="#">"How to Compare Snapshots" on page 360</a></li> </ul>
--------------	--

The following elements are included:

UI Element (A-Z)	Description
	Click to validate the Cron expression you entered in the <b>Cron Expression</b> box.
	(Appears only when you select <b>Day of Month</b> .) Clears the selected dates in the calendar.
<b>Actions</b>	<p>The available options are:</p> <ul style="list-style-type: none"> <li>• <b>Mail.</b> Sends the report to the mail recipient in the <b>Send</b> box.</li> <li>• <b>Archive.</b> Archives the report result in the database.</li> <li>• <b>Save to File System.</b> Saves the report to the UCMDb Server file system (in the <b>UCMDbServer/Runtime</b> folder). This option is only available when the path is configured, using the <b>Report root folder</b> setting in Infrastructure Settings Manager.</li> </ul> <div style="background-color: #f0f0f0; padding: 10px; margin-top: 10px;"> <p><b>Note:</b></p> <ul style="list-style-type: none"> <li>• This feature is only available when defining a schedule for running reports.</li> <li>• You can select multiple options (for example, Mail and Save to File System).</li> </ul> </div>
<b>Cron Expression</b>	Enter a Cron expression to schedule a job. For a description of the fields used in Cron expressions and examples of how to use them, see <a href="#">"Cron Expressions" on page 362</a> .
<b>Description</b>	A description of the scheduled job.
<b>Ends</b>	<p>Select one of the following options:</p> <ul style="list-style-type: none"> <li>• <b>Never.</b> Do not specify an end date.</li> <li>• <b>Until.</b> Choose the date and time by which you want the action to stop running.</li> </ul> <div style="background-color: #f0f0f0; padding: 10px; margin-top: 10px;"> <p><b>Note:</b> This element is not relevant if you define a report to run only once.</p> </div>

UI Element (A-Z)	Description
<b>Formats</b>	<p><b>Note:</b> Available only when defining a schedule for running reports.</p> <p>Select the format for the report. Available when you select the <b>Mail</b> or <b>Save to File System</b> options under Actions.</p> <p>The available options are:</p> <ul style="list-style-type: none"> <li>• <b>Excel.</b> The report data is formatted as an .xls (Excel) file that can be displayed in a spreadsheet.</li> <li>• <b>PDF.</b> The report data is exported in PDF format.</li> </ul> <p><b>Note:</b> When exporting to PDF, select a reasonable number of columns to display to ensure that the report is legible.</p> <ul style="list-style-type: none"> <li>• <b>CSV.</b> The report data is formatted as a comma-separated values (CSV) text file that can be displayed in a spreadsheet.</li> </ul> <p><b>Note:</b> For the CSV formatted table data to display correctly, the comma (,) must be defined as the list separator. In Windows, to verify or modify the list separator value, open Regional Options from the Control Panel, and on the Numbers tab ensure that the comma is defined as the List Separator value. In Linux, you can specify the list separator in the application that opens the CSV file.</p> <ul style="list-style-type: none"> <li>• <b>XML.</b> The report data is formatted as an XML file that can be opened in a text or XML editor.</li> <li>• <b>Direct Link.</b> Send an email containing the report data as a direct link. (Only relevant for the <b>Mail</b> option.)</li> </ul>
<b>Locale</b>	Select the language for the report.
<b>Name</b>	The name of the scheduled job.
<b>Repeat</b>	Select one of the following actions: <ul style="list-style-type: none"> <li>• <b>Once.</b> Activates a job only once.</li> <li>• <b>Interval.</b> Runs a job on the basis of a fixed interval. You can select an interval of minutes, hours, days, or weeks.</li> <li>• <b>Day of Month.</b> Runs a job every month on the selected dates.</li> </ul>

UI Element (A-Z)	Description
	<ul style="list-style-type: none"> <li>• <b>Weekly.</b> Runs a job on a weekly basis. Select the day or days on which you want the action to run.</li> <li>• <b>Monthly.</b> Runs a job on a monthly basis. Select the month or months in which you want the job to run.</li> <li>• <b>Yearly.</b> Runs a job on a yearly basis.</li> <li>• <b>Cron.</b> Use a Cron expression to schedule a job. For a description of the fields used in Cron expressions and examples of how to use them, see, "<a href="#">Cron Expressions</a>" on page 362.</li> </ul>
<b>Repeat every</b>	<p>(Appears only when you select <b>Interval</b> or <b>Yearly</b>.) Select a value for the interval between successive runs.</p> <p>For example, if you select <b>Yearly</b> and then <b>2</b>, the job runs every second year.</p>
<b>Repeat on</b>	<p>(Appears only when you select <b>Day of Month</b>, <b>Weekly</b>, or <b>Monthly</b>.) Select the days or dates on which to run the job.</p> <p>For example, if you select <b>Monthly</b> and then <b>January</b> and <b>July</b>, the job runs on the specified date and time in January and July.</p>
<b>Report</b>	<p>Enables you to select the Topology or Custom report you want to run. Opens the Select Report dialog box.</p>
<b>Send to</b>	<p><b>Note:</b> Available only when defining a schedule for running reports.</p> <p>Define the recipients who can automatically receive scheduled reports through mail. Click the <b>Open Address Book</b>  button to open the Message Recipients dialog box and select an mail recipient.</p> <p>You can use the <b>Add</b>, <b>Edit</b>, and <b>Delete</b> buttons in the Message Recipients dialog box to modify the mail list.</p> <p><b>Note:</b> The recipients that appear in the Message Recipients dialog box are updated with the email recipients defined in the Recipients Manager Page in the <i>HP Universal CMDB Administration Guide</i>.</p>
<b>Server Time</b>	<p>The exact server time according to the client's time zone.</p>
<b>Starts</b>	<p>Choose the time and date when you want the job to begin running.</p>
<b>Time Zone</b>	<p>Set the required time zone.</p>

## Service Discovery Errors Report

This report enables you to uncover specific problems that Data Flow Management encounters during a run, for example, incorrect credentials.

<p><b>To access</b></p>	<p>Select <b>Managers &gt; Modeling &gt; Reports</b>. In the <b>Custom Reports</b> pane, do one of the following:</p> <ul style="list-style-type: none"> <li>• Click the <b>Create New Report</b>  button and select <b>Service Discovery Errors Report</b>.</li> <li>• Under <b>Discovery Status</b>:             <ul style="list-style-type: none"> <li>◦ Double-click <b>Service Discovery Errors Report</b>.</li> <li>◦ Right-click <b>Service Discovery Errors Report</b> and select <b>Create New Report</b>.</li> <li>◦ Select <b>Service Discovery Errors Report</b>, and drag it onto the right pane.</li> </ul> </li> </ul>
<p><b>Important information</b></p>	<ul style="list-style-type: none"> <li>• Choose which columns to display by clicking the <b>Select Columns</b> button.</li> <li>• Hide a column by right-clicking its header and selecting <b>Remove Column</b>.</li> <li>• Hide empty columns by right-clicking a header and selecting <b>Remove Empty Columns</b>.</li> <li>• Change the order of columns by dragging and dropping a column header.</li> </ul>
<p><b>Relevant tasks</b></p>	<p><a href="#">"How to Generate a Custom Report" on page 358</a></p>
<p><b>See also</b></p>	<ul style="list-style-type: none"> <li>• Discovery Progress Dialog Box in the <i>HP Universal CMDB Data Flow Management Guide</i></li> <li>• Error Messages Overview in the <i>HP Universal CMDB Developer Reference Guide</i></li> </ul>

User interface elements are described below (unlabeled elements are shown in angle brackets):

<p><b>UI Element (A-Z)</b></p>	<p><b>Description</b></p>
<p>&lt;Shortcut Menu&gt;</p>	<p>Right-click a CI in the report to access the IT Universe Manager shortcut menu. For details, see <a href="#">"IT Universe Manager Shortcut Menu" on page 235</a>.</p>
<p>&lt;Toolbar&gt;</p>	<p>For details, see <a href="#">"Report Toolbar Options" on page 460</a>.</p>



UI Element (A-Z)	Description
<b>Generate</b>	Click to generate a list of errors.
<b>Service Discovery Activities</b>	Select the Service Discovery activities for which you want to generate error reports.
<b>Severity</b>	Select the types of error to display. For error definitions, see Error Severity Levels in the <i>HP Universal CMDB Developer Reference Guide</i> .  <div style="background-color: #f0f0f0; padding: 5px;"><b>Note:</b> You can select multiple error types.</div>
<b>Time range</b>	Select a time frame over which to display the errors. The system automatically provides the start and end dates in the <b>Date from</b> and <b>Date until</b> boxes.  <div style="background-color: #f0f0f0; padding: 5px;"><b>Note:</b> If you select <b>Custom</b>, you can manually configure a start and end date in the <b>Date from</b> and <b>Date until</b> boxes.</div>

The generated report includes the following elements (listed alphabetically):

UI Element (A-Z)	Description
<b>CI Type</b>	The CIT of the trigger CI.
<b>Error Message</b>	The detailed error message.
<b>Error Summary</b>	A brief summary of the error.
<b>Job</b>	The job for which the error was reported.
<b>Probe</b>	The Data Flow Probe that reported the error.
<b>Related IPs</b>	IPs known to be related to the trigger CI.
<b>Related Node</b>	The node that is related to the trigger CI.
<b>Severity</b>	The error severity level (Warning, Error, Fatal Error).
<b>Time Error Reported</b>	The time the error was reported.
<b>Trigger CI</b>	The trigger CI on which the error was reported.

## Software Utilization Report

This report displays all the installed software on the current machine with utilization data.

Group By:    
 Scope:    
 Show In-focus Utilization Only

[Software Utilization Report](#) [Installed Softwares On](#)

Display Label	DiscoveredVendor	Version	SoftwareLangu...	...	...	UsagePerc
Active Perl	ActiveState Software	5.8.3	English	0	0	37.81
FileZilla Client	GNU	3.3.1	English	0	0	0
Firefox	Mozilla	3.6.6	English	0	0	0
HP Asset Manager Application Designer	Hewlett-Packard	5.20	English	0	0	0
HP Asset Manager client	Hewlett-Packard	5.20	English	0	0	0
HP DDM Inventory Agent	Hewlett-Packard	9.30.000	English	0	0	37.81
Internet Explorer	Microsoft	8.0	English	0	0	0
Java 2 Runtime Environment	Oracle (Sun Microsystems)	1.5.0_19 SE	English	0	0	0
Java 2 SDK	Oracle (Sun Microsystems)	1.4.2_14-b05 SE	English	0	0	37.81
Java 2 SDK	Oracle (Sun Microsystems)	1.5.0_19 SE	English	0	0	0
Java SE Runtime Environment	Oracle	1.6.0_22	English	0	0	12.88

<p><b>To access</b></p>	<p>Select <b>Managers &gt; Modeling &gt; Reports</b>. In the <b>Custom Reports</b> pane, do one of the following:</p> <ul style="list-style-type: none"> <li>• Click the <b>Create New Report</b>  button and select <b>Software Utilization Report</b>.</li> <li>• Under <b>Inventory</b>:                     <ul style="list-style-type: none"> <li>◦ Double-click <b>Software Utilization Report</b>.</li> <li>◦ Right-click <b>Software Utilization Report</b> and select <b>Create New Report</b>.</li> <li>◦ Select <b>Software Utilization Report</b>, and drag it onto the right pane.</li> </ul> </li> </ul>
<p><b>Important information</b></p>	<p>The top level of the report displays the number of installed applications for each software type. You can drill down to view utilization data on specific software applications.</p> <p>Use the <b>Select Columns</b>  button to select the attributes to display in the report. When the report is grouped by Application Name or Vendor Name, a column called <b>Installed On</b> is available at the level of installed applications (after drilling down). The column displays the location where the software is installed and provides a clickable link to the node.</p>

	<p>When the report is grouped by Related Node, a column called <b>Installed Software</b> is available, which displays the number of installed applications on that node. It also provides a clickable link to drill down and display the applications' details.</p> <p>Applications with no utilization data do not appear in the report.</p>
<b>Relevant tasks</b>	<a href="#">"How to Generate a Custom Report" on page 358</a>



User interface elements are described below (unlabeled elements are shown in angle brackets):

<b>UI Element (A-Z)</b>	<b>Description</b>
<b>&lt;Breadcrumbs&gt;</b>	<p>Displays the levels through which you have navigated to get to the current level. Appears horizontally across the top of the chart.</p> <p><b>Note:</b> Each level in the list of breadcrumbs is a clickable link.</p>
<b>&lt;Shortcut Menu&gt;</b>	Right-click a CI in the report to access the IT Universe Manager shortcut menu. For details, see <a href="#">"IT Universe Manager Shortcut Menu" on page 235</a> .
<b>&lt;Toolbar&gt;</b>	For details, see <a href="#">"Report Toolbar Options" on page 460</a> .
<b>Group By</b>	<p>Select the method for displaying the data. The available options are:</p> <ul style="list-style-type: none"> <li>• Application Name</li> <li>• Vendor Name</li> <li>• Related Node</li> </ul>
<b>Scope</b>	<p>Select the scope of the report. The available options are:</p> <ul style="list-style-type: none"> <li>• <b>Last Month.</b> Displays applications with utilization data in the last month.</li> <li>• <b>Last Quarter.</b> Displays applications with utilization data in the last quarter.</li> <li>• <b>Last Year.</b> Displays applications with utilization data in the last year.</li> <li>• <b>All.</b> Displays all applications with utilization data.</li> </ul>
<b>Show In-focus Utilization Only</b>	<p>Select this check box to configure the report to display only the utilization data for the time that an application was in focus (when it was in the foreground).</p> <p>When the check box is cleared, the report displays utilization data for the time that an application was running (even when it was in the background).</p>

## Solaris Zone Report

This report displays information about Solaris zones. Solaris zones are isolated virtual environments running applications on one physical host machine.

Device	Zone Name	Operatin...	Status	Update Time
005056B85E7A_my-zone1	my-zone1		installed	Thu Apr 19 2012 10:16 AM IDT
twilightZone	twilightZone		running	Thu Apr 19 2012 10:16 AM IDT

<b>To access</b>	<p>Select <b>Managers &gt; Modeling &gt; Reports</b>. In the <b>Custom Reports</b> pane, do one of the following:</p> <ul style="list-style-type: none"> <li>• Right-click <b>Solaris Zone Report</b> and select <b>Create New Report</b>.</li> <li>• Click the <b>Create New Report</b>  button and select <b>Solaris Zone Report</b>.</li> <li>• Double-click <b>Solaris Zone Report</b>.</li> <li>• Select <b>Solaris Zone Report</b> and drag it onto the right pane.</li> </ul>
<b>Important information</b>	<p>The top level of the report displays information on the Solaris zones. Click the number in the Non-global Zone Count column to drill down to the next layer, which displays information on the non-global zones that are hosted on the global zone. In the second layer, you can click the number in the Network Devices column to drill down to the next layer and view information about the network devices available to this zone.</p> <p>Use the <b>Select Columns</b>  button to select the attributes to display in the report.</p>
<b>Relevant tasks</b>	<p><a href="#">"How to Generate a Custom Report" on page 358</a></p>

User interface elements are described below (unlabeled elements are shown in angle brackets>):

UI Element (A-Z)	Description
<Breadcrumbs>	<p>Displays the levels through which you have navigated to get to the current level. Appears horizontally across the top of the chart.</p> <p><b>Note:</b> Each level in the list of breadcrumbs is a clickable link.</p>
<Shortcut	<p>Right-click a CI in the report to access the IT Universe Manager shortcut menu. For</p>

UI Element (A-Z)	Description
Menu>	details, see <a href="#">"IT Universe Manager Shortcut Menu" on page 235.</a>
<Toolbar>	For details, see <a href="#">"Report Toolbar Options" on page 460.</a>

## Topology Report

This report displays the topology of a view in report format.

<b>To access</b>	Select <b>Modeling &gt; Reports</b> . In the <b>Topology Reports</b> pane, select the required report from the tree.
<b>Important information</b>	Every view in UCMDB can be displayed in report format. You define the settings for the report in the Report tab of the view in Modeling Studio.  Templates can be opened in Reports also. You can edit the template parameters and save the instance as a view.
<b>Relevant tasks</b>	<a href="#">"How to View a Topology Report" on page 357</a>

User interface elements are described below:

UI Element (A-Z)	Description
<Bar graph/Pie chart>	Each segment of the pie chart/column in a bar graph represents a CI on the selected level of the view.  Click a slice/bar to drill down to the next level, if one exists. You can also display the information in table format.  When you hold the mouse over the relevant segment/bar, a tooltip indicates the number of instances found for that CIT, the percentage of the pie it represents (when viewing the information in pie chart format), and the CIT or CIT attribute the slice/bar represents.
<Toolbar>	For details, see <a href="#">"Report Toolbar Options" on page 460.</a>
<b>Reset</b>	Resets the template parameters to their original values.  <b>Note:</b> Only relevant for templates.

UI Element (A-Z)	Description
<b>Save As View</b>	Click to save the instance as a template-based view with the selected parameter values.  <b>Note:</b> Only relevant for templates.

## View Change Report

This report displays the changes to CIs or relationships, in a selected view. This can help with possible troubleshooting issues related to these CIs. For example, the changes in a CI may enable you to conclude that these changes are the cause of the problem. By the same token, the source of the troubleshooting issue could be related to expected changes which failed to occur.

Display Label	Class Name	Attribute Name	New Value
16.59.70.0\abm1t21	Windows	DiscoveredOsName	Windows 2003
16.59.70.0\abm1t21	Windows	DiscoveredOsVersion	5.2.3790
16.59.70.0\abm1t21	Windows	Host Operating System Installation type	Server Enterprise
16.59.70.0\abm1t21	Windows	Host Operating System Release	3790
16.59.70.0\abm1t21	Windows	Windows Service Pack	2.0
16.59.70.0\abm1t21	Windows	Host is Desktop	False
16.59.60.0\vbto16	Windows	MemorySize	2,048
16.59.60.0\vbto16	Windows	DiscoveredOsName	Windows 2003 R2

<b>To access</b>	<p>Select <b>Modeling &gt; Reports</b>. In the <b>Custom Reports</b> pane, do one of the following:</p> <ul style="list-style-type: none"> <li>• Click the <b>Create New Report</b>  button and select <b>View Change Report</b>.</li> <li>• Under <b>Change</b>:                         <ul style="list-style-type: none"> <li>◦ Double-click <b>View Change Report</b>.</li> <li>◦ Right-click <b>View Change Report</b> and select <b>Create New Report</b>.</li> <li>◦ Select <b>View Change Report</b>, and drag it onto the right pane.</li> </ul> </li> </ul>
------------------	--

<p><b>Important information</b></p>	<p>Only those CIs whose properties are marked as <b>Managed</b> appear in the report. For details, see <a href="#">"Add/Edit Attribute Dialog Box" on page 497</a>.</p> <p>View Change reports display:</p> <ul style="list-style-type: none"> <li>• Changes on only CIs that exist in the view.</li> <li>• Changes that occurred in a selected CI and all children of the CI that are related by the relationship specified in the <b>Change Report link name</b> infrastructure setting. The default value of this setting is an empty value, (<b>managed_relationship</b>), that enables you to track changes of all relationship attributes that are not marked as <b>Not Tracked in History</b>.                      To change the CIs displayed in the generated report, go to <b>Managers &gt; Administration &gt; Infrastructure Settings</b> and edit the following settings:                     <ul style="list-style-type: none"> <li>◦ Select <b>Change Report link name</b> to retrieve CIs that are linked by the selected calculated relationship. Change the value of the setting to the name of the relationship as it appears in the <b>Name</b> box (not the <b>Display Name</b> box) in the Details page of the selected relationship in the CI Type Manager. For details, see <a href="#">"Details Page" on page 507</a>.</li> <li>◦ Select <b>Change Report link qualifier</b> to retrieve CIs that are defined with a qualifier. Change the value of the setting to the name of the required qualifier. For information about qualifiers, see <a href="#">"Qualifiers Page" on page 512</a>.</li> </ul> </li> <li>• CIs with a <b>Composition</b> relationship that were added to, or removed from, a CI.</li> </ul>
<p><b>Relevant tasks</b></p>	<p><a href="#">"How to Generate a Custom Report" on page 358</a></p>

User interface elements are described below:

<p><b>UI Element (A-Z)</b></p>	<p><b>Description</b></p>
<p><b>&lt;Shortcut Menu&gt;</b></p>	<p>Right-click a CI in the report to access the IT Universe Manager shortcut menu. For details, see <a href="#">"IT Universe Manager Shortcut Menu" on page 235</a>.</p>
<p><b>&lt;Toolbar&gt;</b></p>	<p>For details, see <a href="#">"Report Toolbar Options" on page 460</a>.</p>
<p><b>Date from</b></p>	<p>Configure a start date and time for the report.</p>
<p><b>Date until</b></p>	<p>Configure an end date and time for the report.</p>
<p><b>Time</b></p>	<p>Select a time frame over which to display the changes. The system automatically</p>

UI Element (A-Z)	Description
<b>range</b>	provides the starting and ending dates in the <b>Date from</b> and <b>Date until</b> boxes.  <div style="background-color: #f0f0f0; padding: 5px;"> <p><b>Note:</b> If you select <b>Custom</b>, you can manually configure a starting and ending date in the <b>Date from</b> and <b>Date until</b> boxes.</p> </div>
<b>View</b>	Select the view for which you want to review changes. Opens the Select CI/View dialog box. For details, see <a href="#">"Working with the CI Selector" on page 130</a> .

### CI Changes Tab

For information on the CI Changes tab, see ["CI Changes Tab" on page 383](#).

### Relationship Changes Tab

For information on the Relationship Changes tab, see ["Relationship Changes Tab" on page 384](#).

## VMware Host Report

This report displays information about the VMware hosts (VMware ESX servers) and the VMware virtual machines hosted on the ESX servers.

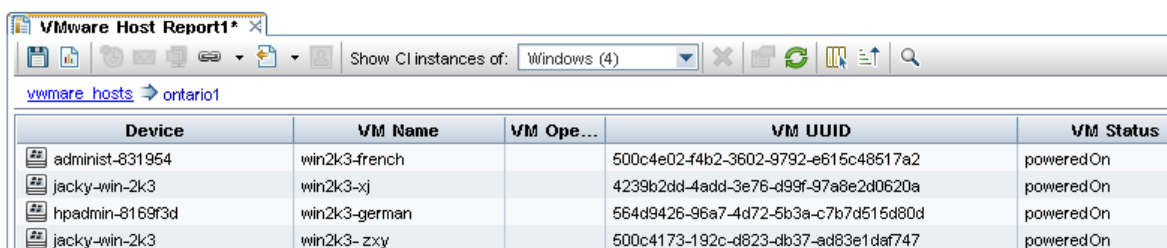

The screenshot shows a web browser window titled "VMware Host Report1\*" with a toolbar and a table of VM instances. The table has columns for Device, VM Name, VM Ope..., VM UUID, and VM Status. The data rows are as follows:

Device	VM Name	VM Ope...	VM UUID	VM Status
administ-831954	win2k3-french		500c4e02-f4b2-3602-9792-e615c48617a2	poweredOn
jacky-win-2k3	win2k3-xj		4239b2dd-4add-3e76-d99f-97a8e2d0620a	poweredOn
hpadmin-8169f3d	win2k3-german		564d9426-96a7-4d72-5b3a-c7b7d515d80d	poweredOn
jacky-win-2k3	win2k3-zxy		500c4173-192c-d823-db37-ad83e1daf747	poweredOn

<b>To access</b>	<p>Select <b>Managers &gt; Modeling &gt; Reports</b>. In the <b>Custom Reports</b> pane, do one of the following:</p> <ul style="list-style-type: none"> <li>Right-click <b>VMware Host Report</b> and select <b>Create New Report</b>.</li> <li>Click the <b>Create New Report</b>  button and select <b>VMware Host Report</b>.</li> <li>Double-click <b>VMware Host Report</b>.</li> <li>Select <b>VMware Host Report</b> and drag it onto the right pane.</li> </ul>
------------------	---



<b>Important information</b>	<p>The top level of the report displays information on each of the VMware hosts detected in the system. Click the number in the VM Count column to drill down to the next layer and view detailed information about all of that host's VMware virtual machines.</p> <p>Use the <b>Select Columns</b>  button to select the attributes to display in the report.</p>
<b>Relevant tasks</b>	<p><a href="#">"How to Generate a Custom Report" on page 358</a></p>

User interface elements are described below (unlabeled elements are shown in angle brackets):

UI Element (A-Z)	Description
<b>&lt;Breadcrumbs&gt;</b>	<p>Displays the levels through which you have navigated to get to the current level. Appears horizontally across the top of the chart.</p> <p><b>Note:</b> Each level in the list of breadcrumbs is a clickable link.</p>
<b>&lt;Shortcut Menu&gt;</b>	<p>Right-click a CI in the report to access the IT Universe Manager shortcut menu. For details, see <a href="#">"IT Universe Manager Shortcut Menu" on page 235</a>.</p>
<b>&lt;Toolbar&gt;</b>	<p>For details, see <a href="#">"Report Toolbar Options" on page 460</a>.</p>

## VMware Virtual Center Report

This report displays information about Virtual Centers, which manage the physical servers (VM hosts) and the virtual machines (VMs) they are running as a single, logical pool of resources.

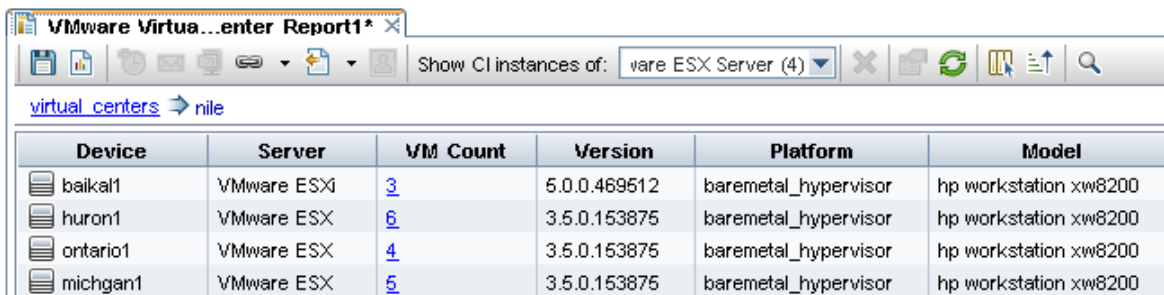

<b>To access</b>	<p>Select <b>Managers &gt; Modeling &gt; Reports</b>. In the <b>Custom Reports</b> pane, do one of the following:</p> <ul style="list-style-type: none"> <li>Right-click <b>VMware Virtual Center Report</b> and select <b>Create New Report</b>.</li> <li>Click the <b>Create New Report</b>  button and select <b>VMware Virtual Center</b></li> </ul>
------------------	---

	<p><b>Report.</b></p> <ul style="list-style-type: none"> <li>• Double-click <b>VMware Virtual Center Report</b>.</li> <li>• Select <b>VMware Virtual Center Report</b> and drag it onto the right pane.</li> </ul>
<b>Important information</b>	<p>The top level of the report displays information on the Virtual Centers. Click the number in the VMware Host Count column to drill down to the next layer, which displays information on each of the VMware hosts in that Virtual Center.</p> <p>In the second layer, you can click the number in the VM Count column to drill down to the next layer and view detailed information about all of that host's VMware virtual machines.</p> <p>Use the <b>Select Columns</b>  button to select the attributes to display in the report.</p>
<b>Relevant tasks</b>	<p><a href="#">"How to Generate a Custom Report" on page 358</a></p>

User interface elements are described below (unlabeled elements are shown in angle brackets):

<b>UI Element (A-Z)</b>	<b>Description</b>
<b>&lt;Breadcrumbs&gt;</b>	<p>Displays the levels through which you have navigated to get to the current level. Appears horizontally across the top of the chart.</p> <p><b>Note:</b> Each level in the list of breadcrumbs is a clickable link.</p>
<b>&lt;Shortcut Menu&gt;</b>	<p>Right-click a CI in the report to access the IT Universe Manager shortcut menu. For details, see <a href="#">"IT Universe Manager Shortcut Menu" on page 235</a>.</p>
<b>&lt;Toolbar&gt;</b>	<p>For details, see <a href="#">"Report Toolbar Options" on page 460</a>.</p>

## Zone-Based Discovery Errors Report

This report enables you to uncover specific problems that Data Flow Management encounters while running activities in the selected Management Zones, for example, incorrect credentials.

<b>To access</b>	<p>Select <b>Modeling &gt; Reports</b>. In the <b>Custom Reports</b> pane, do one of the following:</p> <ul style="list-style-type: none"> <li>• Click the <b>Create New Report</b>  button and select <b>Zone-Based Discovery Errors Report</b>.</li> <li>• Under <b>Discovery Status</b>:</li> </ul>
------------------	---

	<ul style="list-style-type: none"> <li>◦ Double-click <b>Zone-Based Discovery Errors Report</b>.</li> <li>◦ Right-click <b>Zone-Based Discovery Errors Report</b> and select <b>Create New Report</b>.</li> <li>◦ Select <b>Zone-Based Discovery Errors Report</b>, and drag it onto the right pane.</li> </ul>
<b>Important information</b>	<ul style="list-style-type: none"> <li>• Choose which columns to display by clicking the <b>Select Columns</b>  button.</li> <li>• Hide a column by right-clicking its header and selecting <b>Remove Column</b>.</li> <li>• Hide empty columns by right-clicking a header and selecting <b>Remove Empty Columns</b>.</li> <li>• Change the order of columns by dragging and dropping a column header.</li> </ul>
<b>Relevant tasks</b>	<a href="#">"How to Generate a Custom Report" on page 358</a>
<b>See also</b>	<ul style="list-style-type: none"> <li>• "Discovery Progress Dialog Box" in the <i>HP Universal CMDB Data Flow Management Guide</i></li> <li>• "Error Messages Overview" in the <i>HP Universal CMDB Developer Reference Guide</i></li> </ul>

User interface elements are described below (unlabeled elements are shown in angle brackets):

<b>UI Element (A-Z)</b>	<b>Description</b>
<b>&lt;Toolbar&gt;</b>	For details, see <a href="#">"Report Toolbar Options" on the next page</a> .
<b>Activity Type</b>	Select the type of discovery activity for which to display errors. To display all types of discovery activity errors, select <b>All</b> .
<b>Management Zones</b>	Select the Management Zones for which to display errors. You can select all Management Zones, or specific Management Zones.
<b>Generate</b>	Click to generate the report.
<b>Severity</b>	Select the types of error to display. For error definitions, see "Error Severity Levels" in the <i>HP Universal CMDB Developer Reference Guide</i> .  <b>Note:</b> You can select multiple error types.
<b>Time range</b>	Select a time frame over which to display the errors. The system automatically provides the start and end dates in the <b>Date from</b> and <b>Date until</b> boxes.





UI Element (A-Z)	Description
	<p><b>Note:</b> To manually customize the <b>Date from</b> and <b>Date until</b> values, select <b>Custom</b> from the <b>Time Range</b> list.</p>





The generated report includes the following elements (listed alphabetically):

UI Element (A-Z)	Description
<b>CI Type</b>	The CIT of the trigger CI.
<b>Error Message</b>	The detailed error message.
<b>Error Summary</b>	A brief summary of the error.
<b>Job</b>	The job for which the error was reported.
<b>Probe</b>	The Data Flow Probe that reported the error.
<b>Related IPs</b>	IPs known to be related to the trigger CI.
<b>Related Node</b>	The node that is related to the trigger CI.
<b>Severity</b>	The error severity level (Warning, Error, Fatal Error).
<b>Time Error Reported</b>	The time the error was reported.
<b>Trigger CI</b>	The trigger CI on which the error was reported.















## Report Toolbar Options





This section describes the toolbar options for the Report pane.

UI Element (A-Z)	Description
 Report Parameters	Displays the parameters that are defined for the report.
	<b>Save Report.</b> Saves the selected report.
	<b>Report Properties.</b> Opens the Report Properties dialog box, which enables you to set the report title, subtitle, and format.
	<p><b>Schedule Report.</b> Opens the Schedule Report dialog box, which enables you to define a job that:</p> <ul style="list-style-type: none"> <li>Schedules the generation of a report</li> </ul>

UI Element (A-Z)	Description
	<ul style="list-style-type: none"> <li>• Specifies one or more formats in which to send the report, and the report's recipients</li> <li>• Specifies the recurrence of the job</li> </ul> <p>For more information on the Schedule Report dialog box, see "<a href="#">Schedule Report/Snapshot Dialog Box</a>" on page 444.</p> <p><b>Note:</b> This option is only available before you generate a report or when you open a saved report.</p>
	<p><b>Send Mail.</b> Opens the Send Mail dialog box. You can send an email containing the generated report in various formats, or as a direct link. For details on the various formats, see "<a href="#">Report Toolbar Options</a>" on the previous page.</p> <p>Select one or more of the available formats for the generated report to be sent as attachments to an email recipient.</p> <p><b>Note:</b></p> <ul style="list-style-type: none"> <li>• Required fields are marked with an asterisk.</li> <li>• In the Send Mail dialog box, the <b>From</b> field is populated with the email address defined in the user details for the current user. If no email is defined for the current user, the default email address of the customer is used.</li> </ul>
	<p><b>Archive Report.</b> Enables you to save the report results in the database. After the report is archived, the <b>Archive Report</b>  button appears next to the report name.</p> <p><b>Note:</b> Enabled only for Topology and Gold Master reports.</p>
	<p><b>Generate Direct Link.</b> Creates a direct link to the specific location on the server of the selected report, or to the data that you have exported as a specific format.</p>
	<p><b>Export Report.</b></p> <p>Enables you to select the format for previewing and exporting the report. The available options are:</p> <ul style="list-style-type: none"> <li>• <b>CSV.</b> The report data is formatted as a comma-separated values (CSV)</li> </ul>

UI Element (A-Z)	Description
	<p>text file that can be displayed in a spreadsheet.</p> <p><b>Note:</b> For the CSV formatted table data to display correctly, the comma (,) must be defined as the list separator. In Windows, to verify or modify the list separator value, open Regional Options from the Control Panel, and on the Numbers tab ensure that the comma is defined as the List Separator value. In Linux, you can specify the list separator in the application that opens the CSV file.</p> <ul style="list-style-type: none"> <li>• <b>PDF.</b> The report data is exported in PDF format.</li> </ul> <p><b>Note:</b> When exporting to PDF, select a reasonable number of columns to display to ensure that the report is legible.</p> <ul style="list-style-type: none"> <li>• <b>XLS.</b> The report data is formatted as an .xls (Excel) file that can be displayed in a spreadsheet.</li> </ul> <p><b>Note:</b> For large reports, you can reduce the time required for exporting the report by setting a fixed column size using the <b>Column Size For XLS Export</b> setting in the Infrastructure Settings Manager.</p> <ul style="list-style-type: none"> <li>• <b>XML.</b> The report data is formatted as an XML file that can be opened in a text or XML editor.</li> </ul> <p><b>Tip:</b> To extract HTML code from the report:</p> <ul style="list-style-type: none"> <li>• Open the file in an HTML editor</li> <li>• Copy the relevant table into the target file</li> </ul>
	<p><b>Assign Tenants.</b> Opens the Assign Tenants dialog box which enables you to assign tenants to the selected custom report.</p> <p><b>Note:</b></p> <ul style="list-style-type: none"> <li>• This option is only available for saved reports.</li> <li>• This option is only available when multi-tenancy is enabled.</li> </ul>

UI Element (A-Z)	Description
	<p><b>Manage Security.</b> Enables you to assign permission for the report to specific roles or to add the report to selected resource groups.</p> <p><b>Note:</b> This option is only available for saved reports.</p>
 Bar Chart	<p><b>Bar Chart.</b> Displays the generated report as a bar chart.</p>
 Pie Chart	<p><b>Pie Chart.</b> Displays the generated report as a pie chart.</p>
 Table	<p><b>Table.</b> Displays the generated report in tabular format.</p>
	<p><b>Show Short Labels.</b> Toggles between displaying the chart labels minimal/maximum information.</p> <p><b>Note:</b> This option is available only for pie charts.</p>
	<p><b>Show Legend.</b> Toggles between hiding and displaying the chart's legend.</p> <p><b>Note:</b> This option is available only for pie charts.</p>
	<p><b>Slice chart.</b> Toggles between displaying the pie chart with exploded and unexploded segments.</p> <p><b>Note:</b> This option is available only for pie charts.</p>
	<p><b>Expand All.</b> Expands the tree structure.</p>
	<p><b>Collapse All.</b> Collapses the tree structure.</p>
	<p><b>Delete from CMDB.</b> Deletes the selected CI from the CMDB.</p>
	<p><b>Properties.</b> Opens the Configuration Item Properties dialog box for the selected CI.</p>
	<p><b>Refresh.</b> Refreshes the report tree.</p>
	<p><b>Select Columns.</b> Enables you to select the columns you want to display in the report. For details, see <a href="#">"Select Columns Dialog Box" on page 571</a>.</p>
	<p><b>Sort Column Content.</b> Enables you to set the sort order of the selected column's content.</p>

UI Element (A-Z)	Description
	<p><b>Find.</b> Toggles between displaying and hiding the Find utility.</p>
	<p><b>Find the next occurrence of the phrase/Find the previous occurrence of the phrase.</b> Enables you to move to the next or previous result of the search for the string entered in the <b>Find</b> field.</p>
	<p><b>Highlights all occurrences of the phrase.</b> Highlights all occurrences in the CI tree of the string entered in the <b>Find</b> field.</p>
	<p><b>Generate Report.</b> Enables you to generate the selected report.</p> <p><b>Note:</b> This button appears disabled prior to defining the report parameters.</p>
<p><b>&lt;breadcrumbs&gt;</b></p>	<p>Displays the levels through which you have navigated to get to the current level. Appears horizontally across the top of the chart.</p> <p><b>Note:</b> Each level in the list of breadcrumbs is a clickable link.</p>
<p><b>&lt;Generated report&gt;</b></p>	<p>Displays the active generated report.</p>
<p><b>Find</b></p>	<p>Enter a search name or a portion of a search name in the <b>Find</b> field to locate it in the list.</p>

## Reports on Non-English Locales – Notes and Limitations

- HP Universal CMDB does not support custom report names that contain more than 50 multi-byte characters.
- If a report is created in one language locale and sent by email from another language locale, the report contains system information in the languages of the server and the original locale.
- If a report file name contains multi-byte characters (for example, in Japanese, Chinese, or Korean) and the report is sent as an email attachment, the name becomes unreadable.
- When exporting a CI instance to a PDF file, multi-byte characters (such as Japanese, Chinese, Korean, and so on) may not be displayed properly in the PDF file.
- When saving a snapshot of a topology report, the name can have a maximum of 25 non-English characters.





# Chapter 10: Impact Analysis Manager

This chapter includes:

Impact Analysis Manager Overview .....	466
How to Define an Impact Rule – Workflow .....	467
Impact Analysis Manager User Interface .....	470

## Impact Analysis Manager Overview

Impact Analysis Manager enables you to define the interdependencies between components in your IT infrastructure to simulate how infrastructure changes (for example, a new software installation or upgrade) can impact your system.

By creating Impact rules based on TQL queries, you can determine the true origin of a problem and its business impact. Each Impact rule you define is attached to a specific Impact Analysis TQL query. For more information about TQL queries, see ["Topology Query Language" on page 14](#).

You define Impact rules to specify a causal relationship between two or more Impact Analysis query nodes. Define one query node as the trigger, or the query node that represents the changes you want to make to the system, and another query node as the one that is impacted. After the causal relationship is established, Impact Analysis Manager enables you to determine the effect of the changes occurring in root cause query nodes.

You then run the Impact rules in IT Universe Manager to simulate how the changes impact your system and discover the root causes of the changes (for details, see ["Run Impact Analysis Dialog Box" on page 247](#)). This enables you to evaluate and handle accordingly, the possible implications of any action, update, new deployment, or a failure of the service delivery.

A simulated change in an impacted CI can alter the CI's map status, which is manifested through an addition of a status icon to the CI's symbol. The Topology Map displays the statuses of the trigger CIs as well as all statuses of the CIs that are impacted by it. Each color represents a different status.

For details about the status icons and the colors that represent them, see ["Show Impact Pane" on page 251](#).

You can then generate a report displaying the following:

- CIs in the system that are impacted by the changes.
- Trigger CIs (the CIs that represent the changes you want to make to the system).
- CIs that belong to a specific business service.

## How to Define an Impact Rule – Workflow

This section describes how to define an Impact rule whereby a change in CPU operation impacts the node to which it is connected.

This task includes the following steps:

- ["Create an Impact Analysis TQL Query" below](#)
- ["Define an Impact Rule" on the next page](#)

### 1. Create an Impact Analysis TQL Query

To create an Impact Analysis TQL query, you need to create an Impact Analysis TQL and then add the TQL query nodes and relationships that define the query.

Select **Managers > Modeling > Impact Analysis Manager** to open the Impact Analysis Manager. For details about how to create an Impact Analysis TQL query, see ["New Impact Rule/Impact Rule Properties/Save As Impact Rule Wizard" on page 480](#). For details about how to add query nodes and relationships to a query, see ["How to Add Query Nodes and Relationships to a TQL Query" on page 26](#).

#### **Example of an Impact Analysis TQL Query:**

In this Impact Analysis TQL query, a CPU and a node are linked by a Composition relationship. The TQL query results must comply with the direction of the arrows.

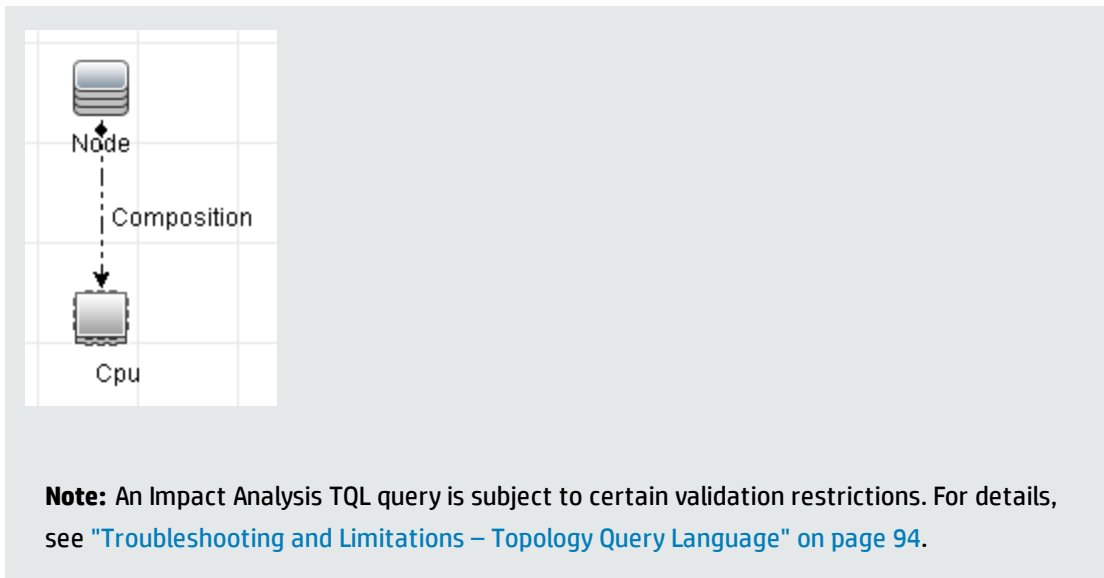

## 2. Define an Impact Rule

When you define an Impact rule, you must specify the required causal relationship between the query nodes. Define one query node as the trigger, or the query node that represents the changes you want to make to the system, and another query node as the one that is impacted.

Right-click the query node you want to define as the trigger query node and select **Define Impacted** to open the Impacted Query Nodes dialog box. Select the query node you want the trigger query node to impact. Then click the **Add** button to open the Impact Rules Definition dialog box to set conditions for defining impacted query nodes. For details about how to define an Impact rule, see ["Impact Rules Definition Dialog Box" on page 479](#).

**Note:** The **change** state option in the Impact rule definition is no longer relevant for Impact Analysis. The only supported state is **operation**.

### Example of an Impact Rule:

The Conditions area in the Impact Rules Definition dialog box defines the conditions under which the simulated change in the system is triggered. The Severity area defines the severity of the impact on the impacted query node.

The Impact rule in this example states that when the CPU operation is not in the normal state, the node is impacted. Since the severity is set to 100% of the trigger's severity, the severity of the node is the same as the severity of the CPU, which is determined when Impact Analysis is run.

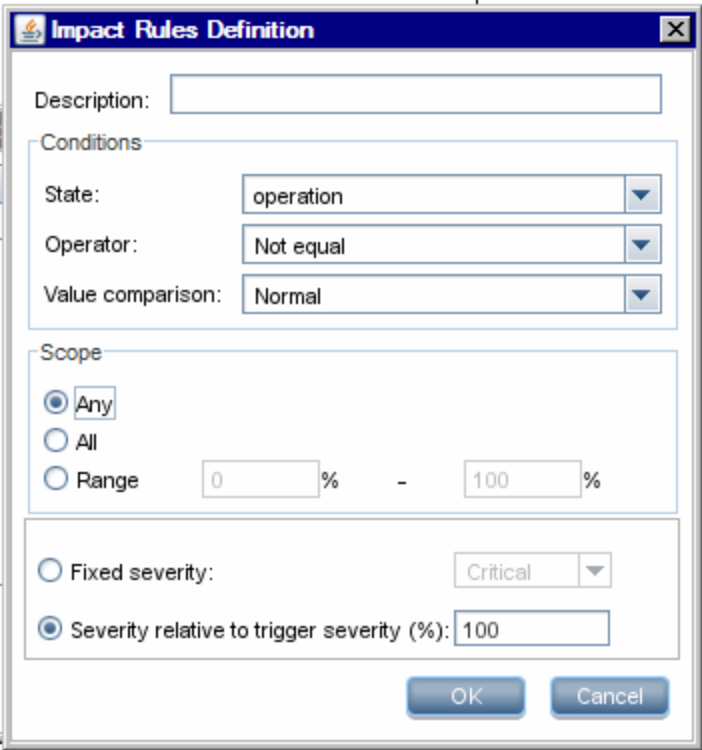

In the resulting TQL query, an upward arrow appears next to the query node defined as the trigger query node and a downward arrow appears next to the query node defined as the impacted query node.

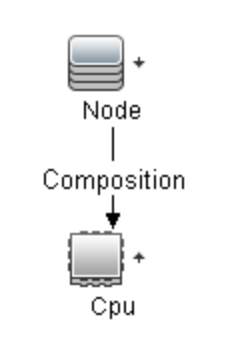

**Note:** To retrieve the Impact Analysis results, you must run the Impact rule in IT Universe Manager. For details, see ["How to Retrieve Impact Analysis Results – Scenario" on page 207](#).

## Impact Analysis Manager User Interface

This section includes (in alphabetical order):

Details Dialog Box .....	470
Impact Analysis Manager Page .....	470
Impacted Query Nodes Dialog Box .....	478
Impact Rules Definition Dialog Box .....	479
New Impact Rule/Impact Rule Properties/Save As Impact Rule Wizard .....	480

### Details Dialog Box

This dialog box displays the new Impact rule you created in the Impact Rules Definition dialog box.

<b>To access</b>	In the Impact Analysis Manager, click <b>Next</b> in the Impacted Query Nodes dialog box.
<b>Relevant tasks</b>	<a href="#">"How to Define an Impact Rule – Workflow" on page 467</a>
<b>See also</b>	<ul style="list-style-type: none"> <li>• <a href="#">"Impact Analysis Manager Overview" on page 466</a></li> <li>• <a href="#">"Impact Analysis Manager User Interface" above</a></li> </ul>

User interface elements are described below:

UI Element (A-Z)	Description
<b>Description</b>	The description of the new Impact rule.
<b>State</b>	The category you chose from the <b>State</b> list in the Impact Rules Definition dialog box.

### Impact Analysis Manager Page

This page enables you to define Impact rules.

<b>To access</b>	Select <b>Impact Analysis Manager</b> from the Navigation Menu or select <b>Managers &gt; Modeling &gt; Impact Analysis Manager</b> .
<b>Important</b>	When selecting query nodes to function as Impact Analysis triggers, they must comply







<b>information</b>	with certain restrictions. For details, see <a href="#">"Troubleshooting and Limitations – Topology Query Language"</a> on page 94.
<b>Relevant tasks</b>	<a href="#">"How to Define an Impact Rule – Workflow"</a> on page 467
<b>See also</b>	<ul style="list-style-type: none"> <li>• <a href="#">"Impact Analysis Manager Overview"</a> on page 466</li> <li>• <a href="#">"Impact Analysis Manager User Interface"</a> on the previous page</li> </ul>







## Impact Rules Pane

This area displays a hierarchical tree structure of predefined folders and Impact rules. Each Impact rule is associated with a TQL query.

<b>Important information</b>	<p>You can create your own Impact rules, or work with the default rules provided with your HP Universal CMDB installation.</p> <p>The predefined folders are provided for the default Impact rules; you can modify these folders, or add additional folders according to your organization's requirements.</p> <p>You can drag and drop Impact rules or folders to move them from one folder to another.</p>
------------------------------	--

User interface elements are described below:

UI Element (A-Z)	Description
	<b>New Folder.</b> Creates a new folder.
	<b>New.</b> Creates an Impact rule. Opens the New Impact Rule Wizard.
	<b>Delete.</b> Deletes the selected folder or Impact rule.
	<b>Refresh.</b> Refreshes the data content of the hierarchical tree structure that may have been modified by other users.
	<b>Save.</b> Saves the Impact rule to the CMDB. (Enabled only when a new Impact rule is created or when changes are made to an existing one.)
	<b>Properties.</b> Opens the Impact Rule Properties Wizard. Enables you to change the description of the rule.

UI Element (A-Z)	Description
	<p><b>Assign Tenants.</b> Opens the Assign Tenants dialog box which enables you to assign tenants to the impact rule.</p> <p><b>Note:</b> This button is only available when multi-tenancy is enabled.</p>
	<p><b>Manage Security.</b> Enables you to assign the selected impact rule to specific roles or resource groups.</p>
	<p><b>Preview.</b> Generates a preview of the results of the selected Impact rule.</p>
	<p><b>Export To XML.</b> Enables you to export an Impact rule to an XML file.</p>
	<p><b>Import From XML.</b> Enables you to import XML files that contain saved Impact rules to the Impact Analysis Manager.</p>
	<p>Represents a folder.</p>
	<p>Represents an Impact rule.</p>
<b>&lt;Impact Rules tree&gt;</b>	<p>Displays the existing Impact rules in tree format.</p> <p><b>Note:</b> Only Impact rules appear in the tree. TQL queries of type Impact Analysis (created in the Modeling Studio) do not appear.</p>

The following options are available by right-clicking a folder or Impact rule:

UI Element (A-Z)	Description
<b>Assign Tenants</b>	<p>Opens the Assign Tenants dialog box which enables you to assign tenants to the selected impact rule.</p> <p><b>Note:</b> This option is only available when multi-tenancy is enabled.</p>
<b>Delete</b>	<p>Delete the selected folder or Impact rule.</p>
<b>Export To XML</b>	<p>Displays a standard Save As dialog box, enabling you to save the Impact rule as an XML script. This option can be used to move an Impact rule from one workstation to</p>





UI Element (A-Z)	Description
	another, provided the related TQL query is also relocated.
<b>Import From XML</b>	Imports XML files that contain saved Impact rules to Impact Analysis Manager.
<b>Manage Security</b>	Assign the selected impact rule to specific roles or resource groups.
<b>New</b>	Creates an Impact rule. Opens the New Impact Rule Wizard.
<b>New Folder</b>	Creates a new folder.
<b>Preview</b>	Generates a preview of the results of the selected Impact rule.
<b>Properties</b>	Opens the Impact Rule Properties Wizard. Enables you to change the description of the rule.
<b>Rename Folder</b>	Rename the folder.
<b>Save</b>	(Enabled only when a new Impact rule is created or when changes are made to an existing one.) Saves the Impact rule to the CMDB.
<b>Save As</b>	Displays the Save As Impact Rule Wizard, enabling you to create new Impact rules based on an existing query.

## Editing Pane

This area displays the selected Impact rule, which consists of query nodes that are defined in the TQL query and the relationships between them.

<b>Important information</b>	<ul style="list-style-type: none"> <li>When you select a folder in the Impact Rules pane, the editing pane is empty.</li> <li>When you select an Impact rule in the Impact Rules pane, the editing pane displays the selected rule, which consists of TQL query nodes that are defined in the TQL query and the relationships between them.</li> </ul>
<b>Relevant tasks</b>	<a href="#">"How to Add Query Nodes and Relationships to a TQL Query" on page 26</a>
<b>See also</b>	When selecting query nodes to function as Impact Analysis triggers, they must comply with certain restrictions. For details, see <a href="#">"Troubleshooting and Limitations – Topology Query Language" on page 94</a> .

User interface elements are described below (unlabeled elements are shown in angle brackets):

UI Element (A-Z)	Description
	Indicates a trigger query node. Located to the right of the trigger query node's icon.
	Indicates an impacted query node. Located to the right of the impacted query node's icon.
	Indicates query nodes that are both impacted and trigger query nodes.
<Main Menu>	For details, see <a href="#">"Main Menu" on page 164</a> .
<Query Node>	A component from which TQL queries are built.
<Relationship>	The entity that defines the relationship between two query nodes.
<Shortcut menu options>	For details, see <a href="#">"Shortcut Menu Options" on page 34</a> .
<Toolbar>	For details, see <a href="#">"Toolbar Options" on page 168</a> .
<Tooltip>	<p>Hold the cursor over a query node or relationship to view its tooltip.</p> <p>The tooltips contain the following information:</p> <ul style="list-style-type: none"> <li>• <b>Element name.</b> The name of the query node.</li> <li>• <b>CI Type.</b> The CIT of the query node as defined in the CI Type Manager. For details, see <a href="#">"CI Type Manager" on page 485</a>.</li> <li>• <b>Definitions of the selected query nodes and relationships.</b> The attribute conditions, as described in <a href="#">"Query Node/Relationship Properties Dialog Box" on page 73</a>.</li> <li>• <b>Names of the trigger and the impacted query nodes.</b> This is only relevant if the query node over which the cursor is hovering is the trigger query node.</li> </ul>





## CI Type Selector

This area displays a hierarchical tree structure of the CI Types found in the CMDB.

<b>Important information</b>	<p>The CI Type Selector is part of Enrichment Manager, Impact Analysis Manager, and Trigger TQL Editor.</p> <p>To create or modify a TQL query, click and drag query nodes to the Editing pane and define the relationship between them. Your changes are saved to the CMDB. For</p>
------------------------------	--

	<p>details, see <a href="#">"How to Add Query Nodes and Relationships to a TQL Query"</a> on page 26.</p> <div style="background-color: #f0f0f0; padding: 5px;"> <p><b>Note:</b> The number of instances of each CIT in the CMDB is displayed to the right of each CIT.</p> </div>
<b>Relevant tasks</b>	<ul style="list-style-type: none"> <li>• <a href="#">"How to Define an Impact Rule – Workflow"</a> on page 467</li> <li>• <a href="#">"How to Define an Enrichment Rule – Scenario"</a> on page 531</li> <li>• <a href="#">"How to Define a TQL Query"</a> on page 24</li> <li>• <a href="#">"How to Create a Pattern View"</a> on page 271</li> </ul>

User interface elements are described below (unlabeled elements are shown in angle brackets):

UI Elements (A-Z)	Description
	<b>Add CI Type to Map.</b> Moves the selected CI type to the Editing pane.
	<b>Refresh.</b> Refreshes the CI type tree.
	<b>Search.</b> Searches for the CI type entered.
	<b>Expand All.</b> Expands all subtrees within the CI type tree.
	<b>Collapse All.</b> Collapses the subtrees within the CI type tree.
<Search window>	Enter the name or part of a name of a CI type for which to search.

### Shortcut Menu Options

The CI Type Selector includes the following elements (listed alphabetically) available by right-clicking a CI Type:



Menu Item	Description
<b>Add CI Type to Map</b>	Select to add the selected CI type to the Editing pane.
<b>Go to CI Type Definition</b>	Takes you directly to the selected CI type in CIT Manager.
<b>Show CIT Instances</b>	Opens the CIT Instances window, which displays all instances of the selected CIT. For details, see <a href="#">"CI Instances Dialog Box"</a> on page 66.

## Advanced Pane

This area displays the properties, conditions, and cardinality for the selected query node and relationship.

<b>Important information</b>	The Advanced pane appears in the lower part of the window in the following managers and user interfaces: Modeling Studio, Impact Analysis Manager, Enrichment Manager, the Input Query Editor and Trigger Query Editor in DFM.  A small green indicator  appears next to the tabs that contain data.
<b>Relevant tasks</b>	<ul style="list-style-type: none"> <li>• <a href="#">"How to Define an Impact Rule – Workflow" on page 467</a></li> <li>• <a href="#">"How to Define an Enrichment Rule – Scenario" on page 531</a></li> <li>• <a href="#">"How to Define a TQL Query" on page 24</a></li> <li>• <a href="#">"How to Create a Pattern View" on page 271</a></li> <li>• <a href="#">"How to Create a Template" on page 273</a></li> <li>• <a href="#">"How to Create a Perspective" on page 274</a></li> </ul>

User interface elements are described below:

<b>UI Elements (A-Z)</b>	<b>Description</b>
	If the window is not wide enough to display all the tabs, use the left and right arrows to move to the required tab.
	Click <b>Show List</b> to display a list of the available tabs for the current module. You can select a tab from the list.
<b>Attributes</b>	Displays the attribute conditions defined for the query node or the relationship. For details, see <a href="#">"Attribute Tab" on page 75</a> .
<b>Cardinality</b>	Cardinality defines how many query nodes you expect to have at the other end of a relationship. For example, in a relationship between a node and an IP Address, if the cardinality is 1:3, the TQL query retrieves only those nodes that are connected to between one and three IP Addresses. For details, see <a href="#">"Cardinality Tab" on page 78</a> .
<b>Data Sources</b>	Displays the data sources set for the selected query node.

UI Elements (A-Z)	Description
	<p><b>Note:</b> This tab appears only in the Modeling Studio.</p>
<p><b>Details</b></p>	<p>Displays the following information:</p> <ul style="list-style-type: none"> <li>• <b>CI Type/Element Type.</b> The CIT of the selected query node/relationship.</li> <li>• <b>Element Name.</b> The name of the query node or relationship. This appears only in the Modeling Studio.</li> <li>• <b>Show in query results.</b> A green check indicates that the selected query node/relationship is visible in the topology map. A red mark indicates that it is not visible. In the Modeling Studio, this is indicated by the word Yes or No.</li> <li>• <b>Include subtypes.</b> A green check indicates that both the selected CI and its children are displayed in the topology map. A red mark indicates that only the selected CI appears. This item does not appear in the Modeling Studio.</li> </ul>
<p><b>Edit</b></p>	<p>Click <b>Edit</b> to open the relevant dialog box for the selected tab.</p>
<p><b>Element Layout</b></p>	<p>Displays the attributes selection for the selected query node or relationship. It lists the attributes selected to be included in the query results (when <b>Specific Attributes</b> is selected as the attributes condition). It also lists the excluded attributes and any selected qualifiers for attributes. For details, see <a href="#">"Element Layout Tab" on page 83</a>.</p> <p><b>Note:</b> This tab appears only in the Modeling Studio.</p>
<p><b>Element Type</b></p>	<p>Displays the subtype conditions defined for the query node or relationship. For details, see <a href="#">"Element Type Tab" on page 81</a>.</p> <p><b>Note:</b> This tab appears only in the Modeling Studio.</p>
<p><b>Enrichment Rules</b></p>	<p>Displays the Enrichment rule defined for the selected query node or relationship. If the Enrichment rule is used to update the attributes of a CI, click <b>Edit</b> to open the Query Node/Relationship Definition dialog box and edit the rule if required. For details, see <a href="#">"Query Node/Relationship Definition Dialog Box" on page 555</a>.</p> <p><b>Note:</b> This tab appears only in Enrichment Manager.</p>
<p><b>Impacted</b></p>	<p>Indicates which query node is impacted by the changes that occur in the selected</p>

UI Elements (A-Z)	Description
<b>Query Nodes</b>	trigger query node. If required, you can click <b>Edit</b> to open and modify the Impacted Query Nodes dialog box. For details, see <a href="#">"Impacted Query Nodes Dialog Box"</a> below.  <b>Note:</b> This tab appears only in Impact Analysis Manager.
<b>Qualifiers</b>	Displays the qualifier conditions defined for the query node or the relationship. For details, see <a href="#">"Qualifier Tab"</a> on page 85.  <b>Note:</b> This tab appears only in Enrichment Manager and Impact Analysis Manager.
<b>Selected Identities</b>	Displays the element instances that are used to define what should be included in the TQL query results. For details, see <a href="#">"Identity Tab"</a> on page 86.

## Impacted Query Nodes Dialog Box

This dialog box enables you to define which query node in the TQL query is the trigger Impact Analysis query node and which query nodes are impacted by the changes that occurred in the system.

<b>To access</b>	Right-click the query node or relationship that functions as a trigger and select Define Impacted. The Impacted Query Nodes dialog box opens to display the query nodes in the TQL query.
<b>Important information</b>	Before creating the TQL query, you must know which query node in the query is the trigger Impact Analysis query node and which are impacted by the changes beforehand. The definition is performed here.
<b>Relevant tasks</b>	<a href="#">"How to Define an Impact Rule – Workflow"</a> on page 467
<b>See also</b>	<ul style="list-style-type: none"> <li>• <a href="#">"Impact Analysis Manager Overview"</a> on page 466</li> <li>• <a href="#">"Impact Analysis Manager User Interface"</a> on page 470</li> </ul>

User interface elements are described below :

UI Element (A-Z)	Description
<b>Impacted</b>	Contains a list of the Impact Analysis query nodes in the Impact rule. Select the query

UI Element (A-Z)	Description
<b>Query Nodes pane</b>	nodes to be impacted by the trigger query node. Click <b>Next</b> to view details for the selected query node.

## Impact Rules Definition Dialog Box

This dialog box enables you to set conditions for defining impacted query nodes, define the scope of the trigger conditions, and define the severity of the impact.

<b>To access</b>	In the Impact Analysis Manager, click <b>Add</b> on the Details page of the Impacted Query Nodes dialog box.
<b>Important information</b>	<ul style="list-style-type: none"> <li>• In the Conditions area, set conditions for defining impacted query nodes. When this condition is met, the simulated change in the system is triggered.  For example, you can define an Impact Analysis condition that states that the operational state of the query node is other than Normal. When the operational state of the query node instance changes and is no longer Normal, the condition is met and the simulated changes in the system are triggered.</li> <li>• In the Scope area, define how many instances of the trigger query node should fulfill the conditions for triggering the changes in the system.  You can apply the trigger conditions to a single instance of a trigger query node, to a certain percentage of the trigger instances, or to all of them.  For example, you can define that impact is calculated when at least 10% of the system's nodes are down.</li> <li>• In the Severity area, define the severity of the Impact Analysis impact.</li> </ul>
<b>Relevant tasks</b>	<a href="#">"How to Define an Impact Rule – Workflow" on page 467</a>
<b>See also</b>	<ul style="list-style-type: none"> <li>• <a href="#">"Impact Analysis Manager Overview" on page 466</a></li> <li>• <a href="#">"Impact Analysis Manager User Interface" on page 470</a></li> </ul>

User interface elements are described below :

UI Element (A-Z)	Description
<b>All</b>	All instances should fulfill the conditions.
<b>Any</b>	One instance or more should fulfill the conditions.
<b>Description</b>	A description of the Impact rule you are defining.
<b>Fixed severity</b>	Define a fixed severity level for every system change generated. Then, select the required severity level from the list.
<b>Function</b>	Select <b>Function</b> (displayed when you selected the <b>All</b> and <b>Range</b> options in the <b>Scope</b> area) to define a severity level for the system changes, as a function of the severity levels of all the trigger query node instances that are included in the range. From the list, select either <b>Average</b> or <b>Max</b> .  For example, if you select <b>Average</b> , the severity level of the system changes is the average severity of all the trigger instances.
<b>Operator</b>	Select the required operator. For a list of the operators you can use for defining an attribute condition, see " <a href="#">Attribute Operator Definitions</a> " on page 40.
<b>Range</b>	A certain percentage of all instances should fulfill the conditions. For example, if you enter a range of 50% to 100%, the changes are triggered when 50% or more of the instances meet the conditions.
<b>Severity relative to trigger severity (%)</b>	Select <b>Severity relative to trigger severity (%)</b> (displayed when you selected the <b>Any</b> option in the <b>Scope</b> area) to define a severity level for each system change that is relative (as a percentage) to the severity of the trigger event.  Enter the percentage in the box provided.
<b>State</b>	Choose the required state. The states that appear in the list are the states that are defined in the State Manager. For details, see "State Manager" in the <i>HP Universal CMDB Administration Guide</i> .
<b>Value comparison</b>	Select the required attribute.

## New Impact Rule/Impact Rule Properties/Save As Impact Rule Wizard

This wizard enables you to create or modify an Impact rule.

<b>To access</b>	<ul style="list-style-type: none"> <li>To create an Impact rule, right-click anywhere in the Impact Rules pane and click</li> </ul>
------------------	---



	<p><b>New</b> or click the <b>New</b>  button.</p> <ul style="list-style-type: none"> <li>To modify an Impact rule, right-click an Impact rule in the Impact Rules pane and select <b>Properties</b>.</li> <li>To create a new Impact rule based on an existing query, right-click an Impact rule in the Impact Rules pane and select <b>Save As</b>.</li> </ul>
<b>Important information</b>	<ul style="list-style-type: none"> <li>Any major change made to the TQL query after creating an Impact rule causes the system to delete the rule. These changes include deleting a root cause or impacted query node or changing the <b>Min</b> and <b>Max</b> relationship definitions. For details, see <a href="#">"Cardinality Tab" on page 78</a>.</li> <li>Minor changes, such as adding a query node to the TQL query, do not cause the deletion of the rule.</li> <li>The Impact Analysis TQL query that serves as the basis of the Impact rule, is subject to certain validation restrictions. For details, see <a href="#">"Troubleshooting and Limitations – Topology Query Language" on page 94</a> . If the TQL query is not valid, it cannot be used for the creation of an Impact rule.</li> </ul>
<b>Relevant tasks</b>	<p><a href="#">"How to Define an Impact Rule – Workflow" on page 467</a>.</p>
<b>Wizard Map</b>	<p>The <a href="#">"New Impact Rule/Impact Rule Properties/Save As Impact Rule Wizard"</a> contains:  <a href="#">"Impact Rule General Attributes Page"</a> below &gt; <a href="#">"Impact Rule Base Query Page"</a> on the next page &gt; <a href="#">"Impact Rule Groups Page"</a> on page 483</p>
<b>See also</b>	<ul style="list-style-type: none"> <li><a href="#">"Impact Analysis Manager Overview" on page 466</a></li> <li><a href="#">"Impact Analysis Manager User Interface" on page 470</a></li> </ul>

## Impact Rule General Attributes Page

This wizard page enables you to enter a unique name and description for the Impact rule.

<b>Important information</b>	<ul style="list-style-type: none"> <li>The Impact Analysis TQL query that serves as the basis of the Impact rule, is subject to certain validation restrictions. For details, see <a href="#">"Troubleshooting and Limitations – Topology Query Language" on page 94</a>. If the TQL query is not valid, it cannot be used for the creation of an Impact rule.</li> <li>For important information on the effects of making changes to the TQL query after creating it, see <a href="#">"New Impact Rule/Impact Rule Properties/Save As Impact Rule Wizard" on the previous page</a>.</li> </ul>
------------------------------	---

	<ul style="list-style-type: none"> <li>By default, this wizard is set to display a Welcome page. You can choose not to display the Welcome page by changing the user preferences. For details, see <a href="#">"User Preferences Dialog Box"</a> on page 93.</li> </ul>
<b>Wizard map</b>	<p>The <a href="#">"New Impact Rule/Impact Rule Properties/Save As Impact Rule Wizard"</a> on page 480 contains:</p> <p><a href="#">"Impact Rule General Attributes Page"</a> &gt; <a href="#">"Impact Rule Base Query Page"</a> &gt; <a href="#">"Impact Rule Groups Page"</a></p>
See also	<a href="#">"IT Universe Manager"</a> on page 181

User interface elements are described below:

UI Element (A-Z)	Description
<b>Rule Description</b>	(Optional) Enter a description of the Impact rule.
<b>Rule Name</b>	<p>Enter a unique name for the Impact rule.</p> <p>The rule name cannot contain any of the following characters: \ / : " &lt; &gt;   % ?. The final character cannot be a blank space.</p> <p><b>Note:</b> If the Impact rule name is either empty, contains a name used by another Impact rule, or uses invalid characters, the <b>Next</b> and <b>Finish</b> buttons are disabled.</p>

## Impact Rule Base Query Page

This wizard page enables you to define the properties of the TQL query on which the Impact rule is based. You can use an existing query or create a new query.

<b>Important information</b>	<ul style="list-style-type: none"> <li>The Impact Analysis TQL query that serves as the basis of the Impact rule is subject to certain validation restrictions. For details, see <a href="#">"Troubleshooting and Limitations – Topology Query Language"</a> on page 94. If the TQL query is not valid, it cannot be used for the creation of an Impact rule.</li> <li>For important information on the effects of making changes to the TQL query after creating it, see <a href="#">"New Impact Rule/Impact Rule Properties/Save As Impact Rule Wizard"</a> on page 480.</li> </ul>
<b>Wizard map</b>	<p>The <a href="#">"New Impact Rule/Impact Rule Properties/Save As Impact Rule Wizard"</a> contains:</p> <p><a href="#">"Impact Rule General Attributes Page"</a> &gt; <a href="#">"Impact Rule Base Query Page"</a> &gt; <a href="#">"Impact</a></p>

	<a href="#">Rule Groups Page</a>
<b>See also</b>	<a href="#">"IT Universe Manager" on page 181</a>

User interface elements are described below :

UI Element (A-Z)	Description
<b>Base the Impact rule on a new query</b>	Select this check box if you want to base the Impact rule on a new TQL query. The query results are based on the attributes defined for the new TQL query.
<b>Base the Impact rule on an existing query</b>	Select this check box if you want to base the Impact rule on an existing TQL query. Select the required Impact Analysis TQL query from the drop-down list.
<b>Base Query Description</b>	(Optional) Enter a description of the TQL query.
<b>Base Query Name</b>	Enter a unique name for the Impact Analysis TQL query.  If you selected the <b>Base the Impact rule on an existing TQL</b> option, select the Impact Analysis TQL query on which you want to base the rule.
<b>Save a new query based on the current definition</b>	Select to save a new TQL query based on your Impact rule definition.  <b>Note:</b> This field only appears in the Save As Impact Rule wizard.

## Impact Rule Groups Page

This wizard page enables you to define where you can run Impact rules.

<b>Important information</b>	<ul style="list-style-type: none"> <li>The Impact Analysis TQL query that serves as the basis of the Impact rule, is subject to certain validation restrictions. For details, see <a href="#">"Troubleshooting and Limitations – Topology Query Language" on page 94</a>. If the TQL query is not valid, it cannot be used for the creation of an Impact rule.</li> <li>For important information on the effects of making changes to the TQL query after creating it, see <a href="#">"New Impact Rule/Impact Rule Properties/Save As Impact Rule Wizard" on page 480</a>.</li> <li>By default, this wizard is set to display a Completion page after clicking <b>Next</b> on this page. You can choose not to display the Completion page by changing the user preferences. For details, see <a href="#">"User Preferences Dialog Box" on page 93</a>.</li> </ul>
<b>Wizard map</b>	The <a href="#">"Impact Rule Groups Page"</a> contains:

	"Impact Rule General Attributes Page" > "Impact Rule Base Query Page" > " <b>Impact Rule Groups Page</b> "
<b>See also</b>	"IT Universe Manager" on page 181

User interface elements are described below :

UI Element (A-Z)	Description
<b>&lt;Impact Rule bundles&gt;</b>	<p>Displays the available bundles. Select the bundle(s) in which to include this Impact Rule.</p> <p>For new Impact rules, the <b>UCMDB: Rule will run within UCMDB application</b> option is selected by default.</p>

# Chapter 11: CI Type Manager

This chapter includes:

CI Types Overview .....	485
CI Type Attributes .....	486
CI Type Relationships .....	488
Deprecated CI Types .....	488
System Type Manager .....	489
How to Create a CI Type .....	490
How to Create a Relationship Type .....	492
How to Create a Calculated Relationship Type .....	493
How to Create List and Enumeration Definitions .....	494
How to Create an Enumeration Definition – Workflow .....	494
View Descriptions for CI Types and Relationships .....	496
CI Type Manager User Interface .....	497

**Note to HP Software-as-a-Service customers:** The data in CI Type Manager can be viewed but not edited.

## CI Types Overview

A configuration item (CI) can represent hardware, software, services, business processes, or any component of your IT infrastructure. CIs with similar properties are grouped under a CI type (CIT). Each CIT provides a template for creating a CI and its associated properties.

Every CI must belong to a CI type. The following are the main categories of CITs:

- **Business Element.** CITs that correspond to the logical elements of your business, such as processes and organizational groups.
- **IT Process Record.** CITs that correspond to changes that occur in your IT infrastructure.

- **Monitor.** CITs that handle incoming metrics collected from your business universe.
- **Location.** CITs that correspond to the location of devices and business organizations or people supporting a function.
- **Party.** CITs that correspond to an active entity such as a person or organization.
- **CI Collection.** A logical collection of CIs.
- **Infrastructure Element.** CITs that correspond to the physical elements (hardware and software) installed in your business environment.

The CITs are arranged in a tree structure under these categories in the CI Types pane. You can browse the CI Type model by expanding the tree in the CI Types pane. The CIT selected in the left pane is displayed in the topology map along with all the potential valid relationships to other CITs.

You can also define new CITs to match your business needs. For details on defining new CITs, see ["Create Configuration Item Type/Relationship/Calculated Relationship Wizard" on page 506](#).

## CI Type Attributes

Every CI type has attributes which define it, such as name, description, and default value. The CITs grouped under other CITs in the CI Type tree inherit attributes from the higher-level CITs.

When you define a new CI type, you first select a Base Configuration Item Type from a list of existing CITs. Your new CIT inherits the attributes of the existing CIT. You can then set the attributes for the new CIT. You edit the attributes of an existing CIT by selecting a CIT from the tree in the CI Types pane and selecting the Attributes tab of the topology map. For details on CIT attributes, see ["Attributes Page" on page 508](#).

This section includes the following topics:

- ["CI Type Identification Methods" below](#)
- ["CI Type Naming" on the next page](#)

### CI Type Identification Methods

Every CI created is given an automatically generated global ID, which is used to distinguish different instances of the same CI type. UCMDB provides identification methods which enable you to set conditions under which two CI instances are defined as identical, and are consequently merged into a

single instance. For example, the **By key attributes** method involves defining CIs with certain matching attributes to be identical. You can also select additional identification methods as described in ["Details Page" on page 507](#).

If you select the **By key attributes** option, you can designate one or more of the CIT's attributes as key attributes, which are used as identifiers of the CIT. When you define an instance of a CIT, the CIT's key attributes are mandatory fields for CIs of that type. You can assign as many key attributes as you want to a given CIT. If you do not assign a key attribute when defining a new CIT or changing the identification method of an existing CIT to **By key attributes**, you must select the ABSTRACT\_CLASS qualifier on the Qualifier page of the wizard.

You can change or remove the key attributes of an existing CIT if the key attribute values for all instances of that CIT are unique. Similarly, you can change the identification method to **By key attributes** only if the key attribute values for all instances of that CIT are unique. If the selected changes result in multiple instances of a CIT with identical key attribute values, an error message indicates that the action is not permitted, as the CIT instances would be merged.

If you select other identification methods, you cannot define key attributes for the CIT, but it retains the key attributes of its parent CIT. These key attributes are mandatory fields for CIs of that type and they cannot be removed. For those identification methods, there are no restrictions on the qualifiers selected.

Identification is also relevant for CIs of sibling CI types, if at least one of the CI types inherits its identification method from the common ancestor CIT. For example, the CI types **Router** and **Switch Router** are sibling CI types, descendants of the ancestor CIT **Node**. If at least one of them has **Inherited from parent** as the identification method, then CIs of the two types could be merged if the identification criteria are met. In such a case, the CI type of the merged CI is that of the sibling that was most recently updated. If one of the CIs had attributes that do not exist in the CI type of the merged CI, they are filtered out of the merged CI.

## CI Type Naming

Entity names in HP Universal CMDB for CMDB-based applications follow the conventions described below:

- **CIT attributes values.** All primitive types are supported: long, double, float, string, and so on.
- **CIT attributes values-type string.** All special characters are supported. The maximum length is 4000 characters.
- **CIT name.** Only the following characters are permitted: a-z, A-Z, 0-9 and underscore (\_). Note also:

- The first character must not be a number.
- The name field is case sensitive, but you cannot use the same name with different cases for different CITs.
- The maximum length is 200 characters.
- **CIT attribute name.** Only the following characters are permitted: a-z, A-Z, 0-9 and underscore (\_).  
Note also:
  - The first character may be a number.
  - The attribute name field is not case sensitive.
  - The maximum length is 200 characters.
- **CIT attribute length.** The total length of all the attribute values in one CIT cannot exceed 8K bytes due to a Microsoft SQL Server limitation. This limitation is relaxed under certain circumstances. For details, see <http://msdn.microsoft.com/en-us/library/ms186981.aspx>.

## CI Type Relationships

A relationship defines the link between two CIs. Relationships represent the dependencies and connections between the entities in your IT environment. When you select relationships or calculated relationships in the drop-down box in the CI Types pane, the topology map displays all the valid instances of CITs linked by the selected relationship. For details about calculated relationships, see "[Using Calculated Relationships](#)" on page 99.

The same attributes defined for CITs are also defined for relationships. You can also assign key attributes for relationships but it is not required. For details on defining new relationship types, see "[Create Configuration Item Type/Relationship/Calculated Relationship Wizard](#)" on page 506.

## Deprecated CI Types

CITs and relationships that are scheduled to be removed in a subsequent product version are known as deprecated CITs. Such CITs appear in the user interface in strikethrough font. You can hold the pointer over a deprecated CIT to display a tooltip with information about it, including which CIT replaces it.



**Note:** The strikethrough font is only visible when a font size of 14 points or higher is selected for the topology map.

Deprecated CITs appear in the CIT tree in Modeling Studio; however, it is not recommended to use them in building new TQL queries and views. In place of a deprecated CIT, use the CIT indicated in the tooltip as its replacement. Deprecated CITs do not appear in out-of-the-box queries and views.

CIT attributes which are scheduled to be removed are deprecated attributes. They also appear in strikethrough font in the user interface.

The following image displays a TQL query containing a deprecated CIT:

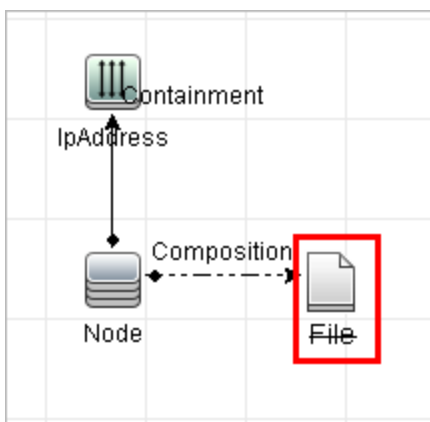

## System Type Manager

System Type Manager enables you to create a predefined list whose values define an attribute type. For more information, see ["System Type Manager Dialog Box" on page 527](#).

You can create the following attribute types:

- **List.** Enables you to create a predefined list of values, for example, Location.
- **Enumeration.** Enables you to create a predefined list of values, as well as assign each value a color. Enumerations are designed to be used as severity value lists by states. For details, see "State Manager" in the *HP Universal CMDB Administration Guide*.

Severity lists are used for:

- Retrieving Impact Analysis results in IT Universe Manager. For details, see ["IT Universe Manager" on](#)

[page 181](#).

- [Creating an Impact rule](#). For details, see ["Impact Analysis Manager" on page 466](#).

You can use both List and Enumeration values for:

- [Editing the attributes of a CIT](#). For details, see ["How to Create a CI Type" below](#).
- [Defining an attribute condition for a TQL query node or relationship](#). For details, see ["Query Node/Relationship Properties Dialog Box" on page 73](#).

## How to Create a CI Type

This task describes the process you follow to create a CIT using the Create CI Type wizard.

This task includes the following steps:

- ["Prerequisites" below](#)
- ["Define the CI Type" below](#)
- ["Set the CI Type Attributes" on the next page](#)
- ["Assign Qualifiers to the CI Type" on the next page](#)
- ["Assign an Icon to the CI Type" on the next page](#)
- ["Customize the CI Type Menu" on the next page](#)
- ["Define the CI Type Default Label" on the next page](#)
- ["Define the Matching Rules" on the next page](#)

### 1. Prerequisites

From the CI Type Manager, select **CI Types** from the list box in the CI Types pane. Then click **New**



to start the Create CI Type Wizard.

### 2. Define the CI Type

Enter the name, description, and base configuration item type for the new CI type and select an

identification method for it. For details, see ["Details Page" on page 507](#).

### 3. **Set the CI Type Attributes**

Edit the attributes of the new CI type. For details, see ["Attributes Page" on page 508](#).

**Note:** List and Enumeration definitions are created in the System Type Manager. If required, you can create additional List and Enumeration definitions. For details, see ["How to Create List and Enumeration Definitions" on page 494](#).

### 4. **Assign Qualifiers to the CI Type**

Assign qualifiers to the definition of the new CI type. For details, see ["Qualifiers Page" on page 512](#).

### 5. **Assign an Icon to the CI Type**

Select an icon to assign to the new CI type. For details, see ["Icon Page" on page 515](#).

### 6. **Customize the CI Type Menu**

Select the menu items and commands to appear in the shortcut menu for the new CI type. For details, see ["Attached Menu Page" on page 516](#).

### 7. **Define the CI Type Default Label**

Define the attributes to appear in the CI type label. For details, see ["Default Label Page" on page 519](#).

### 8. **Define the Matching Rules**

If necessary, define the matching rules for the new CI type. For details, see ["Matching Rules Page" on page 521](#).

**Note:** This step is only relevant for customers running HP Universal CMDB Configuration Manager.

## How to Create a Relationship Type

This task describes the process you follow to create a relationship type using the Create Relationship wizard.

This task includes the following steps:

- ["Prerequisites" below](#)
- ["Define the Relationship" below](#)
- ["Set the Relationship Attributes" below](#)
- ["Assign Qualifiers to the Relationship" below](#)
- ["Customize the Relationship Menu" on the next page](#)
- ["Define the Relationship Default Label" on the next page](#)

### 1. Prerequisites

From the CI Type Manager, select **Relationships** from the list box in the CI Types pane. Then click **New**  to start the Create Relationship Wizard.

### 2. Define the Relationship

Enter the name, description and base CI type for the new relationship. For details, see ["Details Page" on page 507](#).

### 3. Set the Relationship Attributes

Edit the attributes of the new relationship. For details, see ["Attributes Page" on page 508](#).

**Note:** List and Enumeration definitions are created in the System Type Manager. If required, you can create additional List and Enumeration definitions. For details, see ["How to Create List and Enumeration Definitions" on page 494](#).

### 4. Assign Qualifiers to the Relationship

Assign qualifiers to the definition of the new relationship. For details, see ["Qualifiers Page" on](#)

[page 512](#).

### 5. **Customize the Relationship Menu**

Select the menu items and commands to appear in the shortcut menu for the new relationship. For details, see ["Attached Menu Page" on page 516](#).

### 6. **Define the Relationship Default Label**

Define the attributes to appear in the relationship label. For details, see ["Default Label Page" on page 519](#).

## How to Create a Calculated Relationship Type

This task describes the process you follow to create a calculated relationship type using the Create Calculated Relationship wizard.

This task includes the following steps:

- ["Prerequisites" below](#)
- ["Define the Calculated Relationship" below](#)
- ["Assign Qualifiers to the Relationship" below](#)
- ["Add Required Triplets" on the next page](#)

### 1. **Prerequisites**

From the CI Type Manager, select **Calculated Relationships** from the list box in the CI Types pane.

Then click **New**  to start the Create Calculated Relationship Wizard.

### 2. **Define the Calculated Relationship**

Enter the name, description and base CI type for the new calculated relationship. For details, see ["Details Page" on page 507](#).

### 3. **Assign Qualifiers to the Relationship**

Assign qualifiers to the definition of the new relationship. For details, see ["Qualifiers Page" on](#)

[page 512.](#)

#### 4. **Add Required Triplets**

Add the required triplets. For details, see ["Triplets Page" on page 514.](#)

## How to Create List and Enumeration Definitions

This section describes the tasks for creating List and Enumeration definitions.

This task includes the following steps:

- ["Create a List Definition" below](#)
- ["Create an Enumeration Definition" below](#)

### 1. **Create a List Definition**

You can create a **List** definition of predefined values. For example, a List definition called Location might contain:

- New York
- Boston
- Baltimore

For details, see ["Create/Update List/Enumeration Definition Dialog Box" on page 522.](#)

### 2. **Create an Enumeration Definition**

You can create an **Enumeration** definition, which enables you to assign a color for each value on the list. For details, see ["Create/Update List/Enumeration Definition Dialog Box" on page 522.](#) For an example of an Enumeration definition, see ["How to Create an Enumeration Definition – Workflow" below.](#)

## How to Create an Enumeration Definition – Workflow

The following steps describe how to create an Enumeration definition.

**Note:** To retrieve the required results, you must follow each step in this task.

**To create an Enumeration definition:**



1. Select **Managers > Modeling > CI Type Manager**.
2. From the Main Menu, select **CI Types > System Type Manager** to open the System Type Manager dialog box.
3. Click the **Add**  button to open the Create List Definition dialog box.

**Note:** Alternatively, you can select **Managers > Administration > State Manager** and then click the **New Enumeration** button to open the Create Enumeration Definition dialog box.

4. Select **Enumeration**.
5. In the **Name** box, enter the required name.
6. (Optional) In the **Display Name** box, enter the required display name.

This example describes how to create the following severity list:

Key	Value	Severity Represented
0	Green	Normal
1	Orange	Major
2	Red	Critical

7. Click the **Add**  button to create a new row.
8. In the **Value** box, enter `Normal`, in the **Key** box, enter `0`, and in the **Color** section, select **Green**.
9. Click the **Add**  button to create another row.
10. In the **Value** box, enter `Major`, in the **Key** box, enter `1`, and in the **Color** section, select **Orange**.
11. Click the **Add**  button to create another row.
12. In the **Value** box, enter `Critical`, in the **Key** box, enter `2`, and in the **Color** section, select **Red**.

The following image shows the Enumeration Definition section after the changes:

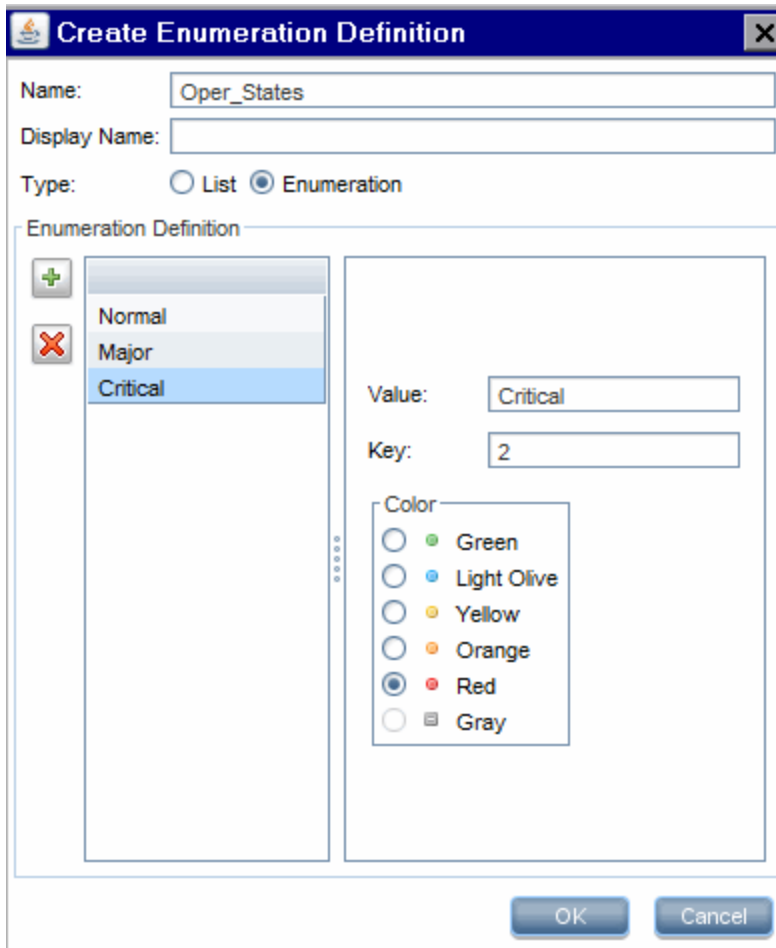

13. Click **OK** to save your changes.

## View Descriptions for CI Types and Relationships

You can view a complete list of available CI types in tree format in the left pane of CI Type Manager. You can search incrementally for a specific CI type as described in ["CI Type Manager Page" on page 502](#). To see a description for a particular CI type, select it from the tree and hold the pointer over the icon which corresponds to it in the Topology Map. A tooltip containing a description of the CI type is displayed.

For relationships, select **Relationships** in the left pane and search incrementally by the first letter of the relationship. Select the relationship you want and hold the pointer over its icon in the Topology Map to display a tooltip containing a description of the relationship.



For detailed information on CI types and relationships, you can generate the UCMDB CI Types and Relationships Information PDF. For details, see ["Export Selected CITs to PDF Dialog Box" on page 526](#). Alternatively, you can access the UCMDB Class Model Reference by clicking the **View UCMDB Class**

**Model**  button on the CI Types pane toolbar.

## CI Type Manager User Interface

This section includes (in alphabetical order):

Add/Edit Attribute Dialog Box .....	497
Add/Remove Relationship Dialog Box .....	501
CI Type Manager Page .....	502
Create Configuration Item Type/Relationship/Calculated Relationship Wizard .....	506
Create/Update List/Enumeration Definition Dialog Box .....	522
Export Selected CITs to Excel Dialog Box .....	525
Export Selected CITs to PDF Dialog Box .....	526
System Type Manager Dialog Box .....	527

### Add/Edit Attribute Dialog Box

This dialog box enables you to define a new attribute to add to a CIT or to edit an existing attribute of a CIT.

<b>To access</b>	In the CI Type Manager, select the Attributes tab, then click the <b>Add</b>  button, or select an attribute and click the <b>Edit</b> button or double-click the attribute.
<b>Important information</b>	In Edit mode, fields that cannot be changed are disabled. For CI types with instances, some fields cannot be edited. For details, see <a href="#">"Attributes Page" on page 508</a> .
<b>Relevant tasks</b>	<ul style="list-style-type: none"> <li>• <a href="#">"How to Create a CI Type" on page 490</a></li> <li>• <a href="#">"How to Create a Relationship Type" on page 492</a></li> </ul>
<b>See also</b>	<ul style="list-style-type: none"> <li>• <a href="#">"CI Types Overview" on page 485</a></li> <li>• <a href="#">"CI Type Attributes" on page 486</a></li> </ul>

## Details Tab

User interface elements are described below:

UI Element (A-Z)	Description
<b>Attribute Name</b>	Enter a unique name for the new attribute. Only the following characters are permitted: a-z, A-Z, 0-9 and underscore (_). Note also: <ul style="list-style-type: none"> <li>• The first character may be a number.</li> <li>• The attribute name field is not case sensitive.</li> <li>• The maximum length is 200 characters.</li> </ul>
<b>Attribute Type</b>	Select one of the following options: <ul style="list-style-type: none"> <li>• <b>Primitive.</b> Choose from one of the following field types: boolean, bytes, date number, double number, float number, integer, list of integers, list of strings, long number, string, xml.</li> <li>• <b>Enumeration/List.</b> Contains a list of Enumerations and Lists defined in the System Type Manager. For details, see "<a href="#">System Type Manager</a>" on page 489.</li> </ul> <p>This option enables you to define an attribute with a predefined value. For example, a location attribute might be defined by a <b>location</b> list containing the following values: Singapore, Paris, New York.</p>
<b>Default Value</b>	Enter or select a default value for the attribute. The options for the <b>Default Value</b> field vary depending on the attribute type you selected. <div style="background-color: #f0f0f0; padding: 10px; margin-top: 10px;"> <p><b>Note:</b></p> <ul style="list-style-type: none"> <li>• The <b>Default Value</b> field is available only when the <b>Default Value Policy</b> check box is selected.</li> <li>• If you select the <b>Primitive</b> attribute types list of integers or list of strings, you can enter multiple values.</li> </ul> </div>
<b>Default Value Policy</b>	Select the check box to specify whether the attribute will have a default value.
<b>Description</b>	Enter a description for the new attribute. The description can be up to 2,048 characters long.

UI Element (A-Z)	Description
	<b>Note:</b> This field is optional.
<b>Display Name</b>	Enter a name for the new attribute to identify it in HP Universal CMDB.  <b>Note:</b> This field is optional.
<b>Scope</b>	Select the scope of the new attribute (the class model to which it belongs).
<b>Value Size</b>	Enter a value for the maximum physical size of the new attribute. (Enabled for bytes and string only).

### Advanced Tab

User interface elements are described below:

UI Element (A-Z)	Description
<b>Asset Data</b>	Select to display the attribute value in the Asset Report.
<b>Comparable</b>	Select to enable this attribute to be used for comparing compound CIs.
<b>Discovery Auto Trim</b>	When selected, results sent from the Probe are trimmed. That is, leading and trailing spaces and tabs are trimmed, so that there are no white spaces at the beginning or at the end of the result.
<b>Discovery Auto Truncate</b>	If selected, when attributes of type STRING exceed the size limit, Discovery truncates the value. For details, see Server-Side Data Normalization in the <i>HP Universal CMDB Data Flow Management Guide</i> .
<b>Editable</b>	Select to enable future editing of the attribute. Only attributes that are marked as <b>Editable</b> (or ones that have values) are displayed in the Properties tab in IT Universe Manager.
<b>Index</b>	Select to accelerate the attribute retrieval performance. This option is recommended for attributes that are used frequently in search conditions. For example, IP address is usually an index attribute of a node.
<b>Lower Case</b>	When this option is selected, the attribute value appears in lower case.
<b>Managed</b>	This designation is only relevant for users of HP Universal CMDB Configuration

UI Element (A-Z)	Description
	Manager.  <b>Note:</b> <ul style="list-style-type: none"> <li>When this qualifier is selected for a given attribute, the attribute appears as a visible column in the CI Instances dialog box. For details, see "<a href="#">CI Instances Dialog Box</a>" on page 66.</li> <li>Managed is not relevant for attributes of the type list of integers or list of strings.</li> </ul>
<b>Not Tracked for History</b>	Select to exclude this attribute from History storage.
<b>Password</b>	When this option is selected, the attribute value appears as asterisks (a hidden value).
<b>Required</b>	Select to define this attribute as a required one, if its value is required for the creation of the CIT.
<b>Static</b>	Select to define this attribute as static.
<b>Unique</b>	When this option is selected, different instances of this CI type must have unique values.
<b>Upper Case</b>	When this option is selected, the attribute value appears in upper case.
<b>Use Update Value Policy</b>	For details on this qualifier, see " <a href="#">The Use Update Value Policy Qualifier</a> " on page 23.
<b>Visible</b>	Select to display this attribute in the Properties tab in IT Universe Manager.

### UCMDB Browser Qualifiers

User interface elements are described below:

UI Element (A-Z)	Description
<b>CMS Browser Editable</b>	Select to enable this attribute to be editable in the UCMDB Browser.

UI Element (A-Z)	Description
<b>CMS Browser Searchable</b>	Select to enable this attribute to be searchable in the UCMDB Browser.
<b>CMS Browser Visible</b>	Select to enable this attribute to be viewed in the UCMDB Browser.  The <b>Visible in preview mode</b> field determines whether the attribute is displayed in preview mode of the UCMDB Browser.  The <b>Properties group assignment</b> field determines the group in the properties widget where the attribute is displayed.
<b>Hide in Modeling</b>	When <b>CMS Browser Visible</b> is selected, select <b>Hide in Modeling</b> to prevent the attribute from appearing in the Assisted Modeling feature in the UCMDB Browser.
<b>Hide in Export Search Results</b>	Select to enable this attribute to be excluded from exported search results in the UCMDB Browser.

## Add/Remove Relationship Dialog Box

This dialog box enables you to add or remove default or new relationships between CITs, which define their physical or logical connections.

<b>To access</b>	In the CI Type Manager, right-click a CIT or two CITs and select <b>Add/Remove Relationship</b> .
<b>Important information</b>	When adding a relationship between two CITs, select the two CITs to be linked by holding the <b>CTRL</b> key and clicking the CIT names. Then right-click one of them and select <b>Add/Remove Relationship</b> .
<b>See also</b>	<ul style="list-style-type: none"> <li>• <a href="#">"CI Types Overview" on page 485</a></li> <li>• <a href="#">"CI Type Relationships" on page 488</a></li> </ul>

User interface elements are described below (unlabeled elements are shown in angle brackets):

UI Element (A-Z)	Description
<b>&lt;query node1 to query node2&gt;</b>	Select the relationships to add in the direction of the first query node to the second.
<b>&lt;query node2 to query node1&gt;</b>	Select the relationships to add in the direction of the second query node to the first.

UI Element (A-Z)	Description
<b>Relationship Name</b>	A list of the possible relationships.







## CI Type Manager Page

This page enables you to view the information in the CI Type model, which contains the definitions of all configuration item types (CITs) defined in the system and the relationships that define the connections between them. Each CIT has its own attributes, as well as the attributes inherited from its parent CIT.

<b>To access</b>	Select <b>CI Type Manager</b> from the Navigation Menu or select <b>Managers &gt; Modeling &gt; CI Type Manager</b> .
<b>Important information</b>	<p>CI Type Manager consists of the following panes:</p> <ul style="list-style-type: none"> <li>• <b>CI Types.</b> Displays a hierarchical list of CI Types and relationships. The number appearing next to the CIT indicates the number of instances of that CIT which exist in the CMDB.</li> <li>• <b>Topology Map.</b> Displays a topology map of the CITs and relationships in the system.</li> </ul>
<b>Relevant tasks</b>	<ul style="list-style-type: none"> <li>• <a href="#">"How to Create a CI Type" on page 490</a></li> <li>• <a href="#">"How to Create a Relationship Type" on page 492</a></li> <li>• <a href="#">"How to Create a Calculated Relationship Type" on page 493</a></li> </ul>
<b>See also</b>	<ul style="list-style-type: none"> <li>• <a href="#">"CI Types Overview" on page 485</a></li> <li>• <a href="#">"CI Type Attributes" on page 486</a></li> <li>• <a href="#">"CI Type Relationships" on page 488</a></li> <li>• <a href="#">"Deprecated CI Types" on page 488</a></li> <li>• <a href="#">"View Descriptions for CI Types and Relationships" on page 496</a></li> <li>• <a href="#">"CI Type Manager User Interface" on page 497</a></li> </ul>

User interface elements are described below (unlabeled elements are shown in angle brackets>):

UI Element (A-Z)	Description
	<b>New.</b> Opens the Create Configuration Item Type Wizard which enables you to define a new CI type. For details, see <a href="#">"Create Configuration Item Type/Relationship/Calculated Relationship Wizard" on page 506</a> .

UI Element (A-Z)	Description
	<p><b>Delete.</b> Deletes the selected CI type or relationship. This option is only available for CI types that have no children and no instances.</p> <p><b>Note:</b></p> <ul style="list-style-type: none"> <li>When you delete a CI type or relationship, all resources dependent on that CI type or relationship are also deleted. When you click <b>Delete</b>, the Confirm Delete dialog box displays links for each type of dependent resource. Click the links to display the dependent resources. The dependent resources can include queries, views, reports, Enrichments, or Impact rules.</li> <li>Deleting a CI type that is part of the out-of-the-box Class Model may disable UCMDB's licensing mechanism. Disabling of the license mechanism will result in restricted access to UCMDB. Access to UCMDB will only be granted after the impacting Class Model changes are reverted. To troubleshoot these issues, refer to the UCMDB licensing log.</li> </ul>
	<p><b>Refresh.</b> Refreshes the data content of the hierarchical tree structure that may have been modified by other users.</p>
	<p><b>Save.</b> Saves the changes made to a CI type.</p>
	<p><b>Import From XML.</b> Enables you to import CITs from an external file.</p>
	<p><b>Export To XML.</b> Enables you to export a CIT as an XML file. Use this option to move CITs from one server to another.</p>
	<p><b>Export Class Model.</b> Enables you to export a CIT. Choose the export format. The available options are:</p> <ul style="list-style-type: none"> <li><b>PDF.</b> The table data is exported in PDF format.</li> <li><b>XLS.</b> The table data is formatted as an .xls (Excel) file that can be displayed in a spreadsheet.</li> </ul>
	<p><b>View UCMDB Class Model.</b> Opens the Class Model Reference, which contains information on all packages, CI types, and relationships in the class model.</p>
<p><b>&lt;CI Type/Relationship Box&gt;</b></p>	<p>Select one of the following options:</p> <ul style="list-style-type: none"> <li><b>CI Types.</b> Display the CI types in the CIT model.</li> <li><b>Relationships.</b> Display the relationships in the CIT model.</li> </ul>

UI Element (A-Z)	Description
	<ul style="list-style-type: none"> <li>• <b>Calculated Relationships.</b> Display the calculated relationships in the CIT model.</li> </ul>
<b>&lt;Editing Pane&gt;</b>	<p>The following tabs are available:</p> <ul style="list-style-type: none"> <li>• <b>Dependencies.</b> Displays the CI Type model in a topology map, including the CITs and the relationships between them. The name of the selected CI type or relationship appears in the border at the top of the pane. When you point to a CIT, a tooltip displays the display name of the CIT and its description.</li> <li>• <b>Details.</b> Enables you to edit the basic information about the CI type selected in the left pane. For details, see "<a href="#">Details Page</a>" on page 507.</li> <li>• <b>Attributes.</b> Enables you to edit the attributes of the selected CIT. For details, see "<a href="#">Attributes Page</a>" on page 508.</li> <li>• <b>Qualifiers.</b> Enables you to assign qualifiers to the selected CIT. For details, see "<a href="#">Qualifiers Page</a>" on page 512.</li> <li>• <b>Triplets.</b> Enables you to create a calculated relationship. For details, see "<a href="#">Triplets Page</a>" on page 514. This tab appears only for calculated relationships.</li> <li>• <b>Icon.</b> Enables you to assign an icon to the selected CIT. For details, see "<a href="#">Icon Page</a>" on page 515. This tab does not appear for relationships.</li> <li>• <b>Attached Menu.</b> Enables you to customize the shortcut menu of a CI by adding menu items and commands (for example, ping, run a program, open a URL). The customized menu is displayed when you right-click a CI instance in IT Universe Manager. For details, see "<a href="#">Attached Menu Page</a>" on page 516.</li> <li>• <b>Default Label.</b> Enables you to define attributes that appear in the CIT label. You can include more than one attribute by using the function buttons. For details, see "<a href="#">Default Label Page</a>" on page 519.</li> <li>• <b>Matching Rules.</b> Enables you to define matching rules for use in HP Universal CMDB Configuration Manager. For details, consult the Configuration Manager documentation. This tab does not appear for relationships and only appears when UCMDB is running with Configuration Manager.</li> </ul>
<b>&lt;Main Menu&gt;</b>	For details, see " <a href="#">Main Menu</a> " on page 164.
<b>&lt;Toolbar&gt;</b>	For details, see " <a href="#">Toolbar Options</a> " on page 168.
<b>CI Types Pane</b>	A hierarchical tree structure of the CI Type model containing the inheritance



UI Element (A-Z)	Description
	relationships among CITs, and displaying the number of instances of each CIT in the CMDB. All CITs included in the CI Type model are classified as either a CIT or a relationship. You can drill down and view the relationships and neighbors of the selected CIT in the topology map. You can search in the list of CITs or relationships using the Incremental Search by entering the first letter of the CIT or relationship repeatedly until you reach the required selection. You can also search for a CIT or relationship by entering its full name.

### Shortcut Menu

CI Type Manager includes the following options available by right-clicking a CI type in the CI Types pane or the Dependencies map:

UI Element (A-Z)	Description
<b>Add/Remove Relationship</b>	Opens the Add/Remove Relationship dialog box, which enables you to add or remove relationships from CITs. For details, see <a href="#">"Add/Remove Relationship Dialog Box" on page 501</a> .
<b>Delete Selected Item</b>	<p>Deletes the selected CI type. This option is only available for CI types that have no children and no instances.</p> <div data-bbox="415 1129 1369 1360" style="background-color: #f0f0f0; padding: 10px;"> <p><b>Note:</b> When you delete a CI type or relationship, all resources dependent on that CI type or relationship are also deleted. When you select <b>Delete Selected Item</b>, the Confirm Delete dialog box displays links for each type of dependent resource. Click the links to display the dependent resources. The dependent resources can include queries, views, reports, Enrichments, or Impact rules.</p> </div>
<b>Export To XML</b>	Enables you to export a CIT as an XML file. Use this option to move CITs from one server to another.
<b>New</b>	Opens the Create Configuration Item Type Wizard which enables you to define a new CI type. For details, see <a href="#">"Create Configuration Item Type/Relationship/Calculated Relationship Wizard" on the next page</a> .
<b>Show CIT Instances</b>	Opens the Show All Instances dialog box, which displays all instances of the selected CIT. For details, see <a href="#">"CI Instances Dialog Box" on page 66</a> .

## Create Configuration Item Type/Relationship/Calculated Relationship Wizard

This wizard enables you to define a new configuration item type or relationship.

<b>To access</b>	Click a CI type or relationship in the topology map or CI Types pane of the CI Type Manager and select <b>New</b> or click the <b>New</b>  button in the CI types pane.
<b>Relevant tasks</b>	<ul style="list-style-type: none"><li>• <a href="#">"How to Create a CI Type" on page 490</a></li><li>• <a href="#">"How to Create a Relationship Type" on page 492</a></li><li>• <a href="#">"How to Create a Calculated Relationship Type" on page 493</a></li></ul>
<b>Wizard map</b>	The "Create Configuration Item Type/Relationship/Calculated Relationship Wizard" contains:  <a href="#">"Details Page"</a> > <a href="#">"Attributes Page"</a> > <a href="#">"Qualifiers Page"</a> > <a href="#">"Triplets Page"</a> > <a href="#">"Icon Page"</a> > <a href="#">"Attached Menu Page"</a> > <a href="#">"Default Label Page"</a> > <a href="#">"Matching Rules Page"</a>
<b>See also</b>	<ul style="list-style-type: none"><li>• <a href="#">"CI Types Overview" on page 485</a></li><li>• <a href="#">"CI Type Attributes" on page 486</a></li><li>• <a href="#">"CI Type Relationships" on page 488</a></li></ul>

The Create Configuration Item Type wizard includes the following pages:

- ["Details Page" on the next page](#)
- ["Attributes Page" on page 508](#)
- ["Qualifiers Page" on page 512](#)
- ["Triplets Page" on page 514](#)
- ["Icon Page" on page 515](#)
- ["Attached Menu Page" on page 516](#)
- ["Default Label Page" on page 519](#)
- ["Matching Rules Page" on page 521](#)

## Details Page

This wizard page enables you to enter basic information about the new CI type you are defining.

<b>Important information</b>	For general information about the Create Configuration Item Type Wizard, see <a href="#">"Create Configuration Item Type/Relationship/Calculated Relationship Wizard"</a> on the previous page.
<b>Wizard map</b>	The <a href="#">"Create Configuration Item Type/Relationship/Calculated Relationship Wizard"</a> contains:  <a href="#">"Details Page"</a> > <a href="#">"Attributes Page"</a> > <a href="#">"Qualifiers Page"</a> > <a href="#">"Triplets Page"</a> > <a href="#">"Icon Page"</a> > <a href="#">"Attached Menu Page"</a> > <a href="#">"Default Label Page"</a> > <a href="#">"Matching Rules Page"</a>

User interface elements are described below:

<b>UI Element (A-Z)</b>	<b>Description</b>
<b>Base CI Type</b>	Select a base CIT for the CIT you are creating. The new CIT inherits the base CIT's attributes.  <b>Note:</b> This field only appears in the Create CI Type Wizard. It is not relevant when editing an existing CIT in the Details tab of CI Type Manager.
<b>Created By</b>	The user who created the new CIT.  <b>Note:</b> This field is optional.
<b>Description</b>	A description for the new CIT. The description can be up to 2,048 characters long.  <b>Note:</b> This field is optional.
<b>Display Name</b>	The name of the CIT as it appears in the HP Universal CMDB interface.  <b>Note:</b> This field is optional.
<b>Identification</b>	Every new CI defined has an identification based on its CMDB ID and global_id properties. You can set an additional identification method for instances of the selected CIT. The following options are available: <ul style="list-style-type: none"> <li>• <b>By key attributes.</b> Select attributes from the Available Attributes pane and move</li> </ul>

UI Element (A-Z)	Description
	<p>them to the Selected Attributes pane. These attributes are defined as the CIT's key attributes. CIT instances with matching values for all of the key attributes are merged into a single instance.</p> <ul style="list-style-type: none"> <li>• <b>By identification rule.</b> Click the <b>Edit</b> button to define an XML identification rule. For an example of an XML identification rule, see <i>How to Create an Identification Rule Document</i> in the <i>HP Universal CMDB Data Flow Management Guide</i>.</li> <li>• <b>Inherited from parent.</b> The CIT uses the same identification method as its parent CIT.</li> <li>• <b>No identification.</b> No additional identification method.</li> </ul> <p><b>Note:</b> For relationships, only the <b>By key attributes</b> option is available.</p>
<b>Name</b>	<p>The unique name of the new CIT. Only the following characters are permitted: a-z, A-Z, 0-9 and underscore (_). Note also:</p> <ul style="list-style-type: none"> <li>• The first character must be a-z or A-Z.</li> <li>• The name field is case sensitive, but you cannot use the same name with different cases for different CITs.</li> <li>• The maximum length is 200 characters.</li> </ul>
<b>Scope</b>	<p>Select the scope of the new CIT (the class model to which it belongs).</p>





## Attributes Page

This wizard page enables you to edit the attributes of the CI type.

<b>Important information</b>	<p>For each attribute, there are columns which display its name, display name, type, description and default value. There are also columns for each attribute qualifier. A check mark indicates that the qualifier is selected.</p> <p>Click the <b>Edit</b> button to edit attribute details and qualifiers. For CI types with instances, some qualifiers cannot be modified, as displayed in the <b>Qualifier can be modified when there are CIT instances</b> column. If a qualifier is modified for a selected attribute for a CI type with instances, the attribute of each CI instance is changed accordingly (for example, if the <b>Visible</b> attribute is selected, the CI instances become visible in IT Universe Manager).</p>
------------------------------	---

<b>Wizard map</b>	<p>The <a href="#">"Create Configuration Item Type/Relationship/Calculated Relationship Wizard"</a> contains:</p> <p><a href="#">"Details Page"</a> &gt; <b><a href="#">"Attributes Page"</a></b> &gt; <a href="#">"Qualifiers Page"</a> &gt; <a href="#">"Triplets Page"</a> &gt; <a href="#">"Icon Page"</a> &gt; <a href="#">"Attached Menu Page"</a> &gt; <a href="#">"Default Label Page"</a> &gt; <a href="#">"Matching Rules Page"</a></p>
-------------------	---

User interface elements are described below (unlabeled elements are shown in angle brackets):

<b>UI Element (A-Z)</b>	<b>Description</b>	<b>Qualifier can be modified when there are CIT instances</b>
	<b>Add.</b> Enables you to define a new attribute. For details, see <a href="#">"Add/Edit Attribute Dialog Box"</a> on page 497.	N/A
	<p><b>Edit.</b> Opens the Edit Attribute dialog box. For details, see <a href="#">"Add/Edit Attribute Dialog Box"</a> on page 497.</p> <p><b>Note:</b> If you modify an attribute belonging to a CIT's parent, the text turns light blue. If you modify an attribute belonging to the CIT itself, the text remains dark blue.</p>	N/A
	<b>Delete.</b> Deletes the selected attribute. This option is only active for newly defined attributes.	N/A
	<b>Reset.</b> Resets the attribute settings after editing a pre-existing attribute.	N/A
	<b>Select Columns.</b> Enables you to select the columns to appear using the Select Columns dialog box. For details, see <a href="#">"Select Columns Dialog Box"</a> on page 571.	N/A
<b>&lt;Attributes&gt;</b>	Displays all attributes associated with the new CIT. Attributes appearing in black are ones that the new CIT inherits from the base CIT. Attributes appearing in dark blue are ones that are private to this CIT and its descendants. Attributes appearing in light blue are inherited ones that have been modified for the new CIT.	N/A
<b>Asset Data</b>	<p>Indicates whether the attribute value is displayed in the Asset Report. For details see <a href="#">"Asset Report"</a> on page 371.</p> <p><b>Note:</b> When this qualifier is selected for a given attribute, the attribute appears as a visible column in</p>	Yes

<b>UI Element (A-Z)</b>	<b>Description</b>	<b>Qualifier can be modified when there are CIT instances</b>
	<p>the CI Instances dialog box. For details, see "<a href="#">CI Instances Dialog Box</a>" on page 66.</p>	
<b>CMS Browser Editable</b>	Indicates whether this attribute is editable in the UCMDB Browser.	Yes
<b>CMS Browser Searchable</b>	Indicates whether this attribute is searchable in the UCMDB Browser.	Yes
<b>CMS Browser Visible</b>	Indicates whether this attribute is visible in the UCMDB Browser.	Yes
<b>Comparable</b>	<p>Indicates whether this attribute is to be used for comparing compound CIs. For details, see "<a href="#">Compare CIs Report</a>" on page 390. The changes in the value of such an attribute are saved in the History.</p> <p><b>Note:</b> When this qualifier is selected for a given attribute, the attribute appears as a visible column in the CI Instances dialog box. For details, see "<a href="#">CI Instances Dialog Box</a>" on page 66.</p>	Yes
<b>Default Value</b>	The default value for the attribute. This value appears when the new CIT is defined and there is no runtime value for the attribute.	N/A
<b>Description</b>	A description of the attribute.	N/A
<b>Discovery Auto Trim</b>	Indicates whether the results sent from the Probe are trimmed.	Yes
<b>Discovery Auto Truncate</b>	Indicates whether the auto-truncate feature for attributes of type STRING is enabled.	Yes
<b>Display Name</b>	The attribute name that appears in the HP Universal CMDB interface.	N/A
<b>Editable</b>	<p>Indicates whether the attribute can be edited.</p> <p>Only attributes that are marked as <b>Editable</b> (or ones that have values) are displayed in the Properties tab in IT</p>	Yes

<b>UI Element (A-Z)</b>	<b>Description</b>	<b>Qualifier can be modified when there are CIT instances</b>
	Universe Manager.	
<b>Index</b>	<p>Indicates whether the attribute has been defined as an index attribute, which enables you to accelerate the attribute retrieval performance.</p> <p>This option is recommended for attributes that are used frequently in search conditions. For example, IP address is usually an index attribute of a node.</p>	Yes
<b>Key</b>	<p>Indicates whether the attribute is defined as a key attribute.</p> <p><b>Note:</b> This column is only relevant when <b>By key attributes</b> is selected as the identification method.</p>	Yes
<b>Lower Case</b>	Indicates whether to keep the attribute value in lower case.	Yes
<b>Managed</b>	<p>This designation is only relevant for users of HP Universal CMDB Configuration Manager.</p> <p><b>Note:</b> When this qualifier is selected for a given attribute, the attribute appears as a visible column in the CI Instances dialog box. For details, see "<a href="#">CI Instances Dialog Box</a>" on page 66.</p>	Yes
<b>Name</b>	The actual name of the attribute (compare to Display Name). The name must be in English.	N/A
<b>Not Tracked for History</b>	When this qualifier is selected for a given attribute, the attribute is not monitored by History.	Yes
<b>Required</b>	Indicates whether this attribute is defined as a required one, whose value is required for the creation of the CIT.	Only if the attribute in the instances is not empty
<b>Static</b>	Indicates whether this attribute is defined as static.	No
<b>Type</b>	The type of the attribute.	N/A
<b>UDM Scope</b>	Indicates whether the attribute is included in the UDM class model.	No
<b>Unique</b>	Indicates whether this attribute is defined as unique, for	No





UI Element (A-Z)	Description	Qualifier can be modified when there are CIT instances
	which different instances of this CI type must have unique values.	
<b>Upper Case</b>	Indicates whether to keep the attribute value in upper case.	Yes
<b>Visible</b>	Indicates whether this attribute is displayed in the Properties tab in IT Universe Manager.	Yes

## Qualifiers Page

This wizard page enables you to assign qualifiers to a CI type definition.

<b>Important information</b>	Qualifiers enable you to define added attribute definitions to the CIT. In the <b>Qualifiers</b> list, select the required qualifiers using the <b>Add</b> buttons to move your selections to the <b>Configuration Item Type Qualifiers</b> list. You can make multiple selections by holding the <b>CTRL</b> key.
<b>Wizard map</b>	The " <a href="#">Create Configuration Item Type/Relationship/Calculated Relationship Wizard</a> " contains:  <a href="#">"Details Page"</a> > <a href="#">"Attributes Page"</a> > <a href="#">"Qualifiers Page"</a> > <a href="#">"Triplets Page"</a> > <a href="#">"Icon Page"</a> > <a href="#">"Attached Menu Page"</a> > <a href="#">"Default Label Page"</a> > <a href="#">"Matching Rules Page"</a>

User interface elements are described below (unlabeled elements are shown in angle brackets>):

UI Element (A-Z)	Description
	Moves all qualifiers to the <b>Configuration Item Type Qualifiers</b> list.
	Adds the selected qualifier to the <b>Configuration Item Type Qualifiers</b> list. Select multiple qualifiers by holding the <b>CTRL</b> key.
	Removes the selected qualifier from the <b>Configuration Item Type Qualifiers</b> list.
	Removes all qualifiers from the <b>Configuration Item Type Qualifiers</b> list.
	To define a new, custom qualifier, enter the qualifier name in the text box and click <b>Insert</b> . The qualifier appears in the <b>Configuration Item Type Qualifiers</b> list.
<b>&lt;Configuration</b>	The list of qualifiers that define attributes of the new CIT. For example, you can use



UI Element (A-Z)	Description
<b>Item Type Qualifiers&gt;</b>	a qualifier to define a CIT as abstract, which means that you cannot create instances from it.
< <b>Qualifiers</b> >	The list of available qualifier options.
<b>ABSTRACT_CLASS</b>	You cannot create instances of this CIT.
<b>BLE_LINK_CLASS</b>	Relevant for HP Business Service Management only.
<b>CONTAINER</b>	This qualifier is assigned to relationships that signify a containment relationship, such as Membership, Composition, Containment.
<b>HANDLER</b>	Relevant for HP Business Service Management only.
<b>HIDDEN_CLASS</b>	Instances of this CIT do not appear anywhere in the application.
<b>ITU_HIDDEN_CLASS</b>	Instances of this CIT do not appear in the topology map application.
<b>MAJOR_APP</b>	CI types that are assigned this qualifier appear in the Application Breakdown custom report. For details, see <a href="#">"Application Breakdown Report" on page 367</a> .
<b>MODELING_ENABLED</b>	<p>Enables a CIT to act as a model in the Modeling Studio. For details, see <a href="#">"Business CI Models" on page 262</a>.</p> <p><b>Note:</b> This qualifier can only be selected for CI types that are descendants of the CI type <b>Configuration Item</b>.</p>
<b>NETWORK_DEVICES</b>	A qualifier common to all the CI types that represent a network device. It can be used for TQL queries related to network devices and serves as a replacement for CI types in a query.
<b>PM_SUSPECT</b>	Relevant for HP Business Service Management only.
<b>READ_ONLY_CLASS</b>	This CIT cannot be edited.
<b>RECURSIVE_DELETE</b>	<p>Relevant for relationships. When the CI at one end of a relationship is deleted, the system checks the CI at the other end of the relationship. If it is not related to any other CIs, it is also deleted.</p> <p><b>Note:</b> This qualifier appears only in the qualifier list in Modeling Studio.</p>

UI Element (A-Z)	Description
<b>SERVICE_MODEL</b>	Relevant for the UCMDB Browser. Only CI Types that have this qualifier are available in the UCMDB Browser as a service, and may be used to create Service Models in the UCMDB Browser.
<b>STRONG_CONTAINMENT</b>	Relevant for relationships. Indicates that the root_container attribute of end2 is assigned the ID of end1.

## Triplets Page





This wizard page enables you to create a calculated relationship. Each row on the Triplets page represents one of the allowed steps in the path leading from the source CI to the target CI in the topology map.

**Note:** This step of the wizard is only relevant for calculated relationships.

<b>Important information</b>	<ul style="list-style-type: none"> <li>This page is displayed if you select <b>Calculated Relationships</b> in the drop-down box in the CI Types pane.</li> <li>For details about calculated relationships, see <a href="#">"Using Calculated Relationships" on page 99</a>.</li> <li>For general information about the Create Configuration Item Type Wizard, see <a href="#">"Create Configuration Item Type/Relationship/Calculated Relationship Wizard" on page 506</a>.</li> </ul>
<b>Wizard map</b>	<p>The <a href="#">"Create Configuration Item Type/Relationship/Calculated Relationship Wizard"</a> contains:</p> <p><a href="#">"Details Page"</a> &gt; <a href="#">"Attributes Page"</a> &gt; <a href="#">"Qualifiers Page"</a> &gt; <b>"Triplets Page"</b> &gt; <a href="#">"Icon Page"</a> &gt; <a href="#">"Attached Menu Page"</a> &gt; <a href="#">"Default Label Page"</a> &gt; <a href="#">"Matching Rules Page"</a></p>
<b>See also</b>	<a href="#">"Using Calculated Relationships" on page 99</a>

User interface elements are described below:

UI Element (A-Z)	Description
	<b>Add.</b> Enables you to define the allowed steps in a path in the topology graph leading from the source CI to the target CI in the calculated relationship. Opens the Add Triplet dialog box. For details, see <a href="#">"Add Triplet Dialog Box" on page 63</a> .

UI Element (A-Z)	Description
	<b>Edit.</b> Enables you to edit the triplet. Opens the Edit Triplet dialog box. For details, see <a href="#">"Add Triplet Dialog Box"</a> on page 63.
	<b>Delete.</b> Deletes a selected triplet.
<b>Relationship</b>	The required relationship connecting the two query nodes.
<b>Relationship Direction</b>	The source and target of a relationship. <ul style="list-style-type: none"> <li> The direction is from source to target.</li> <li> The direction is from target to source.</li> </ul>
<b>Source</b>	The required source query node.
<b>Target</b>	The required target query node.

## Icon Page

This wizard page enables you to select an icon to assign to the new CI Type.

**Note:** This step of the wizard is not relevant for relationships.

<b>Important information</b>	Each CIT is displayed with a default icon. However, you can attach different icons to the same CIT when certain conditions apply. For example, you can associate different icons with the same CIT when one of its attribute values changes.
<b>Wizard map</b>	The <a href="#">"Create Configuration Item Type/Relationship/Calculated Relationship Wizard"</a> contains:  <a href="#">"Details Page"</a> > <a href="#">"Attributes Page"</a> > <a href="#">"Qualifiers Page"</a> > <a href="#">"Triplets Page"</a> > <b>"Icon Page"</b> > <a href="#">"Attached Menu Page"</a> > <a href="#">"Default Label Page"</a> > <a href="#">"Matching Rules Page"</a>

User interface elements are described below:

UI Element (A-Z)	Description
	<p><b>Add Icon Function.</b> Adds a row.</p> <p><b>Note:</b> Only active if <b>Change the Configuration Item Type icon according to its attribute value</b> is selected.</p>





UI Element (A-Z)	Description
	<p><b>Remove Icon Function.</b> Removes the selected row.</p> <p><b>Note:</b> Only active if <b>Change the Configuration Item Type icon according to its attribute value</b> is selected.</p>
<b>Attributes</b>	Select an attribute to determine the icon assigned to the CIT.
<b>Change the Configuration Item Type icon according to its attribute value</b>	<p>Enables you to assign an icon for each attribute value. For example, you could define two values for the <i>City</i> attribute: if <i>City</i>=London, one icon is displayed. If <i>City</i>=Beijing, another icon is displayed.</p> <p><b>Note:</b> If you change the icon of a CIT that appears in an existing view, the CIT's icon is not updated in the view.</p>
<b>Configuration Item Type Main Icon</b>	Select the group to which the CIT belongs.
<b>Icon</b>	Select an icon to associate with the value you entered in the Value column.
<b>Value</b>	Enter a value corresponding to the attribute you selected. You can add a new line for each value you enter.

## Attached Menu Page

This wizard page enables you to customize the shortcut menu of a CI by adding menu items and commands (for example, ping, run a program, open a URL). The customized menu is displayed when you right-click a CI instance in IT Universe Manager.

<b>Important information</b>	<p>If a CIT does not have a method defined specifically for it, the CIT inherits all the menus from its parent CIT or the nearest ancestor that does have a method defined for it.</p> <p>If you create or modify a menu, the change occurs only in the specific CIT that is being edited.</p>
<b>Wizard map</b>	<p>The <a href="#">"Create Configuration Item Type/Relationship/Calculated Relationship Wizard"</a> contains:</p> <p><a href="#">"Details Page"</a> &gt; <a href="#">"Attributes Page"</a> &gt; <a href="#">"Qualifiers Page"</a> &gt; <a href="#">"Triplets Page"</a> &gt; <a href="#">"Icon Page"</a> &gt; <a href="#">"Attached Menu Page"</a> &gt; <a href="#">"Default Label Page"</a> &gt; <a href="#">"Matching Rules Page"</a></p>

User interface elements are described below:

UI Element (A-Z)	Description
	Select a menu item from the tree and click the button. A new entry appears under the selected item.
	Click to remove a menu item.
	Click to move a selected menu item up in the menu.
	Click to move a selected menu item down in the menu.
<Tree>	Hierarchical tree containing the default menu items.  <div style="background-color: #f0f0f0; padding: 5px;"><b>Caution:</b> It is not recommended to edit the definitions of the default menu items.</div>
Command	To connect to a specific location on the World Wide Web, select URL, and enter the exact Internet address, for example, <code>http://www.hp.com/go/software</code> . (Available only if you select the URL command type option.)  <div style="background-color: #f0f0f0; padding: 5px;"><b>Note:</b> If you use a variable in the Command field, use the format <code>command name %1</code> and define the CIT attributes as described in <a href="#">"Parameters" on the next page</a>. The parameter values replace %1 according to their order in the list. For example, %1 is replaced by the first parameter in the list, %2 is replaced by the second parameter in the list, and so on.</div>
Description	Enter a description for the method. (This is for internal use only and does not appear in the menu.)
Existing Method	Select to choose a command from a list of defined methods inherited from the IT Universe CIT and all its ancestors.
Icon	Select the icon to appear next to the menu option in the shortcut menu.  <div style="background-color: #f0f0f0; padding: 5px;"><b>Note:</b> This field is optional.</div>
Menu Item Name	Enter a name for the new menu item as it should appear in the menu.
Method	Enables you to add a command to the menu.  <div style="background-color: #f0f0f0; padding: 5px;"><b>Note:</b> To create a method and not override the existing method, it is recommended to create a new menu item and place the new method there.</div>

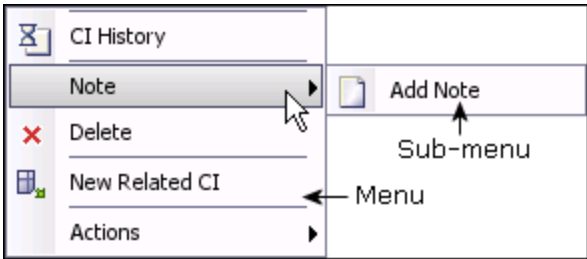
UI Element (A-Z)	Description
<b>Method Name</b>	Enter a name for the command.
<b>New Method</b>	Select to add an action (for example, ping) to the menu item.
<b>Parameters</b>	<p>To add attributes to the command or URL, click the <b>Add Parameter</b> button and select the attribute from the list.</p> <p>To delete an existing entry, select it and click the <b>Remove Parameter</b> button.</p> <p><b>Note:</b> Parameters are not relevant when Inner Process is selected.</p>
<b>Require user confirmation</b>	Select the check box for users to confirm access to a menu item before the item is displayed.
<b>Separator</b>	<p>To place a separator between two menu items:</p> <p>Click <b>OK</b> to place a separator underneath the selected menu option.</p>
<b>Shortcut</b>	<p>Press any key combination to create a shortcut for the menu item, for example, <b>CTRL+h</b>.</p> <p><b>Note:</b> This field is optional.</p>
<b>Sub-Menu</b>	<p>Select to create a sub-menu under the selected menu option.</p>  <p>The screenshot shows a menu with items: CI History, Note, Delete, New Related CI, and Actions. The 'Note' item is selected and expanded to show a sub-menu with 'Add Note' and 'Sub-menu' items. Arrows indicate the relationship between the main menu item and its sub-menu.</p>
<b>Type</b>	<p>Choose a command type:</p> <ul style="list-style-type: none"> <li>• <b>URL.</b> Opens a web page to the specified URL. Enter the URL of a Web page for the command to open in the URL box.</li> <li>• <b>Inner Process.</b> Triggers an internal HP Universal CMDB action. Select an action from the drop-down list of actions.</li> <li>• <b>Execute.</b> Triggers an executable action. Enter an executable command in the <b>Executable</b> box.</li> </ul>

UI Element (A-Z)	Description
	<p><b>Note:</b> In the <b>Executable</b> box, enter only the name of the executable file (for example, <code>notepad.exe</code>). Do not enter a path to the executable file. A path cannot execute a program.</p>



**Note:** After making changes to a CI type in an older version of UCMDDB (for example, UCMDDB version 9.05), when upgrading UCMDDB to the latest version, some new functionality may be missing from the shortcut menu for CIs of that type or its descendants in IT Universe Manager. In that case, edit the attached menu for that CI type and add the missing functionality.







## Default Label Page

This wizard page enables you to define attributes that appear in the CI type label. You can include more than one attribute by using the function buttons.

<p><b>Important information</b></p>	<p>You build a label by selecting attributes in the CI Type Attributes pane and adding them to the Format pane, using the operators in the Format pane to connect them.</p> <p>The label appears as the title under a CI of the new CI Type. The label definition can be customized to include different attribute values. For example, if the function label of the node CIT is composed of <code>hostname</code> and <code>network</code>, the displayed label is: <code>server1 10.0.65.0</code>.</p> <p>Labels can also be created using regular expressions.</p>
<p><b>Wizard map</b></p>	<p>The <a href="#">"Create Configuration Item Type/Relationship/Calculated Relationship Wizard"</a> contains:</p> <p><a href="#">"Details Page"</a> &gt; <a href="#">"Attributes Page"</a> &gt; <a href="#">"Qualifiers Page"</a> &gt; <a href="#">"Triplets Page"</a> &gt; <a href="#">"Icon Page"</a> &gt; <a href="#">"Attached Menu Page"</a> &gt; <b><a href="#">"Default Label Page"</a></b> &gt; <a href="#">"Matching Rules Page"</a> on page 521</p>

User interface elements are described below:

UI Element (A-Z)	Description
	<p><b>Add selected attribute.</b> Adds the selected attribute to the Format pane.</p>
	<p><b>Parentheses.</b> Adds parentheses to the formatted text (use in conjunction with the other</p>

UI Element (A-Z)	Description
	functions).
	<b>And.</b> Places an <b>AND</b> operator between two attributes in the formatted text. For example, <b>network_netaddr&amp;network_domain</b> displays the network address and the domain of a query node.
	<b>Or.</b> Places an <b>OR</b> operator between two attributes in the formatted text.
	<p><b>Regular Expression.</b> Adds a regular expression (using regular expression syntax) to the label definition. The structure of the entry is <b>(v1, v2, v3)</b>, where <b>v1</b> represents the selected attribute, <b>v2</b> represents the regular expression itself (which divides the value into groups), and <b>v3</b> represents the number of the selected group.</p> <p>For example, if the selected attribute is a name, consisting of a first name, a space, and a surname, the regular expression would be <code>(name, (\S*)(\S*)(\S*), 3)</code>, which indicates that the surname can be used for the name attribute in the default label.</p> <p>For examples of how to use regular expression syntax, see <a href="#">"Regular Expression Examples" on page 574</a>.</p>
	<b>Undo.</b> Reverses the last change you made.
	<b>Redo.</b> Repeats the last action you took.
	<b>Clear.</b> Clears the Format pane.
	<b>Restore Default.</b> Restores the default settings.
<b>CI Type Attributes</b>	Displays the available options of attributes to be included in the CIT label.
<b>CI Type Label Definition Format</b>	<p>Displays the attributes that you select to appear in the CIT label.</p> <p>For example, to label a node by its host name and operating system, choose the <b>host_hostname</b> and <b>host_os</b> attributes. The CIT label is <code>host1 UNIX</code>.</p> <p>You can define conditions using <b>AND</b> and <b>OR</b> combinations.</p> <div style="background-color: #f0f0f0; padding: 10px; margin-top: 10px;"> <p><b>Note:</b> To delete an attribute from the <b>Format</b> pane, highlight it and press the <b>Delete</b> key.</p> </div>







## Matching Rules Page

This wizard page enables you to define matching rules for comparable attributes for use in HP Universal CMDB Configuration Manager.

<p><b>Important information</b></p>	<p>This page is only relevant when Configuration Manager is installed. For details on matching rules, refer to the Configuration Manager documentation.</p> <div style="background-color: #f0f0f0; padding: 10px; margin-top: 10px;"> <p><b>Note:</b> You can activate the Matching Rules page manually by setting the <b>Enable Configuration Manager Matching Rules</b> setting to <b>true</b> in the Infrastructure Settings Manager.</p> </div>
<p><b>Wizard map</b></p>	<p>The "<a href="#">Create Configuration Item Type/Relationship/Calculated Relationship Wizard</a>" contains:</p> <p><a href="#">"Details Page"</a> &gt; <a href="#">"Attributes Page"</a> &gt; <a href="#">"Qualifiers Page"</a> &gt; <a href="#">"Triplets Page"</a> &gt; <a href="#">"Icon Page"</a> &gt; <a href="#">"Attached Menu Page"</a> &gt; <a href="#">"Default Label Page"</a> &gt; <b>"Matching Rules Page"</b></p>

User interface elements are described below:

<p><b>UI Element (A-Z)</b></p>	<p><b>Description</b></p>
	<p>Moves the selected comparable attributes to the Matching Rule Priorities pane or the Required Matching Attributes pane. Select multiple attributes by holding the <b>CTRL</b> key.</p>
	<p>Removes the selected attribute from the Matching Rule Priorities pane or the Required Matching Attributes pane.</p>
	<p>Moves all attributes to the Matching Rule Priorities pane or the Required Matching Attributes pane.</p>
	<p>Removes all attributes from the Matching Rule Priorities pane or the Required Matching Attributes pane.</p>
	<p>Sets the order of the matching rules using the up and down buttons.</p>
<p><b>Comparable Attributes</b></p>	<p>A list of all the attributes of the selected CI type with the <b>comparable</b> qualifier selected.</p>
<p><b>Matching Rule Priorities</b></p>	<p>The attributes selected are used by Configuration Manager, according to the priority defined, to determine if the matching rule is satisfied.</p>

UI Element (A-Z)	Description
<b>Required Matching Attributes</b>	The values of the selected attributes of component CIs must match to satisfy the Configuration Manager matching rule, when comparing between composite CIs.  Wildcards cannot be used when specifying a required matching attribute. If an exact match is not found, component CIs are not compared.

## Create/Update List/Enumeration Definition Dialog Box

This dialog box enables you to define a new List or Enumeration definition. The List or Enumeration definition you have created appears in the System Type Manager dialog box, where you can edit it if required (for details, see ["System Type Manager Dialog Box" on page 527](#)).

<b>To access</b>	Click the <b>Add</b>  button in the System Type Manager dialog box.
<b>Important information</b>	You can access the Create/Update Enumeration Definition dialog box from the State Manager as well. For details, see State Manager in the <i>HP Universal CMDB Administration Guide</i> .
<b>Relevant tasks</b>	<ul style="list-style-type: none"> <li>• <a href="#">"How to Create List and Enumeration Definitions" on page 494</a></li> <li>• <a href="#">"How to Create an Enumeration Definition – Workflow" on page 494</a></li> </ul>
<b>See also</b>	<ul style="list-style-type: none"> <li>• <a href="#">"System Type Manager" on page 489</a></li> <li>• <a href="#">"System Type Manager Dialog Box" on page 527</a></li> </ul>

User interface elements are described below:



UI Element (A-Z)	Description
<b>Display Name</b>	Enter the name you want to appear in the list of System Type Definitions. If you leave this field empty, the entry in the Name field is used.
<b>Enumeration</b>	Enables you to create a predefined list of values, as well as assign each value a color. For details, see <a href="#">"Enumeration Definition Area" on the next page</a> .
<b>List</b>	Enables you to create a predefined list of values. For details, see <a href="#">"List Definition Area" on the next page</a> .
<b>Name</b>	Enter a unique name for the definition.

### List Definition Area

This area enables you to create a predefined list of values.

<b>To access</b>	Select <b>List</b> in the Create List/Enumeration Definition dialog box.
<b>Important information</b>	For example, a <code>Location</code> attribute might be defined by a location list containing the following values: <ul style="list-style-type: none"> <li>• New York</li> <li>• Boston</li> <li>• Baltimore</li> </ul>

The following elements are included (unlabeled elements are shown in angle brackets>):



<b>UI Element (A-Z)</b>	<b>Description</b>
	<b>Add.</b> Adds a List definition. Double-click inside the row and either select a date from the calendar that appears (if you chose the type <b>Date</b> ) or type the required value.
	<b>Remove.</b> Deletes the selected List definition.
	<b>Sort.</b> Sorts the list in alphabetical order.
<b>Type</b>	Choose one of following field types: <ul style="list-style-type: none"> <li>• Date</li> <li>• Double</li> <li>• Integer</li> <li>• Long</li> <li>• String</li> </ul>

### Enumeration Definition Area

This area enables you to create a list from a predefined list of values (similar to **List**), with capabilities such as assigning a color for every value.

<b>To access</b>	Select <b>Enumeration</b> in the Create List/Enumeration Definition dialog box.
<b>Important information</b>	<p>Enumerations are designed to be used as severity value lists by states. You can use Enumerations for lists that require key values.</p> <div style="background-color: #f0f0f0; padding: 10px; border: 1px solid #ccc;"> <p><b>Note:</b></p> <ul style="list-style-type: none"> <li>• If an existing enumeration definition is designated as a default value for a CIT attribute, you cannot change its value.</li> <li>• If you change the value of an existing enumeration definition, all CI instances of that CIT that include attributes with the selected value, are reset to the default value for that attribute.</li> </ul> </div>
<b>See also</b>	<a href="#">"How to Create an Enumeration Definition – Workflow" on page 494</a>

User interface elements are described below:



<b>UI Element (A-Z)</b>	<b>Description</b>
	<b>Add.</b> Adds an Enumeration definition.
	<b>Remove.</b> Deletes the selected Enumeration definition.
<b>Color</b>	<p>Select a color that indicates the severity level.</p> <div style="background-color: #f0f0f0; padding: 10px; border: 1px solid #ccc;"> <p><b>Note:</b> Gray is only enabled when you create an Enumeration of the type Admin.</p> </div>
<b>Key</b>	<p>Type a number to create an enumeration that describes a severity list for a category.</p> <p>Assign key values according to the following rules:</p> <ul style="list-style-type: none"> <li>• The list of key values must always begin with zero (0). (Zero represents the Normal state.) Otherwise, it does not appear in the State Manager (for details, see State Manager in the <i>HP Universal CMDB Administration Guide</i>).</li> <li>• The list must always be numbered consecutively.</li> </ul> <p>For an example of an Enumeration definition, see <a href="#">"How to Create an Enumeration Definition – Workflow" on page 494</a>.</p>
<b>Value</b>	Type a value, either a string or a number, for example, Red or my value. The value appears in the tooltip for the CI in IT Universe Manager.

## Export Selected CITs to Excel Dialog Box

This dialog box enables you export selected CI types to an Excel report.

<b>To access</b>	In the CI Type Manager, click the <b>Export Class Model</b>  button and select <b>Export Selected CITs to Excel</b> .
<b>Important information</b>	<p>You can select a CIT and a relationship to serve as the root CI type and root relationship for the report. If you do not select a CIT or relationship, the default values are used. The root CIT and root relationship are independent of each other.</p> <p>The report displays the root CIT and all its descendant CITs. The report contains the following pages:</p> <ul style="list-style-type: none"> <li>• <b>CIT Hierarchy.</b> Displays the CITs under the root CIT in tree format with links to their attributes.</li> <li>• <b>Relationship Hierarchy.</b> Displays the relationships under the root relationship in tree format with links to their attributes.</li> <li>• <b>CIT Attributes.</b> Displays the name, type, description and display level for the CIT attributes of each CIT under the root CIT.</li> <li>• <b>Relationship Attributes.</b> Displays the name, type, description and display level for the relationship attributes of each relationship under the root relationship.</li> <li>• <b>Valid Relationships.</b> Displays all the valid relationships for each CIT under the root CIT.</li> <li>• <b>Enumerations.</b> Displays all the enumeration definitions from the System Type Manager. (Not dependent on the root CIT or root relationship.)</li> <li>• <b>Lists.</b> Displays all the list definitions from the System Type Manager. (Not dependent on the root CIT or root relationship.)</li> </ul> <p>You can select the pages you want to display in the report.</p>
<b>See also</b>	<ul style="list-style-type: none"> <li>• <a href="#">"CI Types Overview" on page 485</a></li> <li>• <a href="#">"View Descriptions for CI Types and Relationships" on page 496</a></li> <li>• <a href="#">"Universal Data Model (UDM) Overview" on page 563</a></li> </ul>

User interface elements are described below (unlabeled elements are shown in angle brackets>):

UI Element (A-Z)	Description
<b>Root CI Type</b>	Click the ellipsis  button to select a CIT to serve as the root CI type. If you do not select a CIT, the default root CI type used . To change the default value, edit the <b>Object root</b> setting in Infrastructure Settings Manager.
<b>Root Relationship</b>	Click the ellipsis  button to select a relationship to serve as the root relationship. If you do not select a relationship, the default root relationship used. To change the default value, edit the <b>Link root</b> setting in Infrastructure Settings Manager.
<b>Select pages to display</b>	Select the pages to display in the report (select the check boxes for all the required pages). The following options are available: <ul style="list-style-type: none"> <li>• <b>CIT Worksheets.</b> Includes the CIT Hierarchy and the CIT Attributes worksheets.</li> <li>• <b>Relationship Worksheets.</b> Includes the Relationship Hierarchy and Relationship Attributes worksheets.</li> <li>• <b>Valid Relationships Worksheet.</b> Includes the Valid Relationships worksheet.</li> <li>• <b>Type Definition Worksheets.</b> Includes the Enumerations and Lists worksheets.</li> </ul>



## Export Selected CITs to PDF Dialog Box

This dialog box enables you export selected CI types to a PDF report.

<b>To access</b>	In the CI Type Manager, click the <b>Export Class Model</b>  button and select <b>Export Selected CITs to PDF</b> .
<b>Important information</b>	The output of this dialog box is the UCMDB CI Types and Relationships Information PDF, describing the Universal Data Model.
<b>See also</b>	<ul style="list-style-type: none"> <li>• <a href="#">"CI Types Overview" on page 485</a></li> <li>• <a href="#">"View Descriptions for CI Types and Relationships" on page 496</a></li> <li>• <a href="#">"Universal Data Model (UDM) Overview" on page 563</a></li> </ul>

User interface elements are described below (unlabeled elements are shown in angle brackets>):

UI Element (A-Z)	Description
<b>All Data</b>	Select to display all the information on the selected CITs.



UI Element (A-Z)	Description
<b>Changes Only</b>	Select to display only the changes in the selected CITs from the previous data model.
<b>CITs</b>	Click the ellipsis  button to select CITs to export.
<b>Filter attributes by qualifiers</b>	Select to filter the attributes in the report by qualifiers. Enter the required qualifiers in the box. The report displays only the attributes with the selected qualifiers.
<b>Relationships</b>	Click the ellipsis  button to select relationships to export.
<b>Show Properties</b>	Select the scope of the selected CITs and relationships: <ul style="list-style-type: none"> <li>• <b>UDM.</b> Includes CITs and relationships from the UDM.</li> <li>• <b>CMS.</b> Includes only CITs and relationships used in the CMS</li> </ul>
<b>Show Qualifiers</b>	Select to include qualifier information in the exported report.
<b>Show Relationships</b>	Select to include relationship information in the exported report.
<b>Show Valid Links</b>	Select to include valid link information in the exported report. The valid link section displays all the valid relationships for the selected CITs.

## System Type Manager Dialog Box

This dialog box enables you to display the attribute types you defined in the Create List/Enumeration Definition dialog box.

<b>To access</b>	In the CI Type Manager, click the <b>CI Types</b> menu and select <b>System Type Manager</b> .
<b>Relevant tasks</b>	<ul style="list-style-type: none"> <li>• <a href="#">"How to Create List and Enumeration Definitions" on page 494</a></li> <li>• <a href="#">"How to Create an Enumeration Definition – Workflow" on page 494</a></li> </ul>
<b>See also</b>	<ul style="list-style-type: none"> <li>• <a href="#">"CI Types Overview" on page 485</a></li> <li>• <a href="#">"System Type Manager" on page 489</a></li> </ul>

User interface elements are described below (unlabeled elements are shown in angle brackets>):

UI Element (A-Z)	Description
	<p><b>Add.</b> Enables you to create a predefined list whose values define an attribute type. You can create a definition for the following attribute types:</p> <ul style="list-style-type: none"> <li>• List definition.</li> <li>• Enumeration definition.</li> </ul> <p>For a description of these attribute types, see <a href="#">"Create/Update List/Enumeration Definition Dialog Box" on page 522.</a></p>
	<p><b>Edit.</b> Enables you to edit an existing definition. For details, see <a href="#">"Create/Update List/Enumeration Definition Dialog Box" on page 522.</a></p>
	<p><b>Delete.</b> Deletes an existing definition. Select the system type definition you want to delete and click the <b>Delete</b> button.</p>
<p><b>&lt;System Type Definitions&gt;</b></p>	<p>The list of Enumeration and List definitions created in the System Type Manager.</p>



# Chapter 12: Enrichment Manager

This chapter includes:

Enrichment Manager Overview .....	529
How to Define an Enrichment Rule – Scenario .....	531
How to Add Enrichment Query Nodes and Relationships to an Enrichment TQL Query .....	536
How to Define a Tenant Association Rule .....	537
Enrichment Manager User Interface .....	539

## Enrichment Manager Overview

Enrichment rules can be used for several purposes:

- Adding new CIs and relationships to the CMDB.
- Deleting specific CI instances from the CMDB.
- Updating the attribute values of specific CI instances in the CMDB.

Enrichment query nodes and relationships differ from other query nodes and relationships in that they are conceptual deductions that represent real relationships and CIs that cannot be discovered automatically by the discovery process.

Enrichment query nodes and relationships are created as part of a TQL query, whose other TQL query nodes are regular ones, meaning TQL query nodes that already exist in the CMDB. For more information about TQL queries, see ["Topology Query Language" on page 14](#).

The following example displays a regular query node of type **Node** linked to a **Websphere AS** Enrichment query node by an Enrichment **Composition** relationship.

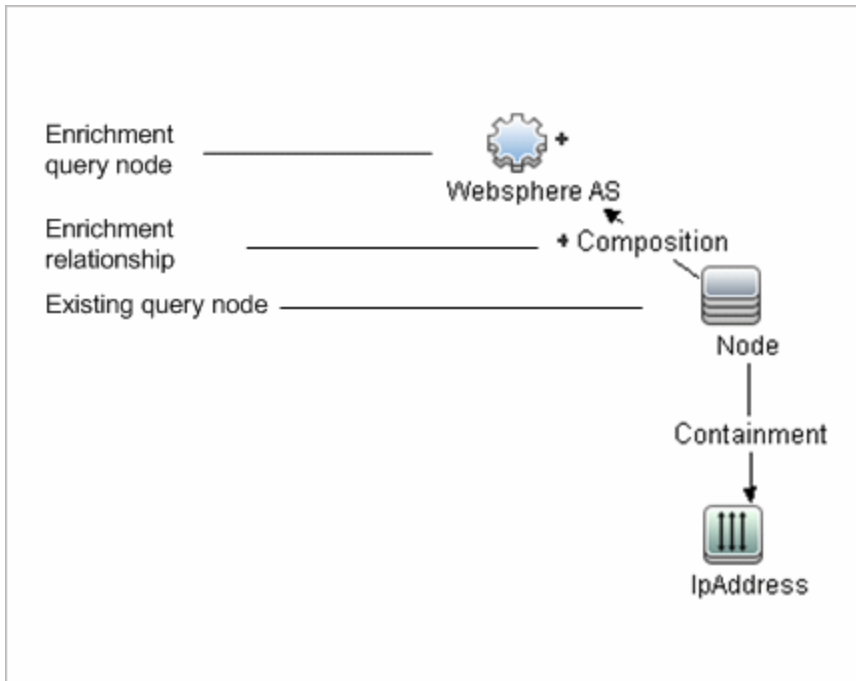

By placing an Enrichment query node within a TQL query context, the query receives data from its attributes, and uses it to insert new information into the CMDB.

When you create Enrichment rules, the following results can occur:

- **The CMDB is enlarged.** Add Enrichment query nodes and relationships that are currently not included in the CMDB.

The following Enrichment rule example displays a regular **Windows** query node (that already exists in the CMDB) connected to a **Log File** Enrichment query node by an Enrichment **Composition** relationship.

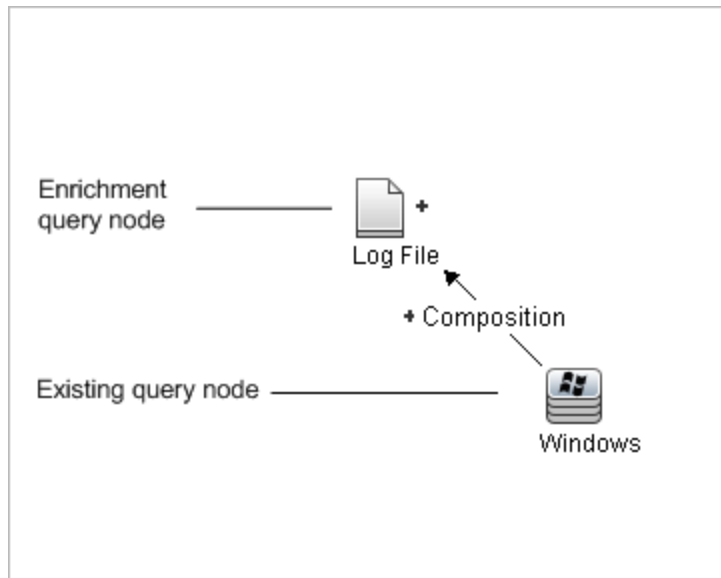

This Enrichment rule states that for every **Windows** CI instance that is found in the CMDB, a new **Log File** CI instance is created, and linked to the **Windows** CI with a **Composition** relationship.

- **Specific CI instances are deleted from the CMDB.** For an example, see ["How to Define an Enrichment Rule – Scenario" below](#).
- **The values of CI attributes are updated.** Use an Enrichment rule to update the attributes of a CI that already exists in the CMDB.

The following Enrichment rule example illustrates that a regular **Windows** query node (that already exists in the CMDB) has been updated with an Enrichment rule.



This Enrichment rule states that every **Windows** CI found in the CMDB is updated with the attribute value defined in the Enrichment rule.

## How to Define an Enrichment Rule – Scenario

This task describes how to create the following Enrichment rule:

An **IP Address** CI is connected to two identical **Node** CIs: one **Node** CI is identified by its IP address and the other is identified by its lowest MAC address. For every such instance, delete the **Node** CI that is identified by its IP address from the CMDB.

**Note:** To reach the required result, you must implement each one of the following steps.

This task includes the following steps:

- ["Create an Enrichment TQL Query" below](#)
- ["Define the Query Node of Type Node that Is Identified by its Lowest MAC Address" on page 534](#)
- ["Define the Query Node of Type Node that is Identified by its IP Address" on page 534](#)
- ["Define the Enrichment Rule" on page 535](#)

### 1. Create an Enrichment TQL Query

To create an Enrichment TQL query, you need to define an Enrichment rule and then add the regular TQL query nodes and relationships that define the query.

**Note:** You can add Enrichment query nodes and relationships only after at least one regular query node has been added to the query.

Select **Managers > Modeling > Enrichment Manager**. For details about how to create an Enrichment TQL query, see ["New Enrichment Rule/Enrichment Rule Properties/Save As Enrichment Rule Wizard" on page 547](#). For details about how to add query nodes and relationships to a query, see ["How to Add Query Nodes and Relationships to a TQL Query" on page 26](#).

You can add query nodes of a federated CI type to the Enrichment TQL query, but if the actions defined in the Enrichment rule affect those query nodes, their source is automatically set to **UCMDB** when you save the rule. You cannot update or delete a federated query node or a relationship to or from a federated query node.

#### Example of an Enrichment TQL Query:

A new Enrichment TQL query called `doubleHosts1` (located under the **Network** folder) is created in Enrichment Manager.

Rule Name:

Rule Description:

Rule is Active

The **doubleHosts1** Enrichment rule is displayed in the Enrichment Rules pane.

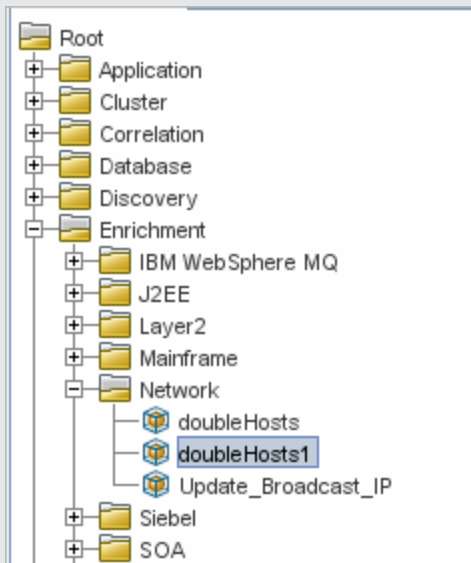

In this Enrichment TQL query, an **IP Address** query node is linked to two query nodes of type **Node** by a **Containment** relationship. The query results must comply with the direction of the arrows.

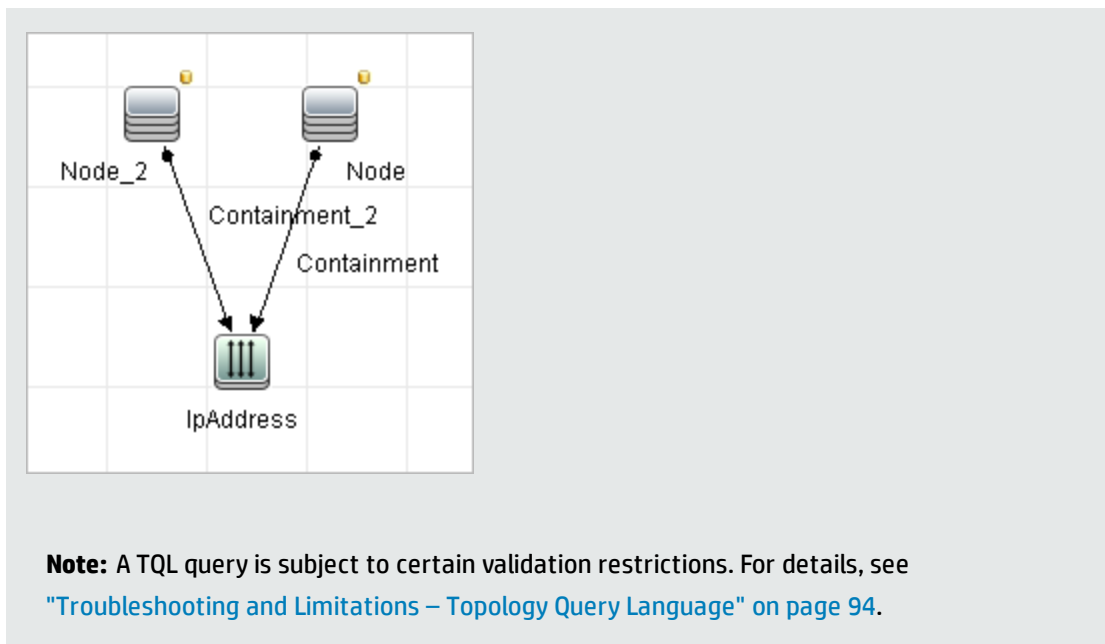

## 2. Define the Query Node of Type Node that Is Identified by its Lowest MAC Address

At the top of the Enrichment Manager page, select **Query** mode. In the editing pane, right-click the required query node of type **Node**, select **Query Node Properties** to open the Query Node Properties dialog box. Then define an attribute condition in the Attribute tab. For details on how to define an attribute condition, see ["Query Node/Relationship Properties Dialog Box" on page 73.](#)

### Example of an Attribute Condition Definition that Identifies the Node by its Lowest MAC Address:

In the Attribute tab, this attribute condition definition identifies the required Node by its lowest MAC address.

- **Attribute name** — Node is Complete
- **Operator** — Equal
- **Value** — True

## 3. Define the Query Node of Type Node that is Identified by its IP Address

At the top of the Enrichment Manager page, select **Query** mode. In the editing pane, right-click the required query node of type **Node**, and select **Query Node Properties** to open the Query Node

Properties dialog box. Then define two attribute conditions in the Attribute tab. For details on how to define an attribute condition, see ["Query Node/Relationship Properties Dialog Box" on page 73](#).

**Example of an Attribute Condition that Enables a Node to Be Identified by its IP Address:**

This attribute condition is the first attribute condition you need to define in the Attribute tab to enable the query node of type node to be identified by its IP Address.

**Attribute name** — Node is Complete

**Operator** — Equal

**Value** — False

This is the second attribute condition you need to define in the Attribute tab to enable the query node of type node to be identified by its IP address.

**Attribute name** — Node is Complete

**Operator** — Is null

**Value** — Value cannot be changed

#### 4. Define the Enrichment Rule

Define the Enrichment rule that deletes all instances of the query node of type **Node** that are identified by their IP addresses. From the toolbar, select **Enrichment** mode. In the Enrichment Rules pane, select the **doubleHosts1** Enrichment rule. Then right-click the query node of type **Node** that is identified by its IP address and select **Delete Relationship/Query Node Item**.

**Example of a Query Node of Type Node Containing a Removed Indicator:**

The query node of type **Node** now has a removed indicator to denote that all node instances that have identical attribute and cardinality settings are removed from the CMDB. The Enrichment query now looks like this.

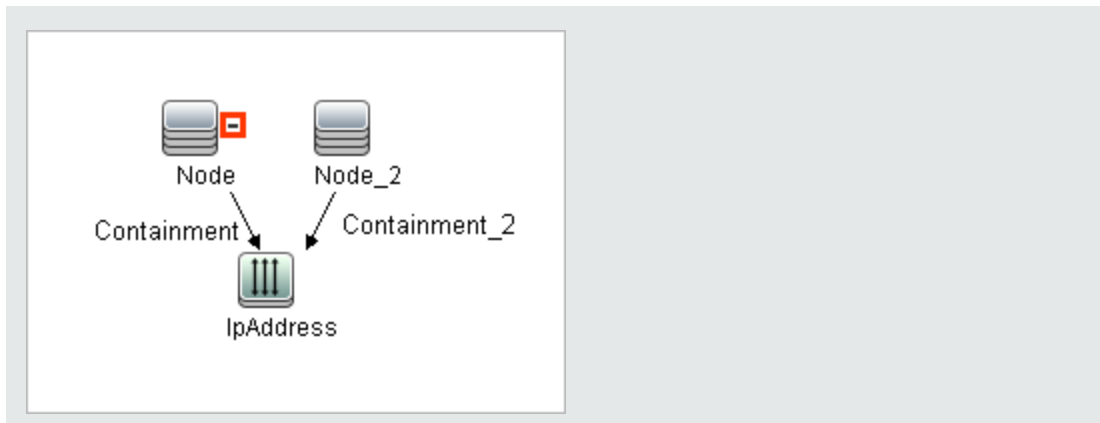



## How to Add Enrichment Query Nodes and Relationships to an Enrichment TQL Query

This section describes how to add Enrichment query nodes and relationships to an Enrichment TQL query in Enrichment Manager.

### To add Enrichment query nodes and relationships to a TQL query:

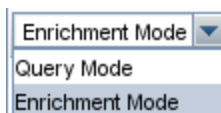
1. From the tree in the Enrichment Rules pane, select the Enrichment rule to which you want to add Enrichment query nodes and relationships or create a new one. For details, see ["New Enrichment Rule/Enrichment Rule Properties/Save As Enrichment Rule Wizard" on page 547](#).
2. From the **Query/Enrichment** drop-down at the top of the page, select **Enrichment Mode**.



3. From the tree displayed in the CI Type Selector, click and drag the query nodes you want to function as an Enrichment query node on to the editing pane. These are the TQL query nodes that are included in the query. Added Enrichment query nodes are displayed by an added  indicator.

**Note:** You can add more than one Enrichment query node to a rule.

4. Link the Enrichment query node to an existing TQL query node or query nodes, to provide the



Enrichment query node with the needed context for its operation.

The following are the Enrichment rule validations:

- You must link the new Enrichment query node to at least one of the existing TQL query nodes in the rule.
  - Enrichment query nodes can only be linked to one another with an Enrichment relationship.
  - If the new Enrichment query node must be contained (according to its CIT definition) in another query node, you must use the **Composition** relationship to connect this Enrichment query node to an existing TQL query node.
  - You cannot link an Enrichment query node to a TQL query node that is hidden.
5. To add a relationship between two query nodes, do one of the following:
- Select the required query nodes by holding the **CTRL** key and clicking the TQL query nodes, right-click and select **Add Relationship**.

- Click the **Create Relationship**  button and draw a line between the required query nodes.

Added Enrichment relationships are displayed by an added  indicator.

The Add Relationship dialog box opens. For details, see "[Add/Edit Relationship Dialog Box](#)" on [page 54](#).

6. Click **OK**. The selected query nodes are linked by the relationship you have selected.

## How to Define a Tenant Association Rule

The following task describes how to define a Tenant Association rule.

**Note:** This task is only relevant when multi-tenancy is enabled.

### 1. Run the New Tenant Association Rule Wizard

In Enrichment Manager, click the small arrow next to the **New Enrichment Rule**  button and select **New Tenant Association Rule**. Enter the general attributes and base query information on

the wizard pages. For details, see ["New Tenant Association Rule/Tenant Association Rule Properties/Save As Tenant Association Rule Wizard"](#) on page 551.

**Note:** Make sure to select the **Rule is Active** check box on the Rule General Attributes page of the wizard to activate the rule.

## 2. Build the Rule Query

If you are basing your Tenant Association rule on a new query, build the query by dragging the required CITs onto the canvas and inserting the required relationships.

## 3. Update the Owner Tenant of a Selected Query Node

Right-click the query node to be updated by the Tenant Association rule and select **Update Owner Tenant**. The Update Owner Tenant dialog box opens. Select the method by which to update the owner tenant (**By value** or **By attribute**) and select the required parameters for that option. Click **OK**. For details, see ["Update Owner Tenant Dialog Box"](#) on page 560.

**Note:** You can update the owner tenant of more than one query node in the rule.

## 4. Update the Consumer Tenants of a Selected Query Node

Right-click the query node to be updated by the Tenant Association rule and select **Update Consumer Tenants**. The Update Consumer Tenants dialog box opens. Select the method by which to update the consumer tenants (**By value** or **By attribute**) and select the required parameters for that option. Click **OK**. For details, see ["Update Consumer Tenants Dialog Box"](#) on page 559.

**Note:**

- You can update the consumer tenants of more than one query node in the rule.
- You can update both the owner tenant and the consumer tenants of the same query node in a single Tenant Association rule.

## 5. Save the Rule

Click **Save**  to save the Tenant Association rule. The rule runs according to the frequency defined by its priority.

## Enrichment Manager User Interface

This section includes (in alphabetical order):

Enrichment Manager Page .....	539
New Enrichment Rule/Enrichment Rule Properties/Save As Enrichment Rule Wizard .....	547
New Tenant Association Rule/Tenant Association Rule Properties/Save As Tenant Association Rule Wizard .....	551
Query Node/Relationship Definition Dialog Box .....	555
Query Node Definition – Advanced Attribute Dialog Box .....	557
Update Consumer Tenants Dialog Box .....	559
Update Owner Tenant Dialog Box .....	560

### Enrichment Manager Page

This page enables you to define Enrichment rules. These rules, which are based on a specific TQL query, can be used for several purposes, including:

- Adding new CIs and relationships to the CMDB.
- Deleting specific CI instances from the CMDB.
- Updating the attribute values of specific CI instances in the CMDB.







<b>To access</b>	Select <b>Enrichment Manager</b> from the Navigation Menu or select <b>Managers &gt; Modeling &gt; Enrichment Manager</b> .
<b>Important information</b>	Enrichment Manager has two modes in which you can work. Always check the <b>Enrichment/Query mode</b> list on the toolbar to verify the currently selected mode.
<b>Relevant tasks</b>	<a href="#">"How to Define an Enrichment Rule – Scenario" on page 531</a> <a href="#">"How to Define a Tenant Association Rule" on page 537</a>
<b>See also</b>	<ul style="list-style-type: none"> <li>• <a href="#">"Enrichment Manager Overview" on page 529</a></li> <li>• <a href="#">"Enrichment Manager User Interface" above</a></li> </ul>



## Enrichment Rules Pane

This area displays a hierarchical tree structure of predefined folders and Enrichment rules. Each Enrichment rule is associated with a TQL query.

<b>Important information</b>	<p>You can create your own Enrichment rule, or work with the out-of-the-box (factory) Enrichment rules provided with your HP Universal CMDB installation.</p> <p>The default folders are provided for the out-of-the-box queries. You can modify these folders, or add additional folders according to your organization's requirements.</p> <p>You can drag and drop Enrichment rules or folders to move them from one folder to another.</p>
------------------------------	--

User interface elements are described below:

UI Element (A-Z)	Description
	<b>New Folder.</b> Creates a new folder.
	<p><b>New.</b> Creates an Enrichment rule. Opens the New Enrichment Rule wizard.</p> <p><b>Note:</b> In a multi-tenancy environment, click the small arrow to the right of the button to display the options. <b>New Enrichment Rule</b> opens the New Enrichment Rule wizard. <b>New Tenant Association Rule</b> opens the New Tenant Association Rule wizard.</p>
	<b>Delete.</b> Deletes the selected folder or Enrichment rule.
	<b>Refresh.</b> Refreshes the data content of the hierarchical tree structure that may have been modified by other users.
	<b>Save.</b> Saves the Enrichment rule to the CMDB. (Enabled only when an Enrichment rule is created or when changes are made to an existing one.)
	<b>Properties.</b> Opens the New Enrichment Rule/Properties wizard. Enables you to change the description and the activation state of the Enrichment rule.
	<p><b>Preview.</b> Generates a preview of the results of the selected Enrichment rule.</p> <p><b>Note:</b> This button is not available when multi-tenancy is enabled.</p>

UI Element (A-Z)	Description
	Represents a folder.
	Represents an Enrichment rule.
	Represents a Tenant Association rule.  <b>Note:</b> This icon is only relevant when multi-tenancy is enabled.
<Enrichment Rule tree>	Displays the existing Enrichment rules in tree format.  <b>Note:</b> Only Enrichment rules appear in the tree. TQL queries of type Enrichment (created in the Modeling Studio) do not appear in the tree.

The following elements are available by right-clicking a folder or Enrichment rule:

UI Element (A-Z)	Description
<b>Delete</b>	Deletes the selected folder or Enrichment rule.
<b>Export To XML</b>	Displays a standard Save As dialog box, enabling you to save the Enrichment rule as an XML script. This option can be used to move an Enrichment rule from one workstation to another, provided the related TQL query is also relocated.
<b>Import From XML</b>	Imports XML files that contain saved Enrichment queries to the Enrichment Manager.
<b>New Enrichment Rule</b>	Creates an Enrichment rule. Opens the New Enrichment Rule wizard.
<b>New Folder</b>	Creates a new folder.
<b>New Tenant Association Rule</b>	Creates a Tenant Association rule. Opens the New Tenant Association Rule wizard.
<b>Preview</b>	Generates a preview of the results of the selected Enrichment rule.
<b>Properties</b>	Opens the New Enrichment Rule/Properties wizard. Enables you to change the description and the activation state of the rule.



UI Element (A-Z)	Description
<b>Rename Folder</b>	Renames the folder.
<b>Save</b>	(Enabled only when a new Enrichment query is created or when changes are made to an existing one.) Saves the Enrichment rule to the CMDB.
<b>Save As</b>	Displays the Save As Enrichment Rule wizard, enabling you to define a new name and description for a query. This option can be used for creating a new Enrichment rule based on an existing one.

## Editing Pane

This area enables you to create and define Enrichment query nodes and relationships.

<b>Important information</b>	<ul style="list-style-type: none"> <li>When you select a folder in the Enrichment Rules pane, the editing pane is empty.</li> <li>When you select an Enrichment rule in the Enrichment Rules pane, the editing pane displays the selected rule, which consists of TQL query nodes that are defined in the TQL query and the relationships between them, and the Enrichment query nodes and relationships that are created and added to the rule.</li> <li>The Enrichment Manager has two modes in which you can work: <b>Enrichment</b> mode and <b>Query</b> mode.  The mode in which you are working determines the options that appear in the shortcut menu. For details, see the editing pane description below.</li> <li>You can calculate the number of instances that were created as a result of an Enrichment rule and remove the instances created from an Enrichment rule from the CMDB. For details, see <a href="#">"Additions Count" on page 168</a> and <a href="#">"Remove Enrichment Results" on page 174</a>.</li> </ul>
<b>Relevant tasks</b>	<a href="#">"How to Define an Enrichment Rule – Scenario" on page 531</a>
<b>See also</b>	For details on how to create a TQL query, see <a href="#">"How to Add Query Nodes and Relationships to a TQL Query" on page 26</a> .

User interface elements are described below (unlabeled elements are shown in angle brackets):

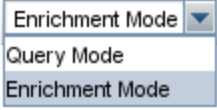



UI Element (A-Z)	Description
	Indicates an added Enrichment query node or relationship.
	Indicates a query node or relationship that has been deleted from the CMDB.
	Indicates an updated query node or relationship.
 <p><b>Query and Enrichment mode</b></p>	<p>The Enrichment Manager has two modes in which you can work: <b>Enrichment</b> mode and <b>Query</b> mode.</p> <p>Working in:</p> <ul style="list-style-type: none"> <li>• <b>Query mode</b> enables you to define regular (non-Enrichment) relationships and query nodes and add them to the TQL query you defined.</li> <li>• <b>Enrichment mode</b> enables you to define Enrichment relationships and query nodes and add them to the TQL query you defined.</li> </ul>
<Main Menu>	For details, see <a href="#">"Main Menu" on page 164</a> .
<Query Node>	A component from which TQL queries are built.
<Relationship>	The entity that defines the relationship between two query nodes.
<Shortcut menu options	For details, see <a href="#">"Shortcut Menu Options" on page 34</a> .
<Toolbar>	For details, see <a href="#">"Toolbar Options" on page 168</a> .
<Tooltips>	<p>Hold the cursor over a query node or relationship to view its tooltip.</p> <p>The tooltips contain the following information:</p> <ul style="list-style-type: none"> <li>• <b>Element name.</b> The name of the query node.</li> <li>• <b>CI Type.</b> The CIT of the query node as defined in the CI Type Manager. For details, see <a href="#">"CI Type Manager" on page 485</a>.</li> <li>• <b>Definitions of the selected query nodes and relationships.</b> The attribute conditions, as described in <a href="#">"Query Node/Relationship Properties Dialog Box" on page 73</a>.</li> </ul>

## CI Type Selector

This area displays a hierarchical tree structure of the CI Types found in the CMDB.

<p><b>Important information</b></p>	<p>The CI Type Selector is part of Enrichment Manager, Impact Analysis Manager, and Trigger TQL Editor.</p> <p>To create or modify a TQL query, click and drag query nodes to the Editing pane and define the relationship between them. Your changes are saved to the CMDB. For details, see <a href="#">"How to Add Query Nodes and Relationships to a TQL Query" on page 26.</a></p> <div style="background-color: #f0f0f0; padding: 5px;"> <p><b>Note:</b> The number of instances of each CIT in the CMDB is displayed to the right of each CIT.</p> </div>
<p><b>Relevant tasks</b></p>	<ul style="list-style-type: none"> <li>• <a href="#">"How to Define an Impact Rule – Workflow" on page 467</a></li> <li>• <a href="#">"How to Define an Enrichment Rule – Scenario" on page 531</a></li> <li>• <a href="#">"How to Define a TQL Query" on page 24</a></li> <li>• <a href="#">"How to Create a Pattern View" on page 271</a></li> </ul>

User interface elements are described below (unlabeled elements are shown in angle brackets):

UI Elements (A-Z)	Description
	<p><b>Add CI Type to Map.</b> Moves the selected CI type to the Editing pane.</p>
	<p><b>Refresh.</b> Refreshes the CI type tree.</p>
	<p><b>Search.</b> Searches for the CI type entered.</p>
	<p><b>Expand All.</b> Expands all subtrees within the CI type tree.</p>
	<p><b>Collapse All.</b> Collapses the subtrees within the CI type tree.</p>
<p>&lt;Search window&gt;</p>	<p>Enter the name or part of a name of a CI type for which to search.</p>

**Shortcut Menu Options**

The CI Type Selector includes the following elements (listed alphabetically) available by right-clicking a CI Type:

Menu Item	Description
<p><b>Add CI Type to Map</b></p>	<p>Select to add the selected CI type to the Editing pane.</p>





Menu Item	Description
<b>Go to CI Type Definition</b>	Takes you directly to the selected CI type in CIT Manager.
<b>Show CIT Instances</b>	Opens the CIT Instances window, which displays all instances of the selected CIT. For details, see <a href="#">"CI Instances Dialog Box" on page 66</a> .

### Advanced Pane

This area displays the properties, conditions, and cardinality for the selected query node and relationship.

<b>Important information</b>	<p>The Advanced pane appears in the lower part of the window in the following managers and user interfaces: Modeling Studio, Impact Analysis Manager, Enrichment Manager, the Input Query Editor and Trigger Query Editor in DFM.</p> <p>A small green indicator  appears next to the tabs that contain data.</p>
<b>Relevant tasks</b>	<ul style="list-style-type: none"> <li>• <a href="#">"How to Define an Impact Rule – Workflow" on page 467</a></li> <li>• <a href="#">"How to Define an Enrichment Rule – Scenario" on page 531</a></li> <li>• <a href="#">"How to Define a TQL Query" on page 24</a></li> <li>• <a href="#">"How to Create a Pattern View" on page 271</a></li> <li>• <a href="#">"How to Create a Template" on page 273</a></li> <li>• <a href="#">"How to Create a Perspective" on page 274</a></li> </ul>

User interface elements are described below:

UI Elements (A-Z)	Description
	If the window is not wide enough to display all the tabs, use the left and right arrows to move to the required tab.
	Click <b>Show List</b> to display a list of the available tabs for the current module. You can select a tab from the list.
<b>Attributes</b>	Displays the attribute conditions defined for the query node or the relationship. For details, see <a href="#">"Attribute Tab" on page 75</a> .

UI Elements (A-Z)	Description
<b>Cardinality</b>	Cardinality defines how many query nodes you expect to have at the other end of a relationship. For example, in a relationship between a node and an IP Address, if the cardinality is 1:3, the TQL query retrieves only those nodes that are connected to between one and three IP Addresses. For details, see <a href="#">"Cardinality Tab" on page 78</a> .
<b>Data Sources</b>	Displays the data sources set for the selected query node.  <b>Note:</b> This tab appears only in the Modeling Studio.
<b>Details</b>	Displays the following information: <ul style="list-style-type: none"> <li>• <b>CI Type/Element Type.</b> The CIT of the selected query node/relationship.</li> <li>• <b>Element Name.</b> The name of the query node or relationship. This appears only in the Modeling Studio.</li> <li>• <b>Show in query results.</b> A green check indicates that the selected query node/relationship is visible in the topology map. A red mark indicates that it is not visible. In the Modeling Studio, this is indicated by the word Yes or No.</li> <li>• <b>Include subtypes.</b> A green check indicates that both the selected CI and its children are displayed in the topology map. A red mark indicates that only the selected CI appears. This item does not appear in the Modeling Studio.</li> </ul>
<b>Edit</b>	Click <b>Edit</b> to open the relevant dialog box for the selected tab.
<b>Element Layout</b>	Displays the attributes selection for the selected query node or relationship. It lists the attributes selected to be included in the query results (when <b>Specific Attributes</b> is selected as the attributes condition). It also lists the excluded attributes and any selected qualifiers for attributes. For details, see <a href="#">"Element Layout Tab" on page 83</a> .  <b>Note:</b> This tab appears only in the Modeling Studio.
<b>Element Type</b>	Displays the subtype conditions defined for the query node or relationship. For details, see <a href="#">"Element Type Tab" on page 81</a> .  <b>Note:</b> This tab appears only in the Modeling Studio.
<b>Enrichment Rules</b>	Displays the Enrichment rule defined for the selected query node or relationship. If the Enrichment rule is used to update the attributes of a CI, click <b>Edit</b> to open the Query

UI Elements (A-Z)	Description
	Node/Relationship Definition dialog box and edit the rule if required. For details, see <a href="#">"Query Node/Relationship Definition Dialog Box"</a> on page 555.  <b>Note:</b> This tab appears only in Enrichment Manager.
<b>Impacted Query Nodes</b>	Indicates which query node is impacted by the changes that occur in the selected trigger query node. If required, you can click <b>Edit</b> to open and modify the Impacted Query Nodes dialog box. For details, see <a href="#">"Impacted Query Nodes Dialog Box"</a> on page 478.  <b>Note:</b> This tab appears only in Impact Analysis Manager.
<b>Qualifiers</b>	Displays the qualifier conditions defined for the query node or the relationship. For details, see <a href="#">"Qualifier Tab"</a> on page 85.  <b>Note:</b> This tab appears only in Enrichment Manager and Impact Analysis Manager.
<b>Selected Identities</b>	Displays the element instances that are used to define what should be included in the TQL query results. For details, see <a href="#">"Identity Tab"</a> on page 86.

## New Enrichment Rule/Enrichment Rule Properties/Save As Enrichment Rule Wizard

This wizard enables you to create or modify an Enrichment rule.

<b>To access</b>	<ul style="list-style-type: none"> <li>To create a new Enrichment rule, right-click anywhere in the Enrichment Rules pane and click <b>New Enrichment Rule</b> or click the <b>New Enrichment Rule</b>  button.</li> <li>To modify an existing Enrichment rule, right-click an Enrichment rule in the Enrichment Rules pane and select <b>Properties</b>.</li> <li>To create a new Enrichment rule based on an existing query, right-click an Enrichment rule in the Enrichment Rules pane and select <b>Save As</b>.</li> </ul>
<b>Important information</b>	<ul style="list-style-type: none"> <li>When creating a new Enrichment rule, bear in mind that the application does not allow you to make any changes in the TQL query that are necessary for the rule. These changes include the following:</li> </ul>

	<ul style="list-style-type: none"> <li>○ Deleting, from the Enrichment TQL query, the query nodes or relationships connected to the Enrichment query node, causing a query node to become unattached to any relationship.</li> <li>○ You cannot change the cardinality definition to 0 (not required) of a query node or relationship that is used in an Enrichment rule. For details on relationship cardinality, see <a href="#">"Query Node/Relationship Properties Dialog Box"</a> on page 73.</li> <li>● An Enrichment TQL query that serves as the basis for Enrichment rules, is subject to certain validation restrictions. For details, see <a href="#">"Troubleshooting and Limitations – Topology Query Language"</a> on page 94. If the TQL query is not valid, you cannot save it.</li> </ul>
<b>Relevant tasks</b>	<a href="#">"How to Define an Enrichment Rule – Scenario"</a> on page 531
<b>Wizard map</b>	The <a href="#">"New Enrichment Rule/Enrichment Rule Properties/Save As Enrichment Rule Wizard"</a> contains:  <a href="#">"Rule General Attributes Page"</a> > <a href="#">"Rule Base Query Page"</a>
<b>See also</b>	<ul style="list-style-type: none"> <li>● <a href="#">"Enrichment Manager Overview"</a> on page 529</li> <li>● <a href="#">"Enrichment Manager User Interface"</a> on page 539</li> <li>● <a href="#">"Topology Query Language"</a> on page 14</li> </ul>

## Rule General Attributes Page

This wizard page enables you to enter a unique name and description for the Enrichment rule.

<b>Important information</b>	<ul style="list-style-type: none"> <li>● An Enrichment TQL query that serves as the basis for Enrichment rules is subject to certain validation restrictions. For details, see <a href="#">"Troubleshooting and Limitations – Topology Query Language"</a> on page 94. If the TQL query is not valid, you cannot save it.</li> <li>● For important information on the effects of making changes to the TQL query after creating it, see <a href="#">"New Enrichment Rule/Enrichment Rule Properties/Save As Enrichment Rule Wizard"</a> on the previous page.</li> <li>● By default, this wizard is set to display a Welcome page. You can choose not to display this page by changing the user preferences. For details, see <a href="#">"User Preferences Dialog Box"</a> on page 93.</li> </ul>
<b>Wizard map</b>	The <a href="#">"New Enrichment Rule/Enrichment Rule Properties/Save As Enrichment Rule Wizard"</a> contains:

	<a href="#">"Rule General Attributes Page"</a> > <a href="#">"Rule Base Query Page"</a>
<b>See also</b>	<a href="#">"Topology Query Language"</a> on page 14

User interface elements are described below:

<b>UI Element (A-Z)</b>	<b>Description</b>
<b>Rule Description</b>	(Optional) Enter a description of the rule.
<b>Rule is Active</b>	<p>(Optional) Select this option to activate the rule in the system as soon as it is saved.  <b>Default:</b> Not selected.</p> <div style="background-color: #f0f0f0; padding: 10px;"> <p><b>Note:</b></p> <ul style="list-style-type: none"> <li>• If an active Enrichment rule is deactivated (by clearing the <b>Rule is Active</b> check box), all changes that occur in the CMDB relating to the rule are deleted from the system. When you deactivate an Enrichment rule, a red X appears next to the Enrichment rule in the Enrichment Rules pane.</li> <li>• To reactivate the rule, right-click the rule in the Enrichment Rules pane and select <b>Properties</b>. In the General Attributes page, select <b>Rule is Active</b>.</li> </ul> </div>
<b>Rule Name</b>	<p>Enter a unique name for the Enrichment rule. The rule name cannot contain any of the following characters: \ / : " &lt; &gt;   % ?. The final character cannot be a blank space.</p> <div style="background-color: #f0f0f0; padding: 10px;"> <p><b>Note:</b> If the rule name is either empty, contains a name used by another Enrichment rule, or uses invalid characters, the <b>Next</b> and <b>Finish</b> buttons are disabled.</p> </div>
<b>Update Last Access Time</b>	<p>When this option is selected, the Enrichment rule updates the Last Access Time property of the CIs it affects. When the check box is cleared, the Enrichment rule does not update the attribute and therefore does not perform touch on those CIs. This ensures that the Enrichment rule does not affect the aging of the relevant CIs.</p> <div style="background-color: #f0f0f0; padding: 10px;"> <p><b>Note:</b></p> <ul style="list-style-type: none"> <li>• For out-of-the-box Enrichment rules, this option is selected by default.</li> <li>• For new CIs created by the Enrichment rule, the Last Access Time property is updated even when the check box is cleared.</li> </ul> </div>

## Rule Base Query Page

This wizard page enables you to define the properties of the TQL query on which the Enrichment rule is based.

<p><b>Important information</b></p>	<ul style="list-style-type: none"> <li>• An Enrichment TQL query that serves as the basis for Enrichment rules, is subject to certain validation restrictions. For details, "<a href="#">Troubleshooting and Limitations – Topology Query Language</a>" on page 94. If the TQL query is not valid, you cannot save it.</li> <li>• For important information on the effects of making changes to the TQL query after creating it, see "<a href="#">New Enrichment Rule/Enrichment Rule Properties/Save As Enrichment Rule Wizard</a>" on page 547.</li> <li>• By default, this wizard is set to display a Completion page after clicking <b>Next</b> on this page. You can choose not to display the Completion page by changing the user preferences. For details, see "<a href="#">User Preferences Dialog Box</a>" on page 93.</li> </ul>
<p><b>Wizard map</b></p>	<p>The "<a href="#">New Enrichment Rule/Enrichment Rule Properties/Save As Enrichment Rule Wizard</a>" contains:</p> <p>"<a href="#">Rule General Attributes Page</a>" &gt; "<a href="#">Rule Base Query Page</a>"</p>
<p><b>See also</b></p>	<p>"<a href="#">Topology Query Language</a>" on page 14</p>



User interface elements are described below:

UI Element (A-Z)	Description
<p><b>Base the Enrichment rule on a new query</b></p>	<p>Select this check box if you want to base the Enrichment rule on a new TQL query. The TQL results are based on the attributes defined for the new TQL query.</p>
<p><b>Base the Enrichment rule on an existing query</b></p>	<p>Select this check box if you want to base the Enrichment rule on an existing TQL query. Select the required Enrichment TQL query from the drop-down list.</p> <div style="background-color: #f0f0f0; padding: 5px; margin-top: 10px;"> <p><b>Note:</b> You cannot base an Enrichment rule on a TQL query that contains complex class conditions.</p> </div>
<p><b>Base Query Description</b></p>	<p>(Optional) Enter a description of the TQL query.</p>
<p><b>Base Query Name</b></p>	<p>Enter a unique name for the Enrichment TQL query.</p> <p>If you selected the <b>Base the Enrichment rule on an existing TQL</b> option, select</p>

UI Element (A-Z)	Description
	the Enrichment TQL query on which you want to base the rule.
<b>Base Query Priority</b>	Select a priority level for the new TQL query (Low, Medium, High, or Express). This setting determines how often the query is rerun automatically by the system to include updated information from the CMDB.
<b>Save a new query based on the current definition</b>	Select to save a new TQL query based on your Enrichment rule definition. <div style="background-color: #f0f0f0; padding: 5px; margin-top: 10px;"> <b>Note:</b> This field only appears in the Save As Enrichment Rule wizard.                     </div>

## New Tenant Association Rule/Tenant Association Rule Properties/Save As Tenant Association Rule Wizard

This wizard enables you to create or modify a Tenant Association rule.

<b>To access</b>	<ul style="list-style-type: none"> <li>To create a new Tenant Association rule, right-click anywhere in the Enrichment Rules pane and click <b>New Tenant Association Rule</b> or click the down arrow next to the <b>New</b>  button and select <b>New Tenant Association Rule</b>.</li> <li>To modify an existing Tenant Association rule, right-click a Tenant Association rule in the Enrichment Rules pane and select <b>Properties</b>.</li> <li>To create a new Tenant Association rule based on an existing query, right-click a Tenant Association rule in the Enrichment Rules pane and select <b>Save As</b>.</li> </ul>
<b>Important information</b>	<p> denotes an active Tenant Association rule.</p> <p> denotes an inactive Tenant Association rule.</p> <div style="background-color: #f0f0f0; padding: 10px; margin-top: 10px;"> <p><b>Note:</b></p> <ul style="list-style-type: none"> <li>This wizard is only available when multi-tenancy is enabled.</li> <li>A TQL query that serves as the basis for Tenant Association rules is subject to certain validation restrictions. For details, see "<a href="#">Troubleshooting and Limitations – Topology Query Language</a>" on page 94. If the TQL query is not valid, you cannot save it.</li> </ul> </div>
<b>Relevant tasks</b>	<ul style="list-style-type: none"> <li><a href="#">"How to Define a Tenant Association Rule" on page 537</a></li> <li>Multi-Tenancy Workflow in the <i>HP Universal CMDB Administration Guide</i></li> </ul>

<b>Wizard map</b>	The <a href="#">"New Tenant Association Rule/Tenant Association Rule Properties/Save As Tenant Association Rule Wizard"</a> contains:  <a href="#">"Rule General Attributes Page"</a> > <a href="#">"Rule Base Query Page"</a>
<b>See also</b>	<ul style="list-style-type: none"> <li>• <a href="#">"Topology Query Language"</a> on page 14</li> <li>• Multi-Tenancy Overview in the <i>HP Universal CMDB Administration Guide</i></li> <li>• Tenant Association Rules in the <i>HP Universal CMDB Administration Guide</i></li> </ul>

## Rule General Attributes Page

This wizard page enables you to enter a unique name and description for the Tenant Association rule.

<b>Important information</b>	<ul style="list-style-type: none"> <li>• An Enrichment TQL query that serves as the basis for Enrichment rules is subject to certain validation restrictions. For details, see <a href="#">"Troubleshooting and Limitations – Topology Query Language"</a> on page 94. If the TQL query is not valid, you cannot save it.</li> <li>• For important information on the effects of making changes to the TQL query after creating it, see <a href="#">"New Enrichment Rule/Enrichment Rule Properties/Save As Enrichment Rule Wizard"</a> on page 547.</li> <li>• By default, this wizard is set to display a Welcome page. You can choose not to display this page by changing the user preferences. For details, see <a href="#">"User Preferences Dialog Box"</a> on page 93.</li> </ul>
<b>Wizard map</b>	The <a href="#">"New Tenant Association Rule/Tenant Association Rule Properties/Save As Tenant Association Rule Wizard"</a> contains:  <a href="#">"Rule General Attributes Page"</a> > <a href="#">"Rule Base Query Page"</a>
<b>See also</b>	<a href="#">"Topology Query Language"</a> on page 14

User interface elements are described below:

<b>UI Element (A-Z)</b>	<b>Description</b>
<b>Rule Description</b>	(Optional) Enter a description of the rule.
<b>Rule is Active</b>	(Optional) Select this option to activate the rule in the system as soon as it is saved. <b>Default:</b> Not selected.



UI Element (A-Z)	Description
	<p><b>Note:</b></p> <ul style="list-style-type: none"> <li>• If an active Tenant Association rule is deactivated (by clearing the <b>Rule is Active</b> check box), all changes that occur in the CMDB relating to the rule are deleted from the system. When you deactivate a Tenant Association rule, a red X appears next to the rule in the Enrichment Rules pane.</li> <li>• To reactivate the rule, right-click the rule in the Enrichment Rules pane and select <b>Properties</b>. On the General Attributes page, select <b>Rule is Active</b>.</li> </ul>
<b>Rule Name</b>	<p>Enter a unique name for the Tenant Association rule. The rule name cannot contain any of the following characters: \ / : " &lt; &gt;   % ?. The final character cannot be a blank space.</p> <p><b>Note:</b> If the rule name is either empty, contains a name used by another Tenant Association rule, or uses invalid characters, the <b>Next</b> and <b>Finish</b> buttons are disabled.</p>
<b>Update Last Access Time</b>	<p>When this option is selected, the Tenant Association rule updates the Last Access Time property of the CIs it affects. When the check box is cleared, the Tenant Association rule does not update the attribute and therefore does not perform touch on those CIs. This ensures that the Tenant Association rule does not affect the aging of the relevant CIs.</p> <p><b>Note:</b></p> <ul style="list-style-type: none"> <li>• For out-of-the-box Tenant Association rules, this option is selected by default.</li> <li>• For new CIs created by the Tenant Association rule, the Last Access Time property is updated even when the check box is cleared.</li> </ul>

## Rule Base Query Page

This wizard page enables you to define the properties of the TQL query on which the Tenant Association rule is based.

<b>Important information</b>	<ul style="list-style-type: none"> <li>• An Enrichment TQL query that serves as the basis for Enrichment rules, is subject to certain validation restrictions. For details, "<a href="#">Troubleshooting and Limitations – Topology Query Language</a>" on page 94. If the TQL query is not valid, you cannot save it.</li> </ul>
------------------------------	---

	<ul style="list-style-type: none"> <li>For important information on the effects of making changes to the TQL query after creating it, see <a href="#">"New Enrichment Rule/Enrichment Rule Properties/Save As Enrichment Rule Wizard"</a> on page 547.</li> <li>By default, this wizard is set to display a Completion page after clicking <b>Next</b> on this page. You can choose not to display the Completion page by changing the user preferences. For details, see <a href="#">"User Preferences Dialog Box"</a> on page 93.</li> </ul>
<b>Wizard map</b>	<p>The <a href="#">"New Tenant Association Rule/Tenant Association Rule Properties/Save As Tenant Association Rule Wizard"</a> contains:</p> <p><a href="#">"Rule General Attributes Page"</a> &gt; <b><a href="#">"Rule Base Query Page"</a></b></p>
<b>See also</b>	<a href="#">"Topology Query Language"</a> on page 14

User interface elements are described below:

UI Element (A-Z)	Description
<b>Base the Tenant Association rule on a new query</b>	Select this check box if you want to base the Tenant Association rule on a new TQL query. The TQL results are based on the attributes defined for the new TQL query.
<b>Base the Tenant Association rule on an existing query</b>	Select this check box if you want to base the Tenant Association rule on an existing TQL query. Select the required TQL query from the drop-down list.
<b>Base Query Description</b>	(Optional) Enter a description of the TQL query.
<b>Base Query Name</b>	<p>Enter a unique name for the TQL query.</p> <p>If you selected the <b>Base the Tenant Association rule on an existing TQL</b> option, select the TQL query on which you want to base the rule.</p>
<b>Base Query Priority</b>	Select a priority level for the new TQL query (Low, Medium, High, or Express). This setting determines how often the query is rerun automatically by the system to include updated information from the CMDB.
<b>Save a new query based on the current definition</b>	<p>Select to save a new TQL query based on your Tenant Association rule definition.</p> <div style="background-color: #f0f0f0; padding: 5px;"> <p><b>Note:</b> This field only appears in the Save As Tenant Association Rule wizard.</p> </div>

## Query Node/Relationship Definition Dialog Box

This dialog box displays the attributes of the selected query node/relationship. The key attributes and the required attributes of the selected query node appear in bold.

<b>To access</b>	Right-click a query node or relationship when in Enrichment mode (select <b>Enrichment</b> from the <b>Query/Enrichment</b> drop-down list at the top of the Enrichment Manager page) and select <b>Update Relationship/Query Node</b> .
<b>Important information</b>	<p>Use an Enrichment rule to update the value of CI attributes in the CMDB, or to add data to attributes that currently do not have values. You can use this option, for example, for simultaneously adding a note to all CI instances.</p> <p>You must fill in the value of the key attributes and the required attributes of the Enrichment query node. The method you use to define these values determines the number of instances created.</p> <p>If you enter a dynamic value, you can create numerous instances. For example, entering the dynamic value of a host_key for the CIT <b>Node</b> or an IP address attribute for the CIT <b>IpAddress</b>.</p>
<b>Relevant tasks</b>	<a href="#">"How to Define an Enrichment Rule – Scenario" on page 531</a>
<b>See also</b>	<ul style="list-style-type: none"> <li>• <a href="#">"Enrichment Manager Overview" on page 529</a></li> <li>• <a href="#">"Enrichment Manager User Interface" on page 539</a></li> </ul>

### Attributes Area





User interface elements are described below :



<b>UI Element (A-Z)</b>	<b>Description</b>
<b>Name</b>	The attribute name.
<b>Type</b>	The field type of the selected attribute.
<b>Value</b>	<p>The value as defined in one of the following:</p> <ul style="list-style-type: none"> <li>• The <b>Value</b> box in the <b>Set Attributes</b> area.</li> <li>• The combination of the values in the <b>By Attribute</b> boxes in the <b>Set Attributes</b> area.</li> </ul>

UI Element (A-Z)	Description
	<ul style="list-style-type: none"> <li>• The <b>Value</b> column if you selected <b>Simple</b> in the <b>Type</b> column in the Query Node Definition - Advanced Attribute dialog box.</li> <li>• The combination of the values in the <b>Value</b> column and the column to the right of the <b>Value</b> column if you selected <b>By Attribute</b> in the <b>Type</b> column in the Query Node Definition - Advanced Attribute dialog box.</li> </ul>

### Set Attributes Area

User interface elements are described below :

UI Element (A-Z)	Description
<b>Advanced</b>	<p>Define an attribute value using the Query Node Definition - Advanced Attribute dialog box.</p> <p> <b>Advanced.</b> Opens the Advanced Attribute dialog box.</p> <p> <b>Clear.</b> Clears the <b>Value</b> column in the <b>Attributes</b> area.</p> <p><b>Note:</b> This element is only active when an attribute of the field type <b>string</b> is selected.</p>
<b>By Attribute</b>	<p>Define an attribute using attributes from other query nodes in the TQL query.</p> <ul style="list-style-type: none"> <li>• In the box to the left, select the required query node.</li> <li>• In the box to the right, select the query node's required attribute.</li> </ul> <p> <b>Apply.</b> Adds the selected attribute definition to the <b>Value</b> column in the <b>Attributes</b> area.</p> <p> <b>Clear.</b> Clears the <b>Value</b> column in the <b>Attributes</b> area.</p>
<b>RegExp Group</b>	<p>(Appears only when you select an attribute of the field type <b>string</b>.) Enter the group number only if you are adding a regular expression using regular expression syntax. This is the part of the regular expression pattern to focus on when creating the attribute. A</p>



UI Element (A-Z)	Description
	set of parentheses ( ) constitutes a group.
<b>Regular Expression</b>	(Appears only when you select an attribute of the field type <b>string</b> .) Add a regular expression using regular expression syntax. Enter the regular expression pattern.  For examples of how to use regular expression syntax, see " <a href="#">Regular Expression Examples</a> " on page 574.
<b>Value (in the Set Attributes area)</b>	Define a constant value. Enter the required value in the <b>Value</b> box or select a value from the <b>Value</b> list.   <b>Apply.</b> Adds the value definition to the <b>Value</b> column in the <b>Attributes</b> area.   <b>Clear.</b> Clears the <b>Value</b> column in the <b>Attributes</b> area.





## Query Node Definition – Advanced Attribute Dialog Box

This dialog box enables you to define query node and relationship attributes of the type **String** using simple or complex expressions. You can also create complex expressions using regular expression format.

<b>To access</b>	Select an attribute of the type <b>string</b> in the Query Node Definition dialog box. Select <b>Advanced</b> and then click the <b>Advanced</b> button.
<b>Relevant tasks</b>	<a href="#">"How to Define an Enrichment Rule – Scenario" on page 531</a>
<b>See also</b>	<ul style="list-style-type: none"> <li>• <a href="#">"Enrichment Manager Overview" on page 529</a></li> <li>• <a href="#">"Enrichment Manager User Interface" on page 539</a></li> </ul>

User interface elements are described below :

UI Element (A-Z)	Description
	<b>Add.</b> Enables you to define an attribute value using simple or complex expressions. Creates a new entry in the <b>Type</b> column. Click the new entry and select either <b>Simple</b> or <b>By Attribute</b> . For details, see the description for the <b>Type</b> column below.
	<b>Delete.</b> Deletes the selected attribute value.

UI Element (A-Z)	Description
	<b>Up.</b> Moves a selected row up.
	<b>Down.</b> Moves a selected row down.
<b>Advanced Value</b>	(This list is only available if you select <b>By Attribute</b> in the <b>Type</b> column.) Click the entry inside the box and select the required attribute.
<b>Concatenate</b>	Use all the attribute values listed in this dialog box.
<b>RegExp Group</b>	(This list is only available only if you select <b>By Attribute</b> in the <b>Type</b> column.) Click inside the <b>RegExp Group</b> column, click the  button, and enter the group number in the Value for RegExp Group dialog box that opens. This is the part of the regular expression pattern to focus on when creating the attribute. A set of parentheses ( ) constitutes a group.
<b>Regular Expression</b>	(This list is only available if you select <b>By Attribute</b> in the <b>Type</b> column.) Click inside the <b>Regular Expression</b> column, click the  button, and enter the regular expression pattern in the Value for Regular Expression dialog box that opens.  For examples of how to use regular expression syntax, see <a href="#">"Regular Expression Examples" on page 574.</a>
<b>Type</b>	Click the entry inside the <b>Type</b> column and select one of the following options: <ul style="list-style-type: none"> <li>• <b>Simple.</b> Define a constant value using a simple expression.</li> <li>• <b>By Attribute.</b> Define an attribute using attributes from other query nodes in the TQL.</li> </ul> <p><b>Default is:</b> Simple</p>
<b>Use first attribute with value</b>	Use the first attribute value listed in this dialog box that is not empty.
<b>Value</b>	<ul style="list-style-type: none"> <li>• If you select <b>Simple</b> in the <b>Type</b> column, click inside the <b>Value</b> column, click the  button, and enter the required value in the Value for Simple dialog box.</li> </ul> <div style="background-color: #f0f0f0; padding: 10px; margin: 10px 0;"> <p><b>Note:</b> If you define an attribute value using only one Simple expression, the <b>Value</b> column cannot be empty.</p> </div> <ul style="list-style-type: none"> <li>• If you select <b>By Attribute</b> in the <b>Type</b> column, click inside the <b>Value</b> column and select the required value from the list.</li> </ul>

## Update Consumer Tenants Dialog Box

This dialog box enables you to define a rule for updating the consumer tenants of a CI.

<b>To access</b>	In Enrichment Manager, select <b>Enrichment Mode</b> . Right-click the required query node in the Tenant Association rule and select <b>Update Consumer Tenants</b> .
<b>Important information</b>	This dialog box is only available when multi-tenancy is enabled.
<b>Relevant tasks</b>	<a href="#">"How to Define a Tenant Association Rule" on page 537</a>
<b>See also</b>	<ul style="list-style-type: none"> <li>Multi-Tenancy Overview in the <i>HP Universal CMDB Administration Guide</i>.</li> <li>Tenant Association Rules in the <i>HP Universal CMDB Administration Guide</i></li> </ul>

User interface elements are described below:

UI Element (A-Z)	Description
<b>Append selected value to original</b>	When this option is selected, the consumer tenants selected are appended to the original consumer tenants of the updated query node.
<b>Get attribute value from</b>	<p>Select the tenancy attribute of the selected query nodes to apply to the updated query node. The options are:</p> <ul style="list-style-type: none"> <li><b>Owner Tenant attribute.</b> Applies the owner tenants of the selected query nodes as the consumer tenants of the updated query node.</li> <li><b>Consumer Tenants attribute.</b> Applies the consumer tenants of the selected query nodes as the consumer tenants of the updated query node.</li> </ul> <p><b>Note:</b> This element is only relevant when <b>By Attribute</b> is selected.</p>
<b>Override original value</b>	When this option is selected, the consumer tenants selected replace the original consumer tenants of the updated query node.
<b>Select nodes</b>	<p>Move the selected query nodes from the Available Nodes pane to the Selected Nodes pane using the arrow buttons.</p> <p><b>Note:</b> This element is only relevant when <b>By Attribute</b> is selected.</p>
<b>Select tenant</b>	Move the selected tenants from the Available Tenants pane to the Selected

UI Element (A-Z)	Description
	<p>Tenants Pane using the arrow buttons.</p> <p><b>Note:</b> This element is only relevant when <b>By Value</b> is selected.</p>
<b>Update consumer tenants</b>	<p>Select a method for updating the consumer tenants. The available options are:</p> <ul style="list-style-type: none"> <li>• <b>By Value.</b> Select tenants directly from the available tenants.</li> <li>• <b>By Attribute.</b> Select other query nodes in the rule. The updated query node is assigned the consumer tenants of the selected query nodes.</li> </ul>

## Update Owner Tenant Dialog Box

This dialog box enables you to define a rule for updating the owner tenant of a CI.

<b>To access</b>	In Enrichment Manager, select <b>Enrichment Mode</b> . Right-click the required query node in the Tenant Association rule and select <b>Update Owner Tenant</b> .
<b>Important information</b>	This dialog box is only available when multi-tenancy is enabled.
<b>Relevant tasks</b>	<a href="#">"How to Define a Tenant Association Rule" on page 537</a>
<b>See also</b>	<ul style="list-style-type: none"> <li>• Multi-Tenancy Overview in the <i>HP Universal CMDB Administration Guide</i>.</li> <li>• Tenant Association Rules in the <i>HP Universal CMDB Administration Guide</i></li> </ul>

User interface elements are described below:

UI Element (A-Z)	Description
<b>Select tenant</b>	<p>Select a tenant from the drop-down list.</p> <p><b>Note:</b> This element is only relevant when <b>By Value</b> is selected.</p>
<b>Select owner tenant from</b>	<p>Select a query node from the drop-down list.</p> <p><b>Note:</b> This element is only relevant when <b>By Attribute</b> is selected.</p>
<b>Update owner</b>	Select a method for updating the owner tenant. The available options are:



UI Element (A-Z)	Description
<b>tenant</b>	<ul style="list-style-type: none"><li>• <b>By Value.</b> Select a tenant directly from a drop-down list.</li><li>• <b>By Attribute.</b> Select another query node in the rule. The updated query node is assigned the owner tenant of the selected query node.</li></ul>

# HP Universal CMDB Data Model

# Chapter 13: UCMDB Data Model Introduction

This chapter includes:

Universal Data Model (UDM) Overview .....	563
---	-----

## Universal Data Model (UDM) Overview

The Universal Data model (UDM), provides the information model that enables HP Software products to integrate using a common language. The UDM provides the vocabulary in the form of CI types and the relationships between them, and their attributes. This vocabulary and the artifacts derived from it are used to enable integrations in an enterprise environment, to enable faster design and deployment, and to facilitate ease of maintenance and integration evolution. The UDM is applied to many management products and solutions, including HP Universal CMDB and its integrations.

You can generate the UCMDB CI Types and Relationships Information PDF, which provides information on specific CI Types and Relationships in the UDM. For details, see ["Export Selected CITs to PDF Dialog Box" on page 526](#). You can also find a UDM Powerpoint document on the [HP Live Network](#) or access the UCMDB Class Model Reference by selecting **Help > UCMDB Class Model**.

# Chapter 14: Exporting the UCMDB Data Model to a UML Tool

This chapter includes:

Export to UML Tool – Overview .....	564
How to Export the Class Model .....	564
How to Convert XML of a Selected Part of the Class Model .....	565
Export to UML Tool User Interface .....	566
Tool Plug-in Input .....	568

**Note:** Currently, Altova UModel versions 2008 and 2009 are supported.

## Export to UML Tool – Overview

The Export to UML tool enables you to export selected sections of the UCMDB class model to a format compatible with UML tools, and to view the model as a UML diagram.

The input for the tool is the UCMDB class model XML file retrieved by the JMX service

**UCMDB:service=Class Model Services/  
exportClassModelToXml().**

**Note:** To access the JMX console, enter the following address in your browser: **http://<server\_name>:8080/jmx-console**, where **<server\_name>** is the name of the machine on which HP Universal CMDB is installed.

## How to Export the Class Model

This task describes how to use the Export Class Model to UML tool wizard.

This task includes the following steps:

- ["Prerequisites" below](#)
- ["Run the UML Tool" below](#)
- ["View the Exported File in Altova" below](#)

### 1. Prerequisites

Set up the tool by extracting the following zip file to any location:

**<Volume>:\hp\UCMDB\UCMDBServer\tools\ExportClassModel.zip**

### 2. Run the UML Tool

You use the Export Class Model to UML wizard to choose the CIT and its attributes to be exported to the UML tool.

For details on working with the Export to UML wizard, see ["Export Class Model to UML Wizard" on the next page](#).

### 3. View the Exported File in Altova

- a. In Altova, select **File > Import From XMI File**.
- b. Select the XMI file. The class model entry appears in the Model Tree pane.
- c. Right-click the entry and select **Show in new diagram > Content**. Click **OK**.

## How to Convert XML of a Selected Part of the Class Model

This task describes how to use the custom plug-in to convert the XML of a selected part of the class model to the UML tool format.

The plug-in can be either a Java class or an XSLT text file. If you use a Java class, it must implement the **ITransformToUML(ExportToUML.jar)** interface; the **transformToUML()** method receives an XML string as a parameter and returns a byte array that is written to the output file.

For details on the custom plug-in input, see ["Tool Plug-in Input" on page 568](#).

This task includes the following steps:

- ["Activate the Plug-in Using a Java Class" below](#)
- ["Activate the Plug-in Using an XSLT Text File" below](#)

### Activate the Plug-in Using a Java Class

Add the display name and fully-qualified class name to the **config.xml** file in the ExportToUML directory, as follows:

```
<ConverterToUML>
  <Name><display name></Name>
  <Class><fully qualified class name></Class>
</ConverterToUML>
```

Continue with the procedure for exporting the class model. For details, see ["How to Export the Class Model" on page 564](#).

### Activate the Plug-in Using an XSLT Text File

In this case, XSLT from the specified file is applied to the class model XML and is written to the output file.

Add the display name and full path of the XSLT file to the **config.xml** file in the ExportToUML directory, as follows:

```
<ConverterToUML>
  <Name><display name></Name>
  <XsltFile><Full_path_of_the_XSLT_file></XsltFile>
</ConverterToUML>
```

Continue with the procedure for exporting the class model. For details, see ["How to Export the Class Model" on page 564](#).

## Export to UML Tool User Interface

This section includes:

Export Class Model to UML Wizard ..... 566

### Export Class Model to UML Wizard

This wizard enables you to choose the CIT and its attributes to be exported to the UML tool.

<b>To access</b>	Browse to the location where you extracted the tool. Right-click <b>ExportClassModel.jar</b> in the ExportClassModel directory. Select <b>Open With &gt; Java 2 Platform SE binary</b> .
<b>Important information</b>	By default the tool opens the <b>ClassModel.xml</b> file in the ExportClassModel directory. You open other files through the <b>File &gt; Open Class Model File</b> menu.
<b>Relevant tasks</b>	<a href="#">"How to Export the Class Model" on page 564</a>
<b>Wizard map</b>	The Export Class Model to UML wizard contains:  <a href="#">"Export Class Model to UML Wizard" on the previous page</a> > <a href="#">"Select Valid Links" below</a> > <a href="#">"Export Selected Items" on the next page</a>
<b>See also</b>	<ul style="list-style-type: none"> <li>• <a href="#">"Export to UML Tool – Overview" on page 564</a></li> <li>• <a href="#">"Tool Plug-in Input" on the next page</a></li> </ul>

User interface elements are described below:

UI Element (A-Z)	Description
<b>File</b>	Displays a list of XML files. Open the file that contains the class model.
<b>Select Attributes Pane</b>	<p>Select the attributes to be displayed in the UML tool.</p> <p>The attributes of the selected CIT are displayed in this pane. The attributes are colored as follows:</p> <ul style="list-style-type: none"> <li>• Attributes inherited from the parent CIT are black.</li> <li>• Attributes specific to this CIT are dark blue.</li> </ul>
<b>Select CI Types Pane</b>	<p>The CITs displayed here are retrieved from the ClassModel.xml file.</p> <p>Select the CIT and its sub nodes to be exported to the UML tool.</p> <p>Use the buttons to select or clear all subindex.</p>

## Select Valid Links

This wizard page enables you to select links that can be used between two CITs.

<b>Important information</b>	General information about the wizard is available in <a href="#">"Export Class Model to UML Wizard" on the previous page</a> .
<b>Wizard map</b>	The Export Class Model to UML wizard contains:  <a href="#">"Select Valid Links"</a> > <a href="#">"Export Selected Items"</a>

User interface elements are described below:

UI Element (A-Z)	Description
	Removes the filter from the list of CITs.
<b>Filter by</b>	Enables you to filter the list of valid links. You can filter the list of CITs and you can sort the list by CIT or relationship.

## Export Selected Items

This wizard page enables you to export the selected CITs and their attributes to the UML tool.

<b>Important information</b>	General information about the wizard is available in <a href="#">"Export Class Model to UML Wizard" on page 566</a> .
<b>Wizard map</b>	The Export Class Model to UML wizard contains:  <a href="#">"Select Valid Links"</a> > <a href="#">"Export Selected Items"</a>

User interface elements are described below:

UI Element (A-Z)	Description
<b>Export</b>	Click to browse to the UML file, in XML format, to which you want to add the UCMDDB CITs and their attributes.  If there are no valid links for a pair of CITs, a <b>no valid links</b> message is displayed in the Select Valid Links page.

## Tool Plug-in Input

The input for the plug-in is an XML string (selected classes/attributes/valid links) in the following form:

```
<?xml version="1.0" encoding="ISO-8859-1"?>
<Class-Model>
  <Class class-name="hostresource" display-name="Host Resource"
visibility="public">
  <Attribute name="isvirtual" display-name="Is Virtual"
visibility="public"/>
  <Attribute name="city" display-name="City" visibility="public"/>
  </Class>
  <Class class-name="host_node" display-name="Computer" visibility="public">
```



```

        <Derived-From class-name="host"/>
    </Class>
    <Class class-name="vax" display-name="VAX" visibility="public">
        <Attribute name="root_actualdeletionperiod" display-name="Actual
Deletion Period" visibility="public"/>
        <Attribute name="data_allow_auto_discovery" display-name="Allow CI
Update" visibility="public"/>
        <Derived-From class-name="host_node"/>
    </Class>
    <Class class-name="host" display-name="Host" visibility="public">
        <Attribute name="host_iscomplete" display-name="Host Is Complete"
visibility="public"/>
        <Attribute name="host_isrout" display-name="Host Is Route"
visibility="public"/>
        <Attribute name="host_hostname" display-name="Host Name"
visibility="public"/>
        <Attribute name="host_os" display-name="Host Operating System"
visibility="public"/>
    </Class>
    <Class class-name="unix" display-name="Unix" visibility="public">
        <Derived-From class-name="host_node"/>
    </Class>
    <Valid-Link ID="host_member_host" display-name="Member"
visibility="public">
        <End1 class-name="host"/>
        <End2 class-name="host"/>
    </Valid-Link>
    <Valid-Link ID="host_container_f_hostresource" display-name="Container
link" visibility="public">
        <End1 class-name="host"/>
        <End2 class-name="hostresource"/>
    </Valid-Link>
</Class-Model>

```

# Reference Information

# Chapter 15: Working with Tables

This chapter includes:

Columns User Interface .....571

## Columns User Interface

This section includes (in alphabetical order):



Select Columns Dialog Box .....571  
Sort Column Content Dialog Box ..... 572



## Select Columns Dialog Box

This dialog box enables you to choose the information you are interested in displaying. You can hide a column or display a hidden column.

<b>To access</b>	Click the <b>Select Columns</b>  button. This button appears above every table in a report.
<b>Important Information</b>	The order of the columns in the list in the Visible Columns pane determines the order of the columns displayed in the table. To change the order of table columns, move them to the required position using the up and down arrow buttons or by dragging a column to a new location.

The following elements are included:

<b>UI Element (A-Z)</b>	<b>Description</b>
	Displays a column. Moves the selected column from the <b>Available Columns</b> pane to the <b>Visible Columns</b> pane.
	Hides a selected column. Moves the selected column from the <b>Visible Columns</b> pane to the <b>Available Columns</b> pane.
	Displays all hidden columns. Moves all the columns from the <b>Available Columns</b> pane to the <b>Visible Columns</b> pane.







UI Element (A-Z)	Description
	Hides all columns. Moves all the columns from the <b>Visible Columns</b> pane to the <b>Available Columns</b> pane.
	Moves a selected column up in the list in the <b>Visible Columns</b> pane.
	Moves a selected column down in the list in the <b>Visible Columns</b> pane.
<b>Available Columns</b>	The columns in this pane do not appear in the table.
<b>Visible Columns</b>	The columns in this pane are visible in the table.

## Sort Column Content Dialog Box

This dialog box enables you to set or change the sort order for the entries displayed in a table.

<b>To access</b>	Click the <b>Sort Column Content</b>  button.
<b>Important Information</b>	<ul style="list-style-type: none"> <li> <b>To sort a table by one column:</b> <p>Move the column name from the <b>Available Columns</b> to the <b>Sorted Columns</b> list. Select the name and decide whether to sort in ascending (upward triangle) or descending (downward triangle) order by clicking the relevant button.</p> </li> <li> <b>To sort a table by more than one column:</b> <p>Move the column names from the <b>Available Columns</b> to the <b>Sorted Columns</b> list. For each column, decide whether to sort in ascending or descending order.</p> </li> <li> <b>To change the order in which columns are sorted:</b> <p>In the <b>Sorted Columns</b> list, select an entry, and click the Up or Down arrow to change the order. (Entries higher in the list are sorted before entries lower in the list.) A number is displayed in the table's column headers.</p> </li> </ul> <p><b>Note:</b> Only columns that are displayed can be sorted. For details on how to define which columns are displayed in the table and in which order, see "<a href="#">Select Columns Dialog Box</a>" on the previous page.</p>

The following elements are included:

<b>UI Element (A-Z)</b>	<b>Description</b>
	Moves the selected column from the <b>Available Columns</b> pane to the <b>Sorted Columns</b> pane. You can double-click the selection to perform the same procedure.
	Moves the selected column from the <b>Sorted Columns</b> pane to the <b>Available Columns</b> pane.
	Moves all the columns from the <b>Available Columns</b> pane to the <b>Sorted Columns</b> pane.
	Moves all the columns from the <b>Sorted Columns</b> pane to the <b>Available Columns</b> pane.
	Moves the selected column up or down in the list to increase or decrease its priority in establishing the sort order.
	Enables you to sort the column content in ascending or descending order.  In the <b>Sorted Columns</b> pane, select a column name and click the ascending or descending button.
<b>Available Columns</b>	The columns whose content is not sorted.  <div style="background-color: #f0f0f0; padding: 5px;"> <b>Note:</b> You can select multiple columns.                     </div>
<b>Sorted Columns</b>	The columns whose content is sorted in either ascending or descending order.

# Chapter 16: Regular Expression Examples

This chapter includes:

Examples of Regular Expressions .....574

## Examples of Regular Expressions

- Enter a regular expression to define an IP address (aa.yy.zz.mm):

To:	In the First Field Enter:	In the Second Field Enter:
Create label by aa	(.*)([.]*[.]*[.]*.*)	1
Create label by yy	(.*[.])(*)([.]*[.]*.*)	2
Create label by zz	(.*[.]*[.])(*)([.]*[.]*.*)	2
Create label by mm	(.*[.]*[.]*[.])(*)(.*)	2

- Enter a regular expression to create the label by the first or last letters of the selected attribute:

To:	In the First Field Enter:	In the Second Field Enter:
Create label by the first letter	(.)(.*)	1
Create label by the last letter	(.*)(.)	2
Create label by the first two letters	(..)(.*)	1
Create label by the last two letters	(.*)(..)	2

# Send Documentation Feedback

If you have comments about this document, you can [contact the documentation team](#) by email. If an email client is configured on this system, click the link above and an email window opens with the following information in the subject line:

**Feedback on Modeling Guide (Universal CMDB 10.21)**

Just add your feedback to the email and click send.

If no email client is available, copy the information above to a new message in a web mail client, and send your feedback to [cms-doc@hp.com](mailto:cms-doc@hp.com).

We appreciate your feedback!