

# HP Service Asset and Configuration Management (SACM) Solution

For Windows Operating System

Software Version: 9.30

## Configuration Guide

Document Release Date: December 2012

Software Release Date: December 2012



## Legal Notices

### Warranty

The only warranties for HP products and services are set forth in the express warranty statements accompanying such products and services. Nothing herein should be construed as constituting an additional warranty. HP shall not be liable for technical or editorial errors or omissions contained herein.

The information contained herein is subject to change without notice.

### Restricted Rights Legend

Confidential computer software. Valid license from HP required for possession, use or copying. Consistent with FAR 12.211 and 12.212, Commercial Computer Software, Computer Software Documentation, and Technical Data for Commercial Items are licensed to the U.S. Government under vendor's standard commercial license.

### Copyright Notice

© Copyright 2005 - 2012 Hewlett-Packard Development Company, L.P.

### Trademark Notices

Adobe™ is a trademark of Adobe Systems Incorporated.

Microsoft® and Windows® are U.S. registered trademarks of Microsoft Corporation.

UNIX® is a registered trademark of The Open Group.

This product includes an interface of the 'zlib' general purpose compression library, which is Copyright © 1995-2002 Jean-loup Gailly and Mark Adler.

## Documentation Updates

The title page of this document contains the following identifying information:

- Software Version number, which indicates the software version.
- Document Release Date, which changes each time the document is updated.
- Software Release Date, which indicates the release date of this version of the software.

To check for recent updates or to verify that you are using the most recent edition of a document, go to:

**<http://h20230.www2.hp.com/selfsolve/manuals>**

This site requires that you register for an HP Passport and sign in. To register for an HP Passport ID, go to:

**<http://h20229.www2.hp.com/passport-registration.html>**

Or click the **New users - please register** link on the HP Passport login page.

You will also receive updated or new editions if you subscribe to the appropriate product support service. Contact your HP sales representative for details.

# Support

Visit the HP Software Support Online web site at:

**<http://www.hp.com/go/hpsoftwaresupport>**

This web site provides contact information and details about the products, services, and support that HP Software offers.

HP Software online support provides customer self-solve capabilities. It provides a fast and efficient way to access interactive technical support tools needed to manage your business. As a valued support customer, you can benefit by using the support web site to:

- Search for knowledge documents of interest
- Submit and track support cases and enhancement requests
- Download software patches
- Manage support contracts
- Look up HP support contacts
- Review information about available services
- Enter into discussions with other software customers
- Research and register for software training

Most of the support areas require that you register as an HP Passport user and sign in. Many also require a support contract. To register for an HP Passport ID, go to:

**<http://h20229.www2.hp.com/passport-registration.html>**

To find more information about access levels, go to:

**[http://h20230.www2.hp.com/new\\_access\\_levels.jsp](http://h20230.www2.hp.com/new_access_levels.jsp)**

---

# Contents

Welcome .....	9
How This Guide is Organized .....	9
Who Should Read This Guide .....	10
Additional Online Resources .....	10
<b>Introduction to SACM .....</b>	<b>12</b>
Service Asset and Configuration Management – Overview .....	12
Installing SACM Products .....	14
SACM Prerequisites .....	15
SACM 9.30 Solution Diagram .....	16
Hardware and Software Requirements .....	17
Supported Versions .....	17
Hardware and Software Requirements .....	17
HP Asset Manager Requirements .....	18
HP Service Manager Requirements .....	21
HP Universal CMDB Requirements .....	22
HP Connect-it Requirements .....	24
SACM Project Planning .....	25
HP Service Asset and Configuration Management .....	25
HP Asset Manager – Overview .....	26
HP Service Manager – Overview .....	27
HP Universal CMDB – Overview .....	27
HP Connect-it – Overview .....	27
<b>HP Service Manager and HP Universal CMDB Integration .....</b>	<b>28</b>
Overview .....	28
Create a New Integration Point .....	28

Set Up SM for Integration with UCMDB .....	29
Add the UCMDB Connection Information to the System Information Record .....	30
Run the Data Push Jobs .....	30
Run the Population Jobs .....	31
<b>Populating HP Universal CMDB from HP Asset Manager .....</b>	<b>32</b>
Overview .....	32
Configure Connection from UCMDB to AM .....	32
Verify UCMDB to AM Configuration .....	35
<b>Data Push from HP Universal CMDB to HP Asset Manager .....</b>	<b>37</b>
Overview .....	37
Configure Connection from AM to UCMDB .....	37
Verify AM to UCMDB Configuration .....	39
<b>HP Asset Manager and HP Service Manager Via CIT Integration .....</b>	<b>40</b>
Overview .....	40
Integrating AM with SM Via CIT .....	40
Verify AM to SM Configuration .....	41
<b>HP Asset Manager Web Configuration .....</b>	<b>42</b>
Overview .....	42
Prerequisites .....	42
Implementing AM Automated Process Manager in Windows .....	42
Tomcat Configurations .....	43
AM Web Service package.properties Parameters .....	43
Update Archive File Using Deployment Script .....	44
Install AM Web Service .....	44
Test for AM Web Service Successful Deployment .....	45
<b>HP Service Manager and HP Asset Manager Integration .....</b>	<b>46</b>
Overview .....	46
Integrating SM with AM Pursuant to Request from Catalog .....	46
Verify SM to AM Configuration .....	50
<b>CI's Reconciliation Priority Best Practices .....</b>	<b>51</b>
Overview .....	51

Priorities Logic .....	51
CI Reconciliation Priority .....	52
<b>Technical Reference .....</b>	<b>54</b>
Overview .....	54
HP Asset Manager > HP Universal CMDB .....	54
What CI data are populated from AM to UCMDB? .....	55
Population TQLs .....	55
Criteria for AM records to be propagated .....	56
What is created in UCMDB during population? .....	59
Reconciliation .....	60
What happens when changes occur in AM during data population? .....	60
Supported CI Types .....	60
Supported CI attributes and the mapping with the AM fields .....	61
CI Type: Asset .....	61
CI Type: IpAddress .....	61
CI Type: Node .....	62
CI Type: CPU .....	63
CI Type: DiskDevice .....	63
CI Type: FileSystem .....	63
CI Type: InstalledSoftware .....	64
CI Type: Interface .....	64
CI Type: LogicalVolume .....	64
CI Type: Printer .....	65
CI Type: Location .....	65
CI Type: BusinessElement .....	65
The configuration files used by the integration .....	66
Where are the configuration files located .....	66
discriminator.properties .....	66
server_desktop_distinguisher.properties .....	67
fixed_values.txt .....	68
location_type_transformer.xml .....	68
condition_rules.xml .....	68

Global_id_mapping.properties .....	70
HP Service Manager <-> HP Asset Manager .....	70
Overview .....	70
What happens when a CI does not exist in SM .....	71
Reconciliation keys for amsm-ppt.scn .....	71
Companies .....	71
Vendors .....	72
Locations .....	72
Departments .....	73
Contacts .....	73
Models .....	74
Stock rooms .....	74
Reconciliation keys for amsm-ci-ppt-link.scn .....	74
Links between device CIs and PPT objects .....	74
Reconciliation keys for smam-ppt.scn .....	75
Locations and their link to a company and a country .....	75
Companies .....	75
SM Companies replicated as AM departments .....	76
Departments .....	76
Contacts .....	76
Operators .....	76
Vendors .....	77
SM vendor sites replicated as companies in AM .....	78
Stocks .....	78
Models .....	78
Reconciliation keys for smam-wo.scn .....	79
Changes > Workorders .....	79
Tasks > Workorders .....	79
For the corresponding CI .....	80
HP Service Manager > HP Universal CMDB .....	80



---

# Welcome

This guide provides information for setting up and configuring the Service Asset and Configuration Management (SACM) solution. This guide outlines the integration between HP Asset Manager, HP Universal CMDB, and HP Service Manager. It explains how to install and configure the components of the integration, as well as outlining how functionality of the integrated applications is enhanced.

**This chapter includes:**

- "How This Guide is Organized" below
- "Who Should Read This Guide" on next page
- "Additional Online Resources" on next page

## How This Guide is Organized

This guide contains the following chapters:

### **Chapter 1 Introduction to SACM**

In addition to providing an overview of the Service Asset and Configuration Management Solution, provides an introduction to SACM integrations and briefly describes how the following products work with each other:

- HP Service Manager (SM)
- HP Universal CMDB (UCMDB)
- HP Asset Manager (AM)
- HP Connect-It (CIT)

### **Chapter 2 HP Service Manager and HP Universal CMDB Integration**

Provides the installation and configuration steps required to configure and verify the integration between Service Manager and Universal CMDB .

### **Chapter 3 Populating HP Universal CMDB from HP Asset Manager**

Provides the installation and configuration steps required to configure and verify the integration of HP Asset Manager to HP Universal CMDB, which involves taking configuration items (CIs) from AM to populate UCMDB.

### **Chapter 4 Data Push from HP Universal CMDB to HP Asset Manager**

Provides the installation and configuration steps required to configure and verify the integration between HP Universal CMDB and HP Asset Manager, which involves taking CIs from UCMDB and pushing them into AM.

### Chapter 5 HP Asset Manager and HP Service Manager Via CIT Integration

Provides the installation and configuration steps required to configure and verify the integration between Asset Manager and Service Manager via CIT.

### Chapter 6 HP Asset Manager Web Configuration

Provides the installation and configuration steps required to configure and verify the Asset Manager Web Configuration.

### Chapter 7 HP Service Manager and HP Asset Manager Integration

Provides the installation and configuration steps required to configure and verify the integration between Service Manager and Asset Manager pursuant to a request from the catalog.

### Chapter 8 CI's Reconciliation Priority Best Practices

Provides the Best Practices guidelines and configuration instructions for how to prioritize the information received from Asset Manager and Service Manager into UCMDB in order for UCMDB to contain the most accurate CI information.

### Appendix A: Technical Reference

Describes how data objects are sourced and mapped by which scenario or adapter, as well as the reconciliation keys used, and any special requirements needed for data transfers to work properly

## Who Should Read This Guide

This solution is intended for IT organizations that want to better manage all their assets from procurement to decommissioning, all the while supplying both operational as well as IT Financial Management data.

This guide is intended for:

- Customers
- Presales and sales personnel
- PSO
- Anyone who wants to learn about the solution, its workflow, and its contribution

The information in this guide may duplicate information available in other SACM documentation, but is provided here for convenience.

## Additional Online Resources

**Troubleshooting & Knowledge Base** accesses the Troubleshooting page on the HP Software Support Web site where you can search the Self-solve knowledge base. Choose **Help >**

**Troubleshooting & Knowledge Base**. The URL for this Web site is <http://h20230.www2.hp.com/troubleshooting.jsp>.

**HP Software Support** accesses the HP Software Support Web site. This site enables you to browse the Self-solve knowledge base. You can also post to and search user discussion forums, submit support requests, download patches and updated documentation, and more. Choose **Help > HP Software Support**. The URL for this Web site is [www.hp.com/go/hpssoftwaresupport](http://www.hp.com/go/hpssoftwaresupport).

Most of the support areas require that you register as an HP Passport user and sign in. Many also require a support contract.

To find more information about access levels, go to:  
[http://h20230.www2.hp.com/new\\_access\\_levels.jsp](http://h20230.www2.hp.com/new_access_levels.jsp)

To register for an HP Passport user ID, go to:  
<http://h20229.www2.hp.com/passport-registration.html>.

**HP Software Web site** accesses the HP Software Web site. This site provides you with the most up-to-date information on HP Software products. This includes new software releases, seminars and trade shows, customer support, and more. Choose **Help > HP Software Web site**. The URL for this Web site is [www.hp.com/go/software](http://www.hp.com/go/software).

**HP Software Solutions Now** accesses the HPSW Solution and Integration Portal Web site. This site enables you to explore HP Product Solutions to meet your business needs, includes a full list of Integrations between HP Products, as well as a listing of ITIL Processes. The URL for this Web site is <http://support.openview.hp.com/sc/solutions/index.jsp>.

# Chapter 1

---

## Introduction to SACM

**This chapter includes:**

Service Asset and Configuration Management – Overview .....	12
SACM 9.30 Solution Diagram .....	16
Hardware and Software Requirements .....	17
SACM Project Planning .....	25
HP Asset Manager – Overview .....	26
HP Service Manager – Overview .....	27
HP Universal CMDB – Overview .....	27
HP Connect-it – Overview .....	27

**Note:** If you have any feedback or comments, please contact [solutionpackagingandscp@hp.com](mailto:solutionpackagingandscp@hp.com).

## Service Asset and Configuration Management – Overview

SACM provides a necessary data foundation that is core to operating IT. This enables the business to function within its own constraints while taking into account the unique needs of the business. Many key IT (ITIL) processes rely on SACM being in place in the organization; including all of the following:

- Service Portfolio Management (Service Strategy)
- IT Financial Management (Service Strategy)
- Service Level Management (Service Design)
- Incident Management (Service Operations)
- Problem Management (Service Operations)
- Request Management (Service Operations)
- Configuration Management (Service Transition)
- Change Management (Service Transition)

By enabling and supporting these processes, SACM contributes to:

- Planning and proactive management of IT to support the needs of the business.
- Financial traceability—the ability to understand where the IT budget is being spent and in support of which business drivers  
This also supports better financial decision making in general and specifically determining if the IT budget is truly supporting the important business services that drive the company's revenue stream.
- Maintaining appropriate service levels to support the business adequately IT should not over-deliver, which is expensive and wasteful, or under-deliver, which inhibits the business from producing better results. SACM provides the data points and transparency to more accurately meet business needs.
- Enabling services to be operated effectively and efficiently
- Populating and managing the Configuration Management Database (CMDB)—discovering and recording all the relevant components that comprise the IT environment
- Providing a process for on-boarding Assets and CIs—managing them throughout their respective life cycles and retiring them in an organized manner to minimize the negative impact on the business
- Improving the understanding of the complex interdependencies between the various components of IT and reducing the negative impact they may have on each other
- Standardizing IT environments, resulting in reducing maintenance costs and improving consistency and predictability of IT outcomes

SACM provides these values to the business throughout the entire service life cycle, from request through procurement to deployment into the IT environment, management of the service in production, and ending at the retirement and disposal phases. SACM is responsible for creating and managing the Configuration Management System (CMS) and as such provides IT organizations with more control over their IT environments, better adherence to the policies it defines, and greater accessibility to the necessary information. SACM does so by delivering the following:

- Management and planning: Designing what level of configuration management is needed and how this level will be achieved
- Configuration identification: Establishing a system of classification of Configuration Items (CIs) into types, defining the relevant attributes for each CI type, determining the key attributes and the relationships between the various CI types
- Configuration Control: Governing the addition, removal and updating of each CI and ensuring that the appropriate process and procedures are followed for each such activity
- Status accounting and reporting: Providing an accurate account of the status of each CI/Asset
- Verification and audit: Conducting periodical audits to ensure that there are no discrepancies between the documented and/or desired state of the environment and the actual state

## Installing SACM Products

Before you can install and configure the integration, the SACM products must be installed and accessible by the integration components via the network.

In-depth knowledge and administration privileges to each of the following integration products are required to install, configure and manage the integration successfully.

- HP Asset Manager
- HP Universal CMDB and its probe
- HP Service Manager
- HP Connect-It
- HP Service Manager <-> HP Universal CMDB integration (reuse the CI Types that are mapped from UCMDB to SM)

**Note:** The **HP Universal CMDB to HP Service Manager Integration Guide** to the SM <-> UCMDB integration is provided with SM.

You can access the guide through the SM Help Server.

Refer to the installation guides provided with each of the products that represent the SACM solution.

**Note:** Although not in the scope of the SACM solution, integrating AM with IT infrastructure discovery tools such as HP Discovery and Dependency Mapping Inventory can complement the SACM solution by providing accurate, up-to-date inventory data which serves as the foundation of the SACM solution. It is suggested to implement this integration before installing and configuring the SACM solution.

Refer to the AM support matrix for the supported versions of various discovery tools. Refer to the documentation provided with the discovery tools for integration information.

## SACM Prerequisites

This guide expects that the following products are installed and fully functional:

- **HP Universal CMDB (UCMDB):** Server should be installed. Data flow probe should be connected and running.
- **HP Service Manager (SM):** Server, Client, Help Server, Web Tier, and Content Pack 10 should be installed and running.
- **HP Asset Manager (AM):** Application designer, client, and AM web application.
- **HP Connect-It:** Scenarios from SACM 9.30 kit.

**Note:** This guide assumes that the SACM products are installed in the following default locations:

- Universal CMDB – C:\hp\UCMDB\
- Service Manager – C:\Program Files\HP\Service Manager 9.30
- Asset Manager – C:\Program Files\HP\Asset Manager 9.31 en
- HP Connect-It – C:\Program Files\HP\Connect-It 9.40 en

## SACM 9.30 Solution Diagram

The following diagram displays a typical deployment of the SACM Solution.

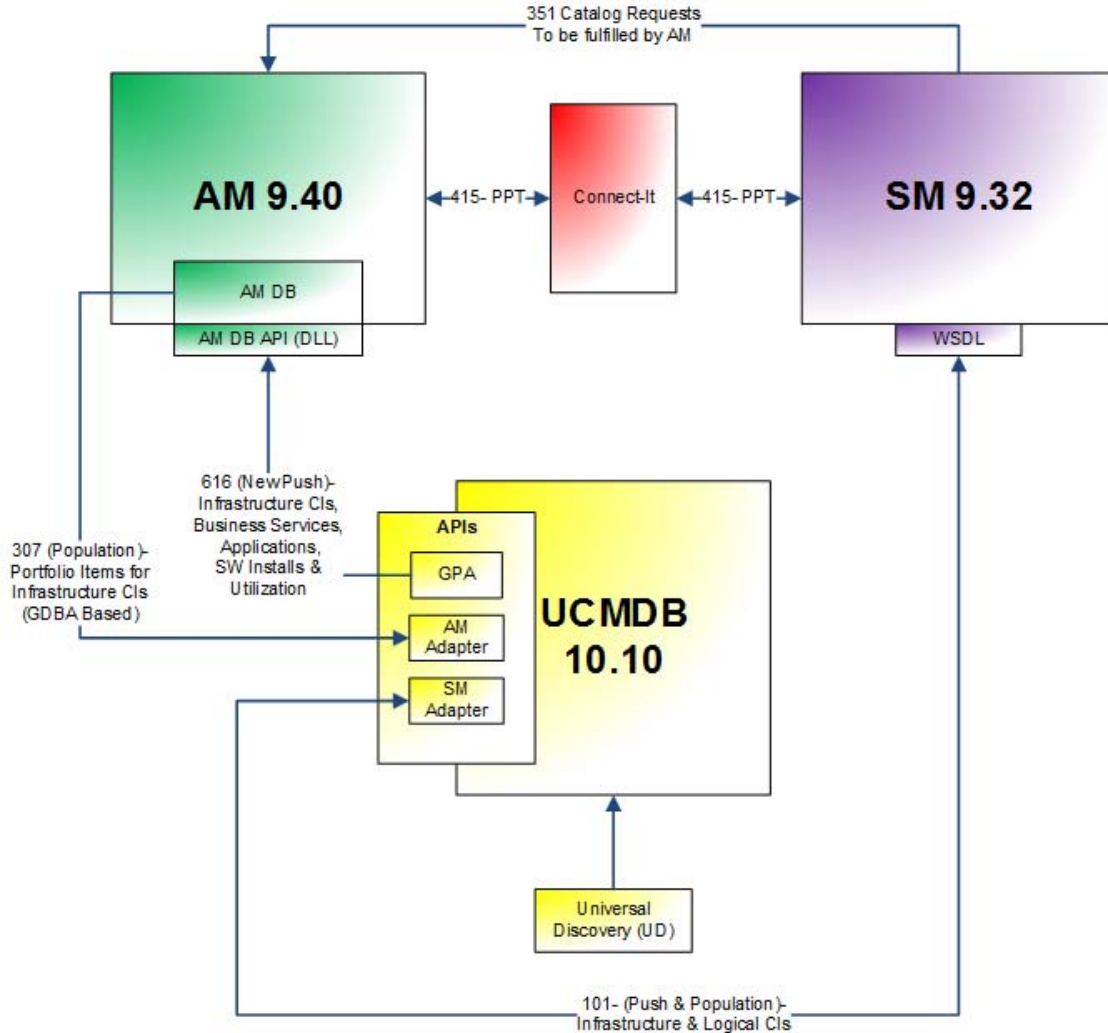

ID#	Integration Name
#351	Employee Self-Service Catalog for Asset Manager (AM - SM)
#415	Reference Data Synchronization via Connect-It (AM <-> SM)
#616	Inventory, Software Utilization and Business Data Synch (UCMDB to AM)
#307	Asset to CI Replication (AM -> UCMDB)
#101	CI sync and actual state federation (UCMDB to SM)



# Hardware and Software Requirements

The instructions in this document assume that products are installed in the default location. If this is not the case, you will need to make the appropriate modifications to file paths mentioned in this document.

**This section also includes:**

Supported Versions ..... 17  
Hardware and Software Requirements ..... 17

## Supported Versions

The following product versions were validated for the SACM 9.30 solution:

Product	Version	Instructions
UCMDB	10.01 or later <b>Recommended:</b> 10.01	For installation instructions, see the <i>HP Universal CMDB Deployment Guide</i> .
Service Manager	9.30 or later <b>Recommended:</b> 9.30 with service pack 7	For installation instructions, see the <i>HP Service Manager Interactive Upgrade Guide</i>
Connect-It	9.40 or later <b>Recommended:</b> 9.40	For installation instructions, see the <i>HP Connect-IT Connector Guide</i> .
Asset Manager	9.31 or later <b>Recommended:</b> 9.31 with the SACM 9.30 content pack	For installation instructions, see the <i>HP Asset Manager Installation and Upgrade</i> .

**Note:** Make sure that each application you install is up and running before you perform any configuration steps.

## Hardware and Software Requirements

**This section includes:**

HP Asset Manager Requirements ..... 18  
HP Service Manager Requirements ..... 21  
HP Universal CMDB Requirements ..... 22  
HP Connect-it Requirements ..... 24

## HP Asset Manager Requirements

<b>Recommendations</b>	<p><b>Asset Manager Client Programs</b></p> <p>The Asset Manager client programs support:</p> <ul style="list-style-type: none"> <li>• Windows</li> <li>• Unix</li> </ul> <p>To find out what operating system versions are supported, consult the Support Matrix at: <a href="http://www.hp.com/go/hpssoftwaresupport">www.hp.com/go/hpssoftwaresupport</a>.</p> <p><b>Asset Manager Database Server</b></p> <p>The server may be used with all the operating systems and hardware platforms supported by your DBMS.</p> <p>To acquire the list of these supported items, refer to the documentation of your DBMS.</p> <p><b>Minimal and recommended system configuration in Windows</b></p> <p><i>Minimal configuration</i></p> <ul style="list-style-type: none"> <li>• <b>All programs except Asset Manager Automated Process Manager and Asset Manager Web and Asset Manager Web Service</b></li> </ul> <table border="1"> <thead> <tr> <th>Environment</th> <th>Windows XP and Server 2003</th> <th>Windows Vista, Windows 7 and Windows Server 2008</th> </tr> </thead> <tbody> <tr> <td><b>CPU</b></td> <td>Intel Xeon or equivalent</td> <td>Intel Xeon or equivalent</td> </tr> <tr> <td><b>RAM</b></td> <td>1 GB</td> <td>2 GB</td> </tr> <tr> <td><b>Disk space (*)</b></td> <td>4 GB (all packages installed)</td> <td>4 GB (all packages installed)</td> </tr> </tbody> </table> <p>(*) The files installed with Asset Manager require about 700 MB disk space (excluding production database and client database layers).</p> <ul style="list-style-type: none"> <li>• <b>Asset Manager Automated Process Manager</b></li> </ul> <table border="1"> <thead> <tr> <th>Environment</th> <th>Windows Server 2003 and Server 2008</th> </tr> </thead> <tbody> <tr> <td><b>CPU</b></td> <td>Intel Xeon dual-core or equivalent</td> </tr> <tr> <td><b>RAM</b></td> <td>1 GB reserved for Asset Manager Automated Process Manager</td> </tr> <tr> <td><b>Disk space</b></td> <td>4 GB</td> </tr> </tbody> </table>	Environment	Windows XP and Server 2003	Windows Vista, Windows 7 and Windows Server 2008	<b>CPU</b>	Intel Xeon or equivalent	Intel Xeon or equivalent	<b>RAM</b>	1 GB	2 GB	<b>Disk space (*)</b>	4 GB (all packages installed)	4 GB (all packages installed)	Environment	Windows Server 2003 and Server 2008	<b>CPU</b>	Intel Xeon dual-core or equivalent	<b>RAM</b>	1 GB reserved for Asset Manager Automated Process Manager	<b>Disk space</b>	4 GB
Environment	Windows XP and Server 2003	Windows Vista, Windows 7 and Windows Server 2008																			
<b>CPU</b>	Intel Xeon or equivalent	Intel Xeon or equivalent																			
<b>RAM</b>	1 GB	2 GB																			
<b>Disk space (*)</b>	4 GB (all packages installed)	4 GB (all packages installed)																			
Environment	Windows Server 2003 and Server 2008																				
<b>CPU</b>	Intel Xeon dual-core or equivalent																				
<b>RAM</b>	1 GB reserved for Asset Manager Automated Process Manager																				
<b>Disk space</b>	4 GB																				

*Recommended configuration*

- **All programs except Asset Manager Automated Process Manager and Asset Manager Web and Asset Manager Web Service**

Environment	Windows XP and Server 2003	Windows Vista, Windows 7 and Windows Server 2008
CPU	Intel Xeon dual-core or equivalent	Intel Xeon or equivalent
RAM	2 GB	2 GB
Disk space (*)	4 GB (all packages installed)	4 GB (all packages installed)

(\*) The files installed with AM (client only) require about 350 MB disk space (excluding production database and database layers).

- **Asset Manager Automated Process Manager**

Environment	Windows Server 2003 and Server 2008
CPU	Intel Xeon quad-core or equivalent
RAM	2 GB reserved for Asset Manager Automated Process Manager
Disk space	4 GB
Network	High speed link with DBMS server. (For example, Ethernet 100 Mbps or Gigabit) and low latency (<5 ms).

- **Asset Manager Web**

For details of the configuration needed to support AM Web, see the **AM 5.20 Sizing Guide Using Oracle DB2 or MSSQL**. This White Paper is delivered in the locations indicated in the **Release Notes, Related documentation** chapter, **Asset Manager reference documents/ White papers** section.

**Supported DBMSs**

The following DBMSs are supported for the AM database:

- Microsoft SQL Server
- Oracle Database Server
- IBM DB2 UDB

	<p>To find out what DBMS versions are supported (servers, clients, network protocols, drivers, etc.) consult the Support Matrix at:</p> <p><a href="http://www.hp.com/go/hpssoftwaresupport">www.hp.com/go/hpssoftwaresupport</a>.</p> <p><b>Warning:</b> We do not guarantee the proper functioning of AM with versions (even later versions) or Service Packs different from those described in the Support Matrix.</p> <p><b>Warning:</b> We do not guarantee the proper functioning of AM with versions or Service Packs that are no longer supported by their respective vendors.</p>
--	--

## HP Service Manager Requirements

<b>Recommendations</b>	<p><b>Service Manager Server</b></p> <ul style="list-style-type: none"><li>• X86-64 Server</li></ul> <p><b>Operating Systems</b></p> <ul style="list-style-type: none"><li>• Windows 2008+</li><li>• Red Hat Enterprise Linux 5.4+</li></ul> <p>For more supported platforms, refer to the product compatibility guide.</p> <p><b>RDBMS</b></p> <ul style="list-style-type: none"><li>• Oracle 11.1</li><li>• Oracle 11.2</li></ul> <p>For more details about supported RDBMS, refer to the product compatibility guide.</p> <p><b>Service Manager Client</b></p> <p><b>Operating Systems:</b></p> <ul style="list-style-type: none"><li>• Windows XP</li><li>• Windows Vista</li><li>• Windows 7</li></ul> <p><b>Service Manager Web Tier</b></p> <ul style="list-style-type: none"><li>• X86-64 Server</li></ul> <p><b>Operating Systems:</b></p> <ul style="list-style-type: none"><li>• Windows 2008+</li><li>• Red Hat Enterprise Linux 5.4+</li></ul> <p><b>Application Server</b></p> <ul style="list-style-type: none"><li>• Apache Tomcat 5.5.33</li><li>• Apache Tomcat 6.0</li></ul> <p><b>Web Server:</b></p> <ul style="list-style-type: none"><li>• Apache Web Server 2.2</li></ul> <p>For more details about supported Web and Application Servers, refer to the product compatibility guide.</p>
------------------------	--

## HP Universal CMDB Requirements

<b>Recommendations</b>	<p><b>Server Software Requirements:</b></p> <p>Hardware Platform: x86-64</p> <ul style="list-style-type: none"><li>• Recommended: Windows 2008: Enterprise SP2, R2, and R2 SP1 64-bit</li><li>• Windows 2008: Standard R2 and R2 SP1 64-bit</li><li>• Red Hat Linux 5.x: Enterprise/Advanced 64-bit</li><li>• Red Hat Enterprise Linux Server 6.2 and higher: 64-bit</li></ul> <p><b>Computer/processor</b></p> <p>Windows/Linux: To fulfill the CPU requirements, you must have one of the following:</p> <ul style="list-style-type: none"><li>• Intel Dual Core Xeon Processor 2.4 GHz or later</li><li>• AMD Opteron Dual Core Processor 2.4 GHz or later</li></ul> <p>In addition to the above requirements, you must have the following number of CPU Cores, depending on your deployment configuration:</p> <ul style="list-style-type: none"><li>• Small deployment: 1 CPU</li><li>• Standard deployment: 4 CPUs</li><li>• Enterprise deployment: 8 CPUs</li></ul> <p><b>Note:</b> As UCMDB performance is dependent upon processor speed, to ensure proper UCMDB performance, it is recommended that you use the fastest possible processor speed.</p> <p><b>Memory:</b></p> <p>For Windows/Linux:</p> <ul style="list-style-type: none"><li>• Small deployment: 4 GB RAM</li><li>• Standard deployment: 8 GB RAM</li><li>• Enterprise deployment: 16 GB RAM</li></ul>
------------------------	---

	<p><b>Memory swap file:</b> For Windows:</p> <ul style="list-style-type: none"><li>• Small deployment: 6 GB (Supported)</li><li>• Standard deployment: 12 GB</li><li>• Enterprise deployment: 24 GB</li></ul> <p>For Linux:</p> <ul style="list-style-type: none"><li>• Small deployment: 4 GB (Supported)</li><li>• Standard deployment: 8 GB</li><li>• Enterprise deployment: 16 GB</li></ul> <p><b>Note:</b></p> <ul style="list-style-type: none"><li>• The virtual memory for Windows should be at least 1.5 times the size of the physical memory.</li><li>• The Linux swap file size should be equal in size to the physical memory.</li></ul> <p><b>Free hard disk space</b></p> <ul style="list-style-type: none"><li>• Minimum 30 GB (for logs, memory dumps, and so on)</li></ul> <p><b>Display: Windows</b></p> <ul style="list-style-type: none"><li>• Color palette setting of at least 256 colors (recommended: 32,000 colors)</li></ul>
--	---

**Note:**

- Windows 2003 is no longer supported in UCMDB 10.00.
- Installation of UCMDB is not supported on 32-bit machines.

## HP Connect-it Requirements

Recommendations	Hardware
	<ul style="list-style-type: none"><li>• Windows configuration<ul style="list-style-type: none"><li>▪ CPU: Dual-core 2 GHz</li><li>▪ RAM: 2 GB</li></ul></li><li>• Unix configuration<ul style="list-style-type: none"><li>▪ CPU: Dual-core 2 GHz</li><li>▪ RAM: 2 GB</li></ul></li></ul> <p><b>Operating Systems</b></p> <ul style="list-style-type: none"><li>• <b>Solaris 9</b><ul style="list-style-type: none"><li>▪ conitsvc: 7 MB</li><li>▪ cntrsv: 8 MB</li></ul></li><li>• <b>HP-UX</b><ul style="list-style-type: none"><li>▪ conitsvc: 7 MB</li><li>▪ cntrsv: 6 MB</li></ul></li><li>• <b>AIX 5.1</b><ul style="list-style-type: none"><li>▪ conitsvc: 4 MB</li><li>▪ cntrsv: 5 MB</li></ul></li><li>• <b>Linux</b><ul style="list-style-type: none"><li>▪ conitsvc: 6 MB</li><li>▪ cntrsv: 7 MB</li></ul></li><li>• <b>Web server</b><ul style="list-style-type: none"><li>▪ <b>Tomcat: 256 MB</b><ul style="list-style-type: none"><li>▪ Memory for conitsvc depends on the size of the documents processed.</li><li>▪ For cntrsv: the memory used by a Java connector may be greater than indicated because of the Java Virtual Machine.</li><li>▪ Memory for DLL files required by the connector must be added to the given memory size.</li></ul></li></ul></li></ul>



# SACM Project Planning

## HP Service Asset and Configuration Management

The various tasks that must be done in order to use the SACM solution appear in the following diagram:

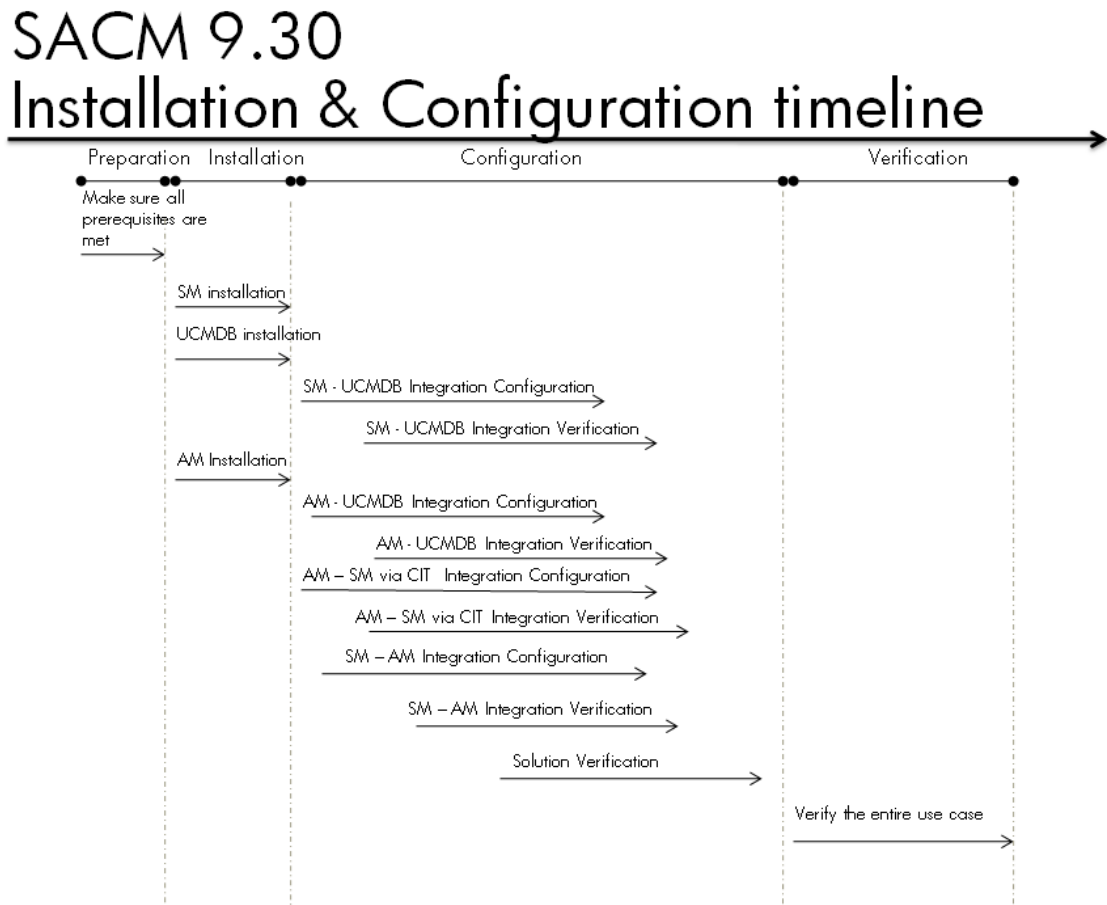

## HP Asset Manager – Overview

HP Asset Manager (AM) helps IT organizations minimize their compliance risk, effectively manage their IT services, and maximize the utilization of IT.

AM supports the life cycle management of physical and logical assets. AM's modules—Asset Tracking, IT Procurement, Contract Management, Software Asset Management and Financial Management—will ensure that IT organizations get full visibility on their portfolio and can smoothly run operations and optimize their use of IT.

AM's main benefits are described as follows:

- **Asset Tracking:**
  - Track and manage fiscally relevant physical and virtual assets throughout their life cycle
  - Optimize IT spending
  - Reduce the number of lost and unused assets
  - Improve IT governance
- **IT Procurement:**
  - Streamline IT procurement life cycle process
  - Optimize purchase costs by tracking vendor prices
  - Manage approvals and fulfillment of requests
  - Measure contract objectives against vendor delivery metrics
- **Contract Management:**
  - Automatically manage the operational state of contracts in use
  - Track compliance with vendor terms and conditions
  - Link assets to contracts (purchase, leasing, maintenance, support contracts)
  - Monitor and re-evaluate contracts and suppliers
  - Optimize cost of IT contracts
- **Software Asset Management (SAM):**
  - Ensure vendor software license compliance using out-of-the-box SAM best practices
  - Allow organizations to optimize what is already owned
  - Enable active management for the authoritative state of software CIs
- **IT Financial Management:**
  - Track cost of assets and business services
  - Define service offerings, manage user subscriptions
  - Support showback/chargeback for use of business services
  - Execute Budget Management Best Practices

## HP Service Manager – Overview

HP Service Manager stores the managed or expected state of CIs and CI relationships as attribute values in a CI record. To be part of the integration, a CI attribute in your UCMDB system must map to a managed field in the SM CI record. You can add, remove, or update the managed fields that are part of the integration by tailoring the SM Web services that manage the integration.

SM runs according to a set of rules that define what actions you want the system to take whenever a CI's actual state does not match the expected state as defined in the CI record. You define these rules from the Discovery Event Manager (DEM) in SM where you can do the following:

- Automatically update a CI record to match the attribute values listed in the actual state. (This is the default behavior.)
- Automatically create a change record to review the differences between the actual state and the managed state.
- Automatically create an incident record to review the differences between the actual state and the managed state.

## HP Universal CMDB – Overview

HP Universal CMDB (UCMDB) consists of a rich business-service-oriented data model with built-in discovery of configuration items (CIs) and configuration item dependencies, visualization and mapping of business services, and tracking of configuration changes.

UCMDB implements data model, data flow management, and data modeling capabilities, and also provides impact analysis, change tracking, and reporting capabilities to transform CMDB data into comprehensible, actionable information that helps answer critical questions and solve business problems.

## HP Connect-it – Overview

Connect-It is an Enterprise Application Integration (EAI) type integration platform. An EAI solution enables a company to integrate the different applications from which it can obtain or to which it can provide internal data (Internal support, equipment management software, and so on) or external data (ERP, B2B, B2C). Connect-It integrates not only data, but also a company's application processes.

You can use Connect-It to:

- Transfer information from one database to another.
- Duplicate the information from one database to another in real-time.
- Import information from e-mails, delimited text files, XML files or other formats into a database.
- Export information from a database to e-mails, delimited text files, XML files or other formats.
- Import NT Security-based information into a database.

## Chapter 2

---

# HP Service Manager and HP Universal CMDB Integration

This chapter includes:

Overview .....	28
Create a New Integration Point .....	28
Set Up SM for Integration with UCMDB .....	29

## Overview

This chapter describes the necessary steps to configure and verify the integration between SM and UCMDB.

## Create a New Integration Point

1. Log on to UCMDB as an administrator.
2. From the left-hand navigation pane, select **Data Flow Management > Integration Studio**.
3. In the Integration Point pane, click the **New Integration Point**  button. The New Integration Point dialog box opens.

Enter the following information:

Name	Recommended Value	Description
<b>Integration Name</b>	<b>SM Integration</b>	The name you give to the integration point.
<b>Adapter</b>	<b>&lt;user defined&gt;</b>	Select the appropriate adapter for the version of SM you are using.
<b>Is Integration Activated</b>	<b>selected</b>	Select this check box to create an active integration point.

4. In the **Adapter Properties** fields, fill in the relevant details.

Name	Recommended Value	Description
<b>Hostname/IP</b>	<b>&lt;user defined&gt;</b>	The name of the SM server.

Name	Recommended Value	Description
<b>Port</b>	<user defined>	The port through which you access SM.
<b>Credentials</b>	<user defined>	<p>If SM credentials appear in the Credentials column, select them.</p> <p>If no SM credentials appear, select <b>Generic Protocol</b> and click the <b>Add new connection details for selected protocol type</b>  button.</p> <p>Enter the following information:</p> <ul style="list-style-type: none"> <li>▪ <b>Description.</b> Enter <b>Service Manager</b>.</li> <li>▪ <b>User Name.</b> Enter the Service Manager user name. The default value is <b>falcon</b>.</li> <li>▪ <b>User Password.</b> Enter and confirm a password.</li> </ul>
<b>Probe Name</b>	<user defined>	Select the name of the Data Flow Probe used to run population jobs.

5. Click **Test Connection**.
6. After the connection success message appears, click **OK**.
7. On the **Federation** tab, select the **Incident**, **Problem**, and **RequestForChange** CI types and click the **Save Integration Point**  button.
8. Log on to the JMX console.
9. From the UCMDB section, select **UCMDB:service=Multiple CMDB Instances Services**.
10. Invoke:
  - **setAsGlobalIdGenerator** and verify it succeeded.
  - **getGlobalIdGeneratorScopes** and verify it succeeded.

## Set Up SM for Integration with UCMDB

This task includes:



Add the UCMDB Connection Information to the System Information Record .....	30
Run the Data Push Jobs .....	30
Run the Population Jobs .....	31

## Add the UCMDB Connection Information to the System Information Record

1. Log on to your SM system as an administrator.
2. From the System Navigator, select **System Administration > Base System Configuration > Miscellaneous > System Information Record**.
3. Click the **Active Integrations** tab.
4. Select the **HP Universal CMDB** option. The form displays the UCMDB Web service field URL.
5. In the UCMDB Web service URL field, enter the URL to the UCMDB Web service API. The URL has the following format:  
**http://<UCMDB server name>:<port>/axis2/services/ucmdbSMSService**.
6. In the UserId dialog box, enter your UCMDB user name and password and click **Save**.



## Run the Data Push Jobs

**Note:** To verify that Data Push is working, find a CI in UCMDB that does not appear in SM.

1. Log on to UCMDB.
2. From the left-hand navigation pane, select **Data Flow Management > Integration Studio**.
3. In the Integration Point pane, click the correct integration.
4. Click the **Data Push** tab. The Job Definition pane appears.
5. Select your job and click the **Run Job – Sync All Data**  button to run the replication job.
6. When the Confirm synchronizing window appears, click **Yes**.
7. Click the **Refresh**  button and wait until the **Succeeded** message appears in the **Status** tab. The updated synchronization status appears.
8. Browse to your SM server.
9. From the System Navigator, select **Configuration Management > Resources > Search CIs**.
10. Click **Search**  and verify that all the CIs from UCMDB are listed in SM.
11. Double-click one CI that is replicated from UCMDB.
12. Drill down to the **Actual State** section and verify that all parameters are OK.
13. Click **View** in UCMDB and verify that UCMDB opens and you can view the CI.

## Run the Population Jobs

**Note:** To verify that population is working, create a new CI in SM.

1. Log on to UCMDB.
2. From the left-hand navigation pane, select **Data Flow Management > Integration Studio**.
3. In the Integration Point pane, click the correct integration.
4. Click the **Population** tab.
5. Select the **SM Configuration Items Population job** and click the **Run Job – Sync All Data**  button to run the population job.
6. When the Confirm synchronizing window is displayed, click **Yes**.
7. Click the **Refresh**  button and wait until the **Succeeded** message appears in the **Status** tab. The updated synchronization status appears.
8. Take the same action with the **SM Relations Population job**.
9. Log on to UCMDB and validate that the CI that was created in SM is validated in UCMDB.

## Chapter 3

---

# Populating HP Universal CMDB from HP Asset Manager

**This chapter includes:**

Overview .....	32
Configure Connection from UCMDB to AM .....	32
Verify UCMDB to AM Configuration .....	35

## Overview

This section describes the necessary steps to configure and verify the integration of AM to UCMDB, which involves taking configuration items (CIs) from AM to populate UCMDB.

## Configure Connection from UCMDB to AM

### Step 1: Get the adapter content package

1. Log on to **UCMDB**.
2. Browse to **Data Flow Management > Adapter Management**.
3. Expand **AMAdapter** from the resources list.
4. Expand **External resources** and select **AMadapter/Content.zip**.
5. Export to the local server and extract all files from **Content.zip**. The **AMdatakit** and **AMDBUpdate** folders are displayed. **AMdatakit** is used to sync **dtLastModif** among **amAsset**, **amPortfolio**, and **amComputer** tables.

### Step 2: Import the workflow into AM

1. Log on to **Asset Manager Client**.
2. Select **File > Import**.
3. Click **Execute a script**.
4. Browse to the Content directory from [Step 1—AMDataKit](#).
5. Select **WF\_SACM.scr**.
6. Enter the password and click **Import**.
7. Confirm the imported workflow by clicking **tools > workflow > workflow schemes** and find **UpdatedtRecCreation**.



## Step 3: Create SQL views in the AM database

**Caution:** This batch file can only be used on Windows computers, not UNIX computers.

The batch file should be run from a computer where the client layers of the DBMS (for example, Oracle Database 10g Client R2) used for the AM database are installed.

Running this batch file alters the AM database structure.

Administrative privileges are required at the DBMS level to create the SQL views.

1. Set the ORACLE\_HOME environment variable.
2. Run the create view script.
  - a. Click **start > Run**.
  - b. Enter **cmd**.
  - c. Enter **sqlplus <schema name>/<schema password>@<SID\_Hostname of oracle server>**.
  - d. Enter **GRANT create ANY VIEW to <Username>**.
  - e. Enter **GRANT SELECT ANY TABLE to <Username>**.
  - f. Enter **GRANT create MATERIALIZED VIEW to <Username>**.
  - g. Enter **exit** to exit Oracle.
3. Browse to the AMDBupdate folder.
4. If using an Oracle server, run the command **CreateViews.bat Oracle <Oracle SID> <Username> <Password>**; for example, **CreateViews.bat Oracle SSG\_labm3amdb35 SACM4 topaz**.  
  
If using an SQL server, run the command **CreateViews.bat [MSSQL2005|MSSQL2008] <Server> <Database> <Username><Password>**.
5. Confirm all views created in the AM database.

## Step 4: Make some CI attributes visible

1. Log on to the **UCMDB Server**.
2. Open a browser and connect to UCMDB Server as an administrator.
3. From the left navigation bar, select **Modeling**.
4. Select **CI Type Manager** and select the CI Type that contains the CI attribute from the navigation tree.
5. On the **Attributes** tab, double click the attribute you want to modify.

By default, the following CI attributes are not visible:

CI Type	Attribute
IpAddress	IP Address
	IP is DHCP
	IpAddressProperty
CPU	CPU Speed
	CpuClockSpeed

6. Select the **Advanced** tab, and select **Visible**.

## Step 5: Create integration point

1. Log on to **UCMDB**.
2. Browse to **Data Flow Management > Integration Studio**.
3. Click the **New Integration Point**  button.
4. In the New Integration Point dialog box, fill in the following **Integration Properties**.

Name	Recommended Value	Description
<b>Integration Name</b>	AM Population and Federation Adapter 9.30	Name given to the integration point.
<b>Is Integration Activated</b>	selected	Select checkbox to create an active integration point.

- In the **Adapter Properties**, fill in the relevant details.

Name	Recommended Value	Description
<b>Hostname/IP</b>	<user defined>	Enter the hostname of the database server.
<b>Database Type</b>	<user defined>	Select the database type— <b>Oracle</b> or <b>SQL</b> .
<b>DB port</b>	<user defined>	Enter the database port default port for Oracle 1521 and SQL 1433.
<b>DB Name/SID</b>	<user defined>	Enter the SID of the database.
<b>Credentials ID</b>	<user defined>	<p>If AM Protocol credentials appear in the <b>Credentials</b> column, select them.</p> <p>If no AM Protocol credentials appear, select <b>Generic Protocol</b> and click the <b>Add new connection details for selected protocol type</b>  button.</p> <p>Enter the following information:</p> <ul style="list-style-type: none"> <li>For the AM User Name, enter <b>Admin</b>.</li> <li>For the AM password, enter the password of the AM log on.</li> <li>For the database user name, enter the name of the schema.</li> <li>For the database password, enter the password of the schema.</li> </ul>
<b>Data Flow Probe</b>	<user defined>	Select the correct Probe from the drop-down list.
<b>Push Back IDs</b>	Enabled	Identify a unique CI if the feature is disabled and the reconciliation of CIs will not work.

- Click **Test connection** and **OK**.

## Verify UCMDB to AM Configuration



**Note:** On first use, run the full population job. After any changes are made, only run the diff population job.

- Log on to **UCMDB**.
- Browse to **Data Flow Management > Integration Studio**.
- Select the **AM Population** integration point.

## Configuration Guide

### Chapter 3: Populating HP Universal CMDB from HP Asset Manager

---

4. In the Integration Jobs pane, select the **Population** tab and click the **AM Population and Federation Adapter 9.30** job.
5. Click the **Run Job – Sync All Data**  button.
6. When the Confirm synchronizing window appears, click **Yes**.
7. Click the **Refresh**  button and wait until the **Succeeded** message appears in the **Status** tab. The updated synchronization status appears.
8. Browse to **Modeling > IT Universe Manager**.
9. Select the **Search CIs** tab.
10. Confirm that CIs from AM moved to UCMDB.

# Chapter 4

---

## Data Push from HP Universal CMDB to HP Asset Manager

This chapter includes:

Overview .....	37
Configure Connection from AM to UCMDB .....	37
Verify AM to UCMDB Configuration .....	39

### Overview

This section describes the necessary steps to configure and verify the integration between UCMDB and AM. which involves taking configuration items (CIs) from UCMDB and pushing them into AM.

### Configure Connection from AM to UCMDB

1. Log on to UCMDB.
2. From the left-hand navigation pane, select **Data Flow Management > Integration Studio**.
3. In the Integration Point pane, click the **New Integration Point**  button. The New Integration Point dialog box opens.

Enter the following information:

Name	Recommended Value	Description
<b>Integration Name</b>	AM Push Integration	The name you give to the integration point.
<b>Adapter</b>	AM Push Adapter	Select the Push Integration.
<b>Is Integration Activated</b>	selected	Select this check box to create an active integration point.



4. Click the **Adapter**  icon to open Content Help for this adapter.
  - a. Navigate to **HP Universal CMDB Discovery and Integration Content Guide > Integrations > HP Asset Manager Push Integration > How to Integrate UCMDB and Asset Manager > Set Up UCMDB**.
  - b. Follow the steps provided.
5. In the **Adapter Properties** fields, fill in the relevant details.

Name	Recommended Value	Description
<b>Hostname</b>	<user defined>	Type the hostname of the database server.
<b>Database Type</b>	<user defined>	Select the database type: <b>Oracle</b> or <b>SQL</b> .
<b>DB port</b>	<user defined>	Type the DB port default port for <b>Oracle 1521</b> and <b>SQL 1433</b> .
<b>DB Name/SID</b>	<user defined>	Type the SID of the database.
<b>Credentials ID</b>	<user defined>	<p>If AM Protocol credentials appear in the Credentials column, select them.</p> <p>If no AM Protocol credentials appear, select <b>Generic Protocol</b> and click the <b>Add new connection details for selected protocol type</b> button.</p> <p>Enter the following information:</p> <ul style="list-style-type: none"> <li>■ Select the database type.</li> <li>■ Type the port number.</li> <li>■ In <b>User name</b>, type the schema user of AM.</li> <li>■ In <b>DB password</b>, type the password of the schema.</li> </ul>
<b>AM Version</b>	<user defined>	Select the AM version.
<b>Data Flow Probe</b>	<user defined>	Select the right Probe from the drill down list.

6. Click **Test Connection** and **OK**.

## Verify AM to UCMDB Configuration

**Note:** On first use, run the full population job. After any changes are made, only run the diff population job.

1. Log on to UCMDB.
2. From the left-hand navigation pane, select **Data Flow Management > Integration Studio**.
3. Select the **AM Push Integration** adapter.
4. In the Integration Jobs, click the **AM Push** integration.
5. Click the **Run Job – Sync All Data**  button.
6. When the Confirm synchronizing window appears, click **Yes**.
7. Click the **Refresh**  button and wait until the **Succeeded** message appears in the **Status** tab. The updated synchronization status appears.
8. From the left-hand navigation pane, select **Modeling > IT Universe Manager**.
9. Select the **Search CIs** tab .
10. In the CI type, select **Node** and click **Enter**.
11. Confirm that all CIs from AM appear in UCMDB.

# Chapter 5

---

## HP Asset Manager and HP Service Manager Via CIT Integration

This chapter includes:

Overview .....	40
Integrating AM with SM Via CIT .....	40
Verify AM to SM Configuration .....	41

### Overview

This chapter describes the necessary steps to configure and verify the integration between AM and SM via HP Connect-It (CIT).

### Integrating AM with SM Via CIT

1. Install **CIT 9.40**.
2. Download and unzip **SACM-9.30.zip**.
3. Browse to **C:\SACM-9.30**.
4. Select one of the following scenarios:
  - If the reference database for all PPT types is AM:
    - Use **amsm-ppt.scn** to transfer the PPTs from AM to SM.
    - Do not use **amsm-ci-ppt-link.scn** because links between CIs and Contact, Model, Vendor, Location and Department are managed by the **amsm-ppt.scn** scenario.
  - If the reference database for all PPT types is SM:
    - Use **smam-ppt.scn** to transfer the PPTs from AM to SM.
    - Use **smam-wo.scn** to transfer changes and tasks.
  - If the reference database for PPT types is a mixed solution between AM or SM according to PPT type:
    - Customize **smam-ppt.scn** so that PPTs referenced in SM are transferred to AM.
    - Customize **amsm-ppt.scn** so that PPTs referenced in AM are transferred to SM.
    - Do not use **amsm-ci-ppt-link.scn** because links between CIs and Contact, Model, Vendor, Location and Department are managed by the **amsm-ppt.scn** scenario.
    - Use **smam-wo.scn** to transfer changes and tasks.



5. For each scenario, define the AM details and SM details.
6. After all the details are defined in the components, click  to run the scenario.

## Verify AM to SM Configuration

1. Log on to SM and open a new change request.
2. Browse to **Changes > Open New Change**.
3. Enter all relevant data and mandatory fields.
4. Click **save**.
5. Log on to CIT.
6. Use the scenario **smam-wo.scn**.
7. Fill the relevant parameters for each product.
8. Click **Produce Now** .
9. Log on to AM.
10. Browse to **Asset Lifecycle > Work Orders > Work Orders**.
11. Confirm that AM received the change request .

# Chapter 6

---

## HP Asset Manager Web Configuration

This chapter includes:

Overview .....	42
Prerequisites .....	42
Implementing AM Automated Process Manager in Windows .....	42
Tomcat Configurations .....	43
AM Web Service package.properties Parameters .....	43
Update Archive File Using Deployment Script .....	44
Install AM Web Service .....	44
Test for AM Web Service Successful Deployment .....	45

### Overview

This section describes the necessary steps to configure and verify the AM Web Configuration.

### Prerequisites

1. Install JDK 6 and configure the environment variable of the JAVA\_HOME to JDK folder; for example, **C:\Program Files\Java\jdk1.6.0\_24**.
2. Install **Apache Tomcat 6.0.32**.
3. In order for some required libraries to be found by AM Web, make sure **<Asset Manager Installation folder>\bin** and **<Asset Manager Installation folder>\bin\x64** is in an environment variable of **Path**.

### Implementing AM Automated Process Manager in Windows

1. Browse to **Start > Run**.
2. Type **services.msc**.
3. Select **Asset Manager Automated Process Manager 9.3** and change the startup type to **automatic**.
4. Click **Start** and **OK**.

5. Browse to **Start > Programs > HP > Asset Manager 9.31 en > Automated Process Manager**.
6. Click **File connect to new database**.
7. Select the relevant database and type the credentials.

## Tomcat Configurations

**Note:** These configurations must to be done just for Tomcat 6.

1. Browse to **C:\Program Files\Apache Software Foundation\Tomcat 6.0\bin**.
2. Right click **tomcat6w.exe** and select **open**. The Apache Tomcat 6 Properties window appears.
3. Select the **Java** tab.
4. In the Java options window, insert the line - **Dsun.lang.ClassLoader.allowArraySyntax=true**.
5. Click **OK**.

## AM Web Service package.properties Parameters

**Note:** Before editing the property file, make sure to:

- Make a backup copy of the file.
- If your application server is started, stop it.

1. Browse to **<Asset Manager Installation folder>\websvc**.
2. Edit the parameters in the **package.properties** file.

Parameter	Description	Value
<b>DB.engine</b>	The database engine that is used by this installation of AM.	For example, <b>ORACLE</b>
<b>DB.datasource</b>	The name of the database server.	For example, <b>labm3amdb35</b>
<b>DB.login</b>	The database engine log on of AM schema.	
<b>DB.password</b>	The password of AM schema.	

Parameter	Description	Value
<b>DB.library.path</b>	The path to the aamapi93 library.	For example, <b>C:\Program Files\HP\Asset Manager9.30xx\bin\laamapi93.dll</b>
<b>AssetManager.UserLogin</b>	AM user logon to be used by the WebService.	For example, <b>Admin</b>
<b>AssetManager.UserPwd</b>	AM Password log on to be used by the WebService.	
<b>encrypt</b>	When this parameter is set to <b>true</b> , the user needs to enter a password in unencrypted format.	

## Update Archive File Using Deployment Script

1. Click **Start > Run**.
2. Type **cmd**.
3. Browse to **C:\Program Files\HP\Asset Manager 9.31 en\deploy**.
4. Type the command **deploy.bat ..\websvc\package.properties**.
5. Type the command **deploy.bat ..\webtier\ package.properties**.

## Install AM Web Service

1. Copy **<Asset Manager installation folder>\websvc\AssetManagerWebService.war** to **C:\Program Files\Apache Software Foundation\Tomcat6.0\webapps**.
2. Browse to **C:\Program Files\Apache Software Foundation\Tomcat 6.0\bin**.
3. Right click **tomcat6w.exe** and select **open**. The Apache Tomcat 6 Properties window appears.
4. Select the **Java** tab.
5. Insert the line **-Djava.library.path= C:\Program Files\HP\Asset Manager 9.31 en\bin**.
6. Start **Apache Tomcat 6**.

# Test for AM Web Service Successful Deployment

1. Open Internet Explorer.
2. Browse to **http://<Name of the Asset Manager Web Service server>:8080/AssetManagerWebService**.
3. Verify the following page appears:

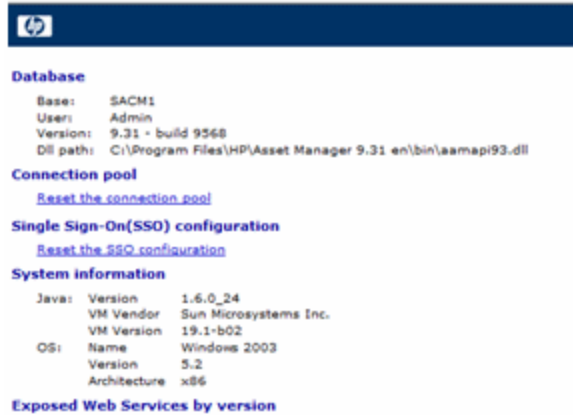

If an error message appears; for example:



1. Browse to **C:\Program Files\Apache Software Foundation\Tomcat 6.0\webapps\AssetManagerWebService\WEB-INF**.
2. Search for **AssetManager.DB.Name** and check that only the name of the AM schema is shown there.

```

<env-entry>
  <description>AssetManager Database name</description>
  <env-entry-name>AssetManager.DB.Name</env-entry-name>
  <env-entry-type>java.lang.String</env-entry-type>
  <env-entry-value>TEST</env-entry-value>
</env-entry>
    
```

# Chapter 7

---

## HP Service Manager and HP Asset Manager Integration

**This chapter includes:**

Overview .....	46
Integrating SM with AM Pursuant to Request from Catalog .....	46
Verify SM to AM Configuration .....	50

### Overview

This chapter describes the necessary steps to configure and verify the integration between SM and AM following a request from the catalog.

By default, the provided HP Connect-It scenarios transfer the same PPT types from AM to SM and from SM to AM. You cannot implement the scenarios as they are, because data replication would circle back and forth. Thus you must decide whether the AM or SM database will store the reference data for each of the PPT types:

- Companies
- Vendors
- Locations
- Departments
- Contacts
- Models
- Stock rooms

### Integrating SM with AM Pursuant to Request from Catalog

1. Run an SM client.
2. Connect to the SM database.
3. In the browser, select **Menus-Service Catalog-Approval Activities**.
4. Select the first line of the **General Approval** table.
5. Click the **Remove Approval Activity** link.
6. Click **Finish**.

7. Select **Menu Navigation-Tailoring-Database Dictionary** in the navigation pane.
8. Enter **svcDisplay** in the File name field.
9. Select the descriptor entry in the table (first line of the table).
10. Click the **New Field/Key** button.
11. Populate the Name field with the optionList value, the Type field with the character value, and click **OK**.
12. Edit the optionList entry in the table to populate the SQL Name field with **OPTIONLIST**, SQL Type with **IMAGE**, and SQL Table with **m1**.
13. Click **OK**.
14. Click **SM Alters**.
15. Select the descriptor entry in the table (first line of the table) again.
16. Click the **New Field/Key** button.
17. Populate the Name field with the optionOptions value, the Type field with the character value, and click **OK**.
18. Edit the optionOptions entry in the table to populate the SQL Name field with **OPTIONOPTIONS**, SQL Type with **IMAGE**, and SQL Table with **m1**.
19. Click **OK**.
20. Click **SM Alters**.
21. Select **Menu Navigation – Tailoring- Database Manager** in the navigation pane.
22. Right click the **Database Manager** screen and select **Import/Load** in the contextual menu.
23. In the File Name field, select the **<Asset Manager Installation folder>\lesscat\sc\sm71\SCR42940.unl** file.
24. Click the **Load FG** button.
25. Right click the **Database Manager** screen and select **Import/Load** in the contextual menu.
26. In the File Name field, select the **<Asset Manager Installation folder>\lesscat\sc\sm71\QC8955.unl** file.
27. Click the **Load FG** button.
28. Select **Tailoring- Web Services- WSDL Configuration** from the navigation bar.
29. In the Service Name field, enter **ServiceCatalog**.
30. Click **Search**.
31. Select the ServiceCatalog entry in the list of results.
32. In the details of the ServiceCatalogWeb service, select the **Fields** tab.
33. At the end of the list of fields, add a new entry with the following information:
  - Field: **detailedDescription**
  - Caption: **DetailedDesc**

- Type: **StringType**
34. Click **Save** and **OK**.
  35. In the Service Name field, enter **ServiceDesk**.
  36. Click **Search**.
  37. Select the ServiceDesk entry in the list of results.
  38. In the details of the ServiceDeskWeb service, select the **Fields** tab.
  39. At the end of the list of fields, modify the resolution field with the following information:
    - Caption: **Resolution**
    - Type: **StringType**
  40. In the same list, modify the resolution.code field with the following information:
    - Caption: **ResolutionCode**
  41. Connect to CIT.
  42. Click **File – open**.
  43. Browse to **<HP Connect-It installation folder>\scenario\ac\ac93\esscatl**.
  44. Run the follow scenarios:
    - **users.scn**
    - **sso.scn**
    - **categories.scn**
    - **catalogitems.scn**
    - **status.scn**
  45. In the Scenario diagram window, modify the configuration of the SM Web Service connectors:
    - a. Right-click the **SM Web Service connector(s)** and select **Configure connector....** The Configure the connector wizard opens.
    - b. Click **Next**.
    - c. Populate the **Define the connection parameters** page.
    - d. Click **Finish**.
  46. Return to the Scenario diagram window and modify the configuration of the AM connector:
    - a. Right-click the **AM connector** and select **Configure connector....**
    - b. Click **Next**.
    - c. Populate the Define the connection parameters page.
    - d. Click **Finish**.
  47. Save your changes (**File/ Save** menu).
  48. Install [apache-tomcat-6.0.35-windows](#).



49. Change the name of the folder to TomcatESS.
50. Browse to **C:\TomcatESS\conf\server.xml**.
51. Change the port to a different port of AssetManagerWebService; for example: **7080**.

```
<Connector port="7080" protocol="HTTP/1.1"
           connectionTimeout="20000"
           redirectPort="8443" />
```

52. Deploy the ServiceCatalog.war to **C:\TomcatESS\webapps**.
53. Log on to SM.
54. Browse to Service Catalog/ Catalog Connectors menu.
55. Select the connector named **Open a Standard Request** in AM.
56. On the Expressions tab, enter the hostname and port for the Esscat Web service.
57. Start the Tomcat configuration console (**Start/Programs/Apache Tomcat 5.0/ Configure TomcatWindows** menu).
58. Select the **Java** tab.
59. Add the following line to the Java Options section:
  - **-XX:MaxPermSize=256m**
60. Quit the Tomcat configuration console.
61. Browse to **Tailoring/Web Services/Run WSDL to JS** in the system navigator panel.
62. Enter the URL for the WSDL of the AM Web Service proxy. The format is:  
**http://ProxyServer:8080/Service Catalog/wsd/ServiceCatalog.wsdI**
63. Click **Proceed**. A window with the new Java script corresponding to the Web Service Proxy is displayed.
64. Click **Replace**. The following message appears:  
**Successful compilation of JavaScript function or expression.**
65. Enter **status** in a SM command prompt.
66. Check that linker appears in the list.
67. If the linker scheduler already appears in the list, restart it:
  - a. In the Command column of the linker line, enter **K**.
  - b. Click the **Execute Commands** button.
  - c. Repeat this action until the linker line disappears.
  - d. Click the **Start Scheduler** button.
  - e. Double-click linker-startup in the list.

## Verify SM to AM Configuration

1. Connect to SM with the following link: **http://hostname of SM:8080/webtier-9.30/ess.do**
2. Log on to SM with the user that you created in AM.
3. Click **order from catalog** from the left pane.
4. Choose the product that appears in the SM catalog.
5. Click **Add to cart**.
6. Click the **Checkout** link.
7. Click **submit request**.
8. Complete the purpose tab and select the Urgency.
9. Click **Submit** and **OK**.
10. Log on to AM.
11. Browse to **Asset Lifecycle – Procurement Lifecycle – Requests – purchase requests**.
12. Find the request in the list. It should begin with **ESS-SD XXX**.

# Chapter 8

---

## CI's Reconciliation Priority Best Practices

This chapter includes:

Overview .....	51
Priorities Logic .....	51
CI Reconciliation Priority .....	52

### Overview

In the SACM Solution, as well as from the ITPS Suite perspective, UCMDB is the center CI repository. As such, it is populated with CI information from various HP and third-party products. Therefore, UCMDB must decide which source is more reliable and which source has the most accurate information.

UCMDB uses internal out-of-the-box reconciliation rules that make sure no duplications are created and the CI information is accurate. In addition, it also uses the Reconciliation Priority module that gives the Configuration Manager the power to determine for UCMDB which integration points are more reliable for which CI Types or Attributes (for more information, see Chapter 10 Reconciliation Priority in the *HP UCMDB Data Flow Management Guide*).

In the SACM Solution, UCMDB is populated with CI information from two products – AM and SM.

This chapter details the Best Practice guidelines and configuration instructions for how to prioritize the information received from AM and SM into UCMDB in order for your UCMDB to contain the most accurate CI information.

### Priorities Logic

Consider the following when building the priorities detailed in the following CI Reconciliation Priority Mapping table:

- UCMDB DDMA discovery reflects reality by its capability and is the most reliable source of information for discoverable CITs.
- Business services and applications information is most likely to be more accurate in SM as the owner of the Service Catalog.
- There are CITs that are coming from AM or SM—but not both. Thus, if it is a discoverable CIT, DDMA will get the highest priority, and AM or SM will get the lower priority. Otherwise, the relevant product will get the priority. For example, for the Asset CIT, AM gets the highest priority.

**Note:** The following table of priorities is based only on CITs and Attributes that are supported by the Out-of-the-Box (OOTB) population integration.

The CI Reconciliation Priority Mapping table maps the various CITs and attributes between the three products—UCMDB, AM, and SM. The table also contains the necessary values to be defined for each integration point using the following instructions.

UCMDB CI / Attribute	Data Sources in the other products		Reconciliation Priority		
	AM	SM	Discovery	AM	SM
/Asset	deviceAsset	N/A	100	300	
asset_tag	AssetTag				
/ConfigurationItem/BusinessElement/Service/BusinessService	N/A	Business Service/ Business Service	100		200
name		CiIdentifier			
/ConfigurationItem/BusinessElement/BusinessApplication	N/A	Business Service/ Application Service	100		200
name		CiIdentifier			
/ConfigurationItem/BusinessElement/Service/InfrastructureService	N/A	Business Service/ Infrastructure Service	100		200
name		CiIdentifier			
/ConfigurationItem/InfrastructureElement/Location	amLocation	N/A	100	200	
name	Name				
location_type	LocationType				
/ConfigurationItem/InfrastructureElement/Node	host	Computer	300	100	100
name	TcpIpHostName	N/A			
serial_number	AssetSerialNo	SerialNo	300	200	100
bios_serial_number	N/A	BIOSId			
discovered_os_name	OperatingSystem	OS			
discovered_os_version	OSServiceLevel	OSVersion			
memory_size	IMemorySizeMb	PhysicalMemory			
discovered_vendor	N/A	Vendor	300		200
node_role	ComputerType	Ci-SubType			
/ConfigurationItem/InfrastructureElement/NetworkEntity/IpAddress	amNetworkCard	Computer/addIPAddr	300	100	100
ip_isdhcp	bDHCPEnabled	N/A			
ip_address	TcpIpAddress	N/A			
ip_address_value	ip_address_value	N/A			
ip_address_property	ip_address_property	N/A			
name	TcpIpAddress	AddIPAddress			
ip_netmask	SubnetMask	AddSubnet			
/ConfigurationItem/InfrastructureElement/NodeElement/Interface	amNetworkCard	Computer/AddMacAddress	300	100	100
mac_address	PhysAddress	AddIMacAddress			
name	N/A	AddIMacAddress			
/ConfigurationItem/InfrastructureElement/NodeElement/CPU	N/A	Computer/CPU	300	100	100
name		CpuName			
cpu_id		CpuID			
cpu_clock_speed		CpuClockSpeed			
/ConfigurationItem/InfrastructureElement/NodeElement/DiskDevice	N/A	Computer/disk.device	300	100	100
name		DiskName			
model_name		ModelName			
vendor		DiskVendor			
/ConfigurationItem/InfrastructureElement/NodeElement/FileSystem	N/A	Computer/file.system	300	100	100
disk_size		DiskSize			
mount_point		MountPoint			
filesystem_type		FilesystemType			
disk_type		DiskType			
/ConfigurationItem/InfrastructureElement/RunningSoftware	N/A	Running Software (???)	300		200
discovered_product_name		CiIdentifier			
product_name		ApplicationName			
application_version		ProductVersion			
vendor		Vendor			
version		Version			

## CI Reconciliation Priority

One of the challenges of managing an asset in its lifecycle phase as an active CI is to have as much information on it as possible collected from various systems—in addition to Discovery (such as business-related information)—but at the same time prevent duplication in the CMS system and, most importantly, keep the data's integrity. For these reasons, UCMDB holds the reconciliation capability and, in addition, allows the Configuration Manager to set priorities for the various sources of CIs.

In the SACM Solution, we have three sources – AM, SM and DDM. As part of the Solution's assets, there are Best Practices guidelines on how to set the Reconciliation Priority between AM, SM and DDM.

#### To configure CI Reconciliation Priority

1. Log on to UCMDB as an administrator.
2. From the left-hand navigation pane, select **Data Flow Management > Reconciliation Priority**.
3. In the CI Types pane, in the **Managed Object** tree, select the relevant CI type.
4. In the CI Type Overrides pane, select the integration name you wish to change the priority value for and click the **Priority** field to modify the value.

Repeat this step for every Integration Name you wish to change the Priority value for.

5. When the changes for the CI types are complete, click the **Save**  button in the CI Types pane.

#### To set the priority for a specific attribute for a particular CI type:

1. Select the relevant integration name in the CI Type Overrides pane.
2. In the Attribute Overrides pane, click the **Add**  button. The Add Attribute dialog box is displayed.
3. Select the relevant Attribute from list and click **OK**. The selected CI Attribute appears in Attribute Overrides pane.
4. Modify the **Priority** value.

**Note:** If you add the wrong attribute to the list, use the **Reset Attribute**  button to reset the Attribute Overrides list. Be aware this action clears all values in the **Attribute Overrides** list.

5. When finished with the changes to that CI type, click the **Save**  button in the CI Types pane.

# Appendix A

---

## Technical Reference

**This Appendix includes:**

Overview .....	54
HP Asset Manager > HP Universal CMDB .....	54
HP Service Manager <-> HP Asset Manager .....	70
HP Service Manager > HP Universal CMDB .....	80

## Overview

This appendix explains, for each database involved in the SACM integration, which data objects are sourced and mapped by which scenario or adapter, as well as the reconciliation keys used and any special requirements needed for data transfers to work properly.

## HP Asset Manager > HP Universal CMDB

**This section includes:**

What CI data are populated from AM to UCMDB? .....	55
What is created in UCMDB during population? .....	59
Reconciliation .....	60
What happens when changes occur in AM during data population? .....	60
Supported CI Types .....	60
Supported CI attributes and the mapping with the AM fields .....	61
The configuration files used by the integration .....	66

## What CI data are populated from AM to UCMDB?

This section includes:

Population TQLs .....	55
Criteria for AM records to be propagated .....	56

### Population TQLs

The types of CIs that can be propagated from AM to UCMDB are defined by the following TQLs included in the integration package.

- **locationDataImport\_930**  
This query is used to populate location data from AM.
- **hostImport\_930**  
This query is used to populate computer data from AM.
- **networkImport\_930**  
This query is used to populate network data from AM.
- **printerImport\_930**  
This query is used to populate printer data from AM.
- **businessElementDataImport\_930**  
This query is used to populate business service assets from AM.
- **businessElementRelationsImport\_930**  
This query is used to build relations between business service assets.

**Note:** For actual steps required to populate CI data, refer to [Creating an integration point between AM and UCMDB](#) [for details, see "[Step 5: Create integration point](#)" on page 34] and [Running population jobs](#) [for details, see "[Verify UCMDB to AM Configuration](#)" on page 35]. Also make sure that you have configured data population and federation as instructed in Chapter 3 "[Populating HP Universal CMDB from HP Asset Manager](#)" on page 32].

**To access these TQLs:**

1. Open a browser and connect to the UCMDB Server.
2. Click the **Modeling** tab.
3. Select **Modeling Studio**.
4. Click the **Resources** tab, and select **Queries** from the **Resource Type** drop-down list.
5. Expand the **Root/Integration/AM Data In** menu. The TQLs located under the path are used to manage CI data synchronization from AM to UCMDB. They have the same structure but manage different type of CI data.

## Criteria for AM records to be propagated

### Step 1: Node CIs

Node CIs in UCMDB correspond to records in the **amComputer** table in AM.

Out-of-the-box, the **amComputer** records need to satisfy the following conditions to be propagated to UCMDB as Node CIs:

- The status for the **Portfolio Item** linked to the **amComputer** record is in use or in stock (**amPortfolio:seAssignment = In use or In stock**).

This can be configured by modifying a configuration file (see "[condition\\_rules.xml](#)" on page 68).

- The **amComputer:ComputerType** field of the **amComputer** record must have a value that is present in the third column of the following table.



Relationship between TQL, CI Types, and computer types

**Note:** The path populates CIs of these CI Types to UCMDB under **Managed Objects/ConfigurationItem/ InfrastructureElement/Node/**

This TQL	Populates CIs of these CI Types to UCMDB	The CI Type corresponds to these computer types in AM ( <i>amComputer:ComputerType</i> )
hostDataImport_930	Computer	Computer
		Desktop computers
		Computer servers
		Laptop
		Virtual Machine
	Computer\Windows	Windows computer
		Windows desktop computer
		VMware VirtualCenter
		VMware ESX Server
	Computer\Unix	Unix server computer
		Unix desktop computer
		Solaris Zone server
	Computer\Mainframe	Mainframe Storage Array Mainframe CPC <b>Note:</b> Storage Array is not a computer type value. By default, AM will handle those records where <b>amNature.Name</b> is Storage Provider as <b>Storage Array</b> .
networkDataImport_930	Net Device\Firewall	Firewall
	Net Device Router	Router
	Net Device Switch	Switch

This TQL	Populates CIs of these CI Types to UCMDB	The CI Type corresponds to these computer types in AM ( <i>amComputer:ComputerType</i> )
networkDataImport_930	Net Device\ATM Switch  <b>Node:</b> ADSL Modem Appletalk Gateway Bandwidth Manager Cable modem CSU_DSU Ethernet FDDI HUB KVM Switch Load Balancer Multicast Enabled Router NAT Router Token Ring Undefined Network Component VoIP Gateway VoIP Switch VPN Gateway Wireless Access Point, Frame_relay_switch San_gateway San_router San_switch Pad_handhel	ATM switch
printerDataImport_930	Net Device\Net Printer	Network printer

**Note:** In addition to the Node CIs, each of the TQLs also populates information (if exists) such as IP address, interface, and locations from AM to UCMDB.

- The mapping between CI Type and computer type (value of the **amComputer:ComputerType** field) is defined in the **discriminator.properties** file (see "[discriminator.properties](#)" on page 66).

## Step 2: Business Element

In AM, only those business service asset whose status (**amAsset.Status**) in the list of **built**, **catalogued**, **chartered**, **designed** and **requested** will be populated to UCMDB. If the status is **retired**, it will be removed from UCMDB.

Relationship between AM business service asset and CI types:

Nature code	CI Type
BIZSVC	business_service
BIZAPP	business_application
INFRASVC	infrastructure_service

## What is created in UCMDB during population?

When an **amComputer** record (with the associated information) is populated from AM to UCMDB:

- A Node CI is created in UCMDB.
  - Its CI Type depends on the value of the **amComputer:ComputerType** field.
    - Relationship between TQL, CI Types, and computer types (see "[What CI data are populated from AM to UCMDB?](#)" on page 55)
- For each Networkcard record (**amComputer:NetworkCards**) attached to the AM Node CI, two CIs are created in UCMDB: **IP address** and **Interface**.

The values of the following AM **amNetworkCard** table field are used to create the IP Address and Interface CIs:

- **amNetworkCard:TcplpAddress**, together with other field values, is used to create an IP Address CI.
- **amNetworkCard:PhysAddress**, together with other field values, is used to create an Interface CI.
- If the AM **amComputer** data has an associated location which is comprised of several layers, then one Location CI is created for each layer of location.

For example, in AM one computer has a location of **/Ariane Building/31st Floor/030 – Office/**, then when the Node CI for the computer is populated to UCMDB, 3 location CIs are created for each layer in the location, representing the building, floor and room respectively.

**Note:** The layers of location in AM should be less than the layer defined in the TQL, which by default is 3. Otherwise, you need to add elements to the corresponding TQL to support it.

## Reconciliation

For each CI Type, the data reconciliation is governed by the reconciliation rule set in UCMDB.

You can check the reconciliation rule for each CI Type on the **Details** tab of the CI Type. The field name is **Identification**.

## What happens when changes occur in AM during data population?

- If the value of the **amPortfolio:seAssignment** field has been changed to a value not present in `condition.rules.xml` (see "`condition_rules.xml`" on page 68), the corresponding CI is deleted from UCMDB with the associated IPAddress CIs (if exists).
- However, if the IT equipment record is deleted from AM, the previously populated CI remains in UCMDB.

## Supported CI Types

**To find out the CI Types supported by the AM adapter out-of-the-box:**

1. Start UCMDB Server.
2. Open a browser and connect to UCMDB Server as administrator.
3. From the left navigation bar, click the **Data Flow Management** tab.
4. Click **Integration Studio**.
5. Select the integration point created for AM.
6. Select the **Federation** tab on the right pane. The supported CI Types are shown in the

**Supported and Selected CI Types** section. You can click **Expand all**  in the toolbar to view all CI Types at a glance.

**Note:**

- Most CI Types supported by the integration are UDM compliant, except for **Printer** and those CI Types under Node.
- Those grayed CI Types are not supported.
- If a CI Type is supported, all its children CI Types are automatically supported.

## Supported CI attributes and the mapping with the AM fields

For each CI Type supported by the integration, below are the mappings between the UCMDB CI attribute and AM field. For each CI attribute, its compliance with BTO Data Model (UDM) 1.1 is also identified.

**This section includes:**

CI Type: Asset .....	61
CI Type: IPAddress .....	61
CI Type: Node .....	62
CI Type: CPU .....	63
CI Type: DiskDevice .....	63
CI Type: FileSystem .....	63
CI Type: InstalledSoftware .....	64
CI Type: Interface .....	64
CI Type: LogicalVolume .....	64
CI Type: Printer .....	65
CI Type: Location .....	65
CI Type: BusinessElement .....	65

### CI Type: Asset

UCMDB attribute	AM field	UDM entity?
asset_tag	amPortfolio.asset_tag	Yes
description	amAsset.AssetSerialNo	Yes
id1	amPortfolio.IPortfolioItemId	No
assignment	amPortfolio.seAssignment	Yes

### CI Type: IPAddress

UCMDB attribute	AM field	UDM entity?
id1	amNetworkCard.INetworkCardId	No
ip_address	amNetworkCard.TcpIpAddress	No

UCMDB attribute	AM field	UDM entity?
ip_address_property	View_amNetworkCard.ip_address_property	Yes
ip_address_value	View_amNetworkCard.ip_address_value	Yes
ip_dhcpdomainname	amNetworkCard.DHCPServer	No
ip_isdhcp	amNetworkCard.BDHCPEnabled	No
ip_netmask	amNetworkCard.SubnetMask	No
name	amNetworkCard.TcpIpAddress	Yes

## CI Type: Node

All the children CIs of the Node CI inherit the same attribute from the Node CI. In particular these CI Types are relevant with the integration:

- Computer
- Windows
- Unix
- Mainframe
- Firewall
- Router
- Switch
- ATM Switch
- Net Printer

UCMDB attribute	AM field	UDM entity?
asset_tag	amPortfolio.AssetTag	Yes
create_time	amPortfolio.dtRecCreation	Yes
data_externalid	amComputer.IComputerId	No
data_note	amPortfolio.seAssignment	No
default_gateway_ip_address	amNetworkCard.DefaultGateway	Yes
description	amAsset.Description	Yes
discovered_os_name	amComputer.OperatingSystem	Yes
discovered_os_version	amComputer.OSServiceLevel	Yes
host_isdesktop	amComputer.ComputerType	No

UCMDB attribute	AM field	UDM entity?
host_isvirtual	amComputer.ComputerType	No
id1	amComputer.ItemId	No
last_modified_time	amComputer.dtLastModif	Yes
memory_size	amComputer.IMemorySizeMb	Yes
name	amComputer.TcpIpHostName	Yes
node_model	amModel.ModelName	Yes
node_role	amComputer.ComputerType	Yes
primary_dns_name	amComputer.TcpIpDomain	Yes
serial_number	amAsset.SerialNo	Yes
globalid	amPortfolio.CMDBId	Yes

## CI Type: CPU

UCMDB attribute	AM field	UDM entity?
core_number	amComputer.ICPUCoreNumber	No
cpu_id	amComputer.IComputerId	Yes
cpu_speed	amComputer.ICPUSpeedMHz	No
id1	amComputer.ItemId	No
name	amComputer.Name	Yes
cpu_clock_speed	amComputer.ICPUSpeedMHz	Yes

## CI Type: DiskDevice

UCMDB attribute	AM field	UDM entity?
Id1	amPhysicalDrive.IPhysDriveId	No
name	amPhysicalDrive.Description	Yes

## CI Type: FileSystem

UCMDB attribute	AM field	UDM entity?
disk_size	amPhysicalDrive.ITotalSizeMb	No

UCMDB attribute	AM field	UDM entity?
Id1	amPhysicalDrive.IPhysDriveld	No
name	amPhysicalDrive.Description	Yes

## CI Type: InstalledSoftware

UCMDB attribute	AM field	UDM entity?
description	Model.comment.memComment	Yes
File_system_path	amSoftInstall.Folder	Yes
id1	amSoftInstall.ISoftInstld	No
Name	amModel.Name	Yes
Vendor	amBrand.Name	Yes
Version	amSoftInstall.VersionLevel	Yes

## CI Type: Interface

UCMDB attribute	AM field	UDM entity?
id1	amNetworkCard.INetworkCardId	No
interface_description	amNetworkCard.Description	Yes
mac_address	amNetworkCard.PhysAddress	Yes

## CI Type: LogicalVolume

UCMDB attribute	AM field	UDM entity?
id1	amLogicalDrive.ILogDriveld	No
logicalvolume_free	amLogicalDrive.IFreeSpaceMb	No
logicalvolume_fstype	amLogicalDrive.Media	No
logicalvolume_size	amLogicalDrive.ITotalSizeMb	No
Name	amLogicalDrive.MountPoint	Yes



## CI Type: Printer

UCMDB attribute	AM field	UDM entity?
id1	amPortfolio.IPortfolioItemId	No
name	amPortfolio.ModelName	Yes

## CI Type: Location

UCMDB attribute	AM field	UDM entity?
id1	amLocation.ILocalId	No
location_type	amLocation.LocationType	Yes
name	amLocation.FullName	Yes
Location_bar_code	amLocation.BarCode	Yes

## CI Type: BusinessElement

UCMDB attribute	AM field	UDM entity?
Id1	amPortfolio.IPortfolioItemId	No
Name	amAsset.AssetTag	Yes
last_modified_time	amPortfolio.dtLastModif	Yes
create_time	amPortfolio.dtRecCreation	Yes
description	amAsset.Description	Yes
data_note	amAsset.Status	No
global_id	amPortfolio.CMDBId	Yes

## The configuration files used by the integration

This section includes:

Where are the configuration files located ..... 66

### Where are the configuration files located

The configuration files that are relevant with the integration are located in the following path in UCMDB:

**Data Flow Management\Adapter Management\AMAdapter\Configuration Files**

This section includes:

discriminator.properties ..... 66  
 server\_desktop\_distinguisher.properties ..... 67  
 fixed\_values.txt ..... 68  
 location\_type\_transformer.xml ..... 68  
 condition\_rules.xml ..... 68  
 Global\_id\_mapping.properties ..... 70

### discriminator.properties

When a CI is populated to UCMDB, its CI Type is defined according to the value of **amComputer:ComputerType** in AM.

This file defines the mapping between the values of **amComputer:ComputerType** and the UCMDB CI Type.

A summary of the mapping can be found at the following location: "[What CI data are populated from AM to UCMDB?](#)" on page 55.

### server\_virtual\_distinguisher.properties

When a CI is populated to UCMDB, the **Host is Virtual** attribute of the CI is defined according to the value of **amComputer:ComputerType** for the CI in AM.

This file defines the mapping between the values of **amComputer:ComputerType** and the **Host is Virtual** attribute.

If the value of <i>amComputer:ComputerType</i> in AM is...	the value of <i>Host is Virtual</i> in UCMDB is...
Virtual Machine	Virtual Machine

If the value of <i>amComputer:ComputerType</i> in AM is...	the value of <i>Host is Virtual</i> in UCMDB is...
<ul style="list-style-type: none"> <li>• Windows computer</li> <li>• Windows desktop computer</li> <li>• VMware Virtual Center</li> <li>• VMware ESX server</li> <li>• Unix server computer</li> <li>• Unix desktop computer</li> <li>• Solaris Zone Server</li> <li>• Desktop computers</li> <li>• Computer servers</li> <li>• Laptop</li> <li>• Mainframe</li> <li>• ATM switch</li> <li>• Firewall</li> <li>• Router</li> <li>• Switch</li> <li>• Network printer</li> </ul>	No

### server\_desktop\_distinguisher.properties

When a CI is populated to UCMDB, the **Host is Desktop** attribute of the CI is defined according to the value of **amComputer:ComputerType** for the CI in AM.

This file defines the mapping between the values of **amComputer:ComputerType** and the **Host is Desktop** attribute.

If the value of <i>amComputer:ComputerType</i> in AM is...	the value of <i>Host is Desktop</i> in UCMDB is...
<ul style="list-style-type: none"> <li>• Windows desktop computer</li> <li>• Unix desktop computer</li> <li>• Desktop computers</li> </ul>	Yes

If the value of <i>amComputer:ComputerType</i> in AM is...	the value of <i>Host is Desktop</i> in UCMDB is...
<ul style="list-style-type: none"><li>• Windows computer</li><li>• VMware Virtual Center</li><li>• VMware ESX server</li><li>• Unix server computer</li><li>• Solaris Zone Server</li><li>• Computer servers</li><li>• Laptop</li><li>• Mainframe</li><li>• ATM switch</li><li>• Firewall</li><li>• Router</li><li>• Switch</li><li>• Network printer</li></ul>	No

## fixed\_values.txt

When populating IP address data from AM to UCMDB, the `IpAddress:routing_domain` attribute value of the IP Address CI Type is populated with `DefaultDomain`.

This file allows you to change the default value for the attribute.

## location\_type\_transformer.xml

This file contains all the mappings between location types in AM and UCMDB. Mapping for a location type is represented by an entry like this:

```
<value cmdb-value="room" external-db-value="room"/>
```

The UCMDB location type is the value for the `cmdb-value` attribute, while the AM location type is the value for the `external-db-value` attribute.

All the AM location types must be mapped with those in UCMDB for the data population to be successful.

## condition\_rules.xml

Out-of-the-box, this file defines the basic rules to decide what kind of CIs can be populated from AM to UCMDB and remove CIs from UCMDB.

Out-of-the-box, only **amComputer** records whose associated **Portfolio Item** is in stock (**amPortfolio:seAssignment = In stock**) can be populated to UCMDB as Node CIs.

This file allows you to customize the assignments (**amPortfolio:seAssignment**) computers could have for them to be populated.

This configuration file uses values stored in the AM database to designate the value of the **seAssignment** field. Refer to the following table for the relationship between the value stored in the database and the displayed value.

Value stored in the displayed	Actual displayed text for <i>seAssignment</i>
0	In use
1	In stock
2	Retired
3	Awaiting receipt
4	Return for maintenance
5	Return to supplier
6	Missing

You can designate multiple values in this file to allow populating computers with different assignments to UCMDB.

Find the statement:

```
<expression join="AND" field="data_note" data-type="INTEGER"
operator="IN" value="0,1"/>
```

This means it will only add/update those Node CIs whose **data\_note** (**amPortfolio.seAssignment**) is 0 (In use) or 1 (In stock).

Find the statement:

```
<expression join="NOT" field="data_note" data-type="INTEGER"
operator="IN" value="0,1"/>
```

This means it will only remove those Node CIs whose **data\_note** is not in the list of 0 and 1.

**Note:** Keep the same value for these two expressions.

This means that computers with the assignments (**amPortfolio:seAssignment**) **In use** and **In stock** can be populated to UCMDB. If you change their assignment to other values in AM, the corresponding CIs will be deleted when you run the population job next time (see ["What happens when changes occur in AM during data population?" on page 60](#)).

## Global\_id\_mapping.properties

Make sure **Push back ID** is enabled when creating the integration point. Define how to write global\_id back to AM. By default, **global\_id** is saved in the amPortfolio.CMDBId field.

# HP Service Manager <-> HP Asset Manager

This section includes:

Overview .....	70
What happens when a CI does not exist in SM .....	71
Reconciliation keys for amsm-ppt.scn .....	71
Reconciliation keys for amsm-ci-ppt-link.scn .....	74
Reconciliation keys for smam-ppt.scn .....	75
Reconciliation keys for smam-wo.scn .....	79

## Overview

Overview of the HP Asset Manager – HP Service Manager integration

Integration direction	From AM to SM	From SM to AM
Integration technology	HP Connect-It	HP Connect-It
Populated data	<ul style="list-style-type: none"> <li>• amsm-ppt.scn:                             <ul style="list-style-type: none"> <li>▪ Companies</li> <li>▪ Vendors</li> <li>▪ Locations</li> <li>▪ Departments</li> <li>▪ Contacts</li> <li>▪ Models</li> <li>▪ Stock rooms</li> <li>▪ Links between CIs and Contact, Model, Vendor, Location, Department</li> </ul> </li> <li>• amsm-ci-ppt-link.scn                             <ul style="list-style-type: none"> <li>▪ Links between CIs and Contact, Model, Vendor, Location, Department</li> </ul> </li> </ul>	<ul style="list-style-type: none"> <li>• smam-ppt.scn:                             <ul style="list-style-type: none"> <li>▪ Companies</li> <li>▪ Vendors</li> <li>▪ Locations</li> <li>▪ Departments</li> <li>▪ Contacts</li> <li>▪ Models</li> <li>▪ Stock rooms</li> </ul> </li> <li>• smam-wo.scn:                             <ul style="list-style-type: none"> <li>▪ Changes and tasks</li> </ul> </li> </ul>

Integration direction	From AM to SM	From SM to AM
HP Connect-It scenarios	<ul style="list-style-type: none"> <li>• amsm-ppt.scn</li> <li>• amsm-ci-pptlink.scn</li> </ul>	<ul style="list-style-type: none"> <li>• smam-ppt.scn</li> <li>• smam-wo.scn</li> </ul>

**Note:** These scenarios do not create CIs. CIs are created in AM directly or created in HP Discovery and Dependency Mapping Inventory and populated in AM.

AM CIs are populated/federated to UCMDB.

UCMDB CIs are populated to SM.

## What happens when a CI does not exist in SM

If a CI does not exist in SM yet when a PPT/CI link is presented, an AM output event is created by the HP Connect-It scenarios.

HP Connect-It will try and process the output events whenever the scenario is rerun.

Note that output events automatically expire according to the AM database options:

1. Start the AM Windows client and connect to the database.
2. Use the **Administration/ Database options...** menu.
3. Configure the **Event management/ Expiration time for output events (hours)** option.

## Reconciliation keys for amsm-ppt.scn

This section includes:

Companies .....	71
Vendors .....	72
Locations .....	72
Departments .....	73
Contacts .....	73
Models .....	74
Stock rooms .....	74

## Companies

Key in SM	AM value searched for in the SM key
company:customer.id	amCompany.Code

Only AM companies for which **amCompany.Qualif1 = Parent company** are replicated.

For languages other than English, the <HP Connect-It installation folder>\config\ac\strings\qualif.str file must be customized. The ID of the string to modify in this file is **AMQUALIF\_PARENT**. Replace **Parent** company with the right string for your language.

The AM `amCompany:Code` field must be populated.

## Vendors

Key in SM	AM value searched for in the SM key
vendor:vendor	amCompany.Name
AND vendor:location	amCompany.MainSite:Barcode

## Locations

Key in SM	AM value searched for in the SM key
location:location	amLocation.BarCode

The AM `amLocation.BarCode` field must be populated.



## Departments

Key in SM	AM value searched for in the SM key
dept:company + dept:dept	<p>amEmpIDept.Location.Company.Code Reconciliation uses the following rule:</p> <pre>RetVal = RemoveSlashAtExtremity([FullName]) If [Location.Company.Code] &lt;&gt; "" Then RetVal = [Location.Company.Code] &amp; "/" — &amp; RetVal End If</pre> <p><b>Example:</b></p> <p>In AM, we have four departments:</p> <ul style="list-style-type: none"> <li>• Department <b>NameA</b> FullName = /NameA/</li> <li>• Department <b>NameB</b> under <b>NameA</b> FullName = /NameA/NameB/</li> <li>• Department <b>NameC</b> under <b>NameB</b> FullName = /NameA/NameB/NameC/</li> <li>• Department <b>NameD</b> under <b>NameC</b> FullName = /NameA/NameB/NameC/NameD/</li> </ul> <p><b>NameD</b> is linked to a location linked to a company with <b>amCompany.Code = COMPANY_CODE SM.</b></p> <p>The key for <b>NameD</b> is <b>COMPANY_CODE/NameA/NameB/NameC/NameD.</b></p> <p>The key for <b>NameC</b> is <b>NameA/NameB/NameC.</b></p>

Only AM departments for which **amEmpIDept.bDepartment = 1** are replicated.

## Contacts

Key in SM	AM value searched for in the SM key
contacts:contact.name	amEmpIDept.Name, Name.FirstName (amEmpIDept.BarCode)

**Note:**

- **amEmpIDept:Name** can be up to 50 characters long, **Name:FirstName** up to 30 characters, and **amEmpIDept.BarCode** up to 255 characters long.
- **contacts.contact.name** can only store 140 characters.
- If the **amEmpIDept.BarCode** field does not exceed 55 characters, the reconciliation keys work fine.

## Models

Key in SM	AM value searched for in the SM key
model:part.no	amModels.BarCode

**Note:** The AM **amModels.BarCode** field must be populated.

## Stock rooms

Key in SM	AM value searched for in the SM key
stockroom:stockroom	amStock.Name

## Reconciliation keys for amsm-ci-ppt-link.scn

This section includes:

Links between device CIs and PPT objects .....	74
--	----

## Links between device CIs and PPT objects

Key in SM	AM value searched for in the SM key
device:asset.tag	amComputer.AssetTag
Devices are linked to the following objects: <ul style="list-style-type: none"> <li>• Contact</li> <li>• Model</li> <li>• Vendor</li> <li>• Location</li> <li>• Department</li> </ul>	The same keys are used as for the transfer of PPTs themselves. See tables above.

The AM **amComputer:AssetTag** field must be populated.

## Reconciliation keys for smam-ppt.scn

This section includes:

Locations and their link to a company and a country .....	75
Companies .....	75
SM Companies replicated as AM departments .....	76
Departments .....	76
Contacts .....	76
Operators .....	76
Vendors .....	77
SM vendor sites replicated as companies in AM .....	78
Stocks .....	78
Models .....	78

The smam-ppt.scn scenario uses the SACMIntegration web service.

### Locations and their link to a company and a country

Key in AM	SM value searched for in the AM key
amLocation.BarCode	location:location
amCompany.Code	location:company
amLocation.Country.Name	location:country

If no country can be found for which **amCompany:Code = location:country**, the location will be linked to a location with **amCompany:Code = Unknown country**.

Make sure the AM **amCompany:Code** field is populated.

Make sure the AM **amCountry:Name** field is populated with unique values.

smam-ppt.scn uses the **ScCountryToAc** map table in the catmod.mpt file to map SM countries to AM countries.

### Companies

Key in AM	SM value searched for in the AM key
amCompany.Code	company:CompanyCode
amCompany.MainSite.Name	company:CompanyCode
amCompany.Sites.Name	company:CompanyCode

Make sure the AM **amCompany.CompanyCode** field is populated with unique values.

Make sure the AM **amCompany.Code** field is populated.

## SM Companies replicated as AM departments

Key in AM	SM value searched for in the AM key
amEmpIDept.BarCode	company:CompanyCode
amEmpIDept.Location.FullName	company:CompanyCode

Make sure the SM **amCompany.CompanyCode** field is populated with unique values.

**amEmpIDept.bDepartment** is set to 1.

## Departments

Key in AM	SM value searched for in the AM key
amEmpIDept.FullName	dept:dept.structure

**amEmpIDept.bDepartment** is set to 1.

A function converts **dept:dept.structure** to **amEmpIDept.FullName**.

## Contacts

Key in AM	SM value searched for in the AM key
amEmpIDept.BarCode	contacts:contactname
amEmpIDept.Location.BarCode	contacts:location
amEmpIDept.Parent.FullName	contacts:dept

Make sure the SM **contacts.locationcode** field is populated with unique values.

## Operators

Key in AM	SM value searched for in the AM key
amEmpIDept.BarCode	operator:name
amEmpIDept.WorkUnit.Description	operator:name
amEmpIDept.WorkUnit.Model.Name	The scenario links the employee to the model for which amModel.Name = Hourly rate

Operators is an extension of the contacts table.

After contacts have been imported, operators are imported to populate **amEmpIDept.WorkUnit**.

A model is created in AM with **amModel.Name = Hourly rate**.

This model is linked to a nature (which must pre-exist) with **amNature.Code = TCO\_WORK\_UNIT** and also linked to a parent model which **amModel.Name = Work** unit and which will be created if it does not exist.

The parent model must also be linked to a similar nature.

This must be created by hand or can be retrieved through the import of **Financials – Line-of-business data (TCO-budgets-chargeback)**.

## Vendors

Key in AM	SM value searched for in the AM key
amCompany.Name	vendor:vendor
amCompany.MainSite.FullName	<b>vendor:vendor.id + vendor:vendor.location</b>
amCompany.MainSite.Country.Name	vendor:country
amCompany.Contact.FirstName + amCompany.Contact.Name	<ul style="list-style-type: none"> <li>• vendor:contract.person</li> <li>• vendor:order.person</li> <li>• vendor:sales.mgr</li> <li>• vendor:service</li> </ul>

Make sure **vendor:contract.person**, **vendor:order.person**, **vendor:sales.mgr** and **vendor:service** use the <Last name>, <First name> format.

This is split into **amCompany.Contact.FirstName** and **amCompany.Contact.Name** in AM.

Make sure the SM **vendor:vendor** field is populated with unique values. If two different SM vendors have the same value for the **vendor:vendor** field in SM in different locations, only the first vendor is imported to AM.

Make sure the SM **vendor:vendor.location + vendor:vendor.id** fields are populated with unique values. If two SM vendors have the same value for the **vendor:vendor.location** field and for the **vendor:vendor.id** field although they are linked to different locations (address differs), the two vendors will be linked to the same location (the first that was transferred to AM)

Make sure the AM **amCountry.Name** field is populated with unique values.

The HP Connect-It scenario uses the **SccountryToAc** map table in the catmod.mpt file to map **amCountry.Name**.

## SM vendor sites replicated as companies in AM

Key in AM	SM value searched for in the AM key
amLocation.FullName	<b>vendor:vendor.id + vendor:location</b> are used to create a full name
amLocation.Company.Name	vendor:vendor

Make sure the SM **vendor:vendor.id + vendor:location** fields are populated with unique values. If two SM vendors have the same value for the **vendor:vendor.id + vendor:location** fields although they are linked to different locations (address differs), the two vendors locations will result in a single location in AM (the first that was transferred to AM)

When vendors were created (see "[Vendors](#)" on previous page), if two different SM vendors have the same value for the **vendor:vendor** field in SM in different locations, only the first vendor is imported to AM. So when the location created by this mapping is linked to a company, it may be associated to the wrong company.

## Stocks

Key in AM	SM value searched for in the AM key
amStocks.Name	stockRoom:stockroom
amStock.Supervisor.BarCode	stockRoom:manager
amStock.DelivLocation.Field1	location:location

## Models

Key in AM	SM value searched for in the AM key
amModel.BarCode	model:part.no
amModel.Brand.Name + amModel.Brand.Company.Name	model:manufacturer
amModel.Nature.Code	model:Category
amModel.Parent.BarCode	model:Category

Key in AM	SM value searched for in the AM key
amModel.Photo	<pre> if [Retrieve- SACMMo- delResponse.model.instance.attachments.attachment (0).name] = "" then RetVal = [RetrieveSACMModelResponse.model.instance.Model] + "_" + [RetrieveSAC MModelResponse.model.instance.PartNumber] else RetVal = "SM_" &amp; [RetrieveSACMModelResp onse.model.instance.attachments.attachment(0).name] end if                     </pre>

**amModel.Nature.Code** is mapped using the **ScToAcNature** map table located in <HP Connect-It installation folder>\scenario\ac\ac53\sacm\mpt\catmod.mpt.

The natures listed in the **ScToAcNature** map table must exist in the AM database.

A model is not created in AM unless at least one of following is populated in SM: **model:Model**, **model:PartNumber**, **model:Category**.

## Reconciliation keys for smam-wo.scn

This section includes:

Changes > Workorders .....	79
Tasks > Workorders .....	79
For the corresponding CI .....	80

This scenario propagates details of unplanned changes and tasks from SM to AM as Work Orders.

The relevant links between CIs and PPT data are propagated from AM to SM by another HP Connect-It scenario.

### Changes > Workorders

Key in AM	SM value searched for in the AM key
amWorkOrder.WoNo	cm3r:header.number

### Tasks > Workorders

Key in AM	SM value searched for in the AM key
amWorkOrder.WoNo	cm3t:header.number

## For the corresponding CI

Key in AM	SM value searched for in the AM key
amComputer.AssetTag	device:logical.name

## HP Service Manager > HP Universal CMDB

This section explains how SM retrieves actual state information about CIs.

Displaying the actual state of CIs is a standard SM feature.

The actual state reflects the real attributes of a CI. Most of the time, these attributes will be retrieved through AM, and then populated/federated to UCMDB.

To retrieve actual state data, SM calls a UCMDB Web service. This Web service calls TQLs. The TQLs retrieve AM data through federation and replication.