

HP Universal CMDB

for the Windows and Solaris operating systems

Software Version: 8.03

Model Management

Document Release Date: September 2009

Software Release Date: September 2009



Legal Notices

Warranty

The only warranties for HP products and services are set forth in the express warranty statements accompanying such products and services. Nothing herein should be construed as constituting an additional warranty. HP shall not be liable for technical or editorial errors or omissions contained herein.

The information contained herein is subject to change without notice.

Restricted Rights Legend

Confidential computer software. Valid license from HP required for possession, use or copying. Consistent with FAR 12.211 and 12.212, Commercial Computer Software, Computer Software Documentation, and Technical Data for Commercial Items are licensed to the U.S. Government under vendor's standard commercial license.

Copyright Notices

© Copyright 2005 - 2009 Hewlett-Packard Development Company, L.P.

Trademark Notices

Adobe® and Acrobat® are trademarks of Adobe Systems Incorporated.

Intel®, Pentium®, and Intel® Xeon™ are trademarks of Intel Corporation in the U.S. and other countries.

Java™ is a US trademark of Sun Microsystems, Inc.

Microsoft®, Windows®, Windows NT®, and Windows® XP are U.S registered trademarks of Microsoft Corporation.

Oracle® is a registered US trademark of Oracle Corporation, Redwood City, California.

Unix® is a registered trademark of The Open Group.

Documentation Updates

The title page of this document contains the following identifying information:

- Software Version number, which indicates the software version.
- Document Release Date, which changes each time the document is updated.
- Software Release Date, which indicates the release date of this version of the software.

To check for recent updates, or to verify that you are using the most recent edition of a document, go to:

<http://h20230.www2.hp.com/selfsolve/manuals>

This site requires that you register for an HP Passport and sign-in. To register for an HP Passport ID, go to:

<http://h20229.www2.hp.com/passport-registration.html>

Or click the **New users - please register** link on the HP Passport login page.

You will also receive updated or new editions if you subscribe to the appropriate product support service. Contact your HP sales representative for details.

Support

Visit the HP Software Support web site at:

<http://www.hp.com/go/hpsoftwaresupport>

This web site provides contact information and details about the products, services, and support that HP Software offers.

HP Software online support provides customer self-solve capabilities. It provides a fast and efficient way to access interactive technical support tools needed to manage your business. As a valued support customer, you can benefit by using the support web site to:

- Search for knowledge documents of interest
- Submit and track support cases and enhancement requests
- Download software patches
- Manage support contracts
- Look up HP support contacts
- Review information about available services
- Enter into discussions with other software customers
- Research and register for software training

Most of the support areas require that you register as an HP Passport user and sign in. Many also require a support contract. To register for an HP Passport ID, go to:

<http://h20229.www2.hp.com/passport-registration.html>

To find more information about access levels, go to:

http://h20230.www2.hp.com/new_access_levels.jsp

Table of Contents

| | |
|------------------------------------|-----------|
| Welcome to This Guide | 13 |
| How This Guide Is Organized | 13 |
| Who Should Read This Guide | 14 |
| Getting More Information | 15 |

PART I: MODELING

| | |
|---|-----------|
| Chapter 1: Configuration Management Database (CMDB)..... | 19 |
| CMDB Overview | 19 |
| Configuration Items (CI)..... | 21 |
| Nodes and Relationships | 21 |
| CMDB Log Files | 21 |
| Log Severity Levels | 30 |
| Chapter 2: IT Universe Manager | 33 |
| IT Universe Manager Overview | 34 |
| Working with Views in IT Universe Manager..... | 35 |
| View Tree Structure | 36 |
| Working with CIs | 37 |
| Working with Relationships..... | 41 |
| Create CIs and Relationships in the CMDB..... | 45 |
| Check Status of Application Discovery (Rediscover a View) | 46 |
| IT Universe Manager User Interface..... | 49 |
| Chapter 3: Modeling Studio..... | 85 |
| Modeling Studio – Overview | 86 |
| Business CI Models | 86 |
| Building a Perspective Based View | 88 |
| Revealed CIs and Watchpoints | 90 |
| Build a Business CI Model | 94 |
| Build a View Based on a Model | 96 |
| Build a View Based on a Collection of CIs..... | 96 |
| Modeling Studio User Interface..... | 97 |

| | |
|--|------------|
| Chapter 4: View Manager | 129 |
| View Manager Overview | 130 |
| View Formats..... | 130 |
| Templates and Perspectives..... | 131 |
| Predefined Folders and Views | 132 |
| Building a Business View..... | 133 |
| Link Nodes to Application CI | 134 |
| Grouping By Attribute Properties..... | 137 |
| Merge Identical Instances..... | 138 |
| Create a Parameterized Template | 139 |
| Create a Perspective | 141 |
| Create a Template Based View | 142 |
| Create a Pattern View | 144 |
| View Manager User Interface | 145 |
| Troubleshooting and Limitations | 175 |
| Chapter 5: Correlation Manager | 177 |
| Correlation Manager Overview..... | 177 |
| Define a Correlation Rule – Workflow..... | 179 |
| Correlation Manager User Interface..... | 185 |
| Chapter 6: CI Type Manager | 205 |
| CI Types Overview | 206 |
| CI Type Attributes | 207 |
| CI Type Relationships | 208 |
| System Type Manager..... | 208 |
| Create a CI Type | 209 |
| Create a Relationship Type | 210 |
| Create a Calculated Relationship Type | 212 |
| Create List and Enumeration Definitions..... | 213 |
| Enumeration Definition – Workflow | 214 |
| View Descriptions for CI Types and Relationships..... | 216 |
| CI Type Manager User Interface..... | 216 |
| Chapter 7: Topology Report Manager | 245 |
| Topology Report Manager Overview | 246 |
| Define a Report Rule – Scenario | 246 |
| Compare a CI Configuration to a Gold Master Template | 256 |
| Topology Report Manager User Interface | 256 |
| Troubleshooting and Limitations | 282 |

| | |
|--|------------|
| Chapter 8: Query Manager | 283 |
| Query Manager Overview..... | 283 |
| Create a TQL Query | 285 |
| Query Manager User Interface | 285 |
| Chapter 9: Enrichment Manager | 297 |
| Enrichment Manager Overview | 297 |
| Define an Enrichment Rule – Scenario | 300 |
| Enrichment Manager User Interface | 303 |
| Chapter 10: Topology Query Language | 323 |
| Topology Query Language (TQL) Overview..... | 324 |
| Topology Query Language | 324 |
| The Roles of TQL | 325 |
| Where TQL Queries Are Created | 325 |
| Viewing TQL Query Results..... | 326 |
| Compound Relationship | 326 |
| Join Relationship | 327 |
| Subgraph Definition | 328 |
| Define a TQL Query..... | 328 |
| Add Nodes and Relationships to a TQL Query | 330 |
| Add Enrichment Nodes and Relationships to an Enrichment TQL Query | 331 |
| Define a Compound Relationship — Scenario | 332 |
| Define a Join Relationship — Scenario | 335 |
| Create a Subgraph Definition — Scenario | 337 |
| Context Menu Options | 339 |
| Attribute Operator Definitions..... | 346 |
| TQL Logs..... | 348 |
| Topology Query Language User Interface..... | 352 |
| Troubleshooting and Limitations | 401 |
| Chapter 11: Using Calculated Relationships | 407 |
| Calculated Relationships Overview..... | 407 |
| Calculated Relationships | 408 |
| Calculated Relationship Types | 409 |
| Chapter 12: Create a URL for a Direct Link | 411 |
| Generate a Direct Link – Overview | 411 |
| Generate a Direct Link – Scenario | 413 |
| Generate Direct Link User Interface..... | 413 |

| | |
|--|------------|
| Chapter 13: Exporting the UCMDB Class Model to a UML Tool | 443 |
| Export to UML Tool – Overview | 444 |
| Export the Class Model | 444 |
| Convert XML of Selected Part of Class Model | 445 |
| Tool Plug-in Input | 447 |
| Exporting the Class Model to a UML Tool User Interface | 448 |

PART II: SETTINGS

| | |
|--|------------|
| Chapter 14: Infrastructure Settings Manager | 453 |
| Infrastructure Settings Manager – Overview | 453 |
| Infrastructure Settings Manager User Interface | 454 |
| Chapter 15: Package Manager..... | 457 |
| Package Administration Overview | 458 |
| Package Zip File Contents and Format..... | 459 |
| Packages for Federated CMDB Adapters..... | 460 |
| Create a Custom Package | 461 |
| Deploy a Package..... | 462 |
| Export a Package..... | 462 |
| Package Resources..... | 462 |
| Using the JMX Console to Perform Package Manager Tasks | 465 |
| Package Manager User Interface..... | 469 |
| Troubleshooting and Limitations | 483 |
| Chapter 16: Scheduler..... | 485 |
| Define Tasks that Are Activated on a Periodic Basis | 485 |
| Cron Expressions..... | 487 |
| Scheduler User Interface..... | 488 |
| Chapter 17: State Manager..... | 499 |
| State Manager Overview..... | 499 |
| Define an Attribute State..... | 500 |
| State Manager User Interface..... | 500 |
| Chapter 18: Report Schedule Manager | 503 |
| Report Schedule Manager — Overview..... | 503 |
| Report Schedule Manager User Interface | 504 |
| Chapter 19: Recipients Manager | 507 |
| Recipients Manager Overview..... | 507 |
| Define an Email Recipient..... | 507 |
| Recipients Manager User Interface..... | 508 |

| | |
|---|------------|
| Chapter 20: Federated CMDB | 511 |
|---|------------|

PART III: APPLICATION

| | |
|---|------------|
| Chapter 21: Topology View Application | 515 |
| Topology View Overview | 516 |
| Retrieve Correlation Results – Scenario..... | 516 |
| Take a Snapshot of a View..... | 525 |
| Print and Save a Topology Map to File | 526 |
| Topology View Application User Interface | 526 |
| Chapter 22: CI Lifecycle and the Aging Mechanism | 535 |
| The Aging Mechanism – Overview | 536 |
| CI Lifecycle – Overview..... | 537 |
| Enable and Run the Aging Mechanism..... | 538 |
| Generate CI Lifecycle Data and Filter the Results..... | 540 |
| CI Lifecycle User Interface..... | 541 |
| Aging Parameters | 550 |
| Chapter 23: Gold Master Report | 551 |
| Gold Master Report Overview | 551 |
| Gold Master Report User Interface | 551 |
| Chapter 24: Compare Snapshots | 557 |
| Compare Snapshots Overview | 557 |
| Snapshot Comparison | 557 |
| Compare Snapshots User Interface | 559 |
| Chapter 25: Compare CIs | 567 |
| CI Comparison Overview | 567 |
| CI Comparison | 568 |
| Compare CIs User Interface | 569 |
| Chapter 26: Asset Report | 577 |
| Asset Report Overview..... | 577 |
| Asset Report User Interface..... | 577 |
| Chapter 27: Host Dependency Report | 581 |
| Host Dependency Report Overview | 581 |
| Host Dependency Report User Interface | 582 |
| Chapter 28: Change Report | 585 |
| Change Report Overview | 585 |
| Change Report User Interface | 585 |

| | |
|--|------------|
| Chapter 29: Topology Report | 591 |
| Topology Report Overview..... | 591 |
| Generate and Send a Topology Report at Defined Intervals | 592 |
| Topology Report User Interface | 593 |
| Chapter 30: Report Manager | 597 |
| Report Manager Overview..... | 598 |
| Favorite Filters | 598 |
| Report Schedules | 599 |
| Work with the Report Manager — Workflow..... | 600 |
| Work with the Report Manager — Scenario | 601 |
| Create a Schedule | 604 |
| Report Manager User Interface..... | 605 |
| Chapter 31: Overview Reports | 617 |
| Overview Reports Overview | 617 |
| Overview Reports User Interface..... | 618 |

PART IV: USERS AND PERMISSIONS

| | |
|---|------------|
| Chapter 32: Users and Roles | 639 |
| Users and Roles Overview | 639 |
| Set Up Users..... | 640 |
| Users and Roles User Interface | 641 |
| Troubleshooting and Limitations | 648 |
| Chapter 33: User Profile | 649 |
| User Profile Overview | 649 |
| Define User Preferences..... | 650 |
| User Profile User Interface..... | 650 |
| Chapter 34: Security Manager | 653 |
| Security Manager Overview..... | 653 |
| Set Up Security | 654 |
| Assign Access Rights | 654 |
| Security Manager User Interface | 654 |
| Chapter 35: LDAP Manager | 661 |
| LDAP Manager Overview | 661 |
| Synchronize User Groups With LDAP | 662 |
| LDAP Manager User Interface | 664 |

PART V: VIEW EXPLORER

| | |
|---|------------|
| Chapter 36: Working with View Explorer | 669 |
| View Explorer Overview | 670 |
| Display a View in Browse Mode | 670 |
| Search for CIs in Search Mode | 671 |
| Modify View Explorer Display Options | 674 |
| View Explorer User Interface | 675 |
| Troubleshooting and Limitations | 685 |

PART VI: TOPOLOGY MAP

| | |
|--|------------|
| Chapter 37: Working with Topology Map | 689 |
| Topology Map Overview | 689 |
| Handling Large Views | 690 |
| Topology Map User Interface | 690 |
| Index | 725 |

Table of Contents

Welcome to This Guide

This guide explains how to configure and work with an IT model that enables you to build a topology of your system. You populate the model with configuration items and their relationships, and then use the model to measure and manage critical business processes.

This chapter includes:

- How This Guide Is Organized on page 13
- Who Should Read This Guide on page 14
- Getting More Information on page 15

How This Guide Is Organized

The guide contains the following chapters:

Part I Modeling

Describes how to model your business environment by defining views and by building TQL queries that retrieve the required information from the CMDB; describes how to create Topology reports based on a specific Report query and how to view and modify the definitions of configuration item types (CITs) defined in the UCMDB and the relationships that define the connections between them.

Part II Settings

Describes how to manage definitions, resources, and tools that enable you to discover IT infrastructure resources, how to define schedules for tasks that are activated on a periodic basis, how to configure settings to meet your organization's specifications, and how to enable specific recipients to automatically receive a specified report, via email, at regularly defined intervals.

Part III Application

Describes how to compare the hierarchies of two compound CIs or of two snapshots (taken at different times) of a view; describes the various reports listing CIs and relationships, their attribute values, changes, and other statistics.

Part IV Users and Permissions

Describes how to set up users and roles and grant permissions to roles to use components of the application; describes how to apply permissions to users and user groups to enable access to specific resources and resource instances in your business environment.

Part V View Explorer

Explains how View Explorer presents the elements of the IT universe model in HP Universal CMDB through the medium of views.

Part VI Topology Map

Explains Topology Map concepts and describes how to work with the Topology Map that shows the CIs and relationships defined in a view.

Who Should Read This Guide

This guide is intended for the following users of HP Universal CMDB:

- ▶ HP Universal CMDB administrators
- ▶ HP Universal CMDB platform administrators

- HP Universal CMDB application administrators
- HP Universal CMDB data collector administrators

Readers of this guide should be knowledgeable about enterprise system administration, have familiarity with ITIL concepts, and be knowledgeable about HP Universal CMDB.

Getting More Information

For a complete list of all online documentation included with HP Universal CMDB, additional online resources, information on acquiring documentation updates, and typographical conventions used in this guide, see the *HP Universal CMDB Deployment Guide* PDF.

Welcome to This Guide

Part I

Modeling

1

Configuration Management Database (CMDB)

This chapter provides information on CMDB.

This chapter includes:

Concepts

- CMDB Overview on page 19
- Configuration Items (CI) on page 21
- Nodes and Relationships on page 21

Reference

- CMDB Log Files on page 21
- Log Severity Levels on page 30

CMDB Overview

The CMDB is the central repository for the configuration information that is gathered from the Discovery and Dependency Mapping (DDM) process and the various third-party applications and tools.

The CMDB contains all the configuration items (CIs) and relationships created in HP Universal CMDB, whether created automatically from the DDM process or inserted manually. The CIs and relationships together represent a model of all the components of the IT Universe in which your business functions. The CMDB stores and handles the infrastructure data collected and updated by the DDM process. For more information about the DDM process, see *Discovery and Dependency Mapping Guide*.

The IT Universe model can be very large, containing millions of CIs. To facilitate their management, you work with the CIs in a view that provides a subset of the overall components in the IT Universe world.

You use factory views or views defined in View Manager or the Modeling Studio to display and manage the CIs and relationships in the CMDB. The views enable you to focus on specific IT areas and are available via View Explorer. An example of a view is shown in the following figure:

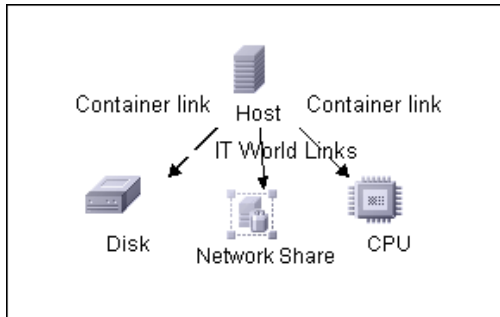

The CMDB also contains the TQL query definitions that are used to query and retrieve data from the CMDB, for presentation in the views; and the configuration item type (CIT) model, a repository for the CI types used to define the CIs and relationships. For information on TQL queries, see “Topology Query Language” on page 323.

Configuration Items (CI)

A configuration item (CI) is a component of the CMDB that represents a physical or logical entity in the system, for example, hardware, software, services, business processes, and customers. The CIs are part of the IT Universe model in the CMDB, where they are organized into a hierarchical format based on the interdependencies in your organization's IT environment. The interdependencies in HP Universal CMDB are called relationships.

Each CI belongs to a configuration item type (CIT). The CIT defines a category of CIs used in HP Universal CMDB. The CITs provide templates for creating the CIs and associated properties in each category. You view and manage the CIs in the CMDB using views. Each view shines a spotlight on part of the IT Universe model.

Nodes and Relationships

Nodes are the components from which TQL queries are built in Enrichment Manager, View Manager, Correlation Manager, Topology Report Manager, and Query Manager.

Relationships are connections defined between CIs. Relationships are defined one at a time for each pair of nodes in a TQL query.

CMDB Log Files

CMDB log files enable you to perform basic troubleshooting of CMDB runtime problems. Additionally, by tracking CMDB behavior in the log files, you can examine the effects of changes made in the system. CMDB is composed of subsystems and each subsystem records to several log files.

Log files are located in the **<HP Universal CMDB root directory>\UCMDBServer\j2f\log** folders.

This section includes the following topics:

- “CMDB Server Parameters” on page 22
- “CI Type Model Log” on page 24
- “CMDB Notification Log” on page 25
- “CMDB Model Audit Short Log” on page 26
- “History Database Log” on page 27
- “CMDB Enrichment Log” on page 27
- “CMDB Plug-in Log” on page 28
- “CMDB Dal Log” on page 28
- “CMDB Operation Statistics Log” on page 29

CMDB Server Parameters

This section contains definitions for CMDB server parameter log files. For details on changing log levels, see “Changing Log Levels” on page 30.

This section includes the following topics:

- “Lifecycle Log” on page 23
- “General CMDB Log” on page 23
- “Quota Log” on page 24

Lifecycle Log

The log name is **cmdb.info.log**.

| Log File | Description |
|-----------------------|--|
| Purpose | CMDB server lifecycle: <ul style="list-style-type: none"> ▶ all server tasks ▶ customer loading and unloading ▶ startup and shutdown of Task manager Contains information about any application that does not start up correctly. |
| Information Level | All lifecycle details. |
| Error Level | Startup errors of CMDB subsystems, primarily in the data access layer. |
| Debug Level | Not applicable |
| Basic Troubleshooting | <ul style="list-style-type: none"> ▶ If the CMDB client receives an exception that the customer does not exist, check that the customer is properly loaded. ▶ If the CMDB client receives an exception that it cannot find CMDB in a JNDI lookup, check that the CMDB server is bound in the JNDI tree. ▶ If the HA Controller does not load the CMDB customers, check that the CMDB server is registered in the HA controller. |

General CMDB Log

The log name is **cmdb.log**.

| Log File | Description |
|-------------------|--|
| Purpose | Errors of all CMDB subsystems and CMDB CITs that do not have their own log file. |
| Information Level | Information from the CMDB server not directed to any specific log. |
| Error Level | All errors in the CMDB server. |

| Log File | Description |
|-----------------------|--|
| Debug Level | Debug information in the CMDB server that is not directed to a specific log. |
| Basic Troubleshooting | CMDB server errors during CMDB deployment. |

Quota Log

The log name is **cmdb.quota.log**.

| Log File | Description |
|-----------------------|---|
| Purpose | Quota names, quota values, and current quota levels. |
| Information Level | Quota names and values set in the server and customer levels during a customer load. |
| Error Level | CMDB operations that fail because they exceed quota limits. |
| Debug Level | A count collector runs every n minutes and gathers current counts for all quotas. Collected counts are logged. |
| Basic Troubleshooting | If operations fail because of quota limits, check the count growth and quota values. |

CI Type Model Log

The log name is **cmdb.classmodel.log**.

| Log File | Description |
|-------------------|--|
| Purpose | CI Type Model errors and debug messages. |
| Information Level | When a CI Type Model is loaded, incorrect definitions are logged as informational messages. An example of an incorrect definition is duplicate attributes . |
| Error Level | Not available. |

| Log File | Description |
|-----------------------|---|
| Debug Level | <p>Every CI Type update includes the following:</p> <ul style="list-style-type: none"> ▶ original CIT in XML format ▶ new CIT in XML format ▶ differences between the CITs <p>If the CI Type Model update is rejected, the reason is logged.</p> |
| Basic Troubleshooting | <p>Compares the differences that the server finds between the original CIT and the new CIT. This is useful to understand the following scenarios:</p> <ul style="list-style-type: none"> ▶ a CIT in a package failed ▶ an action in the CIT browser applet failed ▶ an action in the CIT browser applet succeeded when it should have failed |

CMDB Notification Log

The log name is `cmdb.notification.log`.

| Log File | Description |
|-------------------|--|
| Purpose | <p>Notification messages from the time of the component's creation in CMDB until the client's listener receives a message. Most components receive configuration changes from CMDB in push mode, by the notification mechanism, rather than in pull mode.</p> |
| Information Level | <ul style="list-style-type: none"> ▶ startup and shutdown of publishers ▶ register and unregister remote and internal listeners |
| Error Level | <ul style="list-style-type: none"> ▶ errors when messages are published ▶ errors when messages are received |
| Debug Level | <ul style="list-style-type: none"> ▶ unique message ID ▶ number of changes that a message includes as well as more details according to the type of the message (for example, the TQL result version) ▶ JMS header properties |

| Log File | Description |
|-----------------------|--|
| Basic Troubleshooting | <p>If an application does not receive a notification, check the following:</p> <ul style="list-style-type: none"> ▶ a listener is registered with the appropriate notification filter ▶ a message is published with data that matches this filter ▶ a message is received by the listener (use the unique message ID to verify) |

CMDB Model Audit Short Log

The log name is `cmdb.model.audit.short.log`.

| Log File | Description |
|-----------------------|--|
| Purpose | <p>Information about a CI Type operation: type of operation, data received as input, and what happened to the data in each CIT.</p> <p>Also contains information about the caller application, execution times, and persistency time.</p> |
| Information Level | Operation details |
| Error Level | Not available. |
| Debug Level | Not available. |
| Basic Troubleshooting | <p>If there are no changes when there should be, check the following:</p> <ul style="list-style-type: none"> ▶ the operation exists ▶ the input is correct ▶ what happened to the data. There may have been a false update. <p>This is especially useful when running DDM to trace the input.</p> |

History Database Log

The log name is `cmdb.history.log`.

| Log File | Description |
|-------------------|---|
| Purpose | <ul style="list-style-type: none"> ➤ Records which CITs are found by the History database when the database is initialized from an existing topology. ➤ Records what is to be saved in the History database. ➤ Tracks events saved in the History database. ➤ Records when the History database was purged. |
| Information Level | <ul style="list-style-type: none"> ➤ When the last purge was carried out. ➤ Information about initialization of the History database. |
| Error Level | Lists errors that occur when event information is inserted in the History database. |
| Debug Level | <ul style="list-style-type: none"> ➤ Details about CITs inserted during initialization of the History database. ➤ Details about changes in the TQL results saved in the History database. |

CMDB Enrichment Log

The log name is `cmdb.enrichment.log`.

| Log File | Description |
|-------------------|---|
| Purpose | <p>Enrichment definitions: adding, updating, removing, and calculating.</p> <p>Calculation results such as how many CIs were added, how many relationships were removed, and so forth.</p> <p>Supplies the reason for a calculation failure. Failure in a model update, however, is not included since it is an asynchronous execution.</p> |
| Information Level | <ul style="list-style-type: none"> ➤ Add, update, and remove enrichment definitions. ➤ Add, update, and remove CIs or relationships to or from a model. |
| Error Level | Calculation failure. |

| Log File | Description |
|-----------------------|--|
| Debug Level | Traces the enrichment calculation process. |
| Basic Troubleshooting | <ul style="list-style-type: none"> ▶ If no calculation was carried out, check the definition of add enrichment. ▶ If there are no results, check the finish calculate entry. |

CMDB Plug-in Log

The log name is `cmdb.plugins.log`.

| Log File | Description |
|-----------------------|---|
| Purpose | Plug-in input and output notification. |
| Information Level | Lifecycle of publisher. |
| Error Level | <ul style="list-style-type: none"> ▶ no customer name exists in the customer ID ▶ publisher failure |
| Debug Level | Receive or send a change. |
| Basic Troubleshooting | If notification did not reach the destination, check that the plug-in received the input. |

CMDB Dal Log

The log name is `cmdb.dal.log`.

| Log File | Description |
|-------------------|---|
| Purpose | Information about activity that occurred in the data access layer, the layer that works with CMDB. |
| Information Level | Not available. |
| Error Level | <ul style="list-style-type: none"> ▶ connection pool errors ▶ database errors ▶ command execution errors |

| Log File | Description |
|-----------------------|--|
| Debug Level | <ul style="list-style-type: none"> ▶ all DAL commands executed ▶ all SQL commands executed |
| Basic Troubleshooting | <p>If you suspect that CMDB actions are taking too long, check the time spent on queries and updates in the DAL logs and operation logs.</p> <p>Exception details and ID are entered into the log. The exception ID appears in the exception itself.</p> |

CMDB Operation Statistics Log

The log name is `cmdb.operation.statistics.log`.

| Log File | Description |
|-----------------------|--|
| Purpose | Statistics for all operations performed in the past 15 minutes including worst operation instances. |
| Information Level | <p>Statistics per operation including operation class name, caller application, and customer ID.</p> <p>Default of 10 worst operation instances.</p> |
| Error Level | Disables the statistics feature. |
| Debug Level | Not available. |
| Basic Troubleshooting | Check when there is a performance slow down. |

Log Severity Levels

Each log is set so that the information it records corresponds to a certain severity threshold. Because the various logs are used to keep track of different information, each is pre-set to an appropriate default level. For details on changing the log level, see “Changing Log Levels” below.

Typical log levels are listed below from narrowest to widest scope:

- ▶ **Error.** The log records only events that adversely affect the immediate functioning of HP Universal CMDB. When a malfunction occurs, you can check if Error messages were logged and inspect their content to trace the source of the failure.
- ▶ **Warning.** The log’s scope includes, in addition to Error-level events, problems for which HP Universal CMDB is currently able to compensate and incidents that should be noted to prevent possible future malfunctions.
- ▶ **Info.** The log records all activity. Most of the information is normally routine and of little use and the log file quickly fills up.
- ▶ **Debug.** This level is used by HP Software Support when troubleshooting problems.

Note: The names of the different log levels may vary slightly on different servers and for different procedures. For example, **Info** may be referred to as **Always logged** or **Flow**.

Changing Log Levels

If requested by HP Software Support, you may have to change the severity threshold level in a log, for example, to a debug level.

To change the severity threshold level:

- 1 Open the log properties file in a text editor. Log file properties are defined in files in the following directory: **<HP Universal CMDB root directory>\UCMDBServer\j2f\conf\core\Tools\log4j.**

2 Locate the **loglevel** parameter. For example,

```
loglevel=ERROR
```

3 Change the level to the required level. For example,

```
loglevel=DEBUG
```

4 Save the file.

2

IT Universe Manager

This chapter provides information on IT Universe Manager.

This chapter includes:

Concepts

- ▶ IT Universe Manager Overview on page 34
- ▶ Working with Views in IT Universe Manager on page 35
- ▶ View Tree Structure on page 36
- ▶ Working with CIs on page 37
- ▶ Working with Relationships on page 41

Tasks

- ▶ Create CIs and Relationships in the CMDB on page 45
- ▶ Check Status of Application Discovery (Rediscover a View) on page 46

Reference

- ▶ IT Universe Manager User Interface on page 49

IT Universe Manager Overview

IT Universe Manager enables you to manage the content of your IT Universe model. The following tasks represent the basic functionality of the application:

- ▶ **Creating CIs without creating relationships.** You can define new CIs that are added to the CMDB individually, so that no new relationships are created. For details, see “Creating a Non-Related CI” on page 38.
- ▶ **Creating CIs with relationships for them.** You can define new CIs and attach them to existing CIs, so defining a new CI and a new relationship in the CMDB. For details, see “Creating a Related CI” on page 38.
- ▶ **Adding existing CIs and creating relationships for them.** You can attach CIs to an existing CI, so creating new relationships for existing CIs. For details, see “Attaching Existing CIs” on page 43.
- ▶ **Deleting CIs.** You can delete CIs from the CMDB. For details, see “Deleting CIs” on page 39.

Populating the IT Universe Model

The IT Universe model in the CMDB contains the CIs and relationships produced by the CI-generating tools that operate within HP Universal CMDB. Most CIs and relationships originate from one of the following sources:

- ▶ **Discovery and Dependency Mapping (DDM).** Automatically creates CIs and relationships based on the discovered IT resources and topology in your company’s infrastructure. For details, see “Discovery and Dependency Mapping – Overview” in *Discovery and Dependency Mapping Guide*.
- ▶ **IT Universe Manager.** Enables you to manually create CIs and relationships that represent logical and physical elements of the business. For details, see “Working with CIs” on page 37.
- ▶ **Enrichment Manager.** Enables you to add CIs and relationships to the CMDB by receiving data from the attributes of Enrichment nodes as defined in the Enrichment TQL query. For details, see “Enrichment Manager” on page 297.

Working with Views in IT Universe Manager

In IT Universe Manager, you analyze data at the view level. Views are subsets of the IT Universe, containing only those CIs relating to a specific area of interest. All views are based on a pattern which determines the content of the view.

- ▶ Pattern views and template based views are built from a TQL (Topology Query Language) query that defines the structure of the view. The view displays only those CIs and relationships that satisfy the query definition. You build pattern views and template based views in View Manager, while TQL queries are defined in Query Manager.
- ▶ Perspective based views are built manually, by selecting a group of CIs and applying a perspective to them. The perspective is a pattern used to define which related CIs are included in the view. You build perspective based views in the Modeling Studio.

For information on the different view types and how they function, see “View Formats” on page 130.

Note: You must have **Change** permissions for a view to edit a view. If you do not have the necessary permissions, contact your HP Universal CMDB Administrator.

CIs created by DDM are automatically added to each view where the CIs (and their relationships) fit the TQL definition for the view. When you open a view in View Explorer, the TQL query for the view queries the CMDB for CIs that match the defined pattern. If there are no matches (for example, in the case of a view for a DDM process where the process has not yet run) then the view remains empty.

When you define a new CI while working in any view in IT Universe Manager, the CI (and any associated relationship) is created in the CMDB. The CI is added to your current view only if it meets the view’s TQL specifications.

If the created CI and relationship do not meet the TQL requirements, then the CI and relationship are created in the CMDB but are not visible in the view. Similarly, if you attach an existing CI to a CI in the view, and the new pattern does not meet the TQL requirements, then the attached CIs do not appear in the view, but the relationship is still created.

View Lifecycle

If you do not access a view from View Explorer for a specified period of time, the view is cleared out, to save memory in the system. It is not deleted from the CMDB; the view can be retrieved by clicking on it. The default time period for clearing out unused views is one hour.

Note: Views defined as persistent are not cleared out and always remain in the memory.

View Tree Structure

Views are organized in a hierarchical tree format in the left pane of IT Universe Manager, which is known as View Explorer (it is also called CI Selector). The view name appears in the View box above the tree and acts as the containing folder for the CIs in the view.

The first level of the View Explorer tree consists of the nodes for the root CIs. A root CI is the starting point for a view subtree. A view may contain any number of subtrees. Under the root CIs come the branch CIs, expanding down to the leaf CIs as the last nodes at the ends of each branch.

The CIs at each level in a subtree are considered to be attached to the CI on the branch directly above. This attachment generally depicts a dependent relationship, so that the higher branch (closer to the root CI) represents a component of your business that depends on the CIs on the next branch down (closer to the leaf CIs) in the business process. For example, an application depends on the servers running the application.

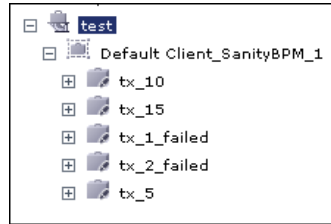

The attachment between a higher node and lower node is referred to as a parent-child relationship. The parent CI may have many attached child CIs, and the child CIs pass operational status to the parent.

The tree topology is determined by the folding rules defined for the view. In a pattern view, these are defined for the specific view. In a template based or a perspective based view, the folding rules are defined as part of the template or perspective. For details on defining folding rules, see **Add Rule** in “Context Menu Options” on page 339.

Working with CIs

In IT Universe Manager, you can create related and non-related CIs, delete CIs, edit the CI properties, and remove out-of-date CIs using the Aging Mechanism.

This section includes the following topics:

- “Creating a Non-Related CI” on page 38
- “Creating a Related CI” on page 38
- “Deleting CIs” on page 39

- “CI Properties” on page 39
- “Removing Out of Date CIs Using the Aging Mechanism” on page 40

Creating a Non-Related CI



You can define a new CI in IT Universe Manager by clicking the **New CI** button in the toolbar. The New CI dialog box opens, which enables you to define the properties for the new CI. The CI is created in the CMDB. For details, see “New CI Dialog Box” on page 74.

Note: The CI is added to the view only if it meets the specifications of the pattern, template, or perspective of the view.

A CI created in this way is added as an independent entity without any relationship to any other existing CI in the CMDB.

Creating a Related CI

You can define a new CI to be added as a parent, child, or sibling of an existing CI.

To define a new related CI:

- 1 Select the CI in your view to which you want to attach the new CI.
- 2 Click the **New Related CI** button in the toolbar.
- 3 In the New CI dialog box, define the properties and relationship for the CI. For details, see “New CI Dialog Box” on page 74.



The CI and relationship are created in the CMDB.

Note: The CI and relationship are added to the view only if they meet the specifications of the pattern, template, or perspective of the view.

Deleting CIs

You can delete a CI by selecting **Delete from CMDB** from the context menu in IT Universe Manager. The CI is deleted from the CMDB and from all views. If the CI has children, they are not automatically deleted when you delete the parent CI. If you delete a CI without first deleting the relationship between the CI and any child CIs that appear with the parent CI in a view, the child CIs are removed from the view.

If the child CIs do not appear in any other view, they remain in the CMDB without appearing in a view. The child CIs might appear in the future in views where they meet the pattern requirements.

One exception to this rule is when the relationship between a child and parent CI is a **Container link**; in that case, when the parent CI is deleted, the contained CI is also removed from the CMDB. For example, if a host CI is the container for a child CPU CI, then when the host CI is deleted, the CPU is also removed from the CMDB.

When you delete a CI that was created by the DDM process, the CI is restored the next time that DDM runs (if the CI is still valid), and it reappears in all relevant views.

CI Properties

In IT Universe Manager, you can edit the properties of a CI. The CI properties are divided into several categories which appear in the New CI dialog box:

- ▶ The general properties of a CI are common to all CIs. Some general properties are defined automatically during CI creation; others can only be defined manually in the New CI dialog box.
- ▶ CIT-specific properties are created as part of the CIT definition in the CI Type Manager. The values for the CIT-specific properties are taken from the CIs discovered during DDM. The values can also be entered manually, when you manually create CIs to represent entities in your infrastructure. For details, see “CI Type Manager” on page 205.
- ▶ Key properties can be general or CIT-specific properties, which must be assigned a value to create an instance of the CI type.

You can access the Configuration Item Properties dialog box to view the CI properties from IT Universe Manager by right-clicking the CI and selecting **Properties** from the context menu or by clicking the Properties tab in the Advanced pane. You can edit the CI properties as well if you have the necessary permissions for editing CIs. For details on CI properties, see “Configuration Item Properties Dialog Box” on page 53.

The CIT-specific properties are displayed in the **Specific Properties** section of the Configuration Item Properties dialog box when you sort the properties using the **Categorized** button. Some properties for the automatically created CIs can be edited; however, if the CI is configured to **Allow CI Update** (in the General Properties), then DDM may override your changes when it updates the CI. A description of the selected property can be found in the Description area at the bottom of the Configuration Item Properties dialog box.

Some of the CIT-specific properties for DDM CIs are set by default to be monitored for changes. When one of these properties has been modified, information on the change can be viewed in a change report. For more information, see “Change Report” on page 585.

Removing Out of Date CIs Using the Aging Mechanism

If a CI or relationship is not updated or refreshed over a period of time (for example, a CI is not rediscovered by DDM and no manual update occurs), an aging mechanism deletes the CI from the CMDB. For details, see “The Aging Mechanism – Overview” on page 536.

Working with Relationships

Many of the relationships between CIs in the CMDB are created automatically, for example, by DDM. In addition, you can create relationships manually in IT Universe Manager, Enrichment Manager, Correlation Manager, Query Manager, Topology Report Manager, or View Manager.

This section includes the following topics:

- “Creating Relationships” on page 41
- “Creating Hierarchical Relationships” on page 42
- “Attaching Existing CIs” on page 43
- “Adding Folding Rules to Relationships” on page 44
- “Deleting Relationships” on page 44

Creating Relationships

You can create relationships by right-clicking a CI or multiple CIs in the View Explorer pane or the Topology Map and selecting **Relate to CI** from the context menu. In the Topology Map, you can define a relationship between two CIs in the view by drawing a line between the two, using the **Create Relationship** button from the toolbar. Either of these actions opens the Insert Relationship dialog box. For details, see “Insert Relationship Dialog Box” on page 61.



You can create as many relationships as necessary between a CI in the CMDB and other CIs. Each new relationship exists as its own entity in the CMDB, and has its own properties that can be edited in IT Universe Manager (as described in “Configuration Item Properties Dialog Box” on page 53). You can also create more than one relationship between the same two CIs, when each relationship is based on a different relationship type. In the following example, **host7** has both a **Backbone** and a **Talk** relationship with **host8**.

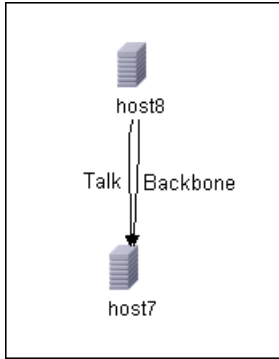

Creating Hierarchical Relationships

By attaching one CI to another in IT Universe Manager you create a hierarchical relationship (parent-child) between them, so that one CI is influenced by the other.

Certain relationships defined in this way are restricted to the relationship type **Depends On** (if the relationship is between two non-monitoring CIs), or the relationship type **Monitored By** (if the child CI in the relationship is a monitor type CI); however, other relationship types are used between specific types of CIs. For example, if a relationship is defined between two Host CIs, there are several possible relationship types.

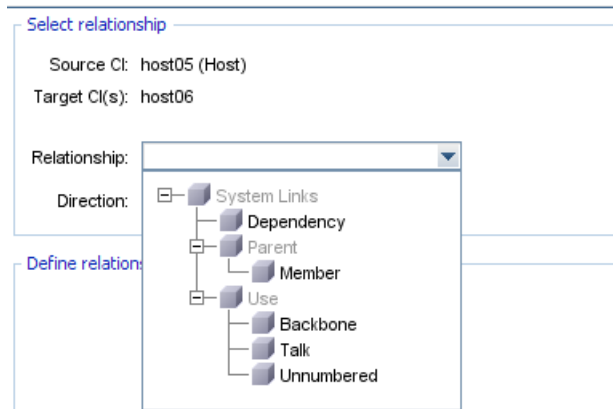

Note: When you attach a child CI to a parent CI, you are creating that relationship in the CMDB. The child therefore impacts on the parent CI in every view where the relationship exists, and is displayed in every view where the child and relationship match the TQL.

Attaching Existing CIs

You can attach existing CIs using the Insert Relationship dialog box. The dialog box has two modes:

- Selecting the CIs that you want to attach.
- Defining the relationship between the original CI and the CIs to attach. For information on relationships, see “Working with Relationships” on page 41.

When selecting the CIs to attach, you can select multiple CIs from a view to attach to the original CI. However, all CIs that you want to attach in one operation must have the same relationship type. For example, you cannot attach a CI that uses the relationship **Depends On** in the same operation as a CI that uses the relationship **Monitored By**.

You cannot create an identical relationship between the same CIs twice within a view. For example, if parent CI Italy depends on child CI Rome, Rome appears under the CI Italy in the view. If you then again attach Rome to Italy with a **Depends On** relationship, Rome still appears once only under that parent CI.

Adding Folding Rules to Relationships

After setting the node and relationship definitions of a view, you can add folding rules to selected relationships in View Manager. This enables you to define the organizational structure of CIs in the Topology Map by displaying selected CIs at different levels. When no folding rules are defined, the Topology Map displays all CIs included in the query results on one level by default. For example, if the query results include hosts and networks, both CI types are displayed on the same level in the Topology Map.

Note: The maximum number of CIs that can be displayed in a single layer is 900. If a view contains a layer with more than 900 CIs, the view is not displayed in the Topology Map until the folding rules are changed.

For details on adding folding rules, see **Add Rule** in “Context Menu Options” on page 339.

Deleting Relationships

The Topology Map shows only the relationships for the CIs that are part of the current view; however, the same relationships may also be part of other views. When you delete a relationship in IT Universe Manager, it is deleted from the CMDB and from all views.

When a relationship is deleted, the CI on the other end of the relationship may remain in the view, if it still matches the pattern of the view. In a perspective based view, you can remove the CI completely from the view (without deleting it from the CMDB), by deleting it from the view in the View Editor in the Modeling Studio.

When you delete a relationship that was created by the DDM process, the relationship is restored the next time that DDM runs (if the relationship is still valid), and it reappears in all relevant pattern views.

It can take a few minutes to delete subtrees, or multiple CIs and relationships, from a view.

Create CIs and Relationships in the CMDB

This task describes how to create related and non-related CIs, as well as relationships between CIs, in the CMDB.

This task includes the following steps:

- ▶ “Define a New Non-related CI” on page 45
- ▶ “Define a New Related CI” on page 45
- ▶ “Attach Existing CIs” on page 46

1 Define a New Non-related CI



Click the **New** CI button in the toolbar. In the New CI dialog box, select a CI type from the tree and define the properties for the new CI. For details, see “New CI Dialog Box” on page 74.

2 Define a New Related CI



Click the **New** Related CI button in the toolbar. In the New CI dialog box, select a CI type from the tree and define the properties for the new CI. On the Relationship page of the dialog box, select the type of relationship and define its properties. For details, see “New CI Dialog Box” on page 74.

3 Attach Existing CIs

Select a CI in a view. Right-click the CI and select **Relate to CI**. In the Insert Relationship dialog box, select a target CI. On the Relationship page of the dialog box, select the type of relationship and define its properties. For details, see “Insert Relationship Dialog Box” on page 61.

Check Status of Application Discovery (Rediscover a View)

You, the application owner or administrator, need to be kept informed of any problems to your application. So, for example, you need to know that discovery is working correctly and that its current configuration can connect to the application database. This section explains how to run the rediscovery procedure that enables you to check the current status of the discovery of an application.

Note:

- ▶ Set up and configuration is performed by the UCMDB administrator. For details, see “Prerequisites” on page 47.
 - ▶ Rediscovery is performed by the application owner/administrator. For details, see “Access the View” on page 48.
 - ▶ You do not need any knowledge of Discovery and Dependency Mapping (DDM) to run this procedure.
 - ▶ By default, you can run the rediscovery procedure on views that include less than 10,000 CIs. For details on changing this number, see “Important Information” on page 59.
-

This task includes the following steps:

- “Prerequisites” on page 47
- “Access the View” on page 48
- “View Results in the View” on page 48
- “Schedule the Rediscovery” on page 48

1 Prerequisites

Note: This step is performed by the UCMDB administrator.

- a** In DDM, create a module that contains the jobs that must discover the application. For details, see “Run Discovery – Advanced Mode Workflow” in *Discovery and Dependency Mapping Guide*.
- b** Activate the module and all the jobs. The jobs must remain activated.
- c** Verify that the module has run without errors. For details, see “Manage Errors” and “Discovery Status Pane” in *Discovery and Dependency Mapping Guide*.
- d** Correct any errors in the application and confirm that DDM finds no errors during the next run.
Important: The application owner cannot rediscover a view if DDM is reporting errors. You must set an error-free baseline.
- e** In View Manager, define a view that includes the application CI or CIs to be rediscovered. These are the CIs that are created when you activate the jobs that discover the application. For details, see “View Manager Overview” on page 130.
- f** Notify the application owner of the name of the view.

2 Access the View

Note: This step is performed by the application owner/administrator.

In IT Universe Manager, access the view that includes the application CIs to be rediscovered. For details, see “Search for CIs in Search Mode” on page 671.

3 View Results in the View



a You need to check the complete application. You click the **Show Discovery and Changes Summary** button in the CI Selector toolbar. The **Show Discovery Status and Changes of View** dialog box is displayed. The dialog box displays information about which jobs and trigger CIs discovered the CIs in the view, on the last occasion that DDM ran the discovery for the jobs. For details, see “Discovery and Changes Summary Dialog Box” on page 59.

To run the discovery, click the **Rerun Discovery** button. To view information about the jobs and trigger CIs, use the links to drill down. For details, see “Managing Problems With Error Reporting” in *Discovery and Dependency Mapping Guide*.

b You need to check specific components of your application. You select the component’s CI in the Topology Map pane and display the Discovery tab in the Advanced pane. For details, see “Discovery and Changes Summary Dialog Box” on page 59.

To rediscover several CIs, press CTRL, select the CIs and display the Discovery tab.

To run the discovery, click the **Rerun Discovery** button.

4 Schedule the Rediscovery

You can schedule how often the rediscovery procedure should run. In the Job Definition window, choose the **Rerun Discovery on View** action. For details, see “Job Scheduler Window” on page 495.

IT Universe Manager User Interface

This section describes:

- Add Background Image Dialog Box on page 50
- CI/Relationship History Dialog Box on page 51
- Configuration Item Properties Dialog Box on page 53
- Discovery and Changes Summary Dialog Box on page 59
- Get Related CIs Report on page 60
- Insert Relationship Dialog Box on page 61
- IT Universe Manager Window on page 66
- New CI Dialog Box on page 74
- Related CIs in View/Database Map on page 80

Add Background Image Dialog Box

| | |
|------------------------------|---|
| Description | <p>Enables you to add an image as a background to a view as a navigational aid.</p> <p>To access: In IT Universe Manager, select Layout > Add Background Image from the toolbar.</p> |
| Important Information | <p>You can add an image file (of .gif type) as the background image of a view. This can be used as a navigational aid, for example, for global networks containing different networks in different countries.</p> <p>You can add additional background images to the existing list by inserting image files (of .gif type) to the following location:</p> <p><HP Universal CMDB root directory>\UCMDBServer\j2f\AppServer\webapps\site.war\images\gui\mam_images\gui\images\backgrounds.</p> <p>Tip: Before copying this URL to a browser, copy to a text editor and remove the break markups ().</p> <p>Note: This option is only active when Manual Layout is selected as the layout for the view.</p> |



The following elements are included (unlabeled GUI elements are shown in angle brackets>):

| GUI Element (A–Z) | Description |
|-------------------------|--|
| Background Image | Displays the selected image. |
| File Name | <p>Contains a list of the available image files. Select the file name of the image you want to appear in the view and click OK. To remove an image from a view, select None in the File Name list and click OK. Select Layout > Save Layout to save your changes.</p> |

CI/Relationship History Dialog Box

| | |
|--------------------|---|
| Description | <p>Displays a list of attributes in which changes have occurred as well as the differences between two configuration files.</p> <p>To access:</p> <ul style="list-style-type: none"> ▶ In IT Universe Manager, right-click the selected CI or relationship in View Explorer or the Topology Map and select CI History from the context menu. ▶ In Discovery and Dependency Mapping, in the Discovered by [Module or Job Name] CIs dialog box, right-click a CI and choose CI History. |
|--------------------|---|

The following elements are included (unlabeled GUI elements are shown in angle brackets>):

| GUI Element (A–Z) | Description |
|---|---|
|  | Click Refresh to refresh the data in the table. |
|  | View the difference between two configuration files. Select two CIs of type configfile and click the Show difference button to open the Visualdiff report, which displays a comparison of the two files. Text added to the second file appears highlighted in yellow. Text removed from the first file appears highlighted in red. Differences between the files appear highlighted in green. |





| GUI Element (A–Z) | Description |
|---|--|
|  | <p>Choose the export format for the table data. The available options are:</p> <ul style="list-style-type: none"> ➤ Excel. The table data is formatted as an .xls (Excel) file that can be displayed in a spreadsheet. ➤ PDF. The table data is exported in PDF format. ➤ RTF. The table data is exported in Rich Text Format. ➤ CSV. The table data is formatted as a comma-separated values (CSV) text file that can be displayed in a spreadsheet. <p>Note: For the CSV formatted table data to display correctly, the comma (,) must be defined as the list separator. In Windows, to verify or modify the list separator value, open Regional Options from the Control Panel, and on the Numbers tab ensure that the comma is defined as the List Separator value. In Solaris, you can specify the list separator in the application that opens the CSV file.</p> <ul style="list-style-type: none"> ➤ XML. The table data is formatted as an XML file that can be opened in a text or XML editor. <p>Tip: To extract HTML code from the report:</p> <ul style="list-style-type: none"> ➤ Save the file as HTML ➤ Open the file in an HTML editor ➤ Copy the relevant table into the target file |
| Attribute | The name of the attribute. |
| Change Date | The date when the last change occurred. |
| Filter by | <p>Filter the data in the table by one or more of the following filters:</p> <ul style="list-style-type: none"> ➤ Time Range. Select the time period for which the CI history is displayed. ➤ Change Type. Select the type of changes displayed in the table. ➤ Attribute. Select the attribute types displayed in the table. |

| GUI Element (A–Z) | Description |
|--------------------|--|
| Modified By | Indicates the cause of the change. For example, the field can contain the name of a user or a DDM job. |
| New Value | The new value of the attribute. |
| Old Value | The previous value of the attribute. |

Configuration Item Properties Dialog Box

| | |
|------------------------------|---|
| Description | <p>Enables you to view and edit basic information for an existing CI or relationship.</p> <p>To access: Select Admin > Modeling > IT Universe Manager and use one of the following:</p> <ul style="list-style-type: none"> ▶ Select a CI in the topology map or View Explorer. In the Advanced Pane, select the Properties tab and click Edit. ▶ Right-click a CI in View Explorer or the Topology map and select Properties. |
| Important Information | <p>The Configuration Item Properties dialog box contains two types of properties:</p> <ul style="list-style-type: none"> ▶ General properties, which include general information about the CI or relationship. These properties are common to all CITs and are documented below. ▶ CIT-specific properties, which include properties specific to that CI. These properties vary according to the type of CI or relationship and are not documented. <p>When you sort the properties by category, the CIT-specific properties appear at the top of the list and the general properties appear at the bottom.</p> <p>You can view a description of the selected property in the Description Area at the bottom of the dialog box. Click the Show/Hide Description Area button to display the Description Area.</p> <p>Mandatory fields are denoted by an asterisk.</p> |
| Useful Links | “The Aging Mechanism – Overview” on page 536 |

The following elements are included (unlabeled GUI elements are shown in angle brackets>):

| GUI Element (A-Z) | Description |
|---|--|
|  | Click to display the properties by category. |
|  | Click to display the properties alphabetically. |
|  | Toggles between showing and hiding the description area at the bottom of the Properties window. |
|  | Click Expand to expand the properties tree when the properties are displayed by category. |
|  | Click Collapse to collapse the properties tree when the properties are displayed by category. |

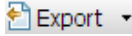
| GUI Element (A–Z) | Description |
|---|--|
|  | <p>Choose the export format for the table data. The available options are:</p> <ul style="list-style-type: none"> ▶ Excel. The table data is formatted as an .xls (Excel) file that can be displayed in a spreadsheet. ▶ PDF. The table data is exported in PDF format. ▶ RTF. The table data is exported in Rich Text Format. ▶ CSV. The table data is formatted as a comma-separated values (CSV) text file that can be displayed in a spreadsheet. <p>Note: For the CSV formatted table data to display correctly, the comma (,) must be defined as the list separator. In Windows, to verify or modify the list separator value, open Regional Options from the Control Panel, and on the Numbers tab ensure that the comma is defined as the List Separator value. In Solaris, you can specify the list separator in the application that opens the CSV file.</p> <ul style="list-style-type: none"> ▶ XML. The table data is formatted as an XML file that can be opened in a text or XML editor. <p>Tip: To extract HTML code from the report:</p> <ul style="list-style-type: none"> ▶ Save the file as HTML ▶ Open the file in an HTML editor ▶ Copy the relevant table into the target file |
| Actual Deletion Period | The number of days after which the CI or relationship is deleted. |
| Allow CI Update | <p>When selected, this option allows the DDM process to automatically update the CI or relationship properties with information that it discovers. If you change the value of a property supplied by the DDM process, the value is overridden by the discovered value.</p> <p>When this option is cleared, the CI or relationship properties are not overridden by the DDM process.</p> |
| Apply | Click Apply to save the changes made to the CI or relationship properties. |

| GUI Element (A–Z) | Description |
|----------------------------------|---|
| City | <p>The name of the city. The list is automatically updated when you select a country (or state, when applicable). Select an option from the list.</p> <p>Note: This field does not appear for relationships.</p> |
| CI Type | <p>The type of the CI or relationship (read-only value). For information about CITs in HP Universal CMDB, see “CI Type Manager” on page 205.</p> |
| Country | <p>The country in which the CI is located. Select an option from the list.</p> <p>Note: This field does not appear for relationships.</p> |
| Created By | <p>The user name of the administrator who manually created the CI or relationship, where applicable (read-only value).</p> |
| Create Time | <p>The date and time when the CI or relationship was created.</p> |
| Deletion Candidate Period | <p>The number of days after which the CI or relationship becomes a candidate for deletion.</p> |
| Description | <p>A brief description of the CI or relationship.</p> |
| Display Label | <p>The name of the CI or relationship as it appears in View Explorer.</p> |
| Edit | <p>In the Properties tab of the Advanced pane, you can view a CI's properties but you cannot edit them. Click Edit to open the Configuration Item Properties dialog box where you can edit the properties.</p> |

| GUI Element (A–Z) | Description |
|-------------------------|--|
| Enable Aging | <p>If a CI or relationship is not updated or refreshed over a period of time (for example, a CI is not rediscovered by DDM and no manual update occurs), an aging mechanism deletes the CI from the CMDB. For details, see “The Aging Mechanism – Overview” on page 536.</p> <p>True: the aging mechanism is enabled for this CI or relationship.</p> <p>Default value: false. The default value for DDM CIs is true.</p> <p>Note:</p> <ul style="list-style-type: none"> ▶ If the aging mechanism is disabled, this field is ignored. ▶ This field is displayed for certain CIs only. |
| ID | The internal ID of the CI or relationship in the CMDB (read-only value). |
| Last Access Time | <p>The time that the CI was last accessed, whether when being updated or being discovered by DDM. This field is only displayed for certain CIs.</p> <p>This parameter is used by the aging mechanism. For details, see “The Aging Mechanism – Overview” on page 536.</p> |
| Name | The name of the CI or relationship. |
| Note | Enables you to enter other information about the CI or relationship. |
| Origin | An ID for the source that automatically created the CI or relationship, or the application where the CI or relationship was created (read-only value). |
| Reset | Click the Reset button to restore the original property settings of the CI or relationship. |
| State | <p>The name of the state – when applicable for the selected country. The list is automatically updated when you select a country. Select an option from the list.</p> <p>Note: This field does not appear for relationships.</p> |
| Updated by | The user name of the administrator who updated the CI or relationship properties. |

| GUI Element (A-Z) | Description |
|--------------------|---|
| Update Time | The date and time when the CI or relationship properties were last updated. |
| User Label | Enables you to define a display label for the CI or relationship. If no value is entered, the CI name appears as the default label. |



Context Menu

| Menu Item | Description |
|----------------------------|--|
| Copy Property Name | Copies the name of the selected property to the memory. |
| Copy Property Value | Copies the value of the selected property to the memory. |

Discovery and Changes Summary Dialog Box

| | |
|------------------------------|--|
| Description | <p>Enables you to find recent changes, for example, to an application, by rediscovering the CIs and jobs in a view.</p> <p>To access: In IT Universe Manager:</p> <ul style="list-style-type: none"> ▶ To rediscover all CIs of a view, click the Show Discovery and Changes Summary button  in the CI Selector toolbar. The Discovery and Changes Summary dialog box is displayed. ▶ To rediscover one CI or several CIs in a view, select the CI and display the Discovery tab. <p>To rediscover CIs, you can also select Operations > Show Discovery and Changes Summary.</p> |
| Important Information | <p>By default, you can run the rediscovery procedure on views that include less than 10,000 CIs.</p> <p>To increase the number of CIs that you can rediscover in a view:</p> <ol style="list-style-type: none"> 1 Access the Infrastructure Settings Manager (Settings > Infrastructure Settings Manager). 2 Select the Foundations context, choose Discovery and Dependency Mapping from the list, and locate the Max CIs in view supported to rediscover entry. 3 Click the Edit button and change the number. 4 Restart the server for the change to take effect. <p>For details on working with the Infrastructure Settings Manager, see Chapter 14, “Infrastructure Settings Manager”.</p> |
| Included in Tasks | <p>“Check Status of Application Discovery (Rediscover a View)” on page 46</p> |
| Useful Links | <p>“Discovery Status Pane” in <i>Discovery and Dependency Mapping Guide</i></p> |

The following elements are included (unlabeled GUI elements are shown in angle brackets>):

| GUI Element (A-Z) | Description |
|---|---|
|  | Click to refresh the status of the selected CIs. This button is disabled when there is no data to be reloaded. |
|  | Click to rerun the discovery. |
| Discovery Progress Status on View | For details, see “Discovery Status Pane” in <i>Discovery and Dependency Mapping Guide</i> . |
| History Changes on View | For details, see “CI/Relationship History Dialog Box” on page 51. |

Get Related CIs Report

| | |
|------------------------------|---|
| Description | Enables you to view the CIs related to a specified CI in a tree format. To access: In IT Universe Manager, click Generate Related CIs Report  from the toolbar. |
| Important Information | <ul style="list-style-type: none"> ➤ For information about limitations on the size of reports produced in .pdf format, see “Troubleshooting and Limitations” in <i>Reference Information</i>. ➤ For details on how to work with reports, see “Working in Reports - Overview” in <i>Reference Information</i>. |

The following elements are included (unlabeled GUI elements are shown in angle brackets>):



| GUI Element (A–Z) | Description |
|--------------------|--|
| <Related CIs data> | The report data consists of the CIs related to the selected CI, arranged in tree format with the selected CI as the root. The child CIs are arranged by CIT. |
| Generate | Click the Generate button to generate the data for the selected period. |

Insert Relationship Dialog Box

| | |
|------------------------------|---|
| Description | <p>Enables you to attach CIs to the CI you selected in View Explorer.</p> <p>To access: In IT Universe Manager, right-click a CI in the Topology Map or View Explorer, and select Relate to CI from the context menu.</p> |
| Important Information | <p>To create a relationship between two CIs, select the source CI in View Explorer or the Topology Map and then select Relate to CI from the context menu. On the first page of the dialog box (the CI Selection page), you select the target CI(s). Then click Relationship, to select the relationship type on the second page of the dialog box.</p> <p>You can also create a relationship between two CIs graphically by clicking the Create Relationship button  in the toolbar and drawing a line between the two CIs. In this case, a smaller version of the Insert Relationship dialog box opens, which contains the following tabs:</p> <ul style="list-style-type: none"> ➤ Select Relationship. Displays a tree with the available relationship types. Select the required relationship. <ul style="list-style-type: none"> Note: You can double-click the relationship you select to save using the default properties. ➤ Relationship Properties. Displays the properties of the selected relationship. You can edit the properties as described in “Define Relationship Properties Pane” on page 63. |

| | |
|--------------------------|---|
| Included in Tasks | “Create CIs and Relationships in the CMDB” on page 45 |
| Useful Links | “View Explorer” on page 676 |

The following elements are included (unlabeled GUI elements are shown in angle brackets>):

| GUI Element (A–Z) | Description |
|---|---|
|  | Click to add the selected CIs in the left pane to the Target CIs pane. |
|  | Click to remove selected CIs from the Target CIs pane (this does not delete the CIs from the CMDB). |
| Select target CIs | Select a view to display in the view tree and select CIs to move to the Target CIs pane. The Select target CIs pane follows the standard View Explorer functionality. For details, see “View Explorer” on page 676. |
| Source CI | The CI you selected as the source CI. |
| Target CIs | Displays the CIs you have selected as target CIs for the relationship. |

Relationship Page

| | |
|------------------------------|---|
| Description | Enables you to define the relationship to be created between the original CI and the CIs selected in the CI Selection page of the dialog box. To access: Click the Relationship button from the Insert Relationship dialog box. |
| Important Information | When defining multiple relationships, you can define different descriptions and property values for each relationship: Skip the property definitions here and edit each relationship individually after it is created. |

The following elements are included (unlabeled GUI elements are shown in angle brackets>):

Select Relationship Pane

| GUI Element (A–Z) | Description |
|---------------------|---|
| Direction | Select the direction of the relationship. For some relationship types (for example, Container link , or between a group CI and a monitor CI), only one direction is valid. |
| Relationship | Define the type of relationship created between the original CI and the CIs being attached. Select an option from the list. For most relationships, only the Depends On option or the Monitored By option is available, depending on the type of CIs for which you are creating a relationship. |
| Source CI | Displays the name of the CI on the first end of the relationship. This is the CI that you selected in the view. |
| Target CI | Displays the name of the CI on the second end of the relationship, that is attached to the original CI. |

Define Relationship Properties Pane

| GUI Element (A–Z) | Description |
|----------------------------------|---|
| Actual Deletion Period | The period after which the relationship is deleted when the aging mechanism is enabled. |
| Allow CI Update | When the value is set to true, the DDM process automatically updates the relationship. |
| Created By | The user name of the administrator who manually created the relationship, where applicable. |
| Create Time | The date and time when the relationship was created. |
| Deletion Candidate Period | The number of days after which the relationship becomes a candidate for deletion. |
| Description | A detailed description of the relationship. |

| GUI Element (A–Z) | Description |
|------------------------------------|--|
| Destination Network Address | Defined only for route links. Indicates the destination network address to which this route is configured. |
| Enable Aging | <p>If a CI or relationship is not updated or refreshed over a period of time (for example, a CI is not rediscovered by DDM and no manual update occurs), an aging mechanism deletes the CI from the CMDB. For details, see “The Aging Mechanism – Overview” on page 536.</p> <p>True: the aging mechanism is enabled for this CI.</p> <p>Default value: false. The default value for DDM CIs is true.</p> <p>Note:</p> <ul style="list-style-type: none"> ▶ If the aging mechanism is disabled, this field is ignored. ▶ This field is displayed for certain CIs only. |
| Last Access Time | <p>The time that the relationship was last accessed, whether when being updated or being discovered by DDM. This field is only displayed for certain relationships.</p> <p>This parameter is used by the aging mechanism. For details, see “The Aging Mechanism – Overview” on page 536.</p> |
| Must | <p>When the value is set to true, the child CI is dominant when the percentage rule is used to calculate status for the parent CI. If the CI has low status, the parent must take the child CI status, if necessary overriding the percentage rule calculation. This is useful to give emphasis to an important CI. For example, you might want to define Must for a database CI, so that status is critical all the way up the subtree if the database falls, regardless of the status of the other CIs in the subtree.</p> <p>The must status defined for a relationship applies for that relationship only – it is not used in any other relationships of the child CI.</p> |
| Name | A brief description of the relationship. If no value is entered, the relationship type is used in place of the name. |
| Note | Enables you to enter other information about the relationship. |

| GUI Element (A–Z) | Description |
|--------------------|---|
| Origin | An ID for the source that automatically created the relationship, or the application where the relationship was created. |
| Updated By | The user name of the administrator who updated the CI properties. |
| Update Time | The date and time when the relationship properties were last updated. |
| User Label | Enables you to define a display label for the relationship. If no value is entered, the relationship name appears as the default label. |
| Weight | <p>When a weight value is entered, the child CI is given more weight in percentage calculations, when percentage rule is used to calculate status for the parent CI. For example, if a child CI is given a weight of 3, then it has three times more impact on the parent status calculation than its unweighted siblings.</p> <p>The weight defined for a relationship applies for that relationship only – it is not used in any other relationships the child CI may have.</p> |



IT Universe Manager Window



| | |
|-------------------------------------|--|
| <p>Description</p> | <p>Enables you to define and manage the CIs and relationships in your views.</p> <p>The IT Universe Manager window contains the following panes:</p> <ul style="list-style-type: none"> ▶ View Explorer (CI Selector). Displays the CIs of a selected view. You can select the view from a drop-down list. For details, see “View Explorer” on page 676. ▶ Topology Map. Displays the CIs of a selected view in Map mode or Text mode. ▶ Advanced Pane. Displays properties, history, and discovery data for the selected CI or view. <p>To access: Select Admin > Modeling > IT Universe Manager.</p> |
| <p>Important Information</p> | <p>When working in a view in IT Universe Manager, you can create new CIs, modify existing CIs, or delete CIs. All of these actions have a direct effect on the entire IT Universe model. For example, if you delete a CI in your view, that CI is deleted from the IT Universe model and no longer appears in any view.</p> |
| <p>Useful Links</p> | <ul style="list-style-type: none"> ▶ “Save Snapshot Dialog Box” on page 531 ▶ “Set View Parameters/Set View Element Parameters Dialog Box” on page 163 |

Topology Map

| | |
|------------------------------|---|
| Description | <p>Displays the CIs of the currently selected view in graphical or table format. By default, the CIs are displayed in graphical format.</p> <ul style="list-style-type: none">▶ Select the Map Mode tab to display the CIs in graphical format.▶ Select the Text Mode tab to display the CIs in tabular format. <p>To access: Select Admin > Modeling > IT Universe Manager.</p> |
| Important Information | <p>When you select a CI in View Explorer or the Topology Map, the Configuration Items drop-down in the Main Menu becomes active. The options available under that drop-down are the same as those available by right-clicking the CI.</p> <p>You can customize the Topology Map context menu to include other commands (for example, ping, run a program, open a URL) from within CI Type Manager. For details, see “Create Configuration Item Type/Relationship/Calculated Relationship Wizard” on page 226.</p> <p>Note: For grouped CIs and the relationships between them, not all of the context menu options are active. Grouped CIs appear in parentheses in View Explorer and in the Topology Map. You can double-click a link to a grouped CI to open the Link Map, which displays the individual CIs and relationships. Right-click a CI or relationship in the Link Map to display the regular context menu. For details about grouping CIs, see “Node/Relationship Grouping Dialog Box” on page 159.</p> |

The following elements are included (unlabeled GUI elements are shown in angle brackets>):

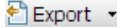
| GUI Element (A-Z) | Description |
|---|---|
|  | <p>Select the topology map mode from the Show window in the toolbar.</p> <p>Note: You can also select the modes from the Operations drop-down in the Main Menu.</p> <p>The following modes are available:</p> <ul style="list-style-type: none"> ▶ View Results. Displays an entire layer within a view. ▶ Related in View. Displays the interdependencies of the selected CI within the current view. ▶ Related in DB. Displays the interdependencies of the selected CI within the entire CMDB. |
|  | <p>Specify the CIT you want displayed in the table. The table also includes the children of the selected CIT.</p> <p>Note: This option is displayed in Text mode only.</p> |

| GUI Element (A–Z) | Description |
|---|--|
|  | <p>Choose the export format for the table data. The available options are:</p> <ul style="list-style-type: none"> ▶ Excel. The table data is formatted as an .xls (Excel) file that can be displayed in a spreadsheet. ▶ PDF. The table data is exported in PDF format. ▶ RTF. The table data is exported in Rich Text Format. ▶ CSV. The table data is formatted as a comma-separated values (CSV) text file that can be displayed in a spreadsheet. <p>Note: For the CSV formatted table data to display correctly, the comma (,) must be defined as the list separator. In Windows, to verify or modify the list separator value, open Regional Options from the Control Panel, and on the Numbers tab ensure that the comma is defined as the List Separator value. In Solaris, you can specify the list separator in the application that opens the CSV file.</p> <ul style="list-style-type: none"> ▶ XML. The table data is formatted as an XML file that can be opened in a text or XML editor. <p>Tip: To extract HTML code from the report:</p> <ul style="list-style-type: none"> ▶ Save the file as HTML ▶ Open the file in an HTML editor ▶ Copy the relevant table into the target file <p>Note: This option is displayed in Text mode only.</p> |
| <Main Menu> | For details, see “Main Menu” on page 713. |
| <Node> | <p>The nodes in the topology map represent CIs.</p> <p>Hold the pointer over a node to display its tooltip which describes the type of the CI.</p> |
| <Relationship> | <p>The links in the topology map represent relationships.</p> <p>Hold the pointer over a relationship to display its tooltip, which describes the type of the relationship.</p> <p>Note: When you select a calculated relationship, the Delete  button in the toolbar is disabled.</p> |

| GUI Element (A-Z) | Description |
|----------------------|---|
| <Toolbar> | <p>For details, see “Toolbar Options” on page 717.</p> <p>Note: When accessing the Topology map via direct links, the toolbar includes options from the Related CIs Map. For details, see “Related CIs in View/Database Map” on page 80.</p> |
| <CI type attributes> | <p>The columns appearing in Text mode represent the CIT attributes of the selected CIs.</p> |
| Map Mode | <p>Click the Map Mode tab to display the selected layer of CIs in topology map format.</p> |
| Text Mode | <p>Click the Text Mode tab to display the attribute properties of the CIs in the selected layer in table format.</p> <p>For details on some of the toolbar icons in Text Mode, see “Element Instances Dialog Box” on page 368.</p> |

IT Universe Manager Context Menu

The IT Universe Manager window includes the following elements (listed alphabetically) available by right-clicking a CI or relationship in the View Explorer pane, Topology Map, or CI Lifecycle page:

| Menu Item | Description |
|-----------------------------------|---|
| Actions | Select one of the following options: <ul style="list-style-type: none"> ▶ Add CI to Discovery Job. Displays the Add CI to Discovery Job dialog box, which enables you to manually invoke a DDM job for the selected CI. You can use this option to discover additional information about the CI through one of the available DDM jobs. ▶ Remove CI from Discovery Job. Displays the Remove CI from Discovery Job dialog box, which enables you to manually remove a CI from the DDM job. ▶ Open Credentials Information. Displays the Protocol Parameters dialog box, which enables you to enter credentials for the selected CI. This option is only relevant for CIs that require credentials to be viewed. For details, see “Domain Credential References” in <i>Discovery and Dependency Mapping Guide</i>. ▶ Show Discovery status. Opens the Discovery Status dialog box for the selected CI. |
| CI/Relationship History | Displays the CI History dialog box. For details, see “CI/Relationship History Dialog Box” on page 51. |
| Delete from CMDB | Enables you to delete the selected CI or relationship from the view and from the CMDB. <p>Note: When you delete a parent CI, the selected CI and its children are removed from the view, but only the selected CI is removed from the database.</p> |
| Generate Direct Link to CI | Enables you to create a direct link to the selected CI using the Direct Links Wizard. For details, see “Generate Direct Link Dialog Box” on page 414. |

| Menu Item | Description |
|------------------------|---|
| Get Related CIs | <p>The following options are available:</p> <ul style="list-style-type: none"> ➤ From View. Opens the Related CIs in View Map. ➤ From Database without Filter. Opens the Related CIs in Database without Filter Map. ➤ From Database with Filter. Opens a dialog box that displays the number of related CIs by type. Select the CI type you want to display in the Related CIs Map and click OK. ➤ Reveal From Database without Filter. Adds to the existing map the immediate neighbors of the selected CI in the CMDB. This option is only active within the Related in DB mode of the Topology Map. ➤ Reveal From Database with Filter. Opens a dialog box which displays the number of related CIs by type. Select the CI type you want to display in the Topology Map results. Adds to the existing map the immediate neighbors of the selected CI that match the CI type selected. This option is only active within the Related in DB mode of the Topology Map. ➤ Reveal from View. Adds to the existing map the immediate neighbors of the selected CI in the view. This option is only active within the Related in View mode of the Topology Map. |
| Label | <p>Select one of the following options:</p> <ul style="list-style-type: none"> ➤ Edit Label. Opens the Edit Label dialog box which enables you to edit the name of the CI. ➤ Restore Default Label. Resets the CI name to its default value from the CMDB. |
| Note | <p>Select one of the following options:</p> <ul style="list-style-type: none"> ➤ Add Note. Opens an editing box where you can add a note to the CI. ➤ Delete Note. Deletes all text saved in a note for the selected CI. |
| Open | <p>Appears only for configuration file CIs. Opens the configuration file in a popup window.</p> |

| Menu Item | Description |
|---------------------------|--|
| Properties | Displays the Properties page for the selected CI or relationship. For details, see “Configuration Item Properties Dialog Box” on page 53. |
| Relate to CI | Opens the Insert Relationship dialog box. For details, see “Insert Relationship Dialog Box” on page 61. |
| Show Compound Path | Appears only for compound relationships. Displays the Link Map for the selected relationship, which shows the CIs involved in the compound relationship. |
| Show Differences | Appears only for configuration file CIs. When two such CIs are selected, the option is active. Displays the differences between the two configuration files in a popup window. For details, see “CI/Relationship History Dialog Box” on page 51. |
| Straighten | Straightens the relationship between two nodes. This option is only available for relationships that have angles. |
| View Sublayer | Displays a popup window showing the CIs in the layer beneath the selected CI. Note: This option is only active for CIs with children. |



Advanced Pane

The following elements are included (unlabeled GUI elements are shown in angle brackets>):

| GUI Element (A–Z) | Description |
|----------------------|---|
| Discovery tab | Displays the DDM run status for the selected CIs. For details, see “Discovery and Changes Summary Dialog Box” on page 59 and “Discovery Status Pane” in <i>Discovery and Dependency Mapping Guide</i> . |

| GUI Element (A–Z) | Description |
|-----------------------|--|
| History tab | Displays the history for the selected CI. For details, see “CI/Relationship History Dialog Box” on page 51. |
| Properties tab | Displays the selected CI’s properties (the same properties that appear in the Configuration Item Properties dialog box). You can view the properties in the properties tab, but you must open the dialog box to edit the properties. For details, see “Configuration Item Properties Dialog Box” on page 53. |

New CI Dialog Box

| | |
|------------------------------|--|
| Description | <p>Enables you to define a new CI.</p> <p>To access: In IT Universe Manager, click the New CI icon  in the toolbar to create a non-related CI. Select a CI in the topology map and click the New Related CI icon  to create a related CI.</p> |
| Important Information | <p>To define a new CI, select the CI type from the tree at the top of the dialog box. The CI types in the tree that are available to be instantiated appear in black. The CI types in faded text cannot be instantiated.</p> <p>Edit the properties in the Define new CI properties area. The table below includes the properties which are common to all CIs. In addition, there are other properties specific to each CI.</p> <p>If you are creating a related CI, click the Relationship button to go to the relationship mode of the dialog box. Select a relationship and edit its properties.</p> |
| Included in Tasks | “Create CIs and Relationships in the CMDB” on page 45 |
| Useful Links | “View Explorer” on page 676 Chapter 22, “CI Lifecycle and the Aging Mechanism” |

The following elements are included (unlabeled GUI elements are shown in angle brackets>):

| GUI Element (A–Z) | Description |
|----------------------------------|--|
| Actual Deletion Period | The period after which the CI is deleted when the aging mechanism is enabled. |
| Allow CI Update | When the value is set to true, this option enables the DDM process to automatically update the CI properties with information that it discovers. If you change the value of a property supplied by the DDM process, the value is overridden by the discovered value. When the value is set to false, the CI properties are not overridden by the DDM process. |
| City | The name of the city. The list is automatically updated when you select a country (or state, when applicable). Select an option from the list. |
| Country | The country in which the CI is located. Select an option from the list. |
| Created By | The user name of the administrator who manually created the CI, where applicable. |
| Create Time | The date and time when the CI was created. |
| Deletion Candidate Period | The period after which the CI becomes a candidate for deletion when the aging mechanism is enabled. |
| Description | A description of the CI. |
| Display Label | The label that appears for the CI in the topology map. |

| GUI Element (A–Z) | Description |
|-------------------------|--|
| Enable Aging | <p>If a CI or relationship is not updated or refreshed over a period of time (for example, a CI is not rediscovered by DDM and no manual update occurs), an aging mechanism deletes the CI from the CMDB. For details, see “The Aging Mechanism – Overview” on page 536.</p> <p>True: the aging mechanism is enabled for this CI.</p> <p>Default value: false. The default value for DDM CIs is true.</p> <p>Note:</p> <ul style="list-style-type: none"> ▶ If the aging mechanism is disabled, this field is ignored. ▶ This field is displayed for certain CIs only. |
| Last Access Time | <p>The time that the CI or relationship was last accessed, whether when being updated or being discovered by DDM. This field is only displayed for certain CIs or relationships.</p> <p>This parameter is used by the aging mechanism. For details, see “The Aging Mechanism – Overview” on page 536.</p> |
| Name | The name of the CI. |
| Note | Enables you to enter other information about the CI. |
| Origin | An ID for the source that automatically created the CI, or the application where the CI was created. |
| Relationship | For a related CI, click Relationship to go to the relationship mode of the dialog box. |
| State | The name of the state – when applicable for the selected country. The list is automatically updated when you select a country. Select an option from the list. |
| Select CI Type | <p>Enables you to select the CI type from the tree for the new CI. The CI types that are available for the selected CI or view appear active in the CI type tree. The other CI types appear in faded text and cannot be selected.</p> <p>To limit the CI type tree to CI types from the current view, select CI Types from the current view on the right. To display all CI types in the tree, select All CI Types.</p> |
| Updated By | The user name of the administrator who updated the CI properties. |

| GUI Element (A–Z) | Description |
|--------------------|---|
| Update Time | The date and time when the CI properties were last updated. |
| User Label | Enables you to define a display label for the CI. If no value is entered, the CI name appears as the default label. |

Relationship Dialog Box

| | |
|--------------------|---|
| Description | <p>Enables you to define the relationship between the new CI and the CI selected in the view, as well as the properties of the relationship.</p> <p>To access: Click the Relationship button from the New Related CI dialog box.</p> |
|--------------------|---|

The following elements are included (unlabeled GUI elements are shown in angle brackets>):

| GUI Element (A–Z) | Description |
|------------------------|---|
| Allow CI Update | When the value is set to true, the DDM process automatically updates the relationship. |
| CI Definition | Click CI Definition to return to the CI properties mode of the dialog box. |
| Created By | The user name of the administrator who manually created the relationship, where applicable. |
| Create Time | The date and time when the relationship was created. |
| Description | A description of the relationship. |
| Direction | Select the relationship direction from the drop-down box. |







| GUI Element (A–Z) | Description |
|-------------------------|--|
| Enable Aging | <p>If a CI or relationship is not updated or refreshed over a period of time (for example, a CI is not rediscovered by DDM and no manual update occurs), an aging mechanism deletes the CI from the CMDB. For details, see “The Aging Mechanism – Overview” on page 536.</p> <p>True: the aging mechanism is enabled for this CI.</p> <p>Default value: false. The default value for DDM CIs is true.</p> <p>Note:</p> <ul style="list-style-type: none"> ▶ If the aging mechanism is disabled, this field is ignored. ▶ This field is displayed for certain CIs only. |
| Last Access Time | <p>The time that the relationship was last accessed, whether when being updated or being discovered by DDM. This field is only displayed for certain relationships.</p> <p>This parameter is used by the aging mechanism. For details, see “The Aging Mechanism – Overview” on page 536.</p> |
| Must | <p>When the value is set to true, the child CI is dominant when the percentage rule is used to calculate status for the parent CI. If the CI has low status, the parent must take the child CI status, overriding the percentage rule calculation if necessary. This is useful to give emphasis to an important CI. For example, you might want to define Must for a database CI, so that status is critical all the way up the subtree if the database falls, regardless of the status of the other CIs in the subtree.</p> <p>The Must status defined for a relationship applies to that relationship only – it is not used in any other relationships of the child CI.</p> |
| Name | The name of the CI. |
| Network Address | Defined only for route links. Indicates the destination network address to which this route is configured. |
| Note | Enables you to enter other information about the CI. |
| Origin | An ID for the source that automatically created the relationship, or the application where the relationship was created. |







| GUI Element (A–Z) | Description |
|---------------------|--|
| Relationship | Enables you to define the type of relationship that is created between the two CIs. For most relationships, only the Depends On option is available. |
| Source CI | The name of the CI on the first side of the relationship. This is the CI that you selected in the view. |
| Target CI | The name of the CI on the second side of the relationship. This is the new CI that you are creating. |
| Updated By | The user name of the administrator who updated the relationship properties. |
| Update Time | The date and time when the CI properties were last updated. |
| User Label | Enables you to define a display label for the relationship. |
| Weight | <p>When a weight value is entered, the child CI is given more weight in percentage calculations, when the percentage rule is used to calculate status for the parent CI. For example, if a child CI is given a weight of 3, then it has three times more impact on the parent status calculation than its unweighted siblings.</p> <p>The weight defined for a relationship applies to that relationship only – it is not used in any other relationships of the child CI.</p> |







Related CIs in View/Database Map

| | |
|------------------------------|--|
| Description | <p>Enables you to view the CIs related to a specified CI in the view or the CMDB in map or table format.</p> <p>To access: In IT Universe Manager, right-click the required CI and select Get Related CIs > From View or From Database with Filter or From Database without Filter.</p> |
| Important Information | <p>When you select From View, the Related CIs Map displays related CIs in the current view. When you select From Database without Filter, the Related CIs Map displays related CIs in the CMDB. When you select From Database with Filter, you first select the CI types you want to see in the map, which then displays related CIs of those types in the CMDB.</p> <p>The related CIs can be viewed in map mode or in text mode. The text mode format of the map includes the icons found in the Element Instances dialog box. For details, see “Element Instances Dialog Box” on page 368.</p> |

The following elements are included (unlabeled GUI elements are shown in angle brackets>):

| GUI Element (A–Z) | Description |
|---|---|
|  | Click Place in Center to place the map in the center of the window. |
|  | Click Fit to Window to fit the map to the size of the window. |
|  | Click Export Map to Image to save the map to a file. |
|  | Click Print... to open the Print Preview dialog box, which enables you to preview or print the map. |
|  | Click Layout Properties to open the Layout Properties dialog box which enables you to modify the layout. |
|  | Click CI Properties to open the Configuration Item Properties dialog box. |

| GUI Element (A–Z) | Description |
|---|--|
|  | Click CI History to open the CI History dialog box for the selected CI. |
|  | Select a different CI in the map and click Reveal from Database without Filter to add the related CIs in the CMDB for the new CI to the existing map. Note: This option is only available from the Related CIs from Database map. |
|  | Select a different CI in the map and click Reveal from Database with Filter to select the CI types you want to see in the map and add the related CIs in the CMDB for the new CI to the existing map. Note: This option is only available from the Related CIs from Database map. |
|  | Select a different CI in the map and click Reveal from View to add the related CIs in the view for the new CI to the existing map. Note: This option is only available from the Related CIs from View map. |
|  | Select a different CI in the map and click Refocus on CI without Filter to redraw the Related CIs map with the new CI as the focus without using a CI type filter. Note: This option is only available from the Related CIs from Database map. |
|  | Select a different CI in the map and click Refocus on CI with Filter to select the CI types to appear in the Related CIs map and redraw the map with the new CI as the focus. Note: This option is only available from the Related CIs from Database map. |
|  | Select a different CI in the map and click Refocus on CI from View to redraw the Related CIs map with the new CI as the focus. Note: This option is only available from the Related CIs from View map. |

| GUI Element (A–Z) | Description |
|---|--|
|  | Click Reset Focus to restore the focus of the Related CIs map to the original state. |
|  | Click Delete to delete the selected CI or relationship. |
|  | Click New Related CI to open the New Related CI dialog box, which enables you to define a new related CI. For details, see “New CI Dialog Box” on page 74. |
|  | Click Relate to CI to open the Insert Relationship dialog box, which enables you to create a relationship between two CIs. For details, see “Insert Relationship Dialog Box” on page 61. |
|  | Click Add CI to Discovery Job to display the Add CI to Discovery Job dialog box, which enables you to manually invoke a DDM job for the selected CI. You can use this option to discover additional information about the CI through one of the available DDM jobs. |
|  | Click Remove CI from Discovery Job to display the Remove CI from Discovery Job dialog box, which enables you to manually remove a CI from the DDM job. |
| <Layout box> | Select the map layout from the drop-down list. |
| <Mode box> | Select the map mode from the drop-down list. |
| Map | Select Map to view the related CIs in map mode. |
| Text | Select Text to view the related CIs in text mode. |

Context Menu

The Related CIs Map includes the following elements (listed alphabetically) available by right-clicking a CI or relationship in the map:

| Menu Item | Description |
|---|--|
| <p><IT Universe Manager context menu options></p> | <p>The following context menu options from the main IT Universe Manager window are also available in the Related CIs Map:</p> <ul style="list-style-type: none"> ▶ Properties ▶ CI History ▶ Delete ▶ Insert Relationship <p>For details, see “IT Universe Manager Window” on page 66.</p> |
| <p>Get Related CIs > Refocus on CI without Filter</p> | <p>Select a different CI in the map and select Get Related CIs > Refocus on CI without Filter to redraw the Related CIs map with the new CI as the focus.</p> <p>Note: This option is only available from the Related CIs from Database map.</p> |
| <p>Get Related CIs > Refocus on CI with Filter</p> | <p>Select a different CI in the map and select Get Related CIs > Refocus on CI with Filter to select the CI types to appear in the Related CIs map and redraw the map with the new CI as the focus.</p> <p>Note: This option is only available from the Related CIs from Database map.</p> |
| <p>Get Related CIs > Refocus on CI from View</p> | <p>Select a different CI in the map and select Get Related CIs > Refocus on CI from View to redraw the Related CIs map with the new CI as the focus.</p> <p>Note: This option is only available from the Related CIs from View map.</p> |
| <p>Get Related CIs > Reset Focus</p> | <p>Select Reset Focus to restore the focus of the Related CIs map to the original state.</p> |
| <p>New Related CI</p> | <p>Opens the New Related CI dialog box, which enables you to define a new related CI. For details, see “New CI Dialog Box” on page 74.</p> |

3

Modeling Studio

This chapter provides information on the Modeling Studio.

This chapter includes:

Concepts

- ▶ Modeling Studio – Overview on page 86
- ▶ Business CI Models on page 86
- ▶ Building a Perspective Based View on page 88
- ▶ Revealed CIs and Watchpoints on page 90

Tasks

- ▶ Build a Business CI Model on page 94
- ▶ Build a View Based on a Model on page 96
- ▶ Build a View Based on a Collection of CIs on page 96

Reference

- ▶ Modeling Studio User Interface on page 97

Modeling Studio – Overview

The Modeling Studio enables you to create perspective based views, which comprise a subset of the IT universe, containing only those CIs relating to a specific area of interest. Perspective based views are composed of a selection of CIs and a viewing perspective. A perspective is a template which is applied to the CI selection, similar to the pattern in a pattern view. For example, a perspective could comprise a host containing an IP. In that case, the view would include all the hosts in the CI selection along with their contained IPs.

The most basic perspective is known as the Content Only perspective and consists of only the node itself. If you apply the Content Only perspective to a CI collection, the resulting view contains only the selected CIs themselves.

The views created in the Modeling Studio can be viewed in the topology map in IT Universe Manager, like all other views. They also appear in the view tree in the Views pane of View Manager, but do not appear in the editing pane when selected. All editing of perspective based views occurs in the Modeling Studio.

Business CI Models

The collection of CIs which compose the view content can be selected in two ways. You can select CIs from the CI Selector and drag them onto the editing pane. In this case, you can build a view by applying a perspective to the collection and the collection cannot be reused in another view without repeating the selection process. The other way to select the CIs to appear in the view is by creating a model.

A model is a reusable collection of CI instances that define a business entity, such as a business service or line of business. By creating a model, you are building a CI collection that can be reused with other perspectives to create different views. Any changes you subsequently make to the model are reflected in all the views based on that model.

Building a Model

You build a model by first selecting a business CI to serve as its basis. The available business CIs include group, application, business service, business unit, and line of business. Then, you can add CIs to your model in the following ways:

- ▶ Manually, by dragging CIs from the CI Selector into the Model Editor
- ▶ Revealing related CIs using a reveal path and selecting the ones to add to the model
- ▶ Defining a watchpoint for a selected CI and automatically adding CIs to the model

You can also begin building a model by dragging CIs onto the empty canvas and selecting **Create a new model**.

The model you create is a CI itself and the CIs in your model are related to the model by **Contains** relationships. You must save your model before applying a perspective to it to build a view.

Important: The changes you make in a model affect the entire universe, not just the views based on that model. Thus, if you delete a CI from a model, you are deleting the relationship that existed between the CIs from the CMDB.

Building a Perspective Based View

A perspective based view is composed of a perspective applied to a model or a collection of CIs. The perspective is a special type of template which is designed to be applied to a subset of the IT Universe model. Perspectives are defined in View Manager, but perspective based views are built in the Modeling Studio.

The Content pane of the View Editor displays the models or CIs you have selected to serve as the basis of your view. The Perspective pane displays the selected perspective. The Preview pane displays the resulting view based upon your content and perspective selections. When you make a change in the content or perspective selections, the view is updated accordingly in the Preview pane. For details, see “View Editor” on page 122.

This section includes the following topics:

- “Content” on page 88
- “Perspectives” on page 89
- “Including and Excluding Child CIs” on page 89

Content

The content in a perspective based view can be selected in two ways:

- You can add individual CIs to the view manually, using the CI Selector. The CIs in the collection are independent of each other. In this case, the collection of CIs is not defined as a model and cannot be reused in another view.
- You can add one or more models to the view, using the CI Selector. Alternatively, you can start by working with a model in the Model Editor and select Generate View for Selected Model to build a view based on that model. In this case, the identical content can be used to build another view by selecting the same models.

You can select both individual CIs and models to form the content of a perspective based view, however in that case, the models are treated as ordinary CIs. The models themselves are included in the view without their hierarchy of child CIs.

Perspectives

The perspective you select for your view determines which CIs are included in the view. A perspective is a reusable pattern, similar to a template. The difference between a perspective and a regular template is that the perspective includes one or more nodes designated as contact nodes. A contact node is a node in the pattern which is used to apply the pattern to specific content.

For example, in the following perspective, a host is designated as the contact node and it has an IP related to it by a contained relationship.

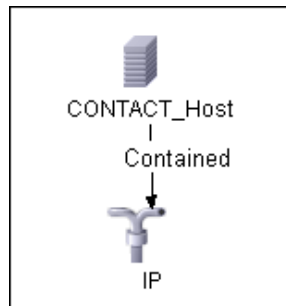

When this perspective is applied to a CI collection, all the hosts in the collection appear in the resulting view, along with the IPs contained in them. The hosts that do not contain IPs, as well as CIs of any other type from the collection, do not appear in the view.

A perspective can have several contact nodes, but every disconnected graph within a perspective must have at least one contact node.

If you make a change to a perspective, all views based on that perspective are affected.

Including and Excluding Child CIs

When adding CIs that have children to a view, the CI and its children are only included in the view if the pattern of the perspective includes children for the selected CI type. In that case, children are included for all CIs of that type. After creating a view, you can hide specific CIs from the view by selecting the CI in the View Results pane and selecting **Hide CI from View** from the context menu or clicking the **Hide CI from View** button in the

toolbar. This option is only available for CIs that were added to the view via the perspective and were not part of the original content on which the view was based. Thus, if the view was based on a collection of CIs, the CIs in that collection cannot be hidden from the view. If the view was based on a model, the model cannot be hidden from the view, but the CIs contained in the model can be hidden.

Revealed CIs and Watchpoints

The Modeling Studio provides two advanced methods of adding CIs to an existing model: revealing related CIs and defining watchpoints.

This section includes the following topics:

- “Revealing CIs” on page 90
- “Watchpoints” on page 93

Revealing CIs

One approach to building a model is to add CIs related to the CIs in the model. The Modeling Studio provides a tool to help you reveal those CIs. The process of revealing related CIs involves constructing a reveal path, which is a chain of CI types that are related to each other. The first item in your reveal path is the CI type of the CI from which you started to reveal CIs. The Modeling Studio locates all of its related CIs and lists their CI types. By selecting one of those types, you build the next step of your path. All the related CIs of that type appear in the lower pane of the dialog box. You can select the ones you want to include in your model. The process is repeated to build the following step of the path.

For example, if you begin to reveal CIs from a CI of type Windows, the Modeling Studio may reveal related CIs of types Interface, Network, and IP. If you select Network, the related CIs of type Network appear in the lower pane and can be added to the model by dragging them into the CIs Basket or clicking the CIs Basket icon:

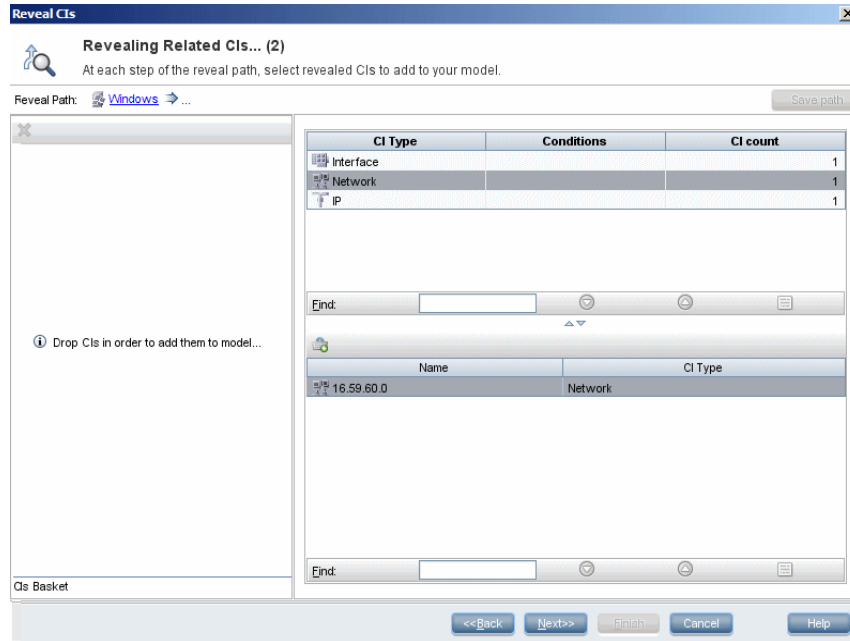

Click **Next** to build the next step of the path using Network as your selection. The Modeling Studio reveals related CIs of type Windows, Unix, and IP. Unix is selected and the Unix CIs appear in the lower pane and can be added to the model by dragging the selected ones into the CIs Basket pane:

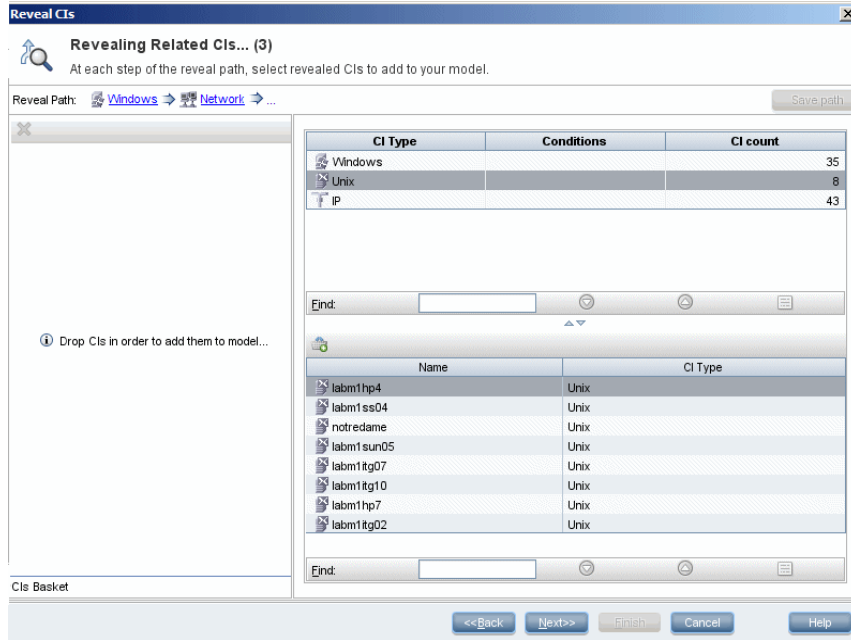

Click **Next** to build the next step of the path using Unix as your selection:

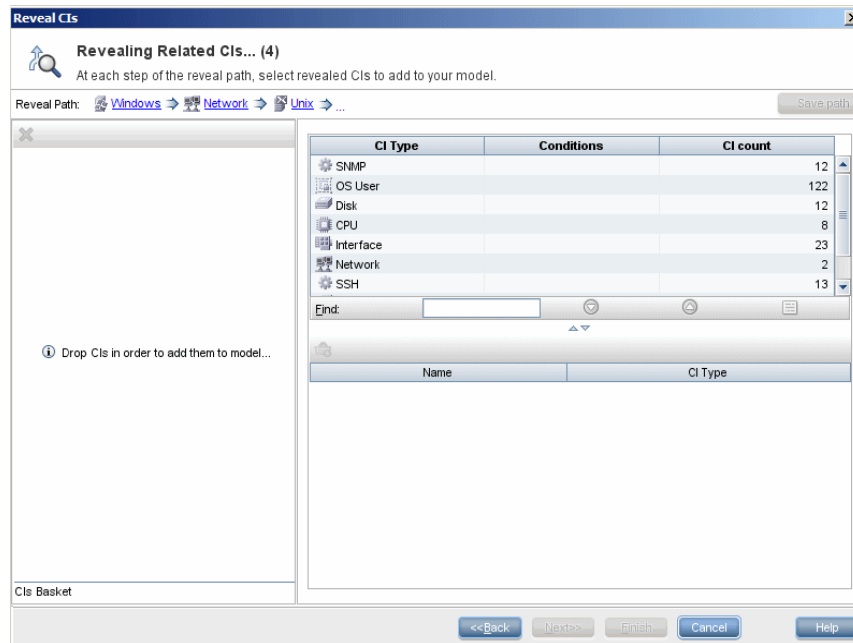

In this case, a reveal path of **Windows > Network > Unix** was constructed. At each step, you have the option of adding any of the revealed related CIs to your model. For details on revealing CIs, see “Reveal CIs Dialog Box” on page 119.

It is also possible to construct a reveal path without revealing CIs. For details, see “Create/Edit/Save Reveal Path Dialog Box” on page 103.

Watchpoints

Another method of locating related CIs to add to the model is by defining a watchpoint for a selected CI in the model. A watchpoint is a mechanism which is triggered when a new related CI of a specified type is created. Every watchpoint is defined in connection with a reveal path. If a new related CI of any CI type included in the path is created, the watchpoint is triggered and an indicator appears next to the model. For details on defining a watchpoint, see “New Watchpoint Dialog Box” on page 115.

Note: You must save a new model before defining watchpoints for its CIs.

All the related CIs detected by the watchpoint are displayed in the Watchpoints Updates dialog box. The dialog box enables you to select the ones to add to your model and the ones to suppress, or exclude from your model. For details, see “Watchpoints Updates Dialog Box” on page 127.

You also have the option to include the detected CIs in your model automatically by selecting the check box in the New Watchpoint dialog box. In this case, all CIs detected by the watchpoint are added to the model.

A watchpoint can also be used to detect CIs included in the model which are no longer related to the model. If such CIs are found along the reveal path connected to the watchpoint, they also appear in the Watchpoints Updates dialog box. You can accept the suggestion to remove the CIs from your model, or you can suppress the suggestion, thereby keeping the CIs in your model.

Note: Although a watchpoint is defined for an individual CI, the watchpoint results display related CIs of the CI types included in the reveal path for all CIs in the model.

Build a Business CI Model

This task describes how to build a business CI model which can serve as the basis for a view.

This task includes the following steps:

- ▶ “Create the New Model” on page 95
- ▶ “Add CIs to the Model Manually” on page 95

- “Reveal CIs” on page 95
- “Define Watchpoints for CIs in the Model” on page 95

1 Create the New Model

In the Modeling Studio, click the **New**  button and select **New Model** to open the New Model dialog box. Select a CI type and enter the values for its properties. For details, see “New Model Dialog Box” on page 114.

2 Add CIs to the Model Manually

In the CI Selector, search for the CIs you want to include in your model. Select them and drag them into the model.

Tip: You can select more than one CI by holding the `CTRL` key while selecting CIs.

3 Reveal CIs

Select a CI in the model and reveal its related CIs along a reveal path. Add selected CIs from among the revealed CIs to your model. When you are done, save the model. For details, see “Reveal CIs Dialog Box” on page 119.

4 Define Watchpoints for CIs in the Model

Right-click a CI in the model and select **Watchpoint > New Watchpoint**. The New Watchpoint dialog box opens. Select a reveal path and click **OK**. A small icon appears next to the CI indicating that a watchpoint is defined for it. For details, see “New Watchpoint Dialog Box” on page 115.

Build a View Based on a Model

This task describes how to build a view in the Modeling Studio based on a model and a perspective.

This task includes the following steps:

- “Open the Model” on page 96
- “Select a Perspective” on page 96
- “Save the View” on page 96

1 Open the Model

In the Modeling Studio, click the **Open**  button and select **Open Model** to open the relevant model. For details, see “Open Model Dialog Box” on page 116.

2 Select a Perspective

In the Model Editor, right-click the model and select **Generate View for selected model**. The Creating New View dialog box opens. Select a perspective to apply to the model. For details, see “Creating New View Dialog Box” on page 104.

3 Save the View

The View Editor opens with your new view. Rename the view and save it in the correct folder. For details, see “View Editor” on page 122.

Build a View Based on a Collection of CIs

This task describes how to build a view in the Modeling Studio based on a collection of CIs and a perspective.

This task includes the following steps:

- “Create the New View” on page 97
- “Add CIs to the View” on page 97

- “Select a Perspective and Save the View” on page 97

1 Create the New View

In the Modeling Studio, click the **New**  button and select **New View** to open the View Editor. For details, see “View Editor” on page 122.

2 Add CIs to the View

In the CI Selector, search for the CIs you want to include in your view. Select them and drag them into the view. For details on the CI Selector, see “View Explorer” on page 676.

Tip: You can select more than one CI by holding the CTRL key while selecting CIs.

3 Select a Perspective and Save the View

In the Perspective pane, select a perspective to apply to your CI collection. Rename the view and save it in the correct folder. For details, see “View Editor” on page 122.

Modeling Studio User Interface

This section describes:

- Choose Operation for Selected Item Dialog Box on page 98
- CI Conditional Search Dialog Box on page 100
- Conditions of Related CIs Dialog Box on page 101
- Create/Edit/Save Reveal Path Dialog Box on page 103
- Creating New View Dialog Box on page 104
- Hidden CIs Dialog Box on page 104

- Manage CI Watchpoints Dialog Box on page 105
- Model Editor on page 106
- Modeling Studio on page 113
- New Model Dialog Box on page 114
- New Watchpoint Dialog Box on page 115
- Open Model Dialog Box on page 116
- Open Saved Reveal Path Dialog Box on page 117
- Open View Dialog Box on page 118
- Reveal CIs Dialog Box on page 119
- Software Elements Search Dialog Box on page 121
- View Editor on page 122
- View Properties Dialog Box on page 126
- Watchpoints Updates Dialog Box on page 127

Choose Operation for Selected Item Dialog Box

| | |
|------------------------------|--|
| Description | Enables you to create models and views from selected CIs. To access: In the Modeling Studio, drag CIs from the CI Selector onto the empty canvas. |
| Important Information | You can drag individual CIs or multiple CIs onto the canvas. You can select ordinary CIs and/or models to drag onto the canvas. Use the CTRL key while selecting CIs to select multiple CIs. |







The following elements are included (unlabeled GUI elements are shown in angle brackets>):

| GUI Element (A-Z) | Description |
|--|---|
| Create a new model | Select to build a model comprising the CIs in your selection. If the CIs you dragged onto the canvas include at least one CI that has no valid links to any of the model CI types, this option is disabled. |
| Create a new view | Select to build a view based on the CI collection formed by your selection. |
| Edit the model of the selected CI | Select to edit the selected model in the Model Editor. Note: This option only appears when a single model is dragged onto the canvas. |

CI Conditional Search Dialog Box

| | |
|--------------------|---|
| Description | Enables you to search for CIs by attribute conditions, by related CIs and by attribute conditions of related CIs. To access: In the CI Selector in the Modeling Studio, click Advanced Search in Search mode and select CI Conditional Search . |
|--------------------|---|

The following elements are included (unlabeled GUI elements are shown in angle brackets>):







| GUI Element (A-Z) | Description |
|---|--|
|  | Click to add an attribute condition. |
|  | Click to delete a selected row. |
|  | Click to move a selected row up. |
|  | Click to move a selected row down. |
|  | Click to display the attribute conditions in a popup window. |
| Attribute Name | Select an attribute from the drop-down list. |
| CI Name | Enter a CI name for which to search. |
| CI Type | Enter the CI type for which to search. |
| Operator | Select an operator from the drop-down list. |
| Related CI Name | Enter the name of a related CI for the search. |
| Related CI Type | Click the ellipsis button  to select a CI type from the tree for a search by related CI. |
| Relationship Type | Click the ellipsis button  to select a relationship from the tree for a search by related CI. |
| Search by CI conditions | Select to run a search for CIs with the specified conditions. |

| GUI Element (A-Z) | Description |
|--|--|
| Search by Related CI conditions | Select to run a search for CIs related to CIs with the specified conditions. |
| Search by Related CI criteria | Select to run a search for CIs related to the specified CIs or CI types. |
| Value | Enter a value for the attribute condition. |

Conditions of Related CIs Dialog Box

| | |
|--------------------|--|
| Description | <p>Enables you to define conditions for the CI types in a reveal path.</p> <p>To access: Click the Add Condition or Edit Condition buttons from the Conditions column of the Reveal CIs dialog box.</p> |
|--------------------|--|

The following elements are included (unlabeled GUI elements are shown in angle brackets>):

| GUI Element (A-Z) | Description |
|---|---|
|  | Add the attribute condition you have defined. |
|  | Delete an attribute condition. |
|  | Move a selected row up. |
|  | Move a selected row down. |
|  | View the condition definition. |
| And/Or | Click inside the And/Or field and select either And or Or to link multiple conditions. |
| Attribute name | Select an attribute from the list. |
|  Brackets | Click inside the Brackets box to display a list of brackets you can use to build more complex, logical statements. |
| Criteria | Contains the attribute condition definition as defined in the Element Instances dialog box. |
| Not | Select NOT if you want the condition statement to do the opposite of what is defined. Note: If you select NOT , query results do not include data from the CI instances that were not assigned a value. For example, your system contains three hosts: Host1 is assigned the value A, Host2 is assigned the value B and Host3 is not assigned a value. You create a query to retrieve all hosts that are equal to A and select NOT ; the results of your query only include Host2 because Host3 is not assigned a value. |
| Operator | Select the required operator. For details, see “Attribute Operator Definitions” on page 346. |
| Value | Enter or select the value of the attribute. The Value options vary according to the attribute type you select. |

Create/Edit/Save Reveal Path Dialog Box

| | |
|--------------------|---|
| Description | <p>Enables you to define a new reveal path or edit an existing path.</p> <p>To access: To define a new reveal path, click the Reveal  button from the Model Editor, and select Create Reveal Path.</p> <p>To edit an existing reveal path, select a path from the Open Saved Reveal Path dialog box and click Edit.</p> <p>To save a reveal path, click Save Path from the Reveal CIs dialog box.</p> |
|--------------------|---|

The following elements are included (unlabeled GUI elements are shown in angle brackets>):

| GUI Element (A-Z) | Description |
|--------------------|---|
| Description | Enter a description of the path. |
| Name | Enter the name of the path. |
| Preview | <p>Opens the Reveal CIs dialog box displaying the related CIs in the path.</p> <p>Note: This button does not appear in the Save Reveal Path dialog box.</p> |
| Reveal Path | <p>Build the path by clicking the  icon to open a dialog box with a CI type tree. Select the CI type for the next item in the path.</p> <p>When you hold the pointer over a reveal path item, the following options are available:</p> <ul style="list-style-type: none"> ▶ Delete. Deletes the item from the reveal path. ▶ Add condition. Opens the Conditions of Related CIs dialog box, which enables you to set conditions for the reveal path item. ▶ Refine Node Type. Opens a CI type tree, which enables you to change the CI type of the reveal path item. |

Creating New View Dialog Box

| | |
|--------------------------|--|
| Description | Enables you to select a perspective to create a view from a model. To access: In the Modeling Studio, right-click a model in the Model Editor, View Editor, or CI Selector and select Generate view for selected Model or click the Generate view for selected model icon  from the Model Editor. |
| Included in Tasks | “Build a View Based on a Model” on page 96 |

The following elements are included (unlabeled GUI elements are shown in angle brackets):

| GUI Element (A-Z) | Description |
|--------------------|--|
| <Perspective list> | Select a perspective from the list to apply to your model. |
| Description | Displays a description of the perspective. |

Hidden CIs Dialog Box

| | |
|--------------------|--|
| Description | Enables you to restore hidden CIs to a view. To access: From the View Editor, click the Show Hidden CIs icon from the toolbar of the View Results pane. |
|--------------------|--|

The following elements are included (unlabeled GUI elements are shown in angle brackets):



| GUI Element (A-Z) | Description |
|-------------------|---|
| <check box> | Select the check boxes for the CIs you want to restore. |
| CI Type | The CI type of the excluded CI. |
| Name | The name of the excluded CI. |
| Restore | Click Restore to include the selected CIs in the view. |

| GUI Element (A-Z) | Description |
|---------------------|--|
| Select All | Click Select All to select all the CIs in the list for inclusion in the view. |
| Unselect All | Click Unselect All to clear the check boxes of all the CIs in the list. |



Manage CI Watchpoints Dialog Box

| | |
|--------------------|---|
| Description | <p>Enables you to add or remove watchpoints for a CI in a model.</p> <p>To access: From within a model in the Model Editor, click the Watchpoint  button and select Manage CI Watchpoints or right-click a CI in the model and select Watchpoint > Manage CI Watchpoints.</p> |
|--------------------|---|

The following elements are included (unlabeled GUI elements are shown in angle brackets>):





| GUI Element (A-Z) | Description |
|---|--|
|  Add | Click to open the New Watchpoint dialog box which enables you to add a new watchpoint. |
|  Remove | Click to delete the selected watchpoint. |
| Automated | A check mark indicates that the new CIs found by the watchpoint are to be added to the view automatically. |
| Source CI | Displays the CI forming the beginning of the reveal path. |
| Watchpoint Name | The name of the reveal path associated with the watchpoint. |
| Watchpoint Path | Displays the reveal path for the watchpoint. |







Model Editor









| | |
|------------------------------|---|
| Description | <p>Enables you to create and edit models.</p> <p>To access: In the Modeling Studio, click the New button  and select New Model to create a new model or click the Open button  and select Open Model to edit an existing model.</p> |
| Important Information | <p>The Model Editor contains the following panes:</p> <ul style="list-style-type: none"> ▶ Content pane. Lists the CIs and models contained in the model. ▶ Information pane. Displays the properties, related CIs and watchpoints for the selected CI or model. <p>You can drag CIs from the CI Selector into the Content pane of an existing model to add them to the model. However, you cannot drag in a CI that is already included in the model.</p> <p>You can drag CIs from the CI Selector into the Related CIs tab of the Information pane provided that the selected source and target CI can be related by one of the triplets that includes an Impacted By (Potentially) relationship.</p> |

Content Pane

The following elements are included (unlabeled GUI elements are shown in angle brackets>):

| GUI Element (A-Z) | Description |
|---|--|
|  | Select Text Mode to display the CIs in a list. Select Map Mode to display the CIs as icons in a diagram. |
|  | Click CI Properties to open the Configuration Item Properties dialog box for the selected CI. |
|  | Click Open selected model in a new tab to open the selected model in a separate Model Editor tab. |
|  | Click New Model to open the New Model dialog box which enables you to define a new model within the existing model. |

| GUI Element (A-Z) | Description |
|---|--|
|  | Click Generate view for selected model to create a view based on the current model. The Creating New View dialog box opens, which enables you to select a perspective to apply. |
|  | Click to remove a selected CI from the model (it remains in the CMDB). |
|  | Click Expand All to expand the model hierarchy. |
|  | Click Collapse All to collapse the model hierarchy. |
|  | Click Reveal for the following options: <ul style="list-style-type: none"> ➤ Start Revealing. Opens the Reveal CIs dialog box. For details, see Reveal CIs dialog box. ➤ Create Reveal Path. Opens the Create Reveal Path dialog box. For details, see Create Reveal Path dialog box. ➤ Open Reveal Path. Opens the Open Saved Reveal Path dialog box. For details, see Open Saved Reveal Path dialog box. |
|  | Click Watchpoint for the following options: <ul style="list-style-type: none"> ➤ Watchpoints Updates. Display the watchpoint results and select CIs to add to the model. For details, see Watchpoints Updates dialog box. ➤ New Watchpoint. Define a new watchpoint for the selected CI. For details, see New Watchpoint dialog box. ➤ Manage CI Watchpoints. Add new watchpoints to the CI or remove existing ones. For details, see Manage CI Watchpoints dialog box. |

| GUI Element (A-Z) | Description |
|---|--|
|  | <p>Click Grouping to group CIs in a group model under a model. Select one of the following options:</p> <ul style="list-style-type: none"> ➤ Insert New Group. Create a new empty group. After creating the group, you can drag CIs into it from the CI Selector, the related CIs tab, or from the model itself. ➤ Join to Group. Select a CI or several CIs in the model and join them to an existing group or form a new group. ➤ Ungroup. Select a group and ungroup it. Its CIs remain directly under the main model. |
|  | <p>Click Find to toggle between displaying and hiding the Find box and arrow controls.</p> <p>Note: This button only appears in Text mode.</p> |
|  | <p>Click to refresh the map and optimize the map layout.</p> <p>Note: This button only appears in Map mode.</p> |
|  | <p>Click Fit to Window to resize the map to fit the size of the window.</p> <p>Note: This button only appears in Map mode.</p> |
|  | <p>Select the functionality of the cursor from the Mode drop-down. The following options are available:</p> <ul style="list-style-type: none"> ➤ Select ➤ Drag Map ➤ Zoom <p>Note: This feature only appears in Map mode.</p> |
|  | <p>Select a CI and click Show External Relationships to display the related CIs for that CI.</p> <p>Note: This button only appears in Map mode.</p> |
|  | <p>Click Hide External Relationships to hide the related CIs.</p> <p>Note: This button only appears in Map mode.</p> |
|  | <p>Indicates that watchpoints are defined for the current CI.</p> |

| GUI Element (A-Z) | Description |
|---|---|
|  | Indicates that the watchpoints have detected new CIs related to the current model. Click it to open the Watchpoints Updates dialog box. |
| CI Type column | Displays the type of each CI in the model. |
| Find | Enter a CI name or a portion of a CI name in the Find box to locate a CI in the model. |
| Find Next | Click to go to the next occurrence of the selected search phrase in the model. |
| Find Previous | Click to go to the previous occurrence of the selected search phrase in the model. |
| Highlight | Click to highlight all occurrences of the search phrase in the model. |
| Name column | Displays the name of each CI in the model. |

Context Menu Options

| Menu Item | Description |
|---|---|
| Fit to Window | Resizes the map to fit the size of the window. Note: This option only appears in Map mode. |
| Generate view for selected model | Select to create a view based on the current model. The Creating New View dialog box opens which enables you to select a perspective to apply. |
| Grouping | Click Grouping to group CIs in a group model under a model. Select one of the following options: <ul style="list-style-type: none"> ▶ Insert New Group. Create a new empty group. After creating the group, you can drag CIs into it from the CI Selector, the related CIs tab, or from the model itself. ▶ Join to Group. Select a CI or several CIs in the model and join them to an existing group or form a new group. ▶ Ungroup. Select a group and ungroup it. Its CIs remain directly under the main model. |

| Menu Item | Description |
|---|---|
| Hide External Relationships | Hides the related CIs from the map. Note: This option only appears in Map mode. |
| Insert New Model | Opens the New Model dialog box which enables you to create a new model within the existing model. |
| Open selected model in a new tab | Opens the selected model in a separate Model Editor tab. |
| Properties | Opens the Configuration Item Properties dialog box for the selected CI. |
| Refresh Layout | Refreshes the map and optimizes the map layout. Note: This option only appears in Map mode. |
| Reveal | The following options are available: <ul style="list-style-type: none"> ▶ Start Revealing. Opens the Reveal CIs dialog box. For details, see Reveal CIs dialog box. ▶ Open Reveal Path. Opens the Open Saved Reveal Path dialog box. For details, see Open Saved Reveal Path dialog box. |
| Remove Selected CI(s) from the Model | Deletes the selected CIs from the model (it remains in the CMDB). |
| Select | Select the functionality of the cursor. The following options are available: <ul style="list-style-type: none"> ▶ Select ▶ Drap Map ▶ Zoom Note: This option only appears in Map mode. |
| Show External Relationships | Displays the related CIs for the selected CI. Note: This option only appears in Map mode. |

| Menu Item | Description |
|-------------------|---|
| Watchpoint | <p>The following options are available:</p> <ul style="list-style-type: none"> ▶ Watchpoints Updates. Display the watchpoint results and select CIs to add to the model. For details, see Watchpoints Updates dialog box. ▶ New Watchpoint. Define a new watchpoint for the selected CI. For details, see New Watchpoint dialog box. ▶ Manage CI Watchpoints. Add new watchpoints to the CI or remove existing ones. For details, see Manage CI Watchpoints dialog box. |
| Zoom | <p>Select the size of the map from the list of percents.</p> <p>Note: This option only appears in Map mode.</p> |



Information Pane - Properties Tab

| | |
|--------------------|--|
| Description | <p>Displays the properties of the selected CI.</p> <p>This pane is identical to the Properties tab of the Information pane in IT Universe Manager. For details, see “Configuration Item Properties Dialog Box” on page 53.</p> |
|--------------------|--|

Information Pane - Related CIs Tab

| | |
|--------------------|---|
| Description | <p>Displays the CIs related to the model by depends on relationships.</p> |
|--------------------|---|

The following elements are included (unlabeled GUI elements are shown in angle brackets>):

| GUI Element (A-Z) | Description |
|---|--|
|  | Click to delete the relationship to the selected CI. |
|  | Click Invert Direction to switch the direction of the relationship for the selected CI. |

| GUI Element (A-Z) | Description |
|-------------------|---|
| <CI list> | Lists the name and CI type of the CIs related to the model by depends on relationships, as well as the direction of the relationship. |
| Filter by | Select a field by which to filter the results and enter the value in the by box. |

Information Pane - Watchpoints Tab

| | |
|--------------------|---|
| Description | Displays the watchpoints defined for the selected CI. |
|--------------------|---|



The following elements are included (unlabeled GUI elements are shown in angle brackets>):



| GUI Element (A-Z) | Description |
|---|---|
|  | Click to open the Manage CI Watchpoints dialog box, which enables you to edit the watchpoint. |
| Automated | Indicates whether the new CIs found by the watchpoint are automatically added to the view. |
| Source CI | Displays the CI forming the beginning of the reveal path. |
| Watchpoint Name | The name of the reveal path associated with the watchpoint. |
| Watchpoint Path | Displays the reveal path of the watchpoint. |

Modeling Studio

| | |
|------------------------------|---|
| Description | <p>Enables you to create and edit models and views.</p> <p>The Modeling Studio window contains the following panes:</p> <ul style="list-style-type: none"> ▶ CI Selector. Enables you to browse views or search for CIs. For details, see “View Explorer” on page 676. ▶ Editor pane. Displays the CIs of a selected view or model. ▶ Information Pane. Displays properties, watchpoints, and related CIs for the selected CI. <p>To access: Select Admin > Modeling > Modeling Studio.</p> |
| Important Information | <p>The Editor pane is a blank canvas before any views or models are opened. When you open a view, the View Editor appears there. When you open a model, the Model Editor appears there. Multiple views and models can be open at the same time, each within a separate tab.</p> |
| Useful Links | Model Editor, View Editor |

The following elements are included (unlabeled GUI elements are shown in angle brackets>):

| GUI Element (A-Z) | Description |
|---|--|
|  | <p>Click the New button to select one of the following options:</p> <ul style="list-style-type: none"> ▶ New Model. To create a new model. ▶ New View. To create a new view. |
|  | <p>Click the Open button to select one of the following options:</p> <ul style="list-style-type: none"> ▶ Open Model. To open an existing model. ▶ Open View. To open an existing view. |
|  | <p>Click Save to save the changes to your view or model.</p> <p>For views, a dialog box opens which enables you to rename your view and save it in the appropriate folder.</p> |

| GUI Element (A-Z) | Description |
|---|--|
|  | Click Undo to reverse the last change you made. |
|  | Click Redo to repeat the last action you took. |
|  | Click Maximize Workspace to toggle between the regular display and a full-screen display of the editor. |
| <Menu> | <p>The following drop-downs are available:</p> <ul style="list-style-type: none"> ▶ Resource. Enables you to create a new view or model, open an existing view or model, and save a view or model. ▶ Edit. Enables you to undo or redo an action. ▶ Tools. Includes the options from the right-click menu in the Editor. ▶ View. Enables you to select the panes to display. |

New Model Dialog Box

| | |
|--------------------------|---|
| Description | <p>Enables you to define a reusable model containing a collection of CIs.</p> <p>To access: Click the New  button and select New Model or drag a CI from the tree in the CI Selector onto the editing pane and select Create a new model.</p> |
| Included in Tasks | “Build a Business CI Model” on page 94 |

The following elements are included (unlabeled GUI elements are shown in angle brackets>):

| GUI Element (A-Z) | Description |
|---------------------------------|--|
| Define new CI Properties | Enter the values for the CI properties. You must enter values for key properties and required properties. The key properties are marked with a key symbol  and the required properties are marked with an asterisk. |
| Select CI Type | Select a CI type from the list to serve as the basis for your model. |

New Watchpoint Dialog Box

| | |
|------------------------------|---|
| Description | Enables you to define a watchpoint for a CI in a model. To access: From within a model in the Model Editor, click the Watchpoint  button and select New Watchpoint or right-click a CI in the model and select Watchpoint > New Watchpoint . |
| Important Information | If no reveal paths are found for the selected CI, no watchpoints can be defined. You cannot define watchpoints for CIs in a new model until you save the model. |
| Included in Tasks | “Build a Business CI Model” on page 94 |

The following elements are included (unlabeled GUI elements are shown in angle brackets>):



| GUI Element (A-Z) | Description |
|---------------------------------------|---|
| Add Revealed CIs automatically | Select to automatically add all revealed CIs from the selected path to the model. |

| GUI Element (A-Z) | Description |
|-------------------------------|---|
| Select Watchpoint reveal path | Select a reveal path from the drop-down list. |
| Show reveal paths for CI type | Select a CI type from the drop-down list. All reveal paths beginning with that CI type appear in the list in the lower drop-down box. |

Open Model Dialog Box

| | |
|-------------------|---|
| Description | Enables you to open an existing reusable model containing a collection of CIs in the Editor pane. To access: Click the Open  button in the Modeling Studio and select Open Model . |
| Included in Tasks | “Build a View Based on a Model” on page 96 |

The following elements are included (unlabeled GUI elements are shown in angle brackets>):

| GUI Element (A-Z) | Description |
|---|---|
|  | Click CI Properties to open the Configuration Item Properties dialog box for the selected model. |
|  | Click Remove model to delete the selected model. |
| CI Type column | Displays the CI types of the existing models. |
| Find | Enter a CI name or a portion of a CI name in the Find box to locate a CI in the list of models. |
| Find Next | Click to go to the next occurrence of the selected search phrase in the list of models. |
| Find Previous | Click to go to the previous occurrence of the selected search phrase in the list of models. |
| Name column | Displays the names of the existing models. |

| GUI Element (A-Z) | Description |
|--------------------------------------|--|
| Pending Watchpoint Updates | A blue triangle indicator  appears in the Pending Watchpoint Updates column if a watchpoint defined for a selected model has found new CIs. |
| Show only models with content | When the check box is selected, only models containing CIs appear in the list. |

Open Saved Reveal Path Dialog Box

| | |
|------------------------------|---|
| Description | Enables you to open an existing path. To access: From within a model in the Model Editor, click the Reveal  button and select Open Reveal Path or right-click a CI in the model and select Reveal > Open Reveal Path . |
| Important Information | After selecting the reveal path you want to use, click Execute . If CIs are found on the selected path, the Reveal CIs dialog box opens for that path. If no CIs are found, a message appears stating that no CIs were found on the path. |

The following elements are included (unlabeled GUI elements are shown in angle brackets>):







| GUI Element (A-Z) | Description |
|---------------------------|---|
| Description column | Displays the descriptions of the existing paths. |
| Edit | Opens the Edit Reveal Path dialog box which enables you to edit the selected path. |
| Execute | Opens the Reveal CIs dialog box for the selected reveal path. |
| Find | Enter a path name or a portion of a path name in the Find box to locate a path in the list. |
| Find Next | Click to go to the next occurrence of the selected search phrase in the list of paths. |



| GUI Element (A-Z) | Description |
|--------------------------------------|---|
| Find Previous | Click to go to the previous occurrence of the selected search phrase in the list of paths. |
| Highlight | Click to highlight all occurrences of the search phrase in the list of paths. |
| Name column | Displays the names of the existing paths. |
| Remove | Deletes the selected path. |
| Show reveal paths for CI type | Select a CI type from the drop-down list. All paths beginning with the selected CI appear in the table below. |

Open View Dialog Box

| | |
|--------------------|---|
| Description | Enables you to open an existing view in the Editor pane. To access: Click the Open  button in the Modeling Studio and select Open View . |
|--------------------|---|

The following elements are included (unlabeled GUI elements are shown in angle brackets>):





| GUI Element (A-Z) | Description |
|---|---|
|  | Click Expand Tree to expand the view tree. |
|  | Click Collapse Tree to collapse the view tree. |
|  | Click Refresh to refresh the view tree. |
|  | Click Delete to delete the view. |
|  | Click Disconnect view from perspective to detach a perspective based view from its template. It becomes a pattern view and is no longer affected by changes made to the perspective. |
|  | Go directly to IT Universe Manager for the current view. |

| GUI Element (A-Z) | Description |
|---|--|
|  | Click to go to the next occurrence of the selected search phrase in the list of views. |
|  | Click to go to the previous occurrence of the selected search phrase in the list of views. |
| <View tree> | Displays the existing views in a tree format. |
| Find | Enter a CI name or a portion of a CI name in the Find box to locate a CI in the list of views. |

Reveal CIs Dialog Box

| | |
|------------------------------|--|
| Description | <p>Enables you to search for CIs related to the CIs in a model and add them to the model.</p> <p>To access: In the Model Editor of the Modeling Studio, select a CI, click the Reveal  button, and select Start Revealing or right-click a CI in the model and select Reveal > Start Revealing.</p> |
| Important Information | <p>The upper pane displays the CI types of the CIs related to the selected CI. The lower pane displays the CIs of the type selected in the upper pane.</p> <p>The first step in the reveal path is the CI type of the CI you began with. When you select a CI type from the list in the upper pane, that CI type becomes the second step in the path. Click Next to display the CI types available for the next step of the path.</p> <p>The number at the top of the box in parentheses indicates the length of the constructed path thus far.</p> |
| Included in Tasks | “Build a Business CI Model” on page 94 |

The following elements are included (unlabeled GUI elements are shown in angle brackets>):

| GUI Element (A-Z) | Description |
|---|---|
|  | Click to delete a selected item from the CIs basket. |
|  | Click to add a selected CI from the lower pane to the CIs basket. |
|  | Click to go to the next occurrence of the selected search phrase in the list of CIs. |
|  | Click to go to the previous occurrence of the selected search phrase in the list of CIs. |
| <Lower pane> | Displays a list of related CIs of the type selected in the upper pane. |
| CI count | Indicates how many related CIs of each type were found. |
| CIs Basket | Displays the related CIs you selected to include in the model. |
| CI Type | Displays a list of CI types of the CIs related to the selected CI. |
| Conditions | A check mark indicates that conditions were defined for the selected CI type. Click the Conditions column for the CI type you want to select and click the Add Condition or Edit Condition button to open the Conditions of Related CIs dialog box. This enables you to define and edit conditions for the CI type. |
| Find | Enter a CI name or a portion of a CI name in the Find box to locate a CI in the list of CIs. |
| Finish | Click Finish when you have finished adding CIs to the CI basket. |
| Next | Click Next to display the CI types available for the next step of the path. |

| GUI Element (A-Z) | Description |
|--------------------|--|
| Reveal Path | <p>Displays the reveal path being constructed.</p> <p>Clicking the blue arrows in the path → displays a drop-down list of the CI types available for the next step of the path.</p> <p>Clicking the CI types in the path displays the following options:</p> <ul style="list-style-type: none"> ▶ Jump to page. Refreshes the table with the available CI types for the selected step of the path. ▶ Edit Condition. Opens the Conditions of Related CIs dialog box. ▶ Delete Selected Item(s). Deletes the selected CI type from the reveal path (the path ends at the previous CI type). |
| Save Path | <p>Opens the Save Reveal Path dialog box which enables you to save the path. This option is only active when a unique reveal path has been constructed.</p> |



Software Elements Search Dialog Box

| | |
|--------------------|--|
| Description | <p>Enables you to search for hosts by the applications running on them and for applications by the host on which they are running.</p> <p>To access: In the CI Selector in the Modeling Studio, click Advanced Search in Search mode and select Software Elements Search.</p> |
|--------------------|--|

The following elements are included (unlabeled GUI elements are shown in angle brackets>):







| GUI Element (A-Z) | Description |
|-------------------------|--|
| Host Name | Enter the name of the host for which you are searching. |
| Search for | Select Software Element or Host . Note: To search for a specific software element running on a specific host, enter a host name, select the required software element and search for it. |
| Software Element | Select a software element from the drop-down list. |

View Editor

| | |
|------------------------------|--|
| Description | Enables you to create and edit views. To access: In the Modeling Studio, click the New button  and select New View to create a new view or drag CIs from the CI Selector onto the blank canvas and select Create new view with selected CIs . Click the Open button  and select Open View to edit an existing view. |
| Important Information | The View Editor contains the following panes: <ul style="list-style-type: none"> ▶ Content pane. Drag CIs and/or models onto this pane to include them in your view. ▶ Perspective pane. Select a perspective to apply to the content to build a view. ▶ View Results pane. Displays a topology map with a preview of the current view. |
| Included in Tasks | “Build a View Based on a Model” on page 96, “Build a View Based on a Collection of CIs” on page 96 |

Content Pane

The following elements are included (unlabeled GUI elements are shown in angle brackets>):

| GUI Element (A-Z) | Description |
|---|--|
|  | Go directly to IT Universe Manager for the current view. |
|  | Click Edit View Properties to open the View Properties dialog box which enables you to set properties for the view. |
|  | Click CI Properties to open the Configuration Item Properties dialog box for the selected CI. |
|  | Click Open selected model in a new tab to open the selected model in a separate Model Editor tab. |
|  | Click Generate view for selected model to create a view based on the selected model. The Creating New View dialog box opens which enables you to select a perspective to apply. |
|  | Click to remove a selected CI from the view. |
|  | Click Find to toggle between displaying and hiding the Find box and arrow controls. |
| CI Type column | Displays the type of each CI in the view. |
| Find | Enter a CI name or a portion of a CI name in the Find box to locate a CI in the view |
| Find Next | Click to go to the next occurrence of the selected search phrase in the view. |
| Find Previous | Click to go to the previous occurrence of the selected search phrase in the view. |
| Highlight | Click to highlight all occurrences of the search phrase in the view. |
| Name column | Displays the name of each CI in the view. |





Context Menu Options

| Menu Item | Description |
|--|---|
| Generate view for selected model | Select to create a view based on the selected model. The Creating New View dialog box opens which enables you to select a perspective to apply. |
| Open selected model in a new tab | Opens the selected model in a separate Model Editor tab. |
| Properties | Opens the Configuration Item Properties dialog box for the selected CI. |
| Remove Selected CI(s) from the View | Deletes the selected CI or model from the view. |

Perspective Pane

| GUI Element (A-Z) | Description |
|-----------------------------------|---|
| Apply Over Model Hierarchy | For views based on models, select the Apply Over Model Hierarchy check box to include the model hierarchy in the view and apply the perspective to the CIs included in the model as well as to the model itself. Clear the check box to exclude the model hierarchy from the view and apply the perspective to the model itself only. In this case, the model is treated as an ordinary CI. Note: This option is disabled for a view based on a collection of CIs or on a model and a collection of CIs. |
| Description | Displays a description of the selected perspective. |
| Name | Click the ellipsis button to select a perspective from the drop-down list. |

View Results Pane

| GUI Element (A-Z) | Description |
|---|---|
|  | <p>Click Hide CI from View to hide the selected CI from the view. This option is only relevant for CIs that were added to the view via the perspective. You cannot hide CIs from the original view content from the view.</p> <p>Note: Hidden CIs can be restored from the Hidden CIs dialog box.</p> |
|  | <p>Click Show Hidden CIs to open the Hidden CIs dialog box which enables you to restore CIs that were hidden from the view manually.</p> |
|  | <p>Click Show tree view to toggle between displaying and hiding a tree layout of the view on the left side of the pane.</p> |
|  | <p>Click Expand preview display to display the preview in a separate window.</p> |
| <p><Topology Map></p> | <p>The topology map in the View Results pane follows the layout of the topology map in IT Universe Manager. For details, see “Topology Map” on page 67.</p> |
| <p><Tree View></p> | <p>The tree view on the left of the View Results pane displays the CIs of the view in tree format. This enables you to easily see the structure of the view and its different layers.</p> |

Context Menu Options

| Menu Item | Description |
|--------------------------|---|
| Hide CI from View | Click to hide the selected CI from the view. This option is only relevant for CIs that were added to the view via the perspective. You cannot hide CIs from the original view content from the view. In the case of a view based on a model, the model cannot be hidden but its CIs can. Note: Hidden CIs can be restored from the Hidden CIs dialog box. |
| Properties | Opens the Configuration Item Properties dialog box for the selected CI. |

View Properties Dialog Box

| | |
|------------------------------|---|
| Description | Enables you to set properties for a view. To access: From within the View Editor, click the Edit View Properties  button. |
| Important Information | The properties set in the perspective definition are the default properties that appear selected in the View Properties dialog box. |

The following elements are included (unlabeled GUI elements are shown in angle brackets>):

| GUI Element (A-Z) | Description |
|--------------------|--|
| Ad Hoc View | When the check box is selected, the view is defined as an Ad-hoc view. An Ad-hoc view is not updated automatically as changes occur in the system. The view is updated only when you schedule an update using the Scheduler. For details, see “Scheduler User Interface” on page 488. |
| Description | Enter a description of the view (optional field). |

| GUI Element (A-Z) | Description |
|----------------------------------|--|
| Merge Identical Instances | When the check box is selected, identical instances that appear on the same layer in this view are automatically merged into one symbol in the editing pane. This helps you remove redundant information and sharpen the view's focus. For details, see "Merge Identical Instances" on page 138. |
| Persistent View | Defines whether you want the selected view to always remain in the system memory. You should use this option only for views that are used frequently. |
| Track Changes | Select to be notified when CIs are added or removed. The changes are tracked in the system by creating daily snapshots of the view. |
| View Name | The name of the view. |

Watchpoints Updates Dialog Box

| | |
|------------------------------|---|
| Description | <p>Displays the changes found in related CIs by a watchpoint defined for a model.</p> <p>To access: From within a model in the Model Editor, click the Watchpoint  button and select Watchpoints Updates or right-click a CI in the model and select Watchpoint > Watchpoints Updates.</p> |
| Important Information | <p>The Watchpoints Updates dialog box indicates any changes found involving the CIs related to the model via the associated reveal path. If a new related CI is found which is not included in the model, the suggested update is an added CI. If a CI in the model is found to no longer be related via the path, the suggested update is a removed CI.</p> <p>This option is only enabled when watchpoints are defined for the model and CIs have been found.</p> |

The following elements are included (unlabeled GUI elements are shown in angle brackets>):

| GUI Element (A-Z) | Description |
|-------------------------------|--|
| Accept | Select the check boxes for the CIs you want to add to your model or remove from your model. |
| Accept All | Click Accept All to apply all the suggested changes to your model. |
| CI | The names of the CIs found by the watchpoint. |
| CI Type | The types of the CIs found by the watchpoint. |
| Clear All | Click Clear All to clear the check boxes for all the found CIs. |
| Restore | Select the check boxes for the CIs in the Suppressed CIs pane that you want to consider for inclusion in your model. |
| Show/Hide Suppressions | Toggle between hiding and displaying the Suppressed CIs pane of the dialog box. |
| Suggested Update | Indicates whether the suggested change is an added CI or a removed CI. |
| Suppress | Select the check boxes for the CIs you want to exclude from your model or leave in your model. |
| Suppress All | Click Suppress All to decline all the suggested changes to your model. |

4

View Manager

This chapter provides information on View Manager.

This chapter includes:

Concepts

- ▶ View Manager Overview on page 130
- ▶ View Formats on page 130
- ▶ Templates and Perspectives on page 131
- ▶ Predefined Folders and Views on page 132
- ▶ Building a Business View on page 133
- ▶ Link Nodes to Application CI on page 134
- ▶ Grouping By Attribute Properties on page 137
- ▶ Merge Identical Instances on page 138

Tasks

- ▶ Create a Parameterized Template on page 139
- ▶ Create a Perspective on page 141
- ▶ Create a Template Based View on page 142
- ▶ Create a Pattern View on page 144

Reference

- ▶ View Manager User Interface on page 145

Troubleshooting and Limitations on page 175

View Manager Overview

View Manager is a tool for creating and managing views. You can create your own views, or work with the out-of-the-box (factory) views provided with your HP Universal CMDB installation.

The IT universe model in the configuration management database can be very large, holding thousands of configuration item (CI)s. A view enables you to build a subset of the overall IT universe model, containing only those CIs relating to a specific area of interest. You can define your own views to display only the information that is relevant to your organization's business needs.

HP Universal CMDB supports three view formats, pattern views, template based views, and perspective based views, which are populated through different processes. For details, see “View Formats” on page 130.

View Formats

HP Universal CMDB supports three view formats, by which to populate your view:

- ▶ **Pattern views** are built from a Topology Query Language (TQL) query that defines the structure of the view. You can create the TQL query as you build the view from within View Manager or based on an existing query. The view displays only those CIs and relationships that satisfy the query definition. When the view is displayed or refreshed, View Manager queries the CMDB for all elements that fit the query, and automatically updates the view with those elements.
- ▶ **Template based views** are based on a TQL query, to which a template is then applied. The template is a reusable view that includes parameters, folding rules, and other settings, which are saved as part of the template. This enables you to build multiple views with the same settings without having to re-enter the setting information. The view displays only those CIs and relationships that satisfy the query definition and the conditions of the template. For details on templates, see “Templates and Perspectives” on page 131.

- **Perspective based views** are built by selecting a collection of individual CIs and applying a special type of template, known as a perspective, to it. Instance views, which no longer exist, are replaced by perspective based views. Perspective based views cannot be viewed or edited in View Manager. When you select a perspective based view in View Manager, you are given the option to open the view in Modeling Studio, where you can edit it. For details, see “Modeling Studio – Overview” on page 86.

You can also create new views by selecting **Save As** from the context menu for an existing view and editing the view contents. You then follow the wizard to save the new view with a unique name.

Templates and Perspectives

The templates and perspectives which are used to build template based and perspective based views, respectively, are also defined and edited in View Manager. You can create a template using the New Template wizard. For details, see “New Template/Template Properties/Save As Template Wizard” on page 151. To create a perspective, use the New Perspective wizard. For details, see “New Perspective/Perspective Properties/Save As Perspective Wizard” on page 148.

Templates allow you to save the folding rules, relationship rules and parameters you have set in your definition. This makes it easier to build more views with the same settings. Any changes made to a template affect all existing views based on that template.

The templates you create in View Manager appear the same as pattern views in the editing pane. The same functionality applies to both pattern views and templates. The difference is that templates are reusable and they do not appear in the view list in IT Universe Manager.

Perspectives are a type of template designed to be applied to a specific collection of CIs. You create and edit perspectives in View Manager, but you can only apply them to content to build a view in the Modeling Studio. Perspective based views appear in the views tree in View Manager, but you must go to the Modeling Studio to edit them. For details, see “Building a Perspective Based View” on page 88.

In summary, the tree in the Views pane of View Manager can include five distinct entities:

- pattern views
- templates
- template based views
- perspectives
- perspective based views

The first four are created and edited in View Manager. Perspective based views are created and edited in the Modeling Studio.

You can filter the tree to select the types of views or templates to display. For details, see “View Manager Window” on page 164.

Predefined Folders and Views

The file folder system in View Manager includes predefined folders and views, as described in the following sections:

- “Predefined Folders” on page 132
- “Factory Views” on page 132
- “Predefined Perspectives” on page 133

Predefined Folders

View Manager contains a hierarchical file folder system to help you organize your views and templates, displayed in the Views pane. Predefined folders are provided for the out-of-the-box views; you can modify these folders, or add additional folders according to your organization’s requirements.

Factory Views

Your HP Universal CMDB installation includes out-of-the-box pattern views, templates, and perspectives. These views provide a quick start for working with the CMDB.

The out-of-the-box views are initially empty. As soon as CIs are added to the CMDB by one of the CI generators, the TQL query built into each pattern view is able to identify the CIs that meet the pattern requirements, and add them to the view.

Views for CIs are created when a discovery process is run; the out-of-the-box views that are provided correspond to the relevant Discovery and Dependency Mapping (DDM) packages. For example, the Oracle view (**Root > Database > Oracle > Oracle**) is populated with CIs that are created when Discovery and Dependency Mapping activates the Database - Oracle module. For details on running DDM, see “Run Discovery – Advanced Mode Workflow” in *Discovery and Dependency Mapping Guide*.

Some of the out-of-the-box views are considered basic to the system and cannot be deleted from the folders.

Predefined Perspectives

HP Universal CMDB also provides out-of-the-box perspectives. One example is the Content Only perspective, which includes only the elements of the view content itself, without any additional CIs.

Building a Business View

You can define your own views in View Manager to model your business environment. These views should provide the business users with logical representations of your company’s structure, processes, and goals.

To meet these requirements, you generally build multiple views representing different aspects of your business; for example, you could build business views that revolve around any of the following:

- Company structure, so that data is organized by the geographical location of branches, or by data centers.
- Business processes, so that data is organized by line of business, or by applications.
- Business goals, so that data is organized by sales, or by key customers.

The views you create depend on the particular demands of your organization and the actual hierarchical structure of the views should reflect those demands.

The usual hierarchical format of a view is as follows:

- ▶ **Top level.** The highest levels of the view, consisting of the root CI and the branches below it, are normally built from logical **Business** CI types such as **Location, Line of Business, Customer, Application**, and so on.
- ▶ **Intermediate level.** The intermediate branches of the view normally consist of **System** CI types, representing actual hardware and software and/or monitoring group CI types, representing groups containing monitors.
- ▶ **Bottom level.** The lowest level of the view, consisting of leaf CIs at the ends of the subtrees, is built from the **Monitor** CI types.

Note: The bottom level is only relevant when a monitoring solution such as HP Business Availability Center is connected and modeled in the CMDB.

Link Nodes to Application CI

HP Universal CMDB enables you to define a node in a view to be linked to all the instances of that CIT in your IT universe. You can use this feature, for example, to show which hosts are serving a specific business service or to create Correlation rules that reflect problems at the business level.

When you select **Add to Applications** from the context menu for a node in View Manager, a new CI of type **application** is created. All instances of the selected node in any corresponding view are then linked to the new CI with **Contains** links. This CI is actually a model of type **application** which can be viewed in the Modeling Studio. The CIs in the model appear in read-only format. For details on models, see “Business CI Models” on page 86.

If you make a change to the existing nodes of a view, such as selecting another node to be linked to the application CI or removing the link from a node to the application CI, the recalculation is performed immediately. However, if you add a node to the view, the recalculation is performed at the next scheduled update.

This functionality can be applied to any CI type except for: IT Universe, Business, Application, and all extended CI types (from running CMDB federation functionality).

This section includes the following topics:

- “Linking a Node to an Application CI” on page 135
- “Removing the Link between a Node and the Application CI” on page 137

Linking a Node to an Application CI

To link a node to an application CI, select a node in the TQL in the editing pane of View Manager. Right-click the node and select **Add to Applications**. A dialog box opens with a default name for the new application CI, which is the name of the view from which you defined it followed by "_Application." You can accept the default name or assign it a name of your choice. The new CI is connected by **Contains** links to all the instances of the node.



A small black briefcase icon appears to the right of the node. The creation of the application CI and the links occurs when you save the view.

If you select a different node and repeat the process, the dialog box does not open (only one application CI is created per view), but **Contains** links are created between that CI and the instances of the second node.

Example

In a view called Oracle, you select a host and click **Add to Applications** from the context menu. A new CI of type application named Oracle_Application is created and all the hosts queried in this TQL are linked to the Oracle_Application CI by Contains links.

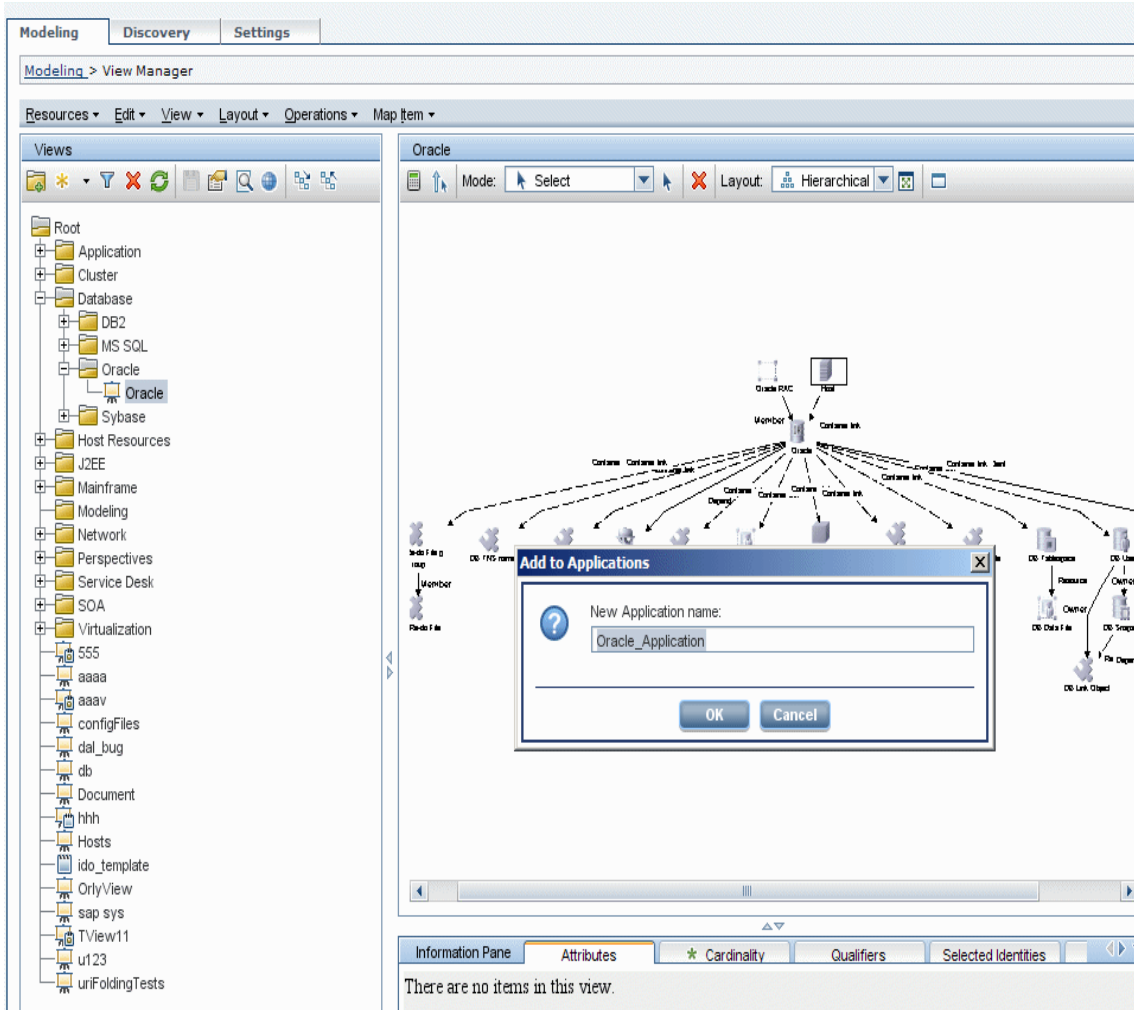

Removing the Link between a Node and the Application CI

To remove the link between a node and the application CI, right-click the node you selected as **Add to Applications**, and select **Remove from Applications**. The briefcase icon disappears and the relationships to the application CI are removed. If there are no remaining nodes in the view selected for linking to the application CI, the application CI itself is deleted. The change takes effect when you save the view. When you delete a view, the application CI created from within the view is also deleted.

Grouping By Attribute Properties

When grouping CIs in View Manager by attribute using **Node Grouping**, you can group CIs of different types in the Topology Map by using a regular expression as described in “Node/Relationship Grouping Dialog Box” on page 159. Enter the expression in the **Mask to group by** field in the Advanced Attribute Properties page of the dialog box. For details about regular expressions, see “Regular Expression Examples” in *Reference Information*.

Nested Groups

You can create nested groups (a node group inside another node group) to help fine-tune the TQL results that are displayed in the Topology Map.

For example, after grouping host nodes by their CIT, you can use their **operation state** attribute to create more focused groups.

Merge Identical Instances

When defining a view, you can have identical instances that appear on the same layer in the view automatically merged into one symbol on the editing pane. This helps you remove redundant information and sharpen the view's focus.

For example, if you want to discover and display hosts that are connected to other hosts in a server-client relationship, you can create the following TQL:

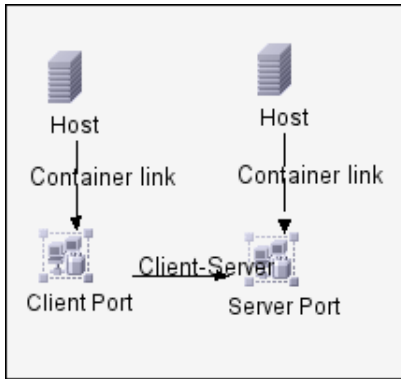

However, if both the server and the client are installed on the same host, one host appears twice.

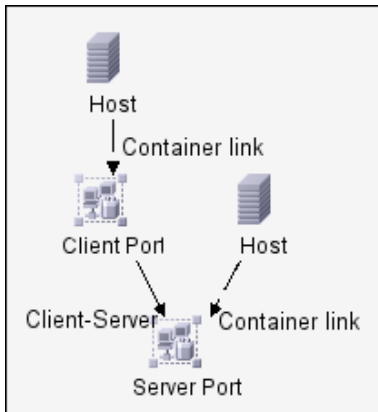

To overcome the redundant host display, you define that identical instances should be merged by selecting **Merge Identical Instances** on the **Advanced Properties** page of the New View wizard:

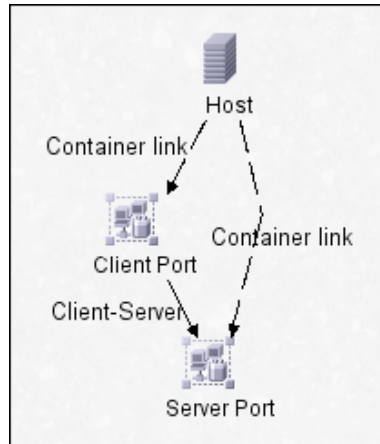

Create a Parameterized Template

This task describes how to define a new parameterized template.

This task includes the following steps:

- “Define a Template” on page 140
- “Define the Base TQL” on page 140
- “Set the Advanced Properties” on page 140
- “Add Nodes and Relationships to a TQL Query” on page 140
- “Add Folding Rules to Relationships” on page 140
- “Set Permissions” on page 141

1 Define a Template

You define a new template using the New Template wizard. Enter the template name and description on the General Attributes page of the wizard. For details, see “Template General Attributes Page” on page 152.

Note: The template is created in the same folder as the view currently selected in the views tree.

2 Define the Base TQL

The TQL is assigned the same name as the template. For details, see “Template Base TQL Page” on page 152.

3 Set the Advanced Properties

On the Advanced Properties page of the wizard, enter the viewing options for the template. For details, see “Advanced Properties Page” on page 153.

4 Add Nodes and Relationships to a TQL Query

Add the nodes and relationships that define the query. For details on how to add nodes and relationships to a TQL query, see “Add Nodes and Relationships to a TQL Query” on page 330.

Note: You must add at least one node in order to save your template.

5 Add Folding Rules to Relationships

You can add folding rules to selected relationships by right-clicking the relationship you want and selecting **Add Rule**. For details, see **Add Rule** in “Context Menu Options” on page 339.

6 Set Permissions

Apply viewing and editing permissions to users and user groups for that template. You set permissions in **Admin > Settings > Users and Roles**. For details, see “Users and Roles User Interface” on page 641.

Create a Perspective

This task describes how to define a new perspective.

This task includes the following steps:

- “Define a Perspective” on page 141
- “Define the Base TQL” on page 141
- “Set the Advanced Properties” on page 142
- “Select a Contact Node” on page 142
- “Add Nodes and Relationships to a TQL Query” on page 142
- “Add Folding Rules to Relationships” on page 142
- “Set Permissions” on page 142

1 Define a Perspective

You define a new perspective using the New Perspective wizard. Enter the perspective name and description on the General Attributes page of the wizard. For details, see “Perspective General Attributes Page” on page 148.

Note: The perspective is created in the same folder as the view currently selected in the views tree.

2 Define the Base TQL

The TQL is assigned the same name as the perspective. For details, see “Perspective Base TQL Page” on page 149.

3 Set the Advanced Properties

On the Advanced Properties page of the wizard, enter the viewing options for the perspective. For details, see “Advanced Properties Page” on page 150.

4 Select a Contact Node

On the Contact Node page of the wizard, select a CI type from the tree to serve as a contact node of your perspective. For details, see “Contact Node Page” on page 149.

5 Add Nodes and Relationships to a TQL Query

Add the nodes and relationships that define the query. For details, see “Add Nodes and Relationships to a TQL Query” on page 330.

6 Add Folding Rules to Relationships

You can add folding rules to selected relationships by right-clicking the relationship you want and selecting **Add Rule**. For details, see **Add Rule** in “Context Menu Options” on page 339.

7 Set Permissions

Apply viewing and editing permissions to users and user groups for that template. You set permissions in **Admin > Settings > Users and Roles**. For details, see “Users and Roles User Interface” on page 641.

Create a Template Based View

This task describes how to define a new template based view.

This task includes the following steps:

- “Prerequisites” on page 143
- “Define a New Template Based View” on page 143
- “Select a Template” on page 143
- “Set the Advanced Properties” on page 143

- “Set Parameters” on page 143
- “Set Permissions” on page 144

1 Prerequisites

If you want to base your view on a new template, create the template first. For details, see “New Template/Template Properties/Save As Template Wizard” on page 151.

2 Define a New Template Based View

You define a new template based view using the New View wizard. Select **Template Based** as the view type on the General Attributes page of the wizard. For details, see “View General Attributes Page” on page 155.

Note: The view is created in the same folder as the view currently selected in the views tree.

3 Select a Template

On the Available Templates page of the wizard, select a template on which to base your view. For details, see “Available Templates Page” on page 155.

4 Set the Advanced Properties

On the Advanced Properties page of the wizard, enter the viewing options for the view. For details, see “Advanced Properties Page” on page 157.

5 Set Parameters

On the Set Parameters page, enter the parameter values for the view. A separate wizard page appears for each item in the template for which parameterized values were defined. For details, see “Set Parameters Page” on page 158.

6 Set Permissions

Apply viewing and editing permissions to users and user groups for that view. You set permissions in **Admin > Settings > Users and Roles**. For details, see “Users and Roles User Interface” on page 641.

Create a Pattern View

This task describes how to create a pattern view and define its TQL query.

This task includes the following steps:

- ▶ “Define a Pattern View” on page 144
- ▶ “Define the Base TQL” on page 144
- ▶ “Set the Advanced Properties” on page 145
- ▶ “Add Nodes and Relationships to a TQL Query” on page 145
- ▶ “Add Folding Rules to Relationships” on page 145
- ▶ “Define Multiple Relationship Rules” on page 145

1 Define a Pattern View

You define a new pattern view using the New View wizard. Select **Pattern** as the view type on the General Attributes page of the wizard. For details, see “View General Attributes Page” on page 155.

Note: The view is created in the same folder as the view currently selected in the views tree.

2 Define the Base TQL

If you are basing your view on a new TQL, the TQL is assigned the same name as the view. If you are basing your view on an existing TQL, select it from the drop-down list. For details, see “View Base TQL Page” on page 156.

3 Set the Advanced Properties

On the Advanced Properties page of the wizard, enter the viewing options for the view. For details, see “Advanced Properties Page” on page 157.

4 Add Nodes and Relationships to a TQL Query

Add the nodes and relationships that define the query. For details on how to add nodes and relationships to a TQL query, see “Add Nodes and Relationships to a TQL Query” on page 330.

Note: You must add at least one node in order to save your view.

5 Add Folding Rules to Relationships

You can add folding rules to selected relationships by right-clicking the relationship you want and selecting **Add Rule**. For details, see **Add Rule** in “Context Menu Options” on page 339.

6 Define Multiple Relationship Rules

You can define multiple relationship rules to define the structure between CITs in a view using the Relationship Folding Rules dialog box. For details, see “Relationship Folding Rules Dialog Box” on page 162.

View Manager User Interface

This section describes:

- ▶ Add/Edit Relationship Folding Rule Dialog Box on page 146
- ▶ List of Dependent Views Dialog Box on page 147
- ▶ New Perspective/Perspective Properties/Save As Perspective Wizard on page 148
- ▶ New Template/Template Properties/Save As Template Wizard on page 151
- ▶ New View/View Properties/Save As View Wizard on page 154

- ▶ Node/Relationship Grouping Dialog Box on page 159
- ▶ Relationship Folding Rules Dialog Box on page 162
- ▶ Set View Parameters/Set View Element Parameters Dialog Box on page 163
- ▶ View Manager Window on page 164

Add/Edit Relationship Folding Rule Dialog Box

| | |
|------------------------------|---|
| Description | Enables you to add a new relationship folding rule or edit an existing relationship folding rule. To access: In View Manager, click Add or Edit from the Relationship Folding Rules dialog box. |
| Important Information | You can define sibling and child rules for the same relationship between two CITs. However, you cannot define parent and child rules for the same relationship, or left sibling and right sibling rules. |
| Included in Tasks | “Create a Pattern View” on page 144 |
| Useful Links | “Relationship Folding Rules Dialog Box” on page 162 |

The following elements are included (unlabeled GUI elements are shown in angle brackets>):

| GUI Element (A-Z) | Description |
|--------------------------|---|
| Node 1 | Select the required Node1 node in the Node1 list. |
| Node 2 | Select the required Node2 node in the Node2 list. |
| Relationship | From the Relationship list, select an available relationship connecting the Node1 node to the Node2 node. (Enabled only after you define both CITs.) |
| Rule | From the Rule list, select a folding rule: Parent , Right Sibling , Left Sibling , or Child . For details, see “Adding Folding Rules to Relationships” on page 44. |



List of Dependent Views Dialog Box

| | |
|--------------------|--|
| Description | <p>Enables you to disconnect a view from a template or perspective that has changed, delete the view, or reapply the template or perspective.</p> <p>To access: In View Manager, when saving a template or perspective with a change, the List of Dependent Views dialog box automatically opens.</p> |
|--------------------|--|

The following elements are included (unlabeled GUI elements are shown in angle brackets>):

| GUI Element (A-Z) | Description |
|--------------------------------|--|
| Invalid Dependent Views | <p>For each dependent view listed, select one of the following options:</p> <ul style="list-style-type: none"> ▶ Disconnect. Disconnects the view from the template or perspective. The view becomes an independent pattern view. ▶ Delete. Deletes the view from the CMDB. |
| Valid Dependent Views | <p>For each dependent view listed, select one of the following options:</p> <ul style="list-style-type: none"> ▶ Reapply. Applies the changed template or perspective to the view and saves the view. ▶ Disconnect. Disconnects the view from the template or perspective. The view becomes an independent pattern view. |

New Perspective/Perspective Properties/Save As Perspective Wizard

| | |
|------------------------------|---|
| Description | <p>Enables you to define a new perspective or edit the properties of an existing perspective.</p> <p>To access: In View Manager, click the downward arrow next to the New button  and select New Perspective, or select New > New Perspective from the context menu in the Views pane.</p> <p>Click the Properties button  or select Properties from the context menu to edit the properties of an existing perspective.</p> <p>Select Save As from the context menu or select Resources > Save As to save an existing perspective with a different name.</p> |
| Important Information | <p>TQL queries should only be created by administrators with an advanced knowledge of the TQL system.</p> <p>For more information on perspectives, see “Building a Perspective Based View” on page 88.</p> |
| Included in Tasks | <p>“Create a Perspective” on page 141</p> |
| Wizard Map | <p>The New Perspective/Perspective Properties/Save As Perspective wizard contains:</p> <p>Perspective General Attributes Page > Contact Node Page > Perspective Base TQL Page > Advanced Properties Page</p> |

Perspective General Attributes Page

| | |
|------------------------------|--|
| Description | <p>Enables you to define the general attributes of the new perspective.</p> |
| Important Information | <p>For more information on perspectives, see “Building a Perspective Based View” on page 88.</p> |
| Wizard Map | <p>The New Perspective/Perspective Properties/Save As Perspective Wizard contains:</p> <p>Perspective General Attributes Page > Contact Node Page > Perspective Base TQL Page > Advanced Properties Page</p> |

The following elements are included (unlabeled GUI elements are shown in angle brackets):

| GUI Element (A-Z) | Description |
|-------------------------|---|
| Perspective Description | Enter a description of the new perspective. |
| Perspective Name | Enter a name for the new perspective. |

Contact Node Page

| | |
|-----------------------|--|
| Description | Enables you to select a contact node for a perspective. |
| Important Information | A perspective based view must have at least one contact node. For more information on perspectives, see “Building a Perspective Based View” on page 88. |
| Wizard Map | The New Perspective/Perspective Properties/Save As Perspective Wizard contains: Perspective General Attributes Page > Contact Node Page > Perspective Base TQL Page > Advanced Properties Page |

The following elements are included (unlabeled GUI elements are shown in angle brackets):

| GUI Element (A-Z) | Description |
|-------------------|---|
| <CI Type tree> | Select a CI type from the tree to serve as the contact node of the perspective. |

Perspective Base TQL Page

| | |
|-------------|---|
| Description | Enables you to define the base TQL for the new perspective. |
|-------------|---|

| | |
|------------------------------|--|
| Important Information | For more information on perspectives, see “Building a Perspective Based View” on page 88. |
| Wizard Map | The New Perspective/Perspective Properties/Save As Perspective Wizard contains: Perspective General Attributes Page > Contact Node Page > Perspective Base TQL Page > Advanced Properties Page |

The following elements are included (unlabeled GUI elements are shown in angle brackets>):

| GUI Element (A-Z) | Description |
|-----------------------------|--|
| Base TQL Description | A description of the query. |
| Base TQL Name | The query is defined by default with the same name as the perspective. |
| Base TQL Priority | From the TQL Priority list, select a priority level for the new query (Low, Medium, High, Express). This setting determines how often the query should be rerun automatically by the system to include updated information from the CMDB. |



Advanced Properties Page

| | |
|------------------------------|--|
| Description | Enables you to enter advanced properties for the perspective. |
| Important Information | For more information on perspectives, see “Building a Perspective Based View” on page 88. |
| Wizard Map | The New Perspective/Perspective Properties/Save As Perspective Wizard contains: Perspective General Attributes Page > Contact Node Page > Perspective Base TQL Page > Advanced Properties Page |

The following elements are included (unlabeled GUI elements are shown in angle brackets>):

| GUI Element (A-Z) | Description |
|----------------------------------|--|
| Merge Identical Instances | When the check box is selected, identical instances that appear on the same layer in this perspective are automatically merged into one symbol in the editing pane. This helps you remove redundant information and sharpen the perspective's focus. For details, see "Merge Identical Instances" on page 138. |
| Persistent View | Defines whether you want the selected perspective to always remain in the system memory. You should use this option only for perspectives that are used frequently. |
| Track Changes | Select to be notified when CIs are added or removed. The changes are tracked in the system by creating daily snapshots of the perspective. |

New Template/Template Properties/Save As Template Wizard

| | |
|------------------------------|---|
| Description | <p>Enables you to define a new template or edit the properties of an existing template.</p> <p>To access: In View Manager, click the downward arrow next to the New button  and select New Template, or select New > New Template from the context menu in the Views pane.</p> <p>Click the Properties button  or select Properties from the context menu to edit the properties of an existing template.</p> <p>Select Save As from the context menu or select Resources > Save As to save an existing template with a different name.</p> |
| Important Information | TQL queries should only be created by administrators with an advanced knowledge of the TQL system. |

| | |
|--------------------------|--|
| Included in Tasks | “Create a Parameterized Template” on page 139 |
| Wizard Map | The New Template/Template Properties/Save As Template wizard contains: Template General Attributes Page > Template Base TQL Page > Advanced Properties Page |

Template General Attributes Page

| | |
|--------------------|---|
| Description | Enables you to define the general attributes of the new template. |
| Wizard Map | The New Template/Template Properties/Save As Template Wizard contains: Template General Attributes Page > Template Base TQL Page > Advanced Properties Page |

The following elements are included (unlabeled GUI elements are shown in angle brackets>):

| GUI Element (A-Z) | Description |
|-----------------------------|--|
| Template Description | Enter a description of the new template. |
| Template Name | Enter a name for the new template. |

Template Base TQL Page

| | |
|--------------------|---|
| Description | Enables you to define the base TQL for the new template. |
| Wizard Map | The New Template/Template Properties/Save As Template Wizard contains: Template General Attributes Page > Template Base TQL Page > Advanced Properties Page |

The following elements are included (unlabeled GUI elements are shown in angle brackets>):

| GUI Element (A-Z) | Description |
|-----------------------------|--|
| Base TQL Description | A description of the query. |
| Base TQL Name | The query is defined by default with the same name as the template. |
| Base TQL Priority | From the TQL Priority list, select a priority level for the new query (Low, Medium, High, Express). This setting determines how often the query should be rerun automatically by the system to include updated information from the CMDB. |



Advanced Properties Page

| | |
|--------------------|---|
| Description | Enables you to enter advanced properties for the template. |
| Wizard Map | The New Template/Template Properties/Save As Template Wizard contains: Template General Attributes Page > Template Base TQL Page > Advanced Properties Page |

The following elements are included (unlabeled GUI elements are shown in angle brackets>):

| GUI Element (A-Z) | Description |
|----------------------------------|--|
| Merge Identical Instances | When the check box is selected, identical instances that appear on the same layer in this template are automatically merged into one symbol in the editing pane. This helps you remove redundant information and sharpen the template's focus. For details, see "Merge Identical Instances" on page 138. |
| Persistent View | Defines whether you want the selected template to always remain in the system memory. You should use this option only for templates that are used frequently. |
| Track Changes | Select to be notified when CIs are added or removed. The changes are tracked in the system by creating daily snapshots of the template. |

New View/View Properties/Save As View Wizard

| | |
|------------------------------|---|
| Description | <p>Enables you to define a new view or edit the properties of an existing view.</p> <p>To access: In View Manager, click the New button  or select New > New View from the context menu in the Views pane to create a new view.</p> <p>Click the Properties button  or select Properties from the context menu to edit the properties of an existing view.</p> <p>Select Save As from the context menu or select Resources > Save As to save an existing view with a different name.</p> |
| Important Information | TQL queries should only be created by administrators with an advanced knowledge of the TQL system. |

| | |
|--------------------------|---|
| Included in Tasks | “Create a Template Based View” on page 142, “Create a Pattern View” on page 144 |
| Wizard Map | The New View/View Properties/Save As View wizard contains: View General Attributes Page > (Available Templates Page) > (View Base TQL Page) > Advanced Properties Page > (Set Parameters Page) |

View General Attributes Page

| | |
|--------------------|--|
| Description | Enables you to define the general attributes of the new view. |
| Wizard Map | The New View/View Properties/Save As View Wizard contains: View General Attributes Page > (Available Templates Page) > (View Base TQL Page) > Advanced Properties Page > (Set Parameters Page) |

The following elements are included (unlabeled GUI elements are shown in angle brackets>):

| GUI Element (A-Z) | Description |
|--------------------------|--|
| View Description | Enter a description of the new view. |
| View Name | Enter a name for the new view. |
| View Type | Select Pattern to create a pattern view. Select Template Based to create a template based view. |

Available Templates Page

| | |
|--------------------|---|
| Description | Enables you to select a template for a template based view. |
|--------------------|---|

| | |
|------------------------------|--|
| Important Information | This wizard page only appears if Template Based was selected as the view type in the previous step. |
| Wizard Map | The New View/View Properties/Save As View Wizard contains: View General Attributes Page > (Available Templates Page) > (View Base TQL Page) > Advanced Properties Page > (Set Parameters Page) |

The following elements are included (unlabeled GUI elements are shown in angle brackets>):

| GUI Element (A-Z) | Description |
|-----------------------------|---|
| Base TQL Name | Displays the name of the TQL on which the selected template is based. |
| Template Description | A description of the selected template. |
| Template Name | Select a template from the drop-down list. |

View Base TQL Page

| | |
|------------------------------|--|
| Description | Enables you to define the base TQL for the new view. |
| Important Information | This wizard page only appears if Pattern was selected as the view type in the previous step. |
| Wizard Map | The New View/View Properties/Save As View Wizard contains: View General Attributes Page > (Available Templates Page) > (View Base TQL Page) > Advanced Properties Page |

The following elements are included (unlabeled GUI elements are shown in angle brackets>):

| GUI Element (A-Z) | Description |
|---|---|
| Base the view on a new TQL | Select to base your view on a new TQL. |
| Base the view on an existing TQL | Select to base your view on an existing TQL. |
| Base TQL Description | A description of the query. |
| Base TQL Name | <p>If you are basing your view on an existing TQL, select the TQL query from the drop-down list. Only queries of type view appear in the list. If the query you want does not appear in the list, go to Query Manager and save it as a type view query. For details, see “Query Manager User Interface” on page 285.</p> <p>If you are basing your view on a new TQL, the query is defined by default with the same name as the view.</p> |
| Base TQL Priority | From the TQL Priority list, select a priority level for the new query (Low, Medium, High, Express). This setting determines how often the query should be rerun automatically by the system to include updated information from the CMDB. |
| Save a new TQL based on the current definition | <p>Select to save a new TQL based on your view definition.</p> <p>Note: This field only appears in the Save As View wizard.</p> |

Advanced Properties Page

| | |
|--------------------|---|
| Description | Enables you to enter advanced properties for the view. |
| Wizard Map | <p>The New View/View Properties/Save As View Wizard contains:</p> <p>View General Attributes Page > (Available Templates Page) > (View Base TQL Page) > Advanced Properties Page > (Set Parameters Page)</p> |

The following elements are included (unlabeled GUI elements are shown in angle brackets>):

| GUI Element (A-Z) | Description |
|----------------------------------|--|
| Ad Hoc View | When the check box is selected, the view is defined as an Ad-hoc view. An Ad-hoc view is not updated automatically as changes occur in the system. The view is updated only when you schedule an update using the Scheduler. For details, see “Scheduler User Interface” on page 488. |
| Merge Identical Instances | When the check box is selected, identical instances that appear on the same layer in this view are automatically merged into one symbol in the editing pane. This helps you remove redundant information and sharpen the view’s focus. For details, see “Merge Identical Instances” on page 138. |
| Persistent View | Defines whether you want the selected view to always remain in the system memory. You should use this option only for views that are used frequently. |
| Track Changes | Select to be notified when CIs are added or removed. The changes are tracked in the system by creating daily snapshots of the view. |

 **Set Parameters Page**

| | |
|--------------------|---|
| Description | Enables you to enter parameterized attribute values for the view. |
|--------------------|---|

| | |
|------------------------------|--|
| Important Information | This wizard page only appears if Template Based was selected as the view type. A separate page appears for each CI or relationship that has parameterized attribute values in the selected template. |
| Wizard Map | The New View/View Properties/Save As View Wizard contains: View General Attributes Page > (Available Templates Page) > (View Base TQL Page) > Advanced Properties Page > (Set Parameters Page) |





The following elements are included (unlabeled GUI elements are shown in angle brackets>):

| GUI Element (A-Z) | Description |
|-------------------|---|
| Attribute | The name of each attribute with a parameterized value. |
| Operator | The operator defined for each attribute. |
| Value | Click the field to open an editing dialog box, which enables you to set the parameterized value of the attribute. |

Node/Relationship Grouping Dialog Box

| | |
|------------------------------|---|
| Description | Enables you to define a new grouping of CIs or to edit an existing grouping. To access: In View Manager, select Node Grouping or Relationship Grouping from the context menu in the editing pane. |
| Important Information | You select and enter the information for the CI groupings in the fields at the bottom of the dialog box. The groupings you define are displayed in the table at the center of the dialog box. |

The following elements are included (unlabeled GUI elements are shown in angle brackets>):

| GUI Element (A-Z) | Description |
|---|--|
|  | Click to add a grouping to the table based on the information entered. |
|  | Deletes the selected CI group. |
|  | Moves selected row up. |
|  | Moves selected row down. |
| Attribute name | <p>If you are grouping by attribute, select the appropriate Attribute name.</p> <p>You can right-click this field to select Advanced Properties, which opens the Advanced Attribute Properties dialog box.</p> |
| Group By | <p>Select the criteria by which to group the CIs. The following options are available:</p> <ul style="list-style-type: none"> ▶ Configuration Item Type. Groups CIs in the Topology Map by their CI type. ▶ TQL Node. Groups all CIs of the same CI type that fulfill the node grouping criteria. By default, these CIs appear in the Topology Map under a folder containing the name of the selected TQL node and an automatically added identification number. ▶ Attribute. Groups CIs of multiple CI types in the Topology Map, according to the attribute selected from the list. A CI can be a member of multiple groups. |
| Group label | <p>Enter the label of the group.</p> <p>Note: This field is optional.</p> |
| Minimum in group | <p>Enter the minimum number of matching CIs required to create the group. By default there must be at least one CI in the group.</p> <p>Note: This field is optional.</p> |





Advanced Attribute Properties

| GUI Element (A-Z) | Description |
|-------------------------|---|
| Attribute Name | The name of the selected attribute. |
| Group List | Define the specific groups of the selected attribute to be created. For example, to display two groups of IP addresses that end between 0 and 100, enter 0-50, 51-100. Any IPs that fall outside this group are placed automatically into the Others group. |
| Mask to group by | <p>Enter a regular expression, as follows:</p> <ul style="list-style-type: none"> ▶ In the first field, enter the regular expression pattern. This is the structure of the selected attribute. ▶ In the second field, enter the group number. This is the part of the regular expression pattern on which to focus when creating the group. <p>For details, see “Grouping By Attribute Properties” on page 137.</p> |

Relationship Folding Rules Dialog Box

| | |
|------------------------------|---|
| Description | Enables you to define multiple relationship rules. To access: In View Manager, select Relationship Folding Rules from the context menu in the Views pane. |
| Important Information | As an alternative to adding folding rules, you can choose to define multiple relationship rules. You define relationship rules to define the structure between CITs in a view. This is in contrast to folding rules where you define the structure of two nodes connected to a specific relationship. For example, if one of the view's nodes is a host, you can specify different relationships for Windows, UNIX, router, and so on. By assigning different folding rules to different CITs, views can encompass and represent additional query data. Note: If both folding and relationship rules are defined, the definitions for the folding rules override the definitions for relationship rules. |
| Included in Tasks | "Create a Pattern View" on page 144 |
| Useful Links | "Add/Edit Relationship Folding Rule Dialog Box" on page 146 |

The following elements are included (unlabeled GUI elements are shown in angle brackets>):

| GUI Element (A-Z) | Description |
|---|---|
|  | Opens the Add Rule dialog box where you can add a rule. For details, see "Add/Edit Relationship Folding Rule Dialog Box" on page 146. |
|  | Opens the Edit Rule dialog box where you can edit the selected rule. "Add/Edit Relationship Folding Rule Dialog Box" on page 146. |
|  | Deletes the selected rule. |
|  | Moves selected row up. |

| GUI Element (A-Z) | Description |
|---|--------------------------------------|
|  | Moves selected row down. |
| Relationship | The type of relationship. |
| Rule | The relevant folding rule. |
| Source | The source node of the relationship. |
| Target | The target node of the relationship. |

Set View Parameters/Set View Element Parameters Dialog Box

| | |
|------------------------------|---|
| Description | <p>Enables you to edit the predefined parameters of conditions of nodes in a view.</p> <p>To access: In View Manager, right-click a view in the Views pane and select Set View Parameters from the context menu or right-click a node in the editing pane and select Set View Element Parameters from the context menu.</p> <p>Note: This menu option is only available if a parameterized value has been set for an attribute of a node in the view.</p> |
| Important Information | <p>When you select Set View Element Parameters from the right-click menu for a node in the editing pane, the dialog box displays only the conditions for the selected node. When you select Set View Parameters from the right-click menu in the Views pane, the dialog box displays any conditions that are defined for all nodes in the view.</p> |
| Included in Tasks | “Create a Template Based View” on page 142 |

The following elements are included (unlabeled GUI elements are shown in angle brackets>):

| GUI Element (A-Z) | Description |
|-------------------|--|
| Display Name | The name of each attribute with a parameterized value. |
| Operator | The operator defined for each attribute. |
| Value | Click the field to open an editing dialog box, which enables you to change the parameterized value of the attribute. |













View Manager Window





| | |
|--------------------|--|
| Description | <p>Enables you to create, edit, and save a view.</p> <p>The View Manager window contains the following panes:</p> <ul style="list-style-type: none"> ▶ Views pane. Displays a hierarchical tree structure of the views that you defined. ▶ Editing pane. Displays the currently selected view, which consists of nodes and the relationships between them. ▶ CI Type Selector. Displays a hierarchical tree structure of the available CI types. ▶ Information Pane. Displays properties, conditions, and cardinality for the selected node or relationship. <p>To access: Select Admin > Modeling > View Manager.</p> |
|--------------------|--|

Views Pane

| | |
|------------------------------|--|
| Description | Enables you to select a view to edit. |
| Important Information | The Views Pane contains a hierarchical file folder system to help you organize your views, displayed in the Views pane. Predefined folders are provided for the out-of-the-box views; you can modify these folders, or add additional folders according to your organization's requirements. |

The following elements are included (unlabeled GUI elements are shown in angle brackets>):

| GUI Element (A-Z) | Description |
|---|---|
|  | Create a new folder. |
|  | Click to define a new view. For details, see “New View/View Properties/Save As View Wizard” on page 154. Click the downward arrow to select the New Template wizard or the New Perspective wizard. |
|  | Click Filter Tree to filter the types of views and templates that appear in the tree. |
|  | Delete the selected folder or view. |
|  | Click to refresh the data content of the hierarchical tree structure that may have been modified by other users. |
|  | Save the view to the CMDB. |
|  | Opens the View Properties, Template Properties, or Perspective Properties wizard for the selected view, template, or perspective. |
|  | Generate a preview of the existing views in the CMDB that match the pattern of the current view. |
|  | Click Show View Results in IT Universe to go directly to IT Universe Manager for the current view. Note: This feature is not relevant for templates or perspectives. |
|  | Click Expand All to expand all folders in the tree. |
|  | Click Collapse All to collapse all folders in the tree. |
|  | Denotes a view folder. Double-click the icon to expand the folder. |
|  | Denotes a pattern view. |

| GUI Element (A-Z) | Description |
|---|---|
|  | Denotes a perspective based view. When you select a perspective based view in the view tree, a dialog box opens with the following options: <ul style="list-style-type: none"> ➤ Open in Modeling Studio. Opens the view in the Modeling Studio, where it can be edited. ➤ Delete. Deletes the view from the CMDDB. ➤ Disconnect view from perspective. Disconnects the view from the perspective, turning it into a regular pattern view, which can be edited in View Manager. |
|  | Denotes a template based view. |
|  | Denotes a template. |
|  | Denotes a perspective. |
| Root | Denotes the top level folder, containing all other view folders. |

Context Menu Options

The View Manager Window includes the following elements (listed alphabetically) available by right-clicking a folder or view in the Views pane:

| Menu Item | Description |
|---------------------------------|---|
| Activate/Deactivate View | If the view is active, you can select Deactivate View to make it inactive. If the view is inactive, you can select Activate View to activate it. When you deactivate a view, a red X appears on it. Inactive views are not recalculated and cannot be selected in IT Universe Manager. Note: This option is only available for pattern views. |
| Delete | Deletes a selected folder or view. |

| Menu Item | Description |
|--------------------------------------|--|
| Disconnect View from Template | <p>Select Disconnect View from Template to detach a template based view from its template. It becomes a pattern view and is no longer affected by changes made to the template.</p> <p>Note: This option only appears for template based views.</p> |
| Export | Displays a standard Save As dialog box, enabling you to save the view as an XML script. |
| Import | Opens the Import dialog box which enables you to import XML files containing views. |
| New Folder | Creates a new view folder. |
| New View | <p>The following options are available:</p> <ul style="list-style-type: none"> ▶ New View wizard, which enables you to define a new view. For details, see “New View/View Properties/Save As View Wizard” on page 154. ▶ New Template wizard, which enables you to define a new template. For details, see “New Template/Template Properties/Save As Template Wizard” on page 151. ▶ New Perspective wizard, which enables you to define a new perspective. For details, see “New Perspective/Perspective Properties/Save As Perspective Wizard” on page 148. |
| Preview | Generates a preview of the existing views in the CMDB that match the pattern of the current view. |
| Properties | Opens the View Properties, Template Properties, or Perspective Properties wizard for the selected view, template, or perspective. |
| Relationship Folding Rules | Displays the Relationship Folding Rules dialog box which enables you to define multiple relationship rules. For details, see “Relationship Folding Rules Dialog Box” on page 162. |
| Rename Folder | Enables you to rename the view folder. |

| Menu Item | Description |
|---|---|
| Save As | <p>Opens the Save As View wizard which enables you to save the view to the CMDB after you have modified it. For details, see “New View/View Properties/Save As View Wizard” on page 154.</p> <p>Note: If you exit View Manager without saving, a confirmation dialog box is displayed, requesting that you save your view.</p> |
| Set View Parameters | <p>Appears if at least one node in the view has a parameterized node condition. Displays the Set View Parameters dialog box where you can edit the parameter of each condition. For details, see “Set View Parameters/Set View Element Parameters Dialog Box” on page 163.</p> |
| Show View Results in IT Universe | <p>Takes you to IT Universe Manager and opens the selected view.</p> <p>Note: This option does not appear for templates or perspectives.</p> |

Editing Pane

| | |
|------------------------------|--|
| Description | <p>Displays the selected view, which consists of nodes and the relationships between them.</p> <ul style="list-style-type: none"> ▶ When you select a folder in the Views pane, the editing pane is empty. ▶ When you select a view in the Views pane, the editing pane displays the selected view. The name of the view appears at the top of the pane. |
| Important Information | <p>After defining a view in the editing pane, you save it by clicking the Save button in the Views pane or by selecting Save from the context menu in the Views pane.</p> |
| Useful Links | <p>For information on defining a TQL query, see “Add Nodes and Relationships to a TQL Query” on page 330.</p> |





The following elements are included (unlabeled GUI elements are shown in angle brackets):

| GUI Element (A-Z) | Description |
|------------------------|---|
| <Context menu options> | For details, see “Context Menu Options” on page 339. |
| <Main menu> | For details, see “Main Menu” on page 713. |
| <Node> | A component from which TQL queries are built. |
| <Relationship> | The entity that defines the relationship between two nodes. |
| <Toolbar> | For details, see “Toolbar Options” on page 717. |
| <Tooltip> | <p>Hold the cursor over a node or relationship to view its tooltip.</p> <p>The tooltips contain the following information:</p> <ul style="list-style-type: none"> ▶ Element name. The name of the node. ▶ CI Type. The CIT of the CI as defined in the CI Type Manager. For details, see “CI Type Manager User Interface” on page 216. ▶ Visible. Indicates whether the selected node is visible in the Topology map. ▶ Cardinality. Relevant for nodes with relationships. Defines how many nodes you expect to have at the other end of the relationship. For example, in a relationship between host and IP, if the cardinality is 1:3, the TQL retrieves only the hosts that are connected 1 to 3 IPs. ▶ Folding Rule. Relevant for relationships. Indicates the folding rule defined for the relationship. ▶ Condition. Appears only if a condition has been defined for the node or relationship. |

CI Type Selector

| | |
|------------------------------|--|
| Description | <p>Displays a hierarchical tree structure of the CI Types found in the CMDB. For more details, see “CI Type Manager User Interface” on page 216.</p> <p>Note: The number of instances of each CIT in the CMDB is displayed to the right of each CIT.</p> <p>To create or modify a TQL query, click and drag nodes to the Editing pane and define the relationship between them. Your changes are saved to the CMDB. For details, see “Add Nodes and Relationships to a TQL Query” in <i>Model Management</i>.</p> |
| Important Information | <p>The CI Type Selector is part of the following managers: View Manager, Enrichment Manager, Query Manager, Correlation Manager, Topology Report Manager, and Trigger TQL Editor.</p> |
| Included in Tasks | <ul style="list-style-type: none"> ➤ “Define a Correlation Rule – Workflow” on page 179 ➤ “Define an Enrichment Rule – Scenario” on page 300 ➤ “Define a TQL Query” on page 328 ➤ “Create a Pattern View” on page 144 ➤ “Define a Report Rule – Scenario” on page 246 |

The following elements are included (unlabeled GUI elements are shown in angle brackets>):

| GUI Element (A-Z) | Description |
|---|---|
|  | Click Add CI Type to Map to move the selected CI type to the Editing pane. |
|  | Click Refresh to refresh the CI type tree. |
|  | Click Search to search for the CI type entered. |
|  | Click Expand All to expand all subtrees within the CI type tree. |

| GUI Element (A-Z) | Description |
|---|---|
|  | Click Collapse All to collapse the subtrees within the CI type tree. |
| <Search window> | Enter the name or part of a name of a CI type for which to search. |

Context Menu Options



The CI Type Selector includes the following elements (listed alphabetically) available by right-clicking a CI Type:

| Menu Item | Description |
|---------------------------------|---|
| Add CI Type to Map | Select to add the selected CI type to the Editing pane. |
| Go to CI Type Definition | Takes you directly to the selected CI type in CIT Manager. |
| Show CIT Instances | Opens the Show All Instances window, which displays all instances of the selected CIT. For details, see “Element Instances Dialog Box” in <i>Model Management</i> . |

Information Pane

| | |
|------------------------------|---|
| Description | Displays the properties, conditions, and cardinality for the selected node and relationship. |
| Important Information | <p>The Information pane appears in the lower part of the window in the following managers and user interfaces: View Manager, Correlation Manager, Query Manager, Topology Report Manager, Enrichment Manager, Discovery Input TQL Editor, and Discovery Trigger TQL Editor.</p> <p>A small green indicator * appears next to the tabs in which a change occurred.</p> |
| Included in Tasks | <ul style="list-style-type: none"> ▶ “Define a Correlation Rule – Workflow” on page 179 ▶ “Define an Enrichment Rule – Scenario” on page 300 ▶ “Define a TQL Query” on page 328 ▶ “Create a Pattern View” on page 144 ▶ “Define a Report Rule – Scenario” on page 246 |

The following elements are included (unlabeled GUI elements are shown in angle brackets>):

| GUI Element (A-Z) | Description |
|---|--|
|  | If the window is not wide enough to display all the tabs, use the left and right arrows to move to the required tab. |
|  | Click Show List to display a list of the available tabs for the current manager. You can select a tab from the list. |
| Affected Nodes | Displays which node is affected by the changes that occur in the selected trigger node. If required, you can click Edit to open and modify the Affected Nodes dialog box. For details, see “Affected Nodes Dialog Box” on page 186. Note: This tab appears only in Correlation Manager. |
| Attributes | Displays the attribute conditions defined for the node or the relationship. For details, see “Attribute Tab” on page 377. |
| Cardinality | Cardinality defines how many nodes you expect to have at the other end of a relationship. For example, in a relationship between host and IP, if the cardinality is 1:3, the TQL retrieves only those hosts that are connected to between one and three IPs. For details, see “Cardinality Tab” on page 379. |
| Details | Displays the following information: <ul style="list-style-type: none"> ▶ CI Type. The CIT of the selected node/relationship. ▶ Visible. A green check indicates that the selected node/relationship is visible in the topology map. A red mark indicates that it is not visible. ▶ Include subtypes. A green check indicates that both the selected CI and its children are displayed in the topology map. A red mark indicates that only the selected CI appears. |
| Edit | Click Edit to open the relevant dialog box for the selected tab. |

| GUI Element (A-Z) | Description |
|----------------------------|---|
| Enrichment Rules | <p>Displays the Enrichment rule defined for the selected node or relationship. If the Enrichment rule is used to update the attributes of a CI, click Edit to open the Node/Relationship Definition dialog box and edit the rule if required. For details, see “Node/Relationship Definition Dialog Box” on page 318.</p> <p>Note: This tab appears only in Enrichment Manager.</p> |
| Folding Rule | <p>Displays the folding rule defined for the selected relationship. For details about folding rules, see “Adding Folding Rules to Relationships” on page 44.</p> <p>Note: This tab appears only when a relationship is selected in View Manager.</p> |
| Grouping | <p>Displays the different CI groupings for the selected node, as defined in the Grouping dialog box.</p> <p>Note: This tab appears only in View Manager.</p> |
| Node Definition | <p>Displays the attributes to be included in the report for the selected node. If required, you can click Edit to open and modify the Report Node definition dialog box. For details, see “Report Node Definition Dialog Box” on page 276.</p> <p>Note: This tab appears only in Topology Report Manager.</p> |
| Qualifiers | <p>Displays the qualifier conditions defined for the node or the relationship. For details, see “Qualifier Tab” on page 382.</p> |
| Rule | <p>Displays the report folding rule defined for the selected relationship. For details about folding rules, see “Editing Pane” on page 270.</p> <p>Note: This tab appears only when a relationship is selected in Topology Report Manager.</p> |
| Selected Identities | <p>Displays the element instances that are used to define what should be included in the TQL results. For details, see “Identity Tab” on page 384.</p> |

Troubleshooting and Limitations

If a known folder does not appear in the Views pane in View Manager, or if a folder appears which should not be there, execute the following JMX command to refresh the folders:

```
MAM / Service=MAM New Folders Services / refresh()
```

5

Correlation Manager

This chapter provides information on Correlation Manager.

This chapter includes:

Concepts

- ▶ Correlation Manager Overview on page 177

Tasks

- ▶ Define a Correlation Rule – Workflow on page 179

Reference

- ▶ Correlation Manager User Interface on page 185

Correlation Manager Overview

Correlation Manager enables you to define the interdependencies between components in your IT infrastructure to simulate how infrastructure changes (for example, a new software installation or upgrade) can impact your system.

By creating Correlation rules based on TQL queries, you can determine the true origin of a problem and its business impact. Each Correlation rule you define is attached to a specific Correlation TQL query. For more information about TQL queries, see “Topology Query Language” on page 323.

You define Correlation rules to specify a causal relationship between two or more Correlation nodes. Define one node as the trigger, or the node that represents the changes you want to make to the system, and another node as the one that is affected. After the causal relationship is established, Correlation Manager enables you to determine the effect of the changes occurring in root cause nodes.

You then run the Correlation rules in the Topology View tab (go to **Applications > Topology View**) to simulate how the changes impact your system and discover the root causes of the changes (for details, see “Run Correlation Dialog Box” on page 528). This enables you to evaluate and handle accordingly, the possible implications of any action, update, new deployment, or a failure of the service delivery.

A simulated change in an affected CI can alter the CI’s map status, which is manifested through an addition of a status icon to the CI’s symbol. The Topology Map displays the statuses of the trigger CIs as well as all statuses of the CIs that are affected by it. Each color represents a different status.

For details about the status icons and the colors that represent them, see “Correlation Rules Window” on page 527.

You can then generate a report displaying the following:

- CIs in the system that are impacted by the changes.
- Trigger CIs (the CIs that represent the changes you want to make to the system).
- CIs that belong to a specific business service. For details, see “Link Nodes to Application CI” on page 134.

Define a Correlation Rule – Workflow

This section describes how to define a Correlation rule whereby a change in CPU usage affects the Host node to which it is connected.

Note: To retrieve the required Correlation results, you must follow each step in this task.

This task includes the following steps:

- “Create an Enumeration Definition” on page 180
- “Define a State — Optional” on page 182
- “Create a Correlation TQL Query” on page 183
- “Define a Correlation Rule” on page 183

1 Create an Enumeration Definition

Note: This step is optional. You can use the default Enumeration definitions that appear in the System Type Manager.

To retrieve Correlation results, you must create a Correlation rule in the Correlation Manager. A Correlation rule is based on a state that exists in the State Manager. For details, see “State Manager” on page 499.

A state is based on an Enumeration definition. Enumerations are designed to be used as severity value lists by states. You can either base a state on an existing Enumeration definition in the State Manager or, if required, create one by clicking the **New Enumeration** button. For details on creating Enumeration definitions, see “Create/Update List/Enumeration Definition Dialog Box” on page 240.

Note: Alternatively, you can create an Enumeration definition in the System Type Manager. For details, see “System Type Manager” on page 208. The Enumeration definition you create appears in the State Manager.

Example of an Enumeration Definition

Select **Admin > Settings > State Manager** to open the State Manager. In the bottom-right corner, click the **New Enumeration** button to open the Create Enumeration Definition dialog box.

The following Enumeration definition creates a severity list that represents CPU usage of 10%, 20%, and 50%.

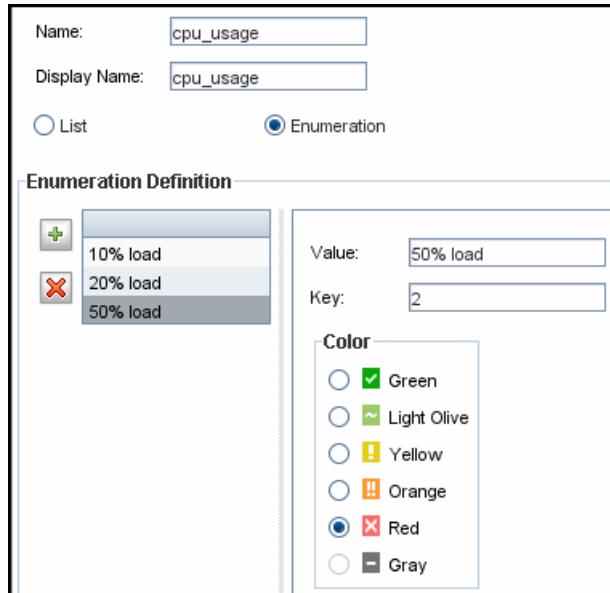

Name:

Display Name:

List Enumeration

Enumeration Definition

10% load

20% load

50% load

Value:

Key:

Color

Green

Light Olive

Yellow

Orange

Red

Gray

2 Define a State — Optional

Note: You can use the default states that appear in the State Manager or define another one if required.

When you create a Correlation Rule, you select the state on which the Correlation condition is based. The State Manager contains two default states — Change and Operation. Each one is based on its own severity list. You can use a default state, or if required, create one based on a severity list (Enumeration definition) that is more relevant to your needs.

To define a new state, select **Admin > Settings > State Manager** to open the State Manager. For details on defining a new state, see “State Manager Dialog Box” on page 501.

Example of a New State

A new state called **cpu_usage** is defined in the State Manager. Its Type Definition is based on the Enumeration definition called **cpu_usage** defined in the previous task.

| Name | Description | Type Definition |
|-----------|-----------------|---|
| change | Change State | Change States |
| operation | Operation State | Operation States |
| cpu_usage | CPU usage | <div style="border: 1px solid gray; padding: 2px;"> <ul style="list-style-type: none"> Admin States Test States Operation States concrete_synch_config_status synch_unit_state Status Accounting Identification Type cpu_usage </div> |

3 Create a Correlation TQL Query

To create a Correlation TQL query, you need to create a Correlation TQL and then add the TQL nodes and relationships that define the query.

Select **Admin > Modeling > Correlation Manager** to open the Correlation Manager. For details about how to create a Correlation TQL query, see “New Correlation Rule/Correlation Rule Properties/Save As Correlation Rule Wizard” on page 199. For details about how to add nodes and relationships to a query, see “Add Nodes and Relationships to a TQL Query” on page 330.

Example of a Correlation TQL Query

In this Correlation TQL query, a CPU and a Host node are linked by a Container Link relationship. The TQL results must comply with the direction of the arrows.

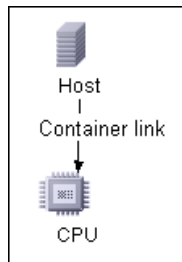

Note: A Correlation TQL query is subject to certain validation restrictions. For details, see “Troubleshooting and Limitations” on page 401.

4 Define a Correlation Rule

When you define a Correlation rule, you must specify the required causal relationship between the nodes. Define one node as the trigger, or the node that represents the changes you want to make to the system, and another node as the one that is affected.

Right-click the node you want to define as the trigger node and select **Define Affected** to open the Affected Nodes dialog box. In the Affected Nodes dialog box, select the node you want the trigger node to affect. Then click the **Add** button to open the Correlation Definition dialog box to set conditions for defining affected nodes. For details about how to define a Correlation rule, see “Correlation Definition Dialog Box” on page 187.

Example of a Correlation Rule

The Conditions area in the Correlation Definition dialog box defines the conditions under which the simulated change in the system is triggered. The Affected Severity area defines the severity of the Correlation impact on the affected node.

The Correlation rule in this example states that when the CPU usage of the Host node to which the CPU node is connected does not equal 10%, the Host node is automatically assigned the 50% load status, which in this case, is the color red according to the severity list.

The screenshot shows the Correlation Definition dialog box with the following configuration:

- Description:** CPU usage
- Conditions:**
 - State: cpu_usage
 - Operator: Not equal
 - Value comparison: 10% load
- Scope:**
 - Any
 - All
 - Range: 0 % - 100 %
- Affected Severity:**
 - Fixed severity: 50% load
 - Severity relative to trigger severity (%): 100

In the resulting TQL query, an upward arrow appears next to the node defined as the trigger node and a downward arrow appears next to the node defined as the affected node.

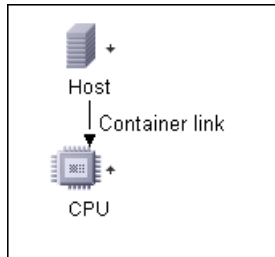

Note: To retrieve the Correlation results, you must run the Correlation rule in the Topology View tab. For details, see “Retrieve Correlation Results – Scenario” on page 516.

Correlation Manager User Interface

This section describes:

- Affected Nodes Dialog Box on page 186
- Correlation Definition Dialog Box on page 187
- Correlation Manager Window on page 189
- Details Dialog Box on page 198
- New Correlation Rule/Correlation Rule Properties/Save As Correlation Rule Wizard on page 199

Affected Nodes Dialog Box

| | |
|------------------------------|--|
| Description | Define which node in the TQL query is the trigger Correlation node and which nodes are affected by the changes that occurred in the system. To access: Right-click the node or relationship that functions as a trigger and select Define Affected . The Affected Nodes dialog box opens to display the nodes in the TQL. |
| Included in Tasks | “Define a Correlation Rule – Workflow” on page 179. |
| Important Information | Before creating the TQL, you must know which node in the TQL query is the trigger Correlation node and which are affected by the changes beforehand. The definition is performed here. |

The following elements are included (unlabeled GUI elements are shown in angle brackets>):

| GUI Element (A-Z) | Description |
|----------------------------|--|
| Affected Nodes pane | Contains a list of the Correlation nodes in the Correlation rule. Select the nodes to be affected by the trigger node. |

Correlation Definition Dialog Box

| | |
|---------------------------------|---|
| <p>Description</p> | <ul style="list-style-type: none"> ▶ In the Conditions area, set conditions for defining affected nodes. When this condition is met, the simulated change in the system is triggered. For example, you can define a Correlation condition that states that the operational state of the node is other than Normal. When the operational state of the node instance changes and is no longer Normal, the condition is met and the simulated changes in the system are triggered. ▶ In the Scope area, define how many instances of the trigger node should fulfill the conditions for triggering the changes in the system. You can apply the trigger conditions not only to one of the instances of a trigger node, but also to a certain percentage of the trigger instances, or to all of them. For example, you can define that impact is calculated when at least 10% of the system's hosts are down. ▶ In the Affected Severity area, define the severity of the Correlation impact. <p>To access: Click Add in the Details dialog box.</p> |
| <p>Included in Tasks</p> | <p>“Define a Correlation Rule – Workflow” on page 179</p> |

The following elements are included (unlabeled GUI elements are shown in angle brackets>):

| GUI Element (A-Z) | Description |
|------------------------------|---|
| <p>All</p> | <p>All instances should fulfill the conditions.</p> |
| <p>Any</p> | <p>One instance or more should fulfill the conditions.</p> |
| <p>Description</p> | <p>A description of the Correlation rule you are defining.</p> |
| <p>Fixed severity</p> | <p>Define a fixed severity level for every system change generated. Then, select the required severity level from the list.</p> |

| GUI Element (A-Z) | Description |
|--|--|
| Function | <p>Select Function (displayed when you selected the All and Range options in the Scope area) to define a severity level for the system changes, as a function of the severity levels of all the trigger node instances that are included in the range. From the list, select either Average or Max.</p> <p>For example, if you select Average, the severity level of the system changes is the average severity of all the trigger instances.</p> |
| Operator | <p>Select the required operator. For a list of the operators you can use for defining an attribute condition, see “Attribute Operator Definitions” on page 346.</p> |
| Range | <p>A certain percentage of all instances should fulfill the conditions. For example, if you enter a range of 50% to 100%, the changes are triggered when 50% or more of the instances meet the conditions.</p> |
| Severity relative to trigger severity (%) | <p>Select Severity relative to trigger severity (%) (displayed when you selected the Any option in the Scope area) to define a severity level for each system change that is relative (as a percentage) to the severity of the trigger event.</p> <p>Enter the percentage in the box provided.</p> |
| State | <p>Choose the required state. The states that appear in the list are the states that are defined in the State Manager. For details, see “State Manager” on page 499.</p> |
| Value Comparison | <p>Select the required attribute.</p> |





Correlation Manager Window





| | |
|------------------------------|---|
| Description | Define Correlation rules. To access: Select Admin > Modeling > Correlation Manager . |
| Important Information | When selecting nodes to function as Correlation triggers, they must comply with certain restrictions. For details, see “Troubleshooting and Limitations” on page 401. |
| Included in Tasks | “Define a Correlation Rule – Workflow” on page 179 |
| Useful Links | “Correlation Manager Overview” on page 177 |

Correlation Rules Pane

| | |
|--------------------|---|
| Description | <p>Displays a hierarchical tree structure of predefined folders and Correlation rules. Each Correlation rule is associated with a TQL query.</p> <p>You can create your own query, or work with the default queries provided with your HP Universal CMDB installation.</p> <p>The predefined folders are provided for the default queries; you can modify these folders, or add additional folders according to your organization’s requirements.</p> |
|--------------------|---|

The following elements are included (unlabeled GUI elements are shown in angle brackets>):

| GUI Element (A-Z) | Description |
|---|---|
|  | Create a new folder. |
|  | Creates a Correlation rule. Opens the New Correlation Rule Wizard. |
|  | Deletes the selected folder or Correlation rule. |
|  | Refreshes the data content of the hierarchical tree structure that may have been modified by other users. |

| GUI Element (A-Z) | Description |
|---|--|
|  | (Enabled only when a new Correlation rule is created or when changes are made to an existing one.) Saves the Correlation rule to the CMDB. |
|  | Opens the Correlation Rule Wizard. Enables you to change the description of the rule. |
|  | Generates a preview of the results of the selected Correlation rule. |
|  | Represents a folder. |
|  | Represents a Correlation rule. |

The following elements are available by right-clicking a folder or Correlation rule:



| GUI Element (A-Z) | Description |
|----------------------|---|
| Delete | Delete the selected folder or Correlation rule. |
| Export | Displays a standard Save As dialog box, enabling you to save the Correlation rule as an XML script. This option can be used to move a Correlation rule from one workstation to another, provided the related TQL query is also relocated. |
| Import | Imports XML files that contain saved Correlation rules to the Correlation Manager. |
| New | Creates a Correlation rule. Opens the New Correlation Rule Wizard. |
| New Folder | Creates a new folder. |
| Preview | Generates a preview of the results of the selected Correlation rule. |
| Properties | Opens the Correlation Rule Properties Wizard. Enables you to change the description of the rule. |
| Rename Folder | Rename the folder. |

| GUI Element (A-Z) | Description |
|-------------------|--|
| Save | (Enabled only when a new Correlation rule is created or when changes are made to an existing one.) Saves the Correlation rule to the CMDB. |
| Save As | Displays the Save As Correlation Rule wizard, enabling you to create new Correlation rules based on an existing query. |

Editing Pane

| | |
|------------------------------|---|
| Description | <p>Displays the selected Correlation rule, which consists of nodes that are defined in the TQL query and the relationships between them.</p> <ul style="list-style-type: none"> ▶ When you select a folder in the Correlation Rules pane, the editing pane is empty. ▶ When you select a Correlation rule in the Correlation Rules pane, the editing pane displays the selected rule, which consists of TQL nodes that are defined in the TQL query and the relationships between them. |
| Useful Links | “Add Nodes and Relationships to a TQL Query” on page 330 |
| Important Information | When selecting nodes to function as Correlation triggers, they must comply with certain restrictions. For details, see “Troubleshooting and Limitations” on page 401. |

The following elements are included (unlabeled GUI elements are shown in angle brackets>):





| GUI Element (A-Z) | Description |
|---|---|
|  | Indicates a trigger node. Located to the right of the trigger node's icon. |
|  | Indicates an affected node. Located to the right of the affected node's icon. |
|  | Indicates nodes that are both affected and trigger nodes. |

| GUI Element (A-Z) | Description |
|------------------------|---|
| <Context menu options> | For details, see “Context Menu Options” on page 339. |
| <Main Menu> | For details, see “Main Menu” on page 713. |
| <Node> | A component from which TQL queries are built. |
| <Relationship> | The entity that defines the relationship between two nodes. |
| <Toolbar> | For details, see “Toolbar Options” on page 717. |
| <Tooltip> | <p>Hold the cursor over a node or relationship to view its tooltip.</p> <p>The tooltips contain the following information:</p> <ul style="list-style-type: none"> ▶ Element name. The name of the node. ▶ CI Type. The CIT of the node as defined in the CI Type Manager. For details, see “CI Type Manager” on page 205. ▶ Definitions of the selected nodes and relationships. The attribute conditions, as described in “Node/Relationship Properties Dialog Box” on page 375. ▶ Names of the trigger and the affected nodes. This is only relevant if the node over which the cursor is hovering is the trigger node. |
| Define Affected | Displays the Affected Nodes dialog box. |

CI Type Selector

| | |
|------------------------------|--|
| Description | <p>Displays a hierarchical tree structure of the CI Types found in the CMDB. For more details, see “CI Type Manager User Interface” on page 216.</p> <p>Note: The number of instances of each CIT in the CMDB is displayed to the right of each CIT.</p> <p>To create or modify a TQL query, click and drag nodes to the Editing pane and define the relationship between them. Your changes are saved to the CMDB. For details, see “Add Nodes and Relationships to a TQL Query” in <i>Model Management</i>.</p> |
| Important Information | <p>The CI Type Selector is part of the following managers: View Manager, Enrichment Manager, Query Manager, Correlation Manager, Topology Report Manager, and Trigger TQL Editor.</p> |
| Included in Tasks | <ul style="list-style-type: none"> ▶ “Define a Correlation Rule – Workflow” on page 179 ▶ “Define an Enrichment Rule – Scenario” on page 300 ▶ “Define a TQL Query” on page 328 ▶ “Create a Pattern View” on page 144 ▶ “Define a Report Rule – Scenario” on page 246 |

The following elements are included (unlabeled GUI elements are shown in angle brackets>):

| GUI Element (A-Z) | Description |
|---|---|
|  | Click Add CI Type to Map to move the selected CI type to the Editing pane. |
|  | Click Refresh to refresh the CI type tree. |
|  | Click Search to search for the CI type entered. |
|  | Click Expand All to expand all subtrees within the CI type tree. |

| GUI Element (A-Z) | Description |
|---|---|
|  | Click Collapse All to collapse the subtrees within the CI type tree. |
| <Search window> | Enter the name or part of a name of a CI type for which to search. |

Context Menu Options



The CI Type Selector includes the following elements (listed alphabetically) available by right-clicking a CI Type:

| Menu Item | Description |
|---------------------------------|---|
| Add CI Type to Map | Select to add the selected CI type to the Editing pane. |
| Go to CI Type Definition | Takes you directly to the selected CI type in CIT Manager. |
| Show CIT Instances | Opens the Show All Instances window, which displays all instances of the selected CIT. For details, see “Element Instances Dialog Box” in <i>Model Management</i> . |

Information Pane

| | |
|------------------------------|---|
| Description | Displays the properties, conditions, and cardinality for the selected node and relationship. |
| Important Information | <p>The Information pane appears in the lower part of the window in the following managers and user interfaces: View Manager, Correlation Manager, Query Manager, Topology Report Manager, Enrichment Manager, Discovery Input TQL Editor, and Discovery Trigger TQL Editor.</p> <p>A small green indicator  appears next to the tabs in which a change occurred.</p> |
| Included in Tasks | <ul style="list-style-type: none"> ➤ “Define a Correlation Rule – Workflow” on page 179 ➤ “Define an Enrichment Rule – Scenario” on page 300 ➤ “Define a TQL Query” on page 328 ➤ “Create a Pattern View” on page 144 ➤ “Define a Report Rule – Scenario” on page 246 |

The following elements are included (unlabeled GUI elements are shown in angle brackets>):

| GUI Element (A-Z) | Description |
|---|---|
|  | If the window is not wide enough to display all the tabs, use the left and right arrows to move to the required tab. |
|  | Click Show List to display a list of the available tabs for the current manager. You can select a tab from the list. |
| Affected Nodes | Displays which node is affected by the changes that occur in the selected trigger node. If required, you can click Edit to open and modify the Affected Nodes dialog box. For details, see “Affected Nodes Dialog Box” on page 186. Note: This tab appears only in Correlation Manager. |
| Attributes | Displays the attribute conditions defined for the node or the relationship. For details, see “Attribute Tab” on page 377. |
| Cardinality | Cardinality defines how many nodes you expect to have at the other end of a relationship. For example, in a relationship between host and IP, if the cardinality is 1:3, the TQL retrieves only those hosts that are connected to between one and three IPs. For details, see “Cardinality Tab” on page 379. |
| Details | Displays the following information: <ul style="list-style-type: none"> ➤ CI Type. The CIT of the selected node/relationship. ➤ Visible. A green check indicates that the selected node/relationship is visible in the topology map. A red mark indicates that it is not visible. ➤ Include subtypes. A green check indicates that both the selected CI and its children are displayed in the topology map. A red mark indicates that only the selected CI appears. |
| Edit | Click Edit to open the relevant dialog box for the selected tab. |

| GUI Element (A-Z) | Description |
|----------------------------|---|
| Enrichment Rules | <p>Displays the Enrichment rule defined for the selected node or relationship. If the Enrichment rule is used to update the attributes of a CI, click Edit to open the Node/Relationship Definition dialog box and edit the rule if required. For details, see “Node/Relationship Definition Dialog Box” on page 318.</p> <p>Note: This tab appears only in Enrichment Manager.</p> |
| Folding Rule | <p>Displays the folding rule defined for the selected relationship. For details about folding rules, see “Adding Folding Rules to Relationships” on page 44.</p> <p>Note: This tab appears only when a relationship is selected in View Manager.</p> |
| Grouping | <p>Displays the different CI groupings for the selected node, as defined in the Grouping dialog box.</p> <p>Note: This tab appears only in View Manager.</p> |
| Node Definition | <p>Displays the attributes to be included in the report for the selected node. If required, you can click Edit to open and modify the Report Node definition dialog box. For details, see “Report Node Definition Dialog Box” on page 276.</p> <p>Note: This tab appears only in Topology Report Manager.</p> |
| Qualifiers | <p>Displays the qualifier conditions defined for the node or the relationship. For details, see “Qualifier Tab” on page 382.</p> |
| Rule | <p>Displays the report folding rule defined for the selected relationship. For details about folding rules, see “Editing Pane” on page 270.</p> <p>Note: This tab appears only when a relationship is selected in Topology Report Manager.</p> |
| Selected Identities | <p>Displays the element instances that are used to define what should be included in the TQL results. For details, see “Identity Tab” on page 384.</p> |

 **Details Dialog Box**

| | |
|--------------------------|--|
| Description | Displays the new Correlation rule you created in the Correlation Definition dialog box. To access: Click Next in the Affected Nodes dialog box. |
| Included in Tasks | “Define a Correlation Rule – Workflow” on page 179 |

The following elements are included (unlabeled GUI elements are shown in angle brackets>):

| GUI Element (A-Z) | Description |
|--------------------------|---|
| Description | The description of the new Correlation rule. |
| State | The category you chose from the State list in the Correlation Definition dialog box. |

New Correlation Rule/Correlation Rule Properties/Save As Correlation Rule Wizard

| | |
|------------------------------|---|
| Description | <p>Creates or modifies a Correlation rule.</p> <p>To access:</p> <ul style="list-style-type: none"> ▶ To create a Correlation rule, right-click anywhere in the Correlation Rules pane and click New or click the New  button. ▶ To modify a Correlation rule, right-click a Correlation rule in the Correlation Rules pane and select Properties. ▶ To create a new Correlation rule based on an existing query, right-click a Correlation rule in the Correlation Rules pane and select Save As. |
| Important Information | <ul style="list-style-type: none"> ▶ Any major changes made to the TQL query after creating a Correlation rule causes the system to delete the rule. These changes include deleting a root cause or affected node or changing the Min and Max relationship definitions (for details, see “Cardinality Tab” on page 379). ▶ Minor changes, such as adding a node to the TQL, do not cause the deletion of the rule. ▶ The Correlation TQL that serves as the basis of the Correlation rule, is subject to certain validation restrictions. For details, see “Troubleshooting and Limitations” on page 401. If the TQL is not valid, it cannot be used for the creation of a Correlation rule. |
| Included in Tasks | “Define a Correlation Rule – Workflow” on page 179 |
| Wizard Map | <p>The New Correlation Rule/Correlation Rule Properties/Save As Correlation Rule Wizard contains:</p> <p>Rule General Attributes Page > Rule Base TQL Page > Rule Groups Page</p> |

 **Rule General Attributes Page**

| | |
|------------------------------|---|
| Description | Enables you to enter a unique name and description for the Correlation rule. |
| Included in Tasks | “Define a Correlation Rule – Workflow” on page 179 |
| Important Information | <ul style="list-style-type: none"> ▶ The Correlation TQL that serves as the basis of the Correlation rule, is subject to certain validation restrictions. For details, see “Troubleshooting and Limitations” on page 401. If the TQL is not valid, it cannot be used for the creation of a Correlation rule. ▶ For important information on the effects of making changes to the TQL after creating it, see “New Correlation Rule/Correlation Rule Properties/Save As Correlation Rule Wizard” on page 199. ▶ By default, this wizard is set to display a Welcome page. You can choose not to display the Welcome page by changing the user preferences. For details, see “User Preferences Dialog Box” on page 400. |
| Useful Links | “Topology Query Language” on page 323 |
| Wizard Map | The New Correlation Rule/Correlation Rule Properties/Save As Correlation Rule Wizard contains: Rule General Attributes Page > Rule Base TQL Page > Rule Groups Page |

The following elements are included (unlabeled GUI elements are shown in angle brackets>):

| GUI Element (A-Z) | Description |
|--------------------------|---|
| Description | (Optional) Enter a description of the rule. |
| Rule Name | <p>Enter a unique name for the Correlation rule.</p> <p>The rule name cannot contain any of the following characters: \ / : " < > % ?</p> <p>Note: If the Correlation rule name is either empty, contains a name used by another Correlation rule, or uses invalid characters, the Next and Finish buttons are disabled.</p> |

 **Rule Base TQL Page**

| | |
|------------------------------|---|
| Description | Enables you to define the properties of the TQL on which the Correlation rule is based. |
| Included in Tasks | “Define a Correlation Rule – Workflow” on page 179 |
| Important Information | <ul style="list-style-type: none"> ▶ The Correlation TQL that serves as the basis of the Correlation rule, is subject to certain validation restrictions. For details, see “Troubleshooting and Limitations” on page 401. If the TQL is not valid, it cannot be used for the creation of a Correlation rule. ▶ For important information on the effects of making changes to the TQL after creating it, see “New Correlation Rule/Correlation Rule Properties/Save As Correlation Rule Wizard” on page 199. |
| Useful Links | “Topology Query Language” on page 323 |
| Wizard Map | The New Correlation Rule/Correlation Rule Properties/Save As Correlation Rule Wizard contains: Rule General Attributes Page > Rule Base TQL Page > Rule Groups Page |

The following elements are included (unlabeled GUI elements are shown in angle brackets>):

| GUI Element (A-Z) | Description |
|---|---|
| Base the Correlation rule on a new TQL | Select this check box if you want to base the Correlation rule on a new TQL query. The TQL results are based on the attributes defined for the new TQL query. |
| Base the Correlation rule on an existing TQL | Select this check box if you want to base the Correlation rule on an existing TQL query. Select the required Correlation TQL query from the drop-down list. |
| Base TQL Description | (Optional) Enter a description of the TQL query. |

| GUI Element (A-Z) | Description |
|--------------------------|--|
| Base TQL Name | Enter a unique name for the Correlation TQL query. If you selected the Base the Correlation rule on an existing TQL option, select the Correlation TQL query on which you want to base the rule. |
| Base TQL Priority | Select a priority level for the new TQL query (Low, Medium, High, Express). This setting determines how often the query is rerun automatically by the system to include updated information from the CMDB. |

Rule Groups Page

| | |
|------------------------------|---|
| Description | Enables you to define where you can run Correlation rules. |
| Included in Tasks | “Define a Correlation Rule – Workflow” on page 179 |
| Important Information | <ul style="list-style-type: none"> ▶ The Correlation TQL that serves as the basis of the Correlation rule, is subject to certain validation restrictions. For details, see “Troubleshooting and Limitations” on page 401. If the TQL is not valid, it cannot be used for the creation of a Correlation rule. ▶ For important information on the effects of making changes to the TQL after creating it, see “New Correlation Rule/Correlation Rule Properties/Save As Correlation Rule Wizard” on page 199. ▶ By default, this wizard is set to display a Completion page after clicking Next in this page. You can choose not to display the Completion page by changing the user preferences. For details, see “User Preferences Dialog Box” on page 400. |
| Useful Links | “Topology Query Language” on page 323 |
| Wizard Map | The New Correlation Rule/Correlation Rule Properties/Save As Correlation Rule Wizard contains: Rule General Attributes Page > Rule Base TQL Page > Rule Groups Page |

The following elements are included (unlabeled GUI elements are shown in angle brackets>):

| GUI Element (A-Z) | Description |
|-------------------|--|
| Others | Currently not supported. |
| UCMDB | Enables you to run a Correlation rule in the Topology View Application tab. For details, see “Topology View Overview” on page 516. |

6

CI Type Manager

This chapter provides information on CI Type Manager.

Note to HP Software-as-a-Service customers: The data in CI Type Manager can be viewed but not edited.

This chapter includes:

Concepts

- CI Types Overview on page 206
- CI Type Attributes on page 207
- CI Type Relationships on page 208
- System Type Manager on page 208

Tasks

- Create a CI Type on page 209
- Create a Relationship Type on page 210
- Create a Calculated Relationship Type on page 212
- Create List and Enumeration Definitions on page 213
- Enumeration Definition – Workflow on page 214

Reference

- View Descriptions for CI Types and Relationships on page 216
- CI Type Manager User Interface on page 216

CI Types Overview

A configuration item (CI) can represent hardware, software, services, business processes, or any component of your IT infrastructure. CIs with similar properties are grouped under a CI type (CIT). Each CIT provides a template for creating a CI and its associated properties.

Every CI must belong to a CI type. The following are the main categories of CITs:

- ▶ **Business.** CITs that correspond to the logical elements of your business, such as processes and organizational groups.
- ▶ **IT Process.** CITs that correspond to changes that occur in your IT infrastructure.
- ▶ **Monitor.** CITs that handle incoming metrics collected from your business universe.
- ▶ **System.** CITs that correspond to the physical elements (hardware and software) installed in your business environment.

The CITs are arranged in a tree structure under these categories in the CI Types pane. You can browse the CI Type model by expanding the tree in the CI Types pane. The CIT selected in the left pane is displayed in the topology map along with all the potential valid relationships to other CITs.

You can also define new CITs to match your business needs. For details on defining new CITs, see “Create Configuration Item Type/Relationship/Calculated Relationship Wizard” on page 226.

CI Type Attributes

Every CI type has attributes which define it such as name, description, and default value. The CITs grouped under other CITs in the CI Type tree inherit attributes from the higher-level CITs.

When you define a new CI type, you first select a Base Configuration Item Type from a list of existing CITs. Your new CIT inherits the attributes of the existing CIT. You can then set the attributes for the new CIT. You edit the attributes of an existing CIT by selecting a CIT from the tree in the CI Types pane and selecting the Attributes tab of the topology map. For details on CIT attributes, see “Attributes Page” on page 228.

Every CIT must have at least one key attribute. A key attribute is an attribute that is used as an identifier of the CIT. When you define an instance of a CIT, the CIT's key attributes are mandatory fields for CIs of that type. You can assign as many key attributes as you want to a given CIT. If you do not assign a key attribute when defining a new CIT, the CIT is created, but it remains abstract, that is, you are unable to create instances of it (you are prompted to include the ABSTRACT_CLASS qualifier on the Qualifier page of the wizard).

Entity names in HP Universal CMDB for CMDB-based applications follow the conventions described below:

- ▶ **CIT attributes values.** All primitive types are supported: long, double, float, string, and so on.
- ▶ **CIT attributes values-type string.** All special characters are supported. The maximum length is 4000 characters.
- ▶ **CIT names and attributes names.** The following are permitted: a-z, A-Z, and underscore (_). The length is limited to 200 characters. The CIT name must be in English.
- ▶ **CIT attribute length.** The total length of all the attributes in one CIT cannot exceed 8K due to a Microsoft SQL Server limitation.

CI Type Relationships

A relationship defines the link between two CIs. Relationships represent the dependencies and connections between the entities in your IT environment. When you select relationships or calculated relationships in the drop-down box in the CI Types pane, the topology map displays all the valid instances of CITs linked by the selected relationship. For details about calculated relationships, see “Using Calculated Relationships” on page 407.

The same attributes defined for CITs are also defined for relationships. You can also assign key attributes for relationships but it is not required. For details on defining new relationship types, see “Create Configuration Item Type/Relationship/Calculated Relationship Wizard” on page 226.

System Type Manager

System Type Manager enables you to create a predefined list whose values define an attribute type. For more details on System Type Manager, see “System Type Manager Dialog Box” on page 243.

You can create the following attribute types:

- ▶ **List.** Enables you to create a predefined list of values, for example, Location.
- ▶ **Enumeration.** Enables you to create a predefined list of values, as well as assign each value a color. Enumerations are designed to be used as severity value lists by states. For details, see “State Manager” on page 499.

Severity lists are used for:

- ▶ Retrieving Correlation results in Topology View Application. For details, see “Topology View Application” on page 515.
- ▶ Creating a Correlation rule. For details, see “Correlation Manager” on page 177.

You can use both List and Enumeration values for:

- ▶ Editing the attributes of a CIT. For details, see “Create a CI Type” on page 209.

- Defining an attribute condition for a TQL node or relationship. For details, see “Node/Relationship Properties Dialog Box” on page 375.

Create a CI Type

This task describes the process you follow to create a CIT using the Create CI Type wizard.

This task includes the following steps:

- “Prerequisites” on page 209
- “Define the CI Type” on page 209
- “Set the CI Type Attributes” on page 209
- “Assign Qualifiers to the CI Type” on page 210
- “Assign an Icon to the CI Type” on page 210
- “Customize the CI Type Menu” on page 210
- “Define the CI Type Default Label” on page 210

1 Prerequisites



From the CI Type Manager, select **CI Types** from the list box in the CI Types pane. Then select **New** to start the Create CI Type Wizard.

2 Define the CI Type

Enter the name, description and base configuration item type for the new CI type. For details, see “Details Page” on page 227.

3 Set the CI Type Attributes

Edit the attributes of the new CI type and define key attributes for it. For details, see “Attributes Page” on page 228.

Note: List and Enumeration definitions are created in the System Type Manager. If required, you can create additional List and Enumeration definitions. For details, see “Create List and Enumeration Definitions” on page 213.

4 Assign Qualifiers to the CI Type

Assign qualifiers to the definition of the new CI type. For details, see “Qualifiers Page” on page 230.

5 Assign an Icon to the CI Type

Select an icon to assign to the new CI type. For details, see “Icon Page” on page 233.

6 Customize the CI Type Menu

Select the menu items and commands to appear in the shortcut menu for the new CI type. For details, see “Attached Menu Page” on page 235.

7 Define the CI Type Default Label

Define the attributes to appear in the CI type label. For details, see “Default Label Page” on page 238.

Create a Relationship Type

This task describes the process you follow to create a relationship type using the Create Relationship wizard.

This task includes the following steps:

- “Prerequisites” on page 211
- “Define the Relationship” on page 211
- “Set the CI Type Attributes” on page 211

- “Assign Qualifiers to the Relationship” on page 211
- “Customize the Relationship Menu” on page 211
- “Define the Relationship Default Label” on page 212

1 Prerequisites



From the CI Type Manager, select **Relationships** from the list box in the CI Types pane. Then select **New** to start the Create Relationship Wizard.

2 Define the Relationship

Enter the name, description and base CI type for the new relationship. For details, see “Details Page” on page 227.

3 Set the CI Type Attributes

Edit the attributes of the new relationship and define key attributes for it. For details, see “Attributes Page” on page 228.

Note: List and Enumeration definitions are created in the System Type Manager. If required, you can create additional List and Enumeration definitions. For details, see “Create List and Enumeration Definitions” on page 213.

4 Assign Qualifiers to the Relationship

Assign qualifiers to the definition of the new relationship. For details, see “Qualifiers Page” on page 230.

5 Customize the Relationship Menu

Select the menu items and commands to appear in the shortcut menu for the new relationship. For details, see “Attached Menu Page” on page 235.

6 Define the Relationship Default Label

Define the attributes to appear in the relationship label. For details, see “Default Label Page” on page 238.

Create a Calculated Relationship Type

This task describes the process you follow to create a calculated relationship type using the Create Calculated Relationship wizard.

This task includes the following steps:

- “Prerequisites” on page 212
- “Define the Calculated Relationship” on page 212
- “Assign Qualifiers to the Relationship” on page 212
- “Add Required Triplets” on page 212

1 Prerequisites



From the CI Type Manager, select **Calculated Relationships** from the list box in the CI Types pane. Then select **New** to start the Create Calculated Relationship Wizard.

2 Define the Calculated Relationship

Enter the name, description and base CI type for the new calculated relationship. For details, see “Details Page” on page 227.

3 Assign Qualifiers to the Relationship

Assign qualifiers to the definition of the new relationship. For details, see “Qualifiers Page” on page 230.

4 Add Required Triplets

Add the required triplets. For details, see “Triplets Page” on page 232.

Create List and Enumeration Definitions

This section describes the tasks for creating List and Enumeration definitions.

This task includes the following steps:

- “Create a List Definition” on page 213
- “Create an Enumeration Definition” on page 213

1 Create a List Definition

You can create a **List** definition of predefined values. For example, a List definition called Location might contain:

- New York
- Boston
- Baltimore

For details, see “Create/Update List/Enumeration Definition Dialog Box” on page 240.

2 Create an Enumeration Definition

You can create an **Enumeration** definition, which enables you to assign a color for each value on the list. For details, see “Create/Update List/Enumeration Definition Dialog Box” on page 240. For an example of an Enumeration definition, see “Enumeration Definition – Workflow” on page 214.

Enumeration Definition – Workflow

The following steps describe how to create an Enumeration definition.

Note: To retrieve the required results, you must follow each step in this task.

To create an Enumeration definition:

- 1** Select **Admin > Modeling > CI Type Manager**.
- 2** From the Main Menu, select **CI Types > System Type Manager** to open the System Type Manager dialog box.
- 3** Click the **Add** button to open the Create List Definition dialog box.

Note: Alternatively, you can select **Admin > Settings > State Manager** and then click the **New Enumeration** button to open the Create Enumeration Definition dialog box.

- 4** Select **Enumeration**.
- 5** In the **Name** box, enter the required name.
- 6** (Optional) In the **Display Name** box, enter the required display name.

This example describes how to create the following severity list:

| Key | Value | Severity Represented |
|-----|--------|----------------------|
| 0 | Green | Normal |
| 1 | Orange | Major |
| 2 | Red | Critical |

-  **7** Click the **Add** button to create a new row.
- 8** In the **Value** box, enter Normal.
- 9** In the **Key** box, enter 0.

- 10 In the **Color** section, select **Green**.
- + 11 Click the **Add** button to create another row.
- 12 In the **Value** box, enter Major.
- 13 In the **Key** box, enter 1.
- 14 In the **Color** section, select **Orange**.
- + 15 Click the **Add** button to create another row.
- 16 In the **Value** box, enter Critical.
- 17 In the **Key** box, enter 2.
- 18 In the **Color** section, select **Red**.

The following image shows the Enumeration Definition section after the changes:

The screenshot shows the 'Enumeration Definition' dialog box for 'Oper_States'. The 'Name' field contains 'Oper_States' and the 'Display Name' field is empty. The 'Enumeration' radio button is selected. The 'Enumeration Definition' section shows a list of three items: 'Normal', 'Major', and 'Critical'. The 'Critical' item is selected. To the right of the list, the 'Value' field contains 'Critical' and the 'Key' field contains '2'. The 'Color' section shows a list of color options: Green (checked), Light Olive, Yellow, Orange, Red (checked), and Gray.

- 19 Click **OK** to save your changes.

View Descriptions for CI Types and Relationships

You can view a complete list of available CI types in tree format in the left pane of CI Type Manager. You can search incrementally for a specific CI type as described in “CI Type Manager” on page 221. To see a description for a particular CI type, select it from the tree and hold the pointer over the icon which corresponds to it in the Topology Map. A tooltip containing a description of the CI type is displayed.

For relationships, select **Relationships** in the left pane and search incrementally by the first letter of the relationship. Select the relationship you want and hold the pointer over its icon in the Topology Map to display a tooltip containing a description of the relationship.

You can also view a list of relationships in “Relationship Definitions” in *Reference Information*.

CI Type Manager User Interface

This section describes:

- ▶ Add/Edit Attribute Dialog Box on page 217
- ▶ Add/Remove Relationship Dialog Box on page 221
- ▶ CI Type Manager on page 221
- ▶ Create Configuration Item Type/Relationship/Calculated Relationship Wizard on page 226
- ▶ Create/Update List/Enumeration Definition Dialog Box on page 240
- ▶ System Type Manager Dialog Box on page 243

Add/Edit Attribute Dialog Box

| | |
|------------------------------|--|
| Description | <p>Enables you to define a new attribute to add to a CIT or to edit an existing attribute of a CIT.</p> <p>To access: In the CIT Manager, select the Attributes tab, then click the Add  button, or select an attribute and click the Edit button or double-click the attribute.</p> |
| Important Information | In Edit mode, fields that cannot be changed are disabled. |

Details Tab

The following elements are included (unlabeled GUI elements are shown in angle brackets>):

| GUI Element (A-Z) | Description |
|-----------------------|--|
| Attribute Name | <p>Enter a unique name for the new attribute. The name can contain all characters except the following: " \ / [] : < > + = ; , ? *</p> <p>Note: The attribute name is not case sensitive.</p> |
| Attribute Type | <p>Select one of the following options:</p> <ul style="list-style-type: none"> ▶ Primitive. Choose from one of the following field types: boolean, bytes, date, double, float, integer, integer_list, long, string, string_list, xml. ▶ Enumeration/List. Contains a list of Enumerations and Lists defined in the System Type Manager. For details, see “System Type Manager” on page 208. <p>This option enables you to define an attribute with a predefined value. For example, a location attribute might be defined by a location list containing the following values: Singapore, Paris, New York.</p> |
| Default Value | <p>Enter or select a default value for the attribute. The options for the Default Value field vary depending on the attribute type you selected.</p> <p>Note: If you select the integer_list or string_list Primitive attribute type, you can enter multiple values.</p> |

| GUI Element (A-Z) | Description |
|---------------------|---|
| Description | Enter a description for the new attribute. Note: This field is optional. |
| Display Name | Enter a name for the new attribute to identify it in HP Universal CMDB. Note: This field is optional. |
| Value Size | Enter a value for the maximum physical size of the new attribute. (Enabled for bytes and string only). |

Advanced Tab

The following elements are included (unlabeled GUI elements are shown in angle brackets>):

| GUI Element (A-Z) | Description |
|------------------------|---|
| <Advanced tab options> | <p>You can set the following optional parameters:</p> <ul style="list-style-type: none"> ▶ Visible. Select to display this attribute in the Properties tab in IT Universe Manager. ▶ Editable. Select to enable future editing of the attribute. Only attributes that are marked as Editable (or ones that have values) are displayed in the Properties tab in IT Universe Manager. ▶ Comparable. Select to enable this attribute to be used for comparing compound CIs. ▶ Required. Select to define this attribute as a required one, if its value is required for the creation of the CIT. ▶ Index. Select to accelerate the attribute retrieval performance. This option is recommended for attributes that are used frequently in search conditions. For example, IP address is usually an index attribute of a host. ▶ Change Monitored. Select to define attributes whose values are being marked as Change Monitored in CI Type Manager. For every change in an attribute defined as Change Monitored, you are notified by a Change event in the Topology View. ▶ Enable Auto Truncate by DDM. For details, see “Data Validation on the DDM Probe” in <i>Discovery and Dependency Mapping Guide</i>. ▶ Upper Case. When this option is selected, the attribute value appears in upper case. ▶ Lower Case. When this option is selected, the attribute value appears in lower case. ▶ Static. Select to define this attribute as static. ▶ Asset Data. Select to display the attribute value in the Asset Report. ▶ Password. When this option is selected, the attribute value appears as asterisks (a hidden value). ▶ Unique. When this option is selected, different instances of this CI type must have unique values. |

Add/Remove Relationship Dialog Box

| | |
|------------------------------|--|
| Description | <p>Enables you to add or remove default or new relationships between CITs, which define their physical or logical connections.</p> <p>To access: In the CIT Manager, right-click a CIT or two CITs and select Add/Remove Relationship from the context menu.</p> |
| Important Information | <p>When adding a relationship between two CITs, select the two CITs to be linked by holding down CTRL and clicking the CIT names. Then right-click one of them to display the context menu and select Add/Remove Relationship.</p> |







The following elements are included (unlabeled GUI elements are shown in angle brackets):

| GUI Element (A-Z) | Description |
|-------------------|---|
| <node1 to node2> | Select the relationships to add in the direction of the first node to the second. |
| <node2 to node1> | Select the relationships to add in the direction of the second node to the first. |
| Relationship Name | A list of the possible relationships. |

CI Type Manager

| | |
|--------------------|---|
| Description | <p>Enables you to view the information in the CI Type model, which contains the definitions of all configuration item types (CITs) defined in the system and the relationships that define the connections between them. Each CIT has its own attributes, as well as the attributes inherited from its parent CIT.</p> <p>To access: Select Admin > Modeling > CI Type Manager.</p> |
|--------------------|---|

The following elements are included (unlabeled GUI elements are shown in angle brackets):

| GUI Element (A-Z) | Description |
|---|--|
|  | Click the New button to open the Create Configuration Item Type Wizard which enables you to define a new CI type. For details, see “Create Configuration Item Type/Relationship/Calculated Relationship Wizard” on page 226. |
|  | Click Delete to delete the selected CI type or relationship. |
|  | Click to refresh the data content of the hierarchical tree structure that may have been modified by other users. |
|  | Click the Save button to save changes made to a CI type. |
|  | Enables you to import CITs from an external file. |
|  | Enables you to export a CIT as an XML file. Use this option to move CITs from one server to another. |
| <CI Type/Relationship Box> | Select one of the following options: <ul style="list-style-type: none"> ➤ CI Types. Display the CI types in the CIT model. ➤ Relationships. Display the relationships in the CIT model. ➤ Calculated Relationships. Display the calculated relationships in the CIT model. |
| <Main Menu> | For details, see “Main Menu” on page 713. |
| <Toolbar> | For details, see “Toolbar Options” on page 717. |

| GUI Element (A-Z) | Description |
|----------------------|--|
| CI Types Pane | <p>A hierarchical tree structure of the CI Type model containing the inheritance relationships among CITs, and displaying the number of instances of each CIT in the UCMDB. All CITs included in the CI Type model are classified as either a CIT or a relationship. You can drill down and view the relationships and neighbors of the selected CIT in the topology map. You can search in the list of CITs or relationships using the Incremental Search by entering the first letter of the CIT or relationship repeatedly until you reach the required selection. You can also search for a CIT or relationship by entering its full name.</p> <p>Note: Each CI type is represented by a unique icon. (If an icon has not been defined for the CIT, it takes the icon of its parent.)</p> |

| GUI Element (A-Z) | Description |
|--------------------|---|
| Main Window | <p>The following tabs are available:</p> <ul style="list-style-type: none"> ▶ Dependencies. Displays the CI Type model in a topology map, including the CITs and the relationships between them. The name of the selected CI type or relationship appears in the border at the top of the pane. When you point to a CIT, a tooltip displays the display name of the CIT and its description. ▶ Details. Enables you to edit the basic information about the CI type selected in the left pane. For details, see “Details Page” on page 227. ▶ Attributes. Enables you to edit the attributes of the selected CIT. For details, see “Attributes Page” on page 228. ▶ Qualifiers. Enables you to assign qualifiers to the selected CIT. For details, see “Qualifiers Page” on page 230. ▶ Triplets. Enables you to create a calculated relationship. For details, see “Triplets Page” on page 232. This page appears only for calculated relationships. ▶ Icon. Enables you to assign an icon to the selected CIT. For details, see “Icon Page” on page 233. This tab does not appear for relationships. ▶ Attached Menu. Enables you to customize the shortcut menu of a CI by adding menu items and commands (for example, ping, run a program, open a URL). The customized menu is displayed when you right-click a CI instance in IT Universe Manager. For details, see “Attached Menu Page” on page 235. ▶ Default Label. Enables you to define attributes that appear in the CIT label. You can include more than one attribute by using the function buttons. For details, see “Default Label Page” on page 238. |

Context Menu

CI Type Manager includes the following context menu options available by right clicking a CI type in the CI Types pane or the Dependencies map:

| GUI Element (A-Z) | Description |
|--------------------------------|---|
| Add/Remove Relationship | Opens the Add/Remove Relationship dialog box, which enables you to add or remove relationships from CITs. For details, see “Add/Remove Relationship Dialog Box” on page 221. |
| Delete | Deletes the selected CI type. This option is only available for CI types that have no children and no instances. |
| Export | Enables you to export a CIT as an XML file. Use this option to move CITs from one server to another. |
| New | Opens the Create Configuration Item Type Wizard which enables you to define a new CI type. For details, see “Create Configuration Item Type/Relationship/Calculated Relationship Wizard” on page 226. |
| Show CIT Instances | Opens the Show All Instances window, which displays all instances of the selected CIT. For details, see “Element Instances Dialog Box” on page 368. |

Create Configuration Item Type/Relationship/Calculated Relationship Wizard

| | |
|--------------------|--|
| Description | <p>Enables you to define a new configuration item type or relationship.</p> <p>To access:</p> <ul style="list-style-type: none"> ▶ Click a CI type or relationship in the topology map or CI Types pane of the CIT Manager and select New from the context menu. ▶ Click the New button  in the CI types pane. |
| Wizard Map | <p>The Create Configuration Item Type/Relationship/Calculated Relationship Wizard contains:</p> <p>Details Page > Attributes Page > Qualifiers Page > Triplets Page > Icon Page > Attached Menu Page > Default Label Page</p> |

The Create Configuration Item Type wizard includes the following pages:

- ▶ “Details Page” on page 227
- ▶ “Attributes Page” on page 228
- ▶ “Qualifiers Page” on page 230
- ▶ “Triplets Page” on page 232
- ▶ “Icon Page” on page 233
- ▶ “Attached Menu Page” on page 235
- ▶ “Default Label Page” on page 238

 **Details Page**

| | |
|------------------------------|---|
| Description | Enables you to enter basic information about the new CI type you are defining. |
| Important Information | For general information about the Create Configuration Item Type Wizard, see “Create Configuration Item Type/Relationship/Calculated Relationship Wizard” on page 226. |
| Wizard Map | The Create Configuration Item Type/Relationship/Calculated Relationship Wizard contains: Details Page > Attributes Page > Qualifiers Page > Triplets Page > Icon Page > Attached Menu Page > Default Label Page |





The following elements are included (unlabeled GUI elements are shown in angle brackets>):



| GUI Element (A-Z) | Description |
|---------------------|--|
| Base CI Type | Select a base CIT for the CIT you are creating. The new CIT inherits the base CIT’s attributes. Note: This field only appears in the Create CI Type Wizard. It is not relevant when editing an existing CIT in the Details tab of CI Type Manager. |
| Description | A description for the new CIT. Note: This field is optional. |
| Display Name | The name of the CIT as it appears in the HP Universal CMDB interface. |
| Name | The unique name of the new CIT. The name can contain all characters except the following: " \ / [] : < > + = ; , ? * Note: The name field is case sensitive, but you cannot use the same name with different cases for two different CITs. |

Attributes Page

| | |
|--------------------|---|
| Description | Enables you to edit the attributes of the CIT. |
| Wizard Map | The Create Configuration Item Type/Relationship/Calculated Relationship Wizard contains: Details Page > Attributes Page > Qualifiers Page > Triplets Page > Icon Page > Attached Menu Page > Default Label Page |

The following elements are included (unlabeled GUI elements are shown in angle brackets>):

| GUI Element (A-Z) | Description |
|---|---|
|  | <p>To define an attribute as a key attribute, click in the left column beside the attribute name. A key icon appears in the cell. A key attribute is an attribute that must be defined for CIs of that CI type.</p> <p>To remove the key attribute definition, click in the left column again. The key icon disappears.</p> <p>For more information on key attributes, see “CI Type Attributes” on page 207.</p> |
|  | <p>Denotes a static attribute. A static attribute takes the same value for all the CIs of that type. If it is changed, all the CIs of that type are affected and automatically display the new value. A static attribute cannot be defined as a key attribute.</p> <p>Note: You cannot define an attribute as static from within the CIT Manager. It is done by deploying the relevant package. Static attributes are for internal use only.</p> |
|  | <p>Click the Add button to define a new attribute. For details, see “Add/Edit Attribute Dialog Box” on page 217.</p> |
|  | <p>Select a row and click the Edit button to open the Edit Attribute dialog box. For details, see “Add/Edit Attribute Dialog Box” on page 217.</p> <p>Note: If you modify an attribute belonging to a CIT’s parent, the text turns light blue. If you modify an attribute belonging to the CIT itself, the text turns dark blue.</p> |





| GUI Element (A-Z) | Description |
|---|--|
|  | Click the Delete button to delete a selected attribute. This option is only active for newly defined attributes. |
|  | Click the Reset button to reset the attribute settings after editing a pre-existing attribute. |
|  | Click Select Columns to select the columns to appear using the Select Columns dialog box. |
| <Attributes> | Displays all attributes associated with the new CIT. Attributes appearing in black are ones that the new CIT inherits from the base CIT. Attributes appearing in blue are ones that are private to this CIT and its descendants. Attributes appearing in light blue are inherited ones that have been modified for the new CIT. |
| Asset Data | Select to display the attribute value in the Asset Report. For details see “Asset Report User Interface” on page 577. Note: When this qualifier is selected for a given attribute, the attribute appears as a visible column in the Element Instances dialog box. For details, see “Element Instances Dialog Box” on page 368. |
| Change Monitored | Select to define attributes whose values are being marked as Change Monitored in CI Type Manager. Note: When this qualifier is selected for a given attribute, the attribute appears as a visible column in the Element Instances dialog box. For details, see “Element Instances Dialog Box” on page 368. |
| Comparable | Select to enable this attribute to be used for comparing compound CIs. For details, see “Compare CIs User Interface” on page 569. Note: When this qualifier is selected for a given attribute, the attribute appears as a visible column in the Element Instances dialog box. For details, see “Element Instances Dialog Box” on page 368. |
| Default Value | The default value for the attribute. This value appears when the new CIT is defined and there is no runtime value for the attribute. |

| GUI Element (A-Z) | Description |
|---------------------|--|
| Description | A description of the attribute. |
| Display Name | The attribute name that appears in the HP Universal CMDB interface. |
| Editable | Select to enable future editing of the attribute. Only attributes that are marked as Editable (or ones that have values) are displayed in the Properties tab in IT Universe Manager. |
| Index | Select to accelerate the attribute retrieval performance. This option is recommended for attributes that are used frequently in search conditions. For example, IP address is usually an index attribute of a host. |
| Lower Case | Select to keep the attribute value in lower case. |
| Name | The actual name of the attribute (compare to Display Name). |
| Required | Select to define this attribute as a required one, if its value is required for the creation of the CIT. |
| Type | The type of the attribute. |
| Visible | Select to display this attribute in the Properties tab in IT Universe Manager. |

 **Qualifiers Page**

| | |
|------------------------------|---|
| Description | Enables you to assign qualifiers to a CIT definition. |
| Important Information | Qualifiers enable you to define added attribute definitions to the CIT. In the Qualifiers list, select the required qualifiers using the Add buttons to move your selections to the Configuration Item Type Qualifiers list. You can make multiple selections by holding down the CTRL key. |
| Wizard Map | The Create Configuration Item Type/Relationship/Calculated Relationship Wizard contains: Details Page > Attributes Page > Qualifiers Page > Triplets Page > Icon Page > Attached Menu Page > Default Label Page |



The following elements are included (unlabeled GUI elements are shown in angle brackets):



| GUI Element (A-Z) | Description |
|---|---|
|  | Click this button to move all qualifiers to the Configuration Item Type Qualifiers list. |
|  | Select the qualifier and click this button to add the qualifier to the Configuration Item Type Qualifiers list. Select multiple qualifiers by holding down the CTRL key. |
|  | To remove a qualifier from the CIT definition, select the qualifier from the Configuration Item Type Qualifiers list and click this button. |
|  | Click this button to remove all qualifiers from the Configuration Item Type Qualifiers list |
|  | To define a new, custom qualifier, enter the qualifier name in the window and click Insert . The qualifier appears in the Configuration Item Type Qualifiers list. |
| < Configuration Item Type Qualifiers > | The list of qualifiers that define attributes of the new CIT. For example, you can use a qualifier to define a CIT as abstract, which means that you cannot create instances from it. |
| < Qualifiers > | For a list of the available qualifier options, see “Qualifier Tab” on page 382. |

Triplets Page

| | |
|------------------------------|---|
| Description | <p>Enables you to create a calculated relationship.</p> <p>Each row on the Triplets page represents one of the allowed steps in the path leading from the source CI to the target CI in the topology map.</p> <p>Note: This step of the wizard is relevant only for calculated relationships.</p> |
| Important Information | <ul style="list-style-type: none"> ▶ For details about calculated relationships, see “Using Calculated Relationships” on page 407. ▶ For general information about the Create Configuration Item Type Wizard, see “Create Configuration Item Type/Relationship/Calculated Relationship Wizard” on page 226. |
| Useful Links | “Using Calculated Relationships” on page 407 |
| Wizard Map | <p>The Create Configuration Item Type/Relationship/Calculated Relationship Wizard contains:</p> <p>Details Page > Attributes Page > Qualifiers Page > Triplets Page > Icon Page > Attached Menu Page > Default Label Page</p> |

The following elements are included (unlabeled GUI elements are shown in angle brackets>):



| GUI Element (A-Z) | Description |
|---|--|
|  | Click to define the allowed steps in a path in the topology graph leading from the source CI to the target CI in the calculated relationship. Opens the Add Triplet dialog box. For details, see “Add Triplet Dialog Box” on page 364. |
|  | Select a row and click the Edit button to edit the triplet. Opens the Edit Triplet dialog box. For details, see “Add Triplet Dialog Box” on page 364. |
|  | Click the Delete button to delete a selected triplet. |
| Relationship | The required relationship connecting the two nodes. |

| GUI Element (A-Z) | Description |
|-------------------------------|---|
| Relationship Direction | <p>The required relationship direction.</p> <ul style="list-style-type: none"> ▶  Indicates the direction of the physical relationship. ▶  Indicates the direction opposite to the physical relationship. |
| Source | The required source node. |
| Target | The required target node. |

Icon Page

| | |
|------------------------------|--|
| Description | <p>Enables you to select an icon to assign to the new CI Type.</p> <p>Note: This step of the wizard is not relevant for relationships.</p> |
| Important Information | <p>Each CIT is displayed with a default icon. However, you can attach different icons to the same CIT when certain conditions apply. For example, you can associate different icons with the same CIT when one of its attribute values changes.</p> |
| Wizard Map | <p>The Create Configuration Item Type/Relationship/Calculated Relationship Wizard contains:</p> <p>Details Page > Attributes Page > Qualifiers Page > Triplets Page > Icon Page > Attached Menu Page > Default Label Page</p> |





The following elements are included (unlabeled GUI elements are shown in angle brackets>):

| GUI Element (A-Z) | Description |
|---|--|
|  | Click to add a row. Note: Only active if Change the Configuration Item Type icon according to its attribute value is selected. |
|  | Click to remove a row. Note: Only active if Change the Configuration Item Type icon according to its attribute value is selected. |
| Attribute Name | Select an attribute to determine the icon assigned to the CIT. |
| Change the Configuration Item Type icon according to its attribute value | Enables you to assign an icon for each attribute value. For example, you could define two values for the City attribute: if City=London, one icon is displayed. If City=Beijing, another icon is displayed. Note: If you change the icon of a CIT that appears in an existing view, the CIT's icon is not updated in the view. |
| Configuration Item Type Main Icon | Select the group to which the CIT belongs. |
| Icon | Select an icon to associate with the value you entered in the Value column. |
| Value | Enter a value corresponding to the attribute you selected. You can add a new line for each value you enter. |

Attached Menu Page

| | |
|------------------------------|---|
| Description | Enables you to customize the shortcut menu of a CI by adding menu items and commands (for example, ping, run a program, open a URL). The customized menu is displayed when you right-click a CI instance in IT Universe Manager. |
| Important Information | If a CIT does not have a method defined specifically for it, the CIT inherits all the menus from its parent CIT or the nearest ancestor that does have a method defined for it. If you create or modify a menu, the change occurs only in the specific CIT that is being edited. |
| Wizard Map | The Create Configuration Item Type/Relationship/Calculated Relationship Wizard contains: Details Page > Attributes Page > Qualifiers Page > Triplets Page > Icon Page > Attached Menu Page > Default Label Page |

The following elements are included (unlabeled GUI elements are shown in angle brackets):

| GUI Element (A-Z) | Description |
|---|--|
|  | Select a menu item from the tree and click the button. A new entry appears under the selected item. |
|  | Click to remove a menu item. |
|  | Click to move a selected menu item up in the menu. |
|  | Click to move a selected menu item down in the menu. |
| <Tree> | Hierarchical tree containing the default menu items. Caution: It is not recommended to edit the definitions of the default menu items. |

| GUI Element (A-Z) | Description |
|------------------------|---|
| Command | <p>To connect to a specific location on the World Wide Web, select URL, and enter the exact Internet address, for example, <code>http://www.hp.com/go/software</code>. (Available only if you select the URL command type option.)</p> <p>Note: If you use a variable in the Command field, use the format <code>command name %1</code> and define the CIT attributes as described in Parameters. The parameter values replace %1 according to their order in the list. For example, %1 is replaced by the first parameter in the list, %2 is replaced by the second parameter in the list, and so on.</p> |
| Description | Enter a description for the method. (This is for internal use only and does not appear in the menu.) |
| Existing Method | Select to choose a command from a list of defined methods inherited from the IT Universe CIT and all its ancestors. |
| Icon | <p>Select the icon to appear next to the menu option in the context menu.</p> <p>Note: This field is optional.</p> |
| Menu Item Name | Enter a name for the new menu item as it should appear in the menu. |
| Method | <p>Enables you to add a command to the menu.</p> <p>Note: To create a method and not override the existing method, it is recommended to create a new menu item and place the new method there.</p> |
| Method Name | Enter a name for the command. |
| New Method | Select to add an action (for example, ping) to the menu item. |
| Parameters | <p>To add attributes to the command or URL, click the Add Parameter button and select the attribute from the list.</p> <p>To delete an existing entry, select it and click the Remove Parameter button.</p> <p>Note: Parameters are not relevant when Inner Process is selected.</p> |

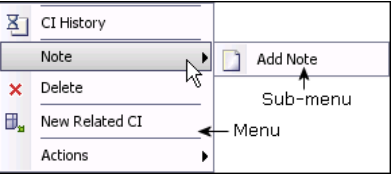
| GUI Element (A-Z) | Description |
|-----------------------------------|---|
| Require user confirmation? | Select the check box for users to confirm access to a menu item before the item is displayed. |
| Separator | To place a separator between two menu items: Click OK to place a separator underneath the selected menu option. |
| Shortcut | Press any key combination to create a shortcut for the menu item, for example, CTRL+H. Note: This field is optional. |
| Sub-Menu | Select to create a sub-menu under the selected menu option.  |
| Type | Choose a command type: <ul style="list-style-type: none"> ▶ URL. Opens a web page to the specified URL. Enter the URL of a Web page for the command to open in the URL box. ▶ Inner Process. Triggers an internal HP Universal CMDB action. Select an action from the drop-down list of actions. ▶ Execute. Triggers an executable action. Enter an executable command in the Executable box. |

Default Label Page

| | |
|------------------------------|---|
| Description | <p>Enables you to define attributes that appear in the CIT label. You can include more than one attribute by using the function buttons.</p> <p>The final step of the Create Configuration Item Type Wizard.</p> |
| Important Information | <p>The label appears as the title under a CI of the new CI Type. The label definition can be customized to include different attribute values. For example, if the function label of the host CIT is composed of <code>hostname</code> and <code>network</code>, the displayed label is: <code>server1 10.0.65.0</code>.</p> <p>Labels can also be created using regular expressions.</p> |
| Wizard Map | <p>The Create Configuration Item Type/Relationship/Calculated Relationship Wizard contains:</p> <p>Details Page > Attributes Page > Qualifiers Page > Triplets Page > Icon Page > Attached Menu Page > Default Label Page</p> |

The following elements are included (unlabeled GUI elements are shown in angle brackets>):

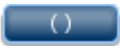
| GUI Element (A-Z) | Description |
|---|---|
|  | Selects the attributes to appear in the Format box. Use the following function buttons to display multiple attributes in the label. |
|  | Adds parentheses to the formatted text (use in conjunction with the other functions). |
| And | Places an AND operator between two attributes in the formatted text. For example, <code>network_netaddr&network_domain</code> displays the network address and the domain of a node. |
| Attribute Name | Displays the available options of attributes to be included in the CIT label. |
| Clear | Click to clear the Format window. |

| GUI Element (A-Z) | Description |
|-------------------|---|
| Format | <p>Displays the attributes that you select to appear in the CIT label.</p> <p>For example, to label a host by its host name and operating system, choose the host_hostname and host_os attributes. The CIT label is host1 UNIX.</p> <p>You can define conditions using AND and OR combinations.</p> <p>Note: To delete an attribute from the Format box, highlight it and press the DELETE key.</p> |
| Or | <p>Places an OR operator between two attributes in the formatted text.</p> |
| RegExp | <p>Adds a regular expression (using regular expression syntax) to the label definition. The structure of the entry is (v1, v2, v3), where v1 represents the selected attribute, v2 represents the regular expression itself (which divides the value into groups), and v3 represents the number of the selected group.</p> <p>For example, if the selected attribute is a name, consisting of a first name, a space, and a surname, the regular expression would be (name, (\S*)(\s*)(\S*), 3), which indicates that the surname can be used for the name attribute in the default label.</p> <p>For examples of how to use regular expression syntax, see “Regular Expression Examples” in <i>Reference Information</i>.</p> |
| Undo | <p>Click to undo the last change in the Format window.</p> |

Create/Update List/Enumeration Definition Dialog Box

| | |
|------------------------------|---|
| Description | Enables you to define a new List or Enumeration definition. The List or Enumeration definition you have created appears in the System Type Manager dialog box, where you can edit it if required (for details, see “System Type Manager Dialog Box” on page 243). To access: Click the Add button in the System Type Manager dialog box. |
| Important Information | You can access the Create/Update Enumeration Definition dialog box from the State Manager as well. For details, see “State Manager” on page 499. |
| Included in Tasks | “Create List and Enumeration Definitions” on page 213 |



The following elements are included (unlabeled GUI elements are shown in angle brackets>):

| GUI Element (A-Z) | Description |
|--------------------------|--|
| Display Name | Enter the name you want to appear in the list of System Type Definitions. If you leave this field empty, the entry in the Name field is used. |
| Enumeration | Enables you to create a predefined list of values, as well as assign each value a color. For details, see “Enumeration Definition Area” on page 242. |
| List | Enables you to create a predefined list of values. For details, see “List Definition Area” on page 241. |
| Name | Enter a unique name for the definition. |

List Definition Area

| | |
|--------------------|--|
| Description | <p>Create a predefined list of values. For example, a Location attribute might be defined by a location list containing the following values:</p> <ul style="list-style-type: none"> ▶ New York ▶ Boston ▶ Baltimore <p>To access: Select List in the Create List/Enumeration Definition dialog box.</p> |
|--------------------|--|



The following elements are included (unlabeled GUI elements are shown in angle brackets>):

| GUI Element (A-Z) | Description |
|---|---|
|  | Add a List definition. Double-click inside the row and either select a date from the calendar that appears (if you chose the type Date) or type the required value. |
|  | Delete a List definition. |
| Type | Choose one of following field types: <ul style="list-style-type: none"> ▶ Date ▶ Double ▶ Integer ▶ Long ▶ String |

Enumeration Definition Area

| | |
|---------------------|--|
| Description | <p>Enables you to create a list from a predefined list of values (similar to List), with capabilities such as assigning a color for every value. Enumerations are designed to be used as severity value lists by states. You can use Enumerations for lists that require key values.</p> <p>To access: Select Enumeration in the Create List/Enumeration Definition dialog box.</p> |
| Useful Links | “Enumeration Definition – Workflow” on page 214 |



The following elements are included (unlabeled GUI elements are shown in angle brackets>):

| GUI Element (A-Z) | Description |
|---|--|
|  | Add an Enumeration definition. |
|  | Remove an Enumeration definition. |
| Color | Select a color that indicates the severity level. |
| Key | <p>Type a number to create an enumeration that describes a severity list for a category.</p> <p>Assign key values according to the following rules:</p> <ul style="list-style-type: none"> ▶ The list of key values must always begin with zero (0). (Zero represents the Normal state.) Otherwise, it does not appear in the State Manager (for details, see “State Manager” on page 499). ▶ The list must always be numbered consecutively. <p>For an example of an Enumeration definition, see “Enumeration Definition – Workflow” on page 214.</p> |
| Value | Type a value, either a string or a number, for example, Red or my value. The value appears in the tooltip for the CI in IT Universe Manager. |

System Type Manager Dialog Box

| | |
|--------------------------|---|
| Description | Displays the attribute types you defined in the Create List/Enumeration Definition dialog box. To access: Select CI Types > System Type Manager . |
| Included in Tasks | “Create List and Enumeration Definitions” on page 213 |
| Useful Links | “Enumeration Definition – Workflow” on page 214 |

The following elements are included (unlabeled GUI elements are shown in angle brackets>):

| GUI Element (A-Z) | Description |
|---|--|
|  | Create a predefined list whose values define an attribute type. You can create a definition for the following attribute types: <ul style="list-style-type: none"> ▶ List definition. ▶ Enumeration definition. For a description of these attribute types, see “Create/Update List/Enumeration Definition Dialog Box” on page 240. |
|  | Delete an existing definition. Select the system type definition you want to delete and click the Delete button. |
|  | Enables you to edit an existing definition. For details, see “Create/Update List/Enumeration Definition Dialog Box” on page 240. |
| <System Type Definitions> | The list of Enumeration and List definitions created in the System Type Manager. |

7

Topology Report Manager

This chapter provides information on Topology Report Manager.

This chapter includes:

Concepts

- ▶ Topology Report Manager Overview on page 246

Tasks

- ▶ Define a Report Rule – Scenario on page 246
- ▶ Compare a CI Configuration to a Gold Master Template on page 256

Reference

- ▶ Topology Report Manager User Interface on page 256

Troubleshooting and Limitations on page 282

Topology Report Manager Overview

Topology Report Manager enables you to define the following reports:

- ▶ **Topology reports.** Contains information about selected Report nodes in the managed world. Each report is based on a specific Report TQL query, which is created especially for it. (If required, you can define multiple reports for each query.) For more information about TQL queries, see “Topology Query Language” on page 323. Topology Report Manager enables you to define exactly which information appears in each report, including the order in which nodes are listed and their placement relative to other nodes, and how the information within each report is sorted. For details, see “Topology Report Manager Window” on page 267.
- ▶ **Gold Master reports.** Compares the configuration of a Gold Master CI to other CIs of the same CI type. Select the CI you want to use as the Gold Master CI, and then the CIs whose configuration you want to compare to the Gold Master template. You can choose the CIs from existing views or from the CMDB. The report that is generated specifies which of the selected CIs are configured differently. For details, see “Gold Master Report Pane” on page 261.

Define a Report Rule – Scenario

This scenario describes how to create a Report TQL definition whose query results retrieve hosts that run on a Windows operating system. By changing a report’s parameterized values, you can generate a report from that same TQL query displaying hosts that run on a Linux operating system.

Note: To retrieve the required query results, you must follow each step in this scenario.

This task includes the following steps:

- “Create a Report TQL Query” on page 247
- “Set TQL Node Definitions” on page 248
- “Define the Column Content of the Selected Node” on page 249
- “Sort the Column Information” on page 250
- “Set the Node Order” on page 251
- “Refine the Report Layout” on page 252
- “View a Topology Report Displaying Hosts that Run on a Windows Operating System” on page 254
- “View a Topology Report Displaying Hosts that Run on a Linux Operating System” on page 255

1 Create a Report TQL Query

To create a Report TQL query, you need to define a Report rule and then add the TQL nodes and relationships that define the query.

Select **Admin > Modeling > Topology Report Manager** to open Topology Report Manager. For details about how to create a Report TQL query, see “New Report/Report Properties/Save As Report Wizard” on page 263. For details about how to add nodes and relationships to a query, see “Add Nodes and Relationships to a TQL Query”.

Example of a Report TQL Query

In this Report TQL query, a Network and a Host node are linked by a Member relationship and the Host node is linked to an IP node by a Contained relationship. The TQL results must comply with the direction of the arrows.

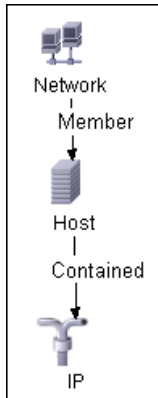

Note: A TQL query is subject to certain validation restrictions. For details, see “Troubleshooting and Limitations” on page 401.

2 Set TQL Node Definitions

You can set attribute definitions for the nodes and relationships you added to the TQL query. In the editing pane, right-click the required node, and select **Node Properties** to open the Node Properties dialog box. Then click the Attribute tab. For details on how to define node and relationship definitions, see “Node/Relationship Properties Dialog Box” on page 375.

Example of a TQL Node Definition

In Topology Report Manager, the attribute condition of the Host node are defined in the Attribute tab in the Node Properties dialog box to retrieve only hosts that run on a Windows operating system.

To do this, in the Attribute tab, select the following:

- ▶ **Attribute name** — Host Operating System
- ▶ **Operator** — Like ignore case
- ▶ **Parameterized Value**
- ▶ **Value** — %windows%

When the **Parameterized Value** equals %windows%, all hosts that run on a Windows operating system are displayed in the query results.

3 Define the Column Content of the Selected Node

Define which nodes to include in the report, and which attributes and functions to display for each node. In the editing pane, right-click the required node, and select **Report Node Definition** to open the Report Node Definition dialog box. Click the **Add Attributes** button to select the required attributes. For details, see “Report Node Definition Dialog Box” on page 276.

Example of Nodes to Be Included in a Report

- ▶ The attributes **Network Address** and **Network Class** are selected for the Network node.

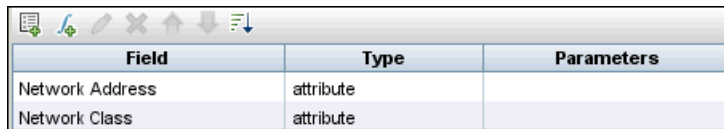

| Field | Type | Parameters |
|-----------------|-----------|------------|
| Network Address | attribute | |
| Network Class | attribute | |

- ▶ The attributes **Host DNS Name** and **Host Operating System** are selected for the Host node.

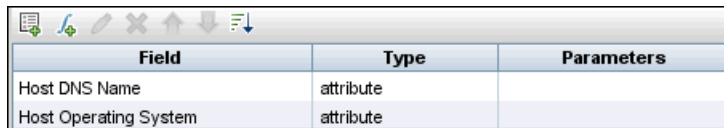

| Field | Type | Parameters |
|-----------------------|-----------|------------|
| Host DNS Name | attribute | |
| Host Operating System | attribute | |

- The attributes **IP Network Address**, **IP Network Mask**, and **Last Access Time** are selected for the IP node.

| Field | Type | Parameters |
|--------------------|-----------|------------|
| IP Network Address | attribute | |
| IP Network Mask | attribute | |
| Last Access Time | attribute | |

4 Sort the Column Information

Determine the order of the information displayed for each node, and the method by which the data is sorted in each column. In the editing pane, right-click the appropriate node and select **Report Node Definition** to open the Report Node Definition dialog box. Then click **Sort** to open the Attribute Column dialog box to define the order in which the node's attributes appear in the Topology report. For details, see "Attribute Columns Dialog Box" on page 259.

Example of the Order in Which the Node Information is Displayed in a Report

In the Attribute Columns dialog box, the attributes for the Network node are defined to appear in the Topology report in the following order:

Sort Items by

Network Class Ascending Descending

Then by

Network Address Ascending Descending

In the Attribute Columns dialog box, the attributes for the Host node are defined to appear in the Topology report in the following order:

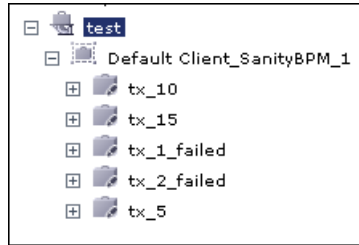

In the Attribute Columns dialog box, the attributes for the IP node are defined to appear in the Topology report in the following order:



5 Set the Node Order

Determine the order of the nodes in the report. Right-click any node from the query and select **Node Order** to open the Set Node Order dialog box. The Set Node Order dialog box displays a row for each node that is included in the report. Use the up and down arrows to move the nodes to the required location in the report. For details, see “Set Node Order Dialog Box” on page 279.

Example of How the Order of the Nodes is Displayed in a Report

Use the up and down arrows to move the **Network** node to the beginning of the list and the **IP** node to the bottom. The **Network** node is the parent node, so it should appear at the beginning of the report. The data of the **Host** node is displayed next, followed by the **IP** node.



| Nodes |
|---------|
| Network |
| Host |
| IP |

6 Refine the Report Layout

You can display nodes dependent on other nodes either aligned underneath or indented underneath the parent node a generated report. Displaying nodes indented beneath one another enables you to better distinguish between parent nodes and their children.

The editing pane enables you to define how nodes are displayed in a generated report in relation to one another. For details about the editing pane, see “Topology Report Manager Window” on page 267.

Example of How Nodes are Displayed in Relation to One Another

- In this report, the **IP** CI is defined as the child of the **Host** CI, and the **Host** CI is defined as the child of the **Network** CI. As a result, the **IP** CI is indented underneath the **Host** CI and the **Host** CI is indented under the **Network** CI in the generated report.

| | |
|--|--|
| [-] 192.168.59.0 (Network) | |
| Network Address: 192.168.59.0 Network Class: C | |
| [-] labm2am141 (Host) (Path: 192.168.59.0 (Network)) | |
| Host DNS Name: devlab.ad Host Operating System: Windows 2003 | |
| [-] 192.168.140.1 (IP) (Path: 192.168.59.0 (Network) --> labm2am141 (Host)) | |
| IP Network Address: 192.168.140.0 Last Access Time: Sat Feb 9, 2008 06:29 AM | |
| IP Network Mask: 255.255.255.0 | |
| [-] 192.168.59.1 (IP) (Path: 192.168.59.0 (Network) --> labm2am141 (Host)) | |
| IP Network Address: 192.168.59.0 Last Access Time: Sat Feb 9, 2008 06:29 AM | |
| IP Network Mask: 255.255.255.0 | |
| [-] 16.59.57.130 (IP) (Path: 192.168.59.0 (Network) --> labm2am141 (Host)) | |

- In this report, the **IP**, **Host**, and **Network** CIs are defined as siblings, so all the CIs are displayed aligned with one another.

| |
|--|
| [-] 192.168.59.0 (Network) |
| Network Address: 192.168.59.0 Network Class: C |
| [-] labm2am141 (Host) |
| Host DNS Name: devlab.ad Host Operating System: Windows 2003 |
| [-] 192.168.140.1 (IP) |
| IP Network Address: 192.168.140.0 Last Access Time: Sat Feb 9, 2008 06:29 AM |
| IP Network Mask: 255.255.255.0 |

7 View a Topology Report Displaying Hosts that Run on a Windows Operating System

In the Reports pane, right-click the Report TQL query definition and select **Generate**.

| | |
|--|--|
| [-] 192.168.59.0 (Network) | |
| Network Address: 192.168.59.0 Network Class: C | |
| [-] labm2am141 (Host) (Path: 192.168.59.0 (Network)) | |
| Host DNS Name: devlab.ad | Host Operating System: Windows 2003 |
| [-] 192.168.140.1 (IP) (Path: 192.168.59.0 (Network) --> labm2am141 (Host)) | |
| IP Network Address: 192.168.140.0 | Last Access Time: Sat Feb 9, 2008 06:29 AM |
| IP Network Mask: 255.255.255.0 | |
| [-] 192.168.59.1 (IP) (Path: 192.168.59.0 (Network) --> labm2am141 (Host)) | |
| IP Network Address: 192.168.59.0 | Last Access Time: Sat Feb 9, 2008 06:29 AM |
| IP Network Mask: 255.255.255.0 | |
| [-] 16.59.57.130 (IP) (Path: 192.168.59.0 (Network) --> labm2am141 (Host)) | |
| IP Network Address: 16.59.57.0 | Last Access Time: Sun Feb 10, 2008 04:22 AM |
| IP Network Mask: 255.255.255.0 | |
| [-] 192.168.214.0 (Network) | |
| Network Address: 192.168.214.0 Network Class: C | |
| [-] labm2am22 (Host) (Path: 192.168.214.0 (Network)) | |

This report displays an instance of a host CI that runs on a Windows 2003 operating system.

8 View a Topology Report Displaying Hosts that Run on a Linux Operating System

In the Reports pane, right-click the Report TQL query and select **Set Report Parameters** to open the **Set Report Parameters** wizard. Click **%windows%**, and in the Editing window that opens, enter **%linux%**. Save the new definition. Then right-click the **Hosts** report definition and select **Generate**.

| | |
|--|--|
| 16.59.57.0 (Network) | |
| Network Address: 16.59.57.0 | Network Class: C |
| beatboxqa2 (Host) (Path: 16.59.57.0 (Network)) | |
| Host DNS Name: | Host Operating System: Linux |
| 16.59.57.207 (IP) (Path: 16.59.57.0 (Network) --> beatboxqa2 (Host)) | |
| IP Network Address: 16.59.57.0 | Last Access Time: Sun Feb 10, 2008 04:22 AM |
| IP Network Mask: 255.255.255.0 | |
| LABM2PCOE26 (Host) (Path: 16.59.57.0 (Network)) | |
| Host DNS Name: | Host Operating System: Linux |
| 16.59.57.122 (IP) (Path: 16.59.57.0 (Network) --> LABM2PCOE26 (Host)) | |
| IP Network Address: 16.59.57.0 | Last Access Time: Sun Feb 10, 2008 04:22 AM |
| IP Network Mask: 255.255.255.0 | |
| labm2am154 (Host) (Path: 16.59.57.0 (Network)) | |
| Host DNS Name: | Host Operating System: Linux |
| 16.59.57.212 (IP) (Path: 16.59.57.0 (Network) --> labm2am154 (Host)) | |
| IP Network Address: 16.59.57.0 | Last Access Time: Sun Feb 10, 2008 04:22 AM |

This report displays an instance of a host CI that runs on a Linux operating system.

Compare a CI Configuration to a Gold Master Template

This task describes how to create a Gold Master report definition and then generate a Gold Master report.

This task includes the following steps:

- “Create a Gold Master Report Definition” on page 256
- “Generate a Gold Master Report” on page 256

1 Create a Gold Master Report Definition

Define a Gold Master report that compares the configuration of a Gold Master CI to other CIs of the same CI type, or a child of the CI type. Select the CI you want to use as the Gold Master CI and then the CIs whose configuration you want to compare to the Gold Master template. You can select the CIs from existing views or from the CMDB. For details, see “Gold Master Report Pane” on page 261.

2 Generate a Gold Master Report

Generate a report that specifies which of the selected CIs are configured differently. For details, see “Gold Master Report Pane” on page 261.

Topology Report Manager User Interface

This section describes:

- Add Attributes Dialog Box on page 257
- Add/Edit Function Dialog Box on page 258
- Attribute Columns Dialog Box on page 259
- Edit Attribute Dialog Box on page 260
- Filter CITs Dialog Box on page 260
- Gold Master Report Pane on page 261
- New Report/Report Properties/Save As Report Wizard on page 263

- Topology Report Manager Window on page 267
- Report Node Definition Dialog Box on page 276
- Set Node Order Dialog Box on page 279
- Set Report Parameters Wizard on page 280
- Set View-specific Report Dialog Box on page 281

Add Attributes Dialog Box

| | |
|------------------------------|--|
| Description | Enables you to define the content of the selected Report node's columns. To access: Click the Add Attributes  button in the Report Node Definition dialog box. |
| Included in Tasks | "Define a Report Rule – Scenario" on page 246 |
| Important Information | Attributes that have already been selected in the Report Node Definition dialog box do not appear on the list. |

The following elements are included (unlabeled GUI elements are shown in angle brackets):

| GUI Element (A-Z) | Description |
|-------------------------------|---|
| <Click a column header> | For details, see "Customizing Columns" in <i>Reference Information</i> . |
| <Right-click a column header> | For details, see "Customizing Columns" in <i>Reference Information</i> . |
| Add | Select the check box of the attributes you want to appear in the report. The selected attributes appear in the Report Node Definition dialog box. Each attribute you add represents a column in the report. |
| Attribute | The name of the attribute. |
| Column Title | The column title, by default, takes the same name as the selected attribute. You can change the title of the column in the Edit Attribute dialog box. |

Add/Edit Function Dialog Box

| | |
|--------------------------|--|
| Description | Enables you to define which of the node's functions and parameters you want to include in the report. To access: Click the Add Function  button in the Report Node Definition dialog box. |
| Included in Tasks | "Define a Report Rule – Scenario" on page 246 |

The following elements are included (unlabeled GUI elements are shown in angle brackets>):

| GUI Element (A-Z) | Description |
|-------------------|--|
| Attribute | Define the necessary parameters. |
| Function | From the Function list, select the function you want to use to calculate the results on these columns. Following are the available options: <ul style="list-style-type: none"> ▶ average. The average value of all the attributes of the connected nodes. ▶ count. Calculate the number of node instances connected to the selected node. ▶ max. The maximum value of all the attributes of the connected nodes. ▶ min. The minimum value of all the attributes of the connected nodes. ▶ sum. The sum of all the attributes of the connected nodes. |
| Related | The node on which you want to perform the function. |
| Title | The name of the function attribute displayed in the report. |

Attribute Columns Dialog Box

| | |
|--------------------------|---|
| Description | Determine the order of the information displayed for each Report node, and the method by which the data is sorted in each column. To access: Click the Sort  button in the Report Node Definition dialog box. |
| Included in Tasks | “Define a Report Rule – Scenario” on page 246 |

The following elements are included (unlabeled GUI elements are shown in angle brackets>):

| GUI Element (A-Z) | Description |
|----------------------|--|
| Ascending | Sort the information in ascending order. |
| Descending | Sort the information in descending order. |
| Sort Items by | Select the primary sort column from the Sort Item by list. |
| Then by | Define up to three secondary sort columns from the Then by lists. |

Edit Attribute Dialog Box

| | |
|--------------------------|--|
| Description | Modify the name of the column title. To access: Select the required attribute in the Report Node Definition dialog box and click the Edit/Attribute Function  button. |
| Included in Tasks | “Define a Report Rule – Scenario” on page 246 |

The following elements are included (unlabeled GUI elements are shown in angle brackets>):

| GUI Element (A-Z) | Description |
|---------------------|--|
| Attribute | Displays the node’s selected attribute. This box cannot be edited. |
| Column Title | Modify the column title as required. The name that appears in the Column Title box is, by default, the same name as the attribute. The modified column title appears in the Field column in the Report Node Definition dialog box. |

Filter CITs Dialog Box

| | |
|--------------------|--|
| Description | Enables you to exclude the CI types you do not want to appear in the Gold Master report. To access: Click the Filter CI Types  button in the Gold Master Report pane. |
|--------------------|--|



The following elements are included (unlabeled GUI elements are shown in angle brackets>):

| GUI Element (A-Z) | Description |
|--------------------|---|
| <List of CI types> | The CI types you select are excluded from the report. |

Gold Master Report Pane

| | |
|-------------------------------------|---|
| <p>Description</p> | <p>Define a Gold Master report definition that compares the configuration of a Gold Master CI to other CIs of the same CI type or a child of the CI type. You choose the CI you want to use as the Gold Master CI and then the CIs whose configuration you want to compare to the Gold Master template. You can choose the CIs from existing views or from the CMDB. The report that is generated specifies which of the selected CIs are configured differently.</p> <p>To access:</p> <ol style="list-style-type: none"> 1 Select Admin > Modeling > Topology Report Manager. 2 Right-click anywhere in the Reports pane and click New or click the New  button to open the New Report Wizard. 3 Define the report and select Gold Master. |
| <p>Important Information</p> | <ul style="list-style-type: none"> ▶ You can also define a schedule that generates and saves Gold Master reports on a periodic basis. For details, see “Scheduler” on page 485. ▶ The CIs appear in this report under the following circumstances: <ul style="list-style-type: none"> ▶ Their attributes are marked as Comparable in the Add Attribute dialog box in the CI Type Manager. ▶ The CIs have descendants that are defined as Comparable. <p>For details, see “Add/Edit Attribute Dialog Box” on page 217.</p> |

The following elements are included (unlabeled GUI elements are shown in angle brackets>):

| GUI Element (A-Z) | Description |
|---|---|
|  | <p>Determines which CI types are not included in the Gold Master report. Opens the Filter CIs dialog box.</p> |
|  | <p>Generates a Gold Master report. For details, see “Gold Master Report” on page 551.</p> |

| GUI Element (A-Z) | Description |
|---|---|
|  | Moves the required CIs back and forth between the left pane and the Master CIs pane and the Compared CIs panes. |
| Include Similar Items | Select this check box if you want to include the compared CIs whose configuration is identical to that of the Gold Master CI. |

Compared CIs Pane

| | |
|------------------------------|--|
| Description | Contains the CIs that you want to compare to the Gold Master CI. |
| Important Information | You can select multiple CIs. |

Master CI Pane

| | |
|--------------------|--|
| Description | Contains the CI you want to use as a Gold Master CI. |
|--------------------|--|

Left Pane

| | |
|--------------------|--|
| Description | <p>The left pane contains the following tabs:</p> <ul style="list-style-type: none"> ▶ Browse. Select the required CI from different levels of the view hierarchy. For details, see “Browse Tab” on page 574. ▶ Search. Search for a specific CI in existing views or in the entire CMDB. For details, see “Search Tab” on page 574. |
|--------------------|--|

New Report/Report Properties/Save As Report Wizard

| | |
|--------------------------|---|
| Description | <p>Create or modify a Topology or Gold Master report definition.</p> <p>To access:</p> <ul style="list-style-type: none"> ▶ To create a Topology or Gold Master report definition, right-click anywhere in the Reports pane and click New or click the New  button. ▶ To modify a Topology or Gold Master report definition, right-click a report definition in the Reports pane and select Properties. ▶ To create a new report based on an existing query, right-click a report definition in the Reports pane and select Save As. |
| Included in Tasks | “Define a Report Rule – Scenario” on page 246 |
| Wizard Map | <p>The New Report/Report Properties/Save As Report Wizard contains:</p> <p>Report General Attributes Page > Report Titles Page > Report Base TQL Page > Report Completion Page</p> |

Report General Attributes Page

| | |
|------------------------------|--|
| Description | Enables you to enter a unique name and description for a Topology or Gold Master report. |
| Included in Tasks | “Define a Report Rule – Scenario” on page 246 |
| Important Information | By default, this wizard is set to display a Welcome page. You can choose not to display the Welcome page by changing the user preferences. For details, see “User Preferences Dialog Box” on page 400. |
| Useful Links | “Topology Query Language” on page 323 |
| Wizard Map | <p>The New Report/Report Properties/Save As Report Wizard contains:</p> <p>Report General Attributes Page > Report Titles Page > Report Base TQL Page > Report Completion Page</p> |

The following elements are included (unlabeled GUI elements are shown in angle brackets>):

| GUI Element (A-Z) | Description |
|---------------------------|---|
| Report Description | (Optional) Enter a description of the report. |
| Report Name | <p>Enter a unique name for the Topology or Gold Master report.</p> <p>The report name cannot contain any of the following characters: \ / : " < > % ?</p> <p>Note: If the Report name is either empty, contains a name used by another report, or uses invalid characters, the Next and Finish buttons are disabled.</p> |
| Report Type | <p>Select one of the following options:</p> <ul style="list-style-type: none"> ▶ Gold Master. Create a Gold Master report. For details on how to define a Gold Master report, see “Gold Master Report Pane” on page 261. ▶ Topology. Create a Topology report. For details, see “Topology Report” on page 591. |

Report Titles Page

| | |
|------------------------------|--|
| Description | Enables you to define the report titles. |
| Included in Tasks | “Define a Report Rule – Scenario” on page 246 |
| Important Information | This page is relevant to Topology reports only. |
| Useful Links | “Topology Query Language” on page 323 |
| Wizard Map | <p>The New Report/Report Properties/Save As Report Wizard contains:</p> <p>Report General Attributes Page > Report Titles Page > Report Base TQL Page > Report Completion Page</p> |

The following elements are included (unlabeled GUI elements are shown in angle brackets>):

| GUI Element (A-Z) | Description |
|------------------------|---|
| Report Subtitle | Enter the subtitle of the Topology report. This title appears underneath the title at the head of the report. |
| Report Title | Enter the title of the Topology report. This title appears at the head of the report. |

Report Base TQL Page

| | |
|------------------------------|---|
| Description | Enables you to define the properties of the TQL on which the Topology report is based. |
| Included in Tasks | “Define a Report Rule – Scenario” on page 246 |
| Important Information | <ul style="list-style-type: none"> ▶ This page is relevant to Topology reports only. ▶ By default, this wizard is set to display a Completion page after clicking Next in this page. You can choose not to display the Completion page by changing the user preferences. For details, see “User Preferences Dialog Box” on page 400. |
| Useful Links | “Topology Query Language” on page 323 |
| Wizard Map | <p>The New Report/Report Properties/Save As Report Wizard contains:</p> <p>Report General Attributes Page > Report Titles Page > Report Base TQL Page > Report Completion Page</p> |

The following elements are included (unlabeled GUI elements are shown in angle brackets>):

| GUI Element (A-Z) | Description |
|---|--|
| Base the report on a new TQL | Select this check box if you want to base the Topology report on a new TQL query. The report that is generated displays the results of the attributes defined for the new TQL. |
| Base the report on an existing TQL | Select this check box if you want to base the Topology report on an existing TQL query. Select the required Report TQL query from the drop-down list. |
| Base TQL Description | (Optional) Enter a description of the TQL query. |
| Base TQL Name | Enter a unique name for the Report TQL query. If you selected the Base the report on an existing TQL option, select the Report TQL query on which you want to base the Topology report. |
| Base TQL Priority | Select a priority level for the new TQL query (Low, Medium, High, Express). This setting determines how often the query is rerun automatically by the system to include updated information from the CMDB. |

Report Completion Page

| | |
|------------------------------|--|
| Description | Enables you to complete the definition of the report. |
| Included in Tasks | “Define a Report Rule – Scenario” on page 246 |
| Important Information | This page is relevant to Topology reports only. |
| Useful Links | “Topology Query Language” on page 323 |
| Wizard Map | The New Report/Report Properties/Save As Report Wizard contains: Report General Attributes Page > Report Titles Page > Report Base TQL Page > Report Completion Page |











Topology Report Manager Window

| | |
|------------------------------|---|
| Description | <p>Topology Report Manager enables you to:</p> <ul style="list-style-type: none"> ▶ Define Topology reports about specific Report nodes. Each report is based on a specific Report TQL query, which is created especially for it. You can define exactly what information appears in each report, including the order in which Report nodes are listed and their placement relative to other Report nodes, and how the information within each report is sorted. ▶ Define a report that compares the configuration of a Gold Master CI to other CIs of the same CI type or a child of the CI type. For details, see “Gold Master Report Pane” on page 261. <p>To access: Select Admin > Modeling > Topology Report Manager.</p> |
| Important Information | <p>You can also define a schedule that creates Topology reports based on a specific Report query, on a periodic basis. For details, see “Scheduler” on page 485.</p> |
| Included in Tasks | <ul style="list-style-type: none"> ▶ “Define a Report Rule – Scenario” on page 246 ▶ “Compare a CI Configuration to a Gold Master Template” on page 256 |

Reports Pane

| | |
|--------------------|---|
| Description | <p>Displays a hierarchical tree structure of predefined folders containing report definitions. Each report is associated with a TQL query.</p> <p>You can create your own TQL query, or work with the default queries provided with your HP Universal CMDB installation.</p> <p>The predefined folders are provided for the default queries. You can modify these folders, or add additional folders according to your organization’s requirements.</p> |
|--------------------|---|

The following elements are included (unlabeled GUI elements are shown in angle brackets>):

| GUI Element (A-Z) | Description |
|---|---|
|  | Create a new folder. |
|  | Create a TQL Report or Gold Master report definition. Opens the New Report wizard. |
|  | Delete the selected folder or report. |
|  | Refresh the data content of the hierarchical tree structure that may have been modified by other users. |
|  | (Enabled only when a report is created or when changes are made to an existing one.) Save the Gold Master or Topology report to the CMDB. |
|  | Open the New Report Properties wizard. Enables you to change the description and activation state of the report. |
|  | Generates a preview of the results of the selected Report TQL. |
|  | Represents a folder. |
|  | Represents a Gold Master report definition. |
|  | Represents a Topology report definition. |

The following elements are available by right-clicking a folder or report:

| GUI Element (A-Z) | Description |
|----------------------|--|
| Delete | Delete the selected folder or report definition from the CMDB. |
| Export | Displays a standard Save As dialog box, enabling you to save the report as an XML script. This option can be used to move a report from one workstation to another, provided the related TQL Report query is also relocated. Note: Only relevant for Topology reports and not Gold Master reports. |
| Import | Import XML files that contain saved Report queries to Topology Report Manager. |
| New | Create a TQL Report or Gold Master report definition. Opens the New Report Wizard. |
| New Folder | Create a new folder. |
| Properties | Open the Report Properties wizard. Enables you to change the description and activation state of the report. |
| Rename Folder | Rename the folder. |
| Preview | Generates a preview of the results of the selected Report TQL. |
| Save | (Enabled only when a new TQL Report or Gold Master report definition is created or when changes are made to an existing one.) Save the TQL Report or Gold Master report definition to the CMDB. |
| Save As | Displays the Save As dialog box, enabling you to define a new name and description for a TQL Report or Gold Master report definition. This option can be used for creating a new report based on an existing one. |

| GUI Element (A-Z) | Description |
|---------------------------------|---|
| Set Report Parameters | <p>Enables you to generate a report using values different than the ones you defined in the Attribute tab in the Node/Relationship dialog box. Opens the Set Report Parameters wizard.</p> <p>Note: This option only appears if you defined a parameterized value in the Attribute tab in the Node/Relationship Properties dialog box.</p> |
| Set View-specific report | <p>(Optional) Enables you to generate a report of the selected Report TQL query based on a certain view rather than the entire CMDB. Select the view on which you want to base the report.</p> |

Editing Pane

| | |
|---------------------|---|
| Description | <p>Create and define Report nodes and relationships.</p> <ul style="list-style-type: none"> ▶ When you select a folder in the Reports pane, the editing pane is empty. ▶ When you select a report in the Reports pane, the editing pane displays the TQL Report query, which consists of TQL nodes that are defined in the TQL query and the relationships between them, or the Gold Master report. |
| Useful Links | <p>“Add Nodes and Relationships to a TQL Query” on page 330</p> |

The following elements are included (unlabeled GUI elements are shown in angle brackets):

| GUI Element (A-Z) | Description |
|------------------------|--|
| <Context menu> options | For details, see “Context Menu Options” on page 339. |
| <Main Menu> | For details, see “Main Menu” on page 713. |
| <Node> | A component from which TQL queries are built. |

| GUI Element (A-Z) | Description |
|-------------------|--|
| <Relationship> | The entity that defines the relationship between two nodes. |
| <Toolbar> | For details, see “Toolbar Options” on page 717. |
| <Tooltips> | <p>Hold the cursor over a node or relationship to view its tooltip.</p> <p>The tooltips contain the following information:</p> <ul style="list-style-type: none"> ▶ Node Report Order: The order in which the Report node appears in the report. ▶ Node Report Label: A title for the selected Report node definition. For details, see Report Node Definition dialog box. ▶ Column Title: The title of each column for that node. For details, see Edit Attribute dialog box. |





The following elements are available by right-clicking a relationship. These options define how nodes are displayed in a generated report in relation to one another.

| GUI Element (A-Z) | Description |
|--------------------------------------|--|
| Add Relationship Folding Rule | <p>Enables you to define how nodes are displayed in a generated report in relation to one another.</p> <p>You can use one of the following options:</p> <p>Child. Define one Report node as a child of the Report node to which it is linked. In the report, the child Report nodes are displayed indented beneath the parent nodes.</p> <p>None. Does not define any rules for this relationship. In the Topology report, the Report nodes appear in different tables.</p> <p>Sibling. Define one Report node as a sibling of the Report node to which it is linked. In the report, the two Report nodes appear aligned with one another.</p> <p>SonGrid. Groups all the leaf instances in a table under their parent’s node. This option applies to leaf nodes only.</p> |

CI Type Selector

| | |
|------------------------------|--|
| Description | <p>Displays a hierarchical tree structure of the CI Types found in the CMDB. For more details, see “CI Type Manager User Interface” on page 216.</p> <p>Note: The number of instances of each CIT in the CMDB is displayed to the right of each CIT.</p> <p>To create or modify a TQL query, click and drag nodes to the Editing pane and define the relationship between them. Your changes are saved to the CMDB. For details, see “Add Nodes and Relationships to a TQL Query” in <i>Model Management</i>.</p> |
| Important Information | <p>The CI Type Selector is part of the following managers: View Manager, Enrichment Manager, Query Manager, Correlation Manager, Topology Report Manager, and Trigger TQL Editor.</p> |
| Included in Tasks | <ul style="list-style-type: none"> ➤ “Define a Correlation Rule – Workflow” on page 179 ➤ “Define an Enrichment Rule – Scenario” on page 300 ➤ “Define a TQL Query” on page 328 ➤ “Create a Pattern View” on page 144 ➤ “Define a Report Rule – Scenario” on page 246 |

The following elements are included (unlabeled GUI elements are shown in angle brackets>):

| GUI Element (A-Z) | Description |
|---|---|
|  | Click Add CI Type to Map to move the selected CI type to the Editing pane. |
|  | Click Refresh to refresh the CI type tree. |
|  | Click Search to search for the CI type entered. |
|  | Click Expand All to expand all subtrees within the CI type tree. |

| GUI Element (A-Z) | Description |
|---|---|
|  | Click Collapse All to collapse the subtrees within the CI type tree. |
| <Search window> | Enter the name or part of a name of a CI type for which to search. |

Context Menu Options



The CI Type Selector includes the following elements (listed alphabetically) available by right-clicking a CI Type:

| Menu Item | Description |
|---------------------------------|---|
| Add CI Type to Map | Select to add the selected CI type to the Editing pane. |
| Go to CI Type Definition | Takes you directly to the selected CI type in CIT Manager. |
| Show CIT Instances | Opens the Show All Instances window, which displays all instances of the selected CIT. For details, see “Element Instances Dialog Box” in <i>Model Management</i> . |

Information Pane

| | |
|------------------------------|---|
| Description | Displays the properties, conditions, and cardinality for the selected node and relationship. |
| Important Information | <p>The Information pane appears in the lower part of the window in the following managers and user interfaces: View Manager, Correlation Manager, Query Manager, Topology Report Manager, Enrichment Manager, Discovery Input TQL Editor, and Discovery Trigger TQL Editor.</p> <p>A small green indicator  appears next to the tabs in which a change occurred.</p> |
| Included in Tasks | <ul style="list-style-type: none"> ▶ “Define a Correlation Rule – Workflow” on page 179 ▶ “Define an Enrichment Rule – Scenario” on page 300 ▶ “Define a TQL Query” on page 328 ▶ “Create a Pattern View” on page 144 ▶ “Define a Report Rule – Scenario” on page 246 |

The following elements are included (unlabeled GUI elements are shown in angle brackets>):

| GUI Element (A-Z) | Description |
|---|---|
|  | If the window is not wide enough to display all the tabs, use the left and right arrows to move to the required tab. |
|  | Click Show List to display a list of the available tabs for the current manager. You can select a tab from the list. |
| Affected Nodes | <p>Displays which node is affected by the changes that occur in the selected trigger node. If required, you can click Edit to open and modify the Affected Nodes dialog box. For details, see “Affected Nodes Dialog Box” on page 186.</p> <p>Note: This tab appears only in Correlation Manager.</p> |
| Attributes | Displays the attribute conditions defined for the node or the relationship. For details, see “Attribute Tab” on page 377. |

| GUI Element (A-Z) | Description |
|-------------------------|---|
| Cardinality | Cardinality defines how many nodes you expect to have at the other end of a relationship. For example, in a relationship between host and IP, if the cardinality is 1:3, the TQL retrieves only those hosts that are connected to between one and three IPs. For details, see “Cardinality Tab” on page 379. |
| Details | <p>Displays the following information:</p> <ul style="list-style-type: none"> ▶ CI Type. The CIT of the selected node/relationship. ▶ Visible. A green check indicates that the selected node/relationship is visible in the topology map. A red mark indicates that it is not visible. ▶ Include subtypes. A green check indicates that both the selected CI and its children are displayed in the topology map. A red mark indicates that only the selected CI appears. |
| Edit | Click Edit to open the relevant dialog box for the selected tab. |
| Enrichment Rules | <p>Displays the Enrichment rule defined for the selected node or relationship. If the Enrichment rule is used to update the attributes of a CI, click Edit to open the Node/Relationship Definition dialog box and edit the rule if required. For details, see “Node/Relationship Definition Dialog Box” on page 318.</p> <p>Note: This tab appears only in Enrichment Manager.</p> |
| Folding Rule | <p>Displays the folding rule defined for the selected relationship. For details about folding rules, see “Adding Folding Rules to Relationships” on page 44.</p> <p>Note: This tab appears only when a relationship is selected in View Manager.</p> |
| Grouping | <p>Displays the different CI groupings for the selected node, as defined in the Grouping dialog box.</p> <p>Note: This tab appears only in View Manager.</p> |



| GUI Element (A-Z) | Description |
|----------------------------|---|
| Node Definition | <p>Displays the attributes to be included in the report for the selected node. If required, you can click Edit to open and modify the Report Node definition dialog box. For details, see “Report Node Definition Dialog Box” on page 276.</p> <p>Note: This tab appears only in Topology Report Manager.</p> |
| Qualifiers | <p>Displays the qualifier conditions defined for the node or the relationship. For details, see “Qualifier Tab” on page 382.</p> |
| Rule | <p>Displays the report folding rule defined for the selected relationship. For details about folding rules, see “Editing Pane” on page 270.</p> <p>Note: This tab appears only when a relationship is selected in Topology Report Manager.</p> |
| Selected Identities | <p>Displays the element instances that are used to define what should be included in the TQL results. For details, see “Identity Tab” on page 384.</p> |





Report Node Definition Dialog Box

| | |
|--------------------|---|
| Description | <p>Displays the node attributes that are included in the report, that is, the report’s columns. Each row in the table represents a column that appears in the report.</p> <p>You select the required attributes from the Add Attributes dialog box.</p> <p>To access: Right-click a node and select Report Node Definition.</p> |
|--------------------|---|

| | |
|------------------------------|---|
| Included in Tasks | “Define a Report Rule – Scenario” on page 246 |
| Important Information | <p>Only defined nodes are included in the final report. However, other nodes are included in the report calculations, since they are part of the TQL that the report reflects, and they can influence the data that is displayed in it. For example, in a Report TQL, which consists of a linked Host and IP, the IP has an attribute condition that states that only IPs that are in a critical state are included in the query results. Consequently, the report includes only hosts that are connected to IPs in a critical state, even if the IPs themselves are not included in the report.</p> <p>Note: The nodes to be included in the reports must be connected to each other through the TQL scenario. You cannot define nodes that are not linked to at least one other node that is included in the report.</p> |

The following elements are included (unlabeled GUI elements are shown in angle brackets>):

| GUI Element (A-Z) | Description |
|---|---|
|  | Select the attributes you want to appear in the report template. Opens the Add Attributes dialog box. |
|  | Define the function you want to perform on the Report node. Opens the Add Function dialog box. |

| GUI Element (A-Z) | Description |
|---|---|
|  | <p>Modify the attributes, functions and parameters, defined for each Report node.</p> <p>Enables you to:</p> <ul style="list-style-type: none"> ▶ Modify the name of the column title for that attribute. Select an attribute that displays attribute in the Function column. Opens the Add/Edit Attribute dialog box. ▶ Modify the functions and parameters you defined for the selected report node. Select an attribute that displays the parameters included for each node and the function (such as sum or max) performed on them in the Function and Parameter columns. Opens the Add/Edit Function dialog box. |
|  | <p>Delete the selected report node definition. A column for the node definition you deleted does not appear in the report.</p> |
|  | <p>Use the up and down arrows to determine the order of each node included in the report.</p> |
|  | <p>Define the sort order of the information reported for each Report node. Opens the Attribute Columns dialog box.</p> |
| <p>Field</p> | <p>Displays the nodes that are included in the report, that is, the report's columns.</p> <p>The title of the column as displayed in the Field box is the way the column title appears in the report template. By default, column titles take the same name as the selected attribute. You can change the title of the column in the Edit Attribute dialog box.</p> |
| <p>Parameters</p> | <p>Displays the parameters you defined for the Report node. For details, see the Add/Edit Function dialog box.</p> |
| <p>Title</p> | <p>A title for the selected Report node definition.</p> |
| <p>Type</p> | <p>Displays the functions you defined for the Report node. For details, see the Add/Edit Function dialog box.</p> |

Set Node Order Dialog Box

| | |
|--------------------------|--|
| Description | <p>Determine the order in which the Report nodes appear in the report.</p> <p>To access: Right-click any node displayed in the editing pane and select Node Order to open the Set Node Order dialog box.</p> <p>The Set Node Order dialog box displays a row for each node that is included in the report.</p> |
| Included in Tasks | “Define a Report Rule – Scenario” on page 246 |

The following elements are included (unlabeled GUI elements are shown in angle brackets>):

| GUI Element (A-Z) | Description |
|---|--|
|  | Use the up and down arrows to determine the order of each node included in the report. |
| Nodes | The list of nodes contained in the selected Report query. |

Set Report Parameters Wizard

| | |
|------------------------------|--|
| Description | <p>Displays all the parameterized values defined for the nodes in the TQL as configured in the Attribute tab in the Node/Relationship dialog box.</p> <p>Enables you to modify the value and then generate a report based on the changed value.</p> <p>To access: In the Reports pane, right-click a Report definition whose report was defined with parameterized values from the Attribute tab in the Node/Relationship dialog box.</p> |
| Important Information | <ul style="list-style-type: none"> ▶ Changing the value in the Set Report Parameters wizard changes what is displayed in the generated report and not the TQL query results. ▶ This dialog box is available only if you defined parameterized values in the Attribute tab in the Node/Relationship dialog box. |
| Included in Tasks | “Define a Report Rule – Scenario” on page 246 |
| Useful Links | “Topology Report” on page 591 |
| Wizard Map | <p>The Set Report Parameters Wizard contains:</p> <p>Set Parameters on <node> > Set Parameterized Values Summary Page</p> |

Set Parameters on <node>

| | |
|--------------------|---|
| Description | Enables you to modify the parameterized value and then generate a report based on the changed value. |
| Wizard Map | <p>The Set Report Parameters Wizard contains:</p> <p>Set Parameters on <node> > Set Parameterized Values Summary Page</p> |

The following elements are included (unlabeled GUI elements are shown in angle brackets):

| GUI Element (A-Z) | Description |
|-----------------------|--|
| Attribute name | The attribute used in the attribute condition. |
| Operator | The operator used in the attribute condition. |
| Value | The value of the attribute. |

Set Parameterized Values Summary Page

| | |
|--------------------|---|
| Description | Displays all the parameterized values defined for all the TQL's nodes as configured in the Attribute tab in the Node/Relationship dialog box. |
| Wizard Map | The Set Report Parameters Wizard contains: Set Parameters on <node> > Set Parameterized Values Summary Page |

The following elements are included (unlabeled GUI elements are shown in angle brackets):

| GUI Element (A-Z) | Description |
|------------------------|--|
| <Parameterized values> | Displays all the parameterized values defined for the TQL's nodes. |

Set View-specific Report Dialog Box

| | |
|--------------------|--|
| Description | Enables you to generate a report of the selected Report TQL query based on a specific view rather than the entire CMDB. To access: In the Reports pane, right-click a Report definition and select View-Specific Report . |
|--------------------|--|

| | |
|--------------------------|---|
| Included in Tasks | “Define a Report Rule – Scenario” on page 246 |
| Useful Links | “Topology Report” on page 591 |

The following elements are included (unlabeled GUI elements are shown in angle brackets>):

| GUI Element (A-Z) | Description |
|---|---|
|  | Click to open the Select View dialog box. Select the view on which you want to base the report. |
| View | Opens the View tree. Select the view on which you want to base the report. |

Troubleshooting and Limitations

You cannot create a new report if the report’s name contains more than 16 Japanese characters. For details, see “New Report/Report Properties/Save As Report Wizard” on page 263.

8

Query Manager

This chapter provides information on Query Manager.

This chapter includes:

Concepts

- ▶ Query Manager Overview on page 283

Tasks

- ▶ Create a TQL Query on page 285

Reference

- ▶ Query Manager User Interface on page 285

Query Manager Overview

Query Manager enables you to create TQL queries that can be used in other managers.

It is recommended to use the relevant managers (Correlation Manager, Enrichment Manager, View Manager, Topology Report Manager, Trigger TQL Editor) to create your TQL queries, rather than Query Manager. All TQL queries that are created in the other managers automatically appear in Query Manager.

You can use the Save As option in Query Manager to change the type of a TQL, so you do not have to recreate it. For details, see “Queries Pane” on page 289. Then, to see the query results in the Topology Map, you can create, in View Manager, a view based on the TQL query created in Query Manager.

Once you create and save a TQL query of the types View, Correlation, Enrichment, and Report, you cannot edit it. To edit a TQL of these types, you can go to the relevant manager, for example, the View Manager, and create a new view based on the TQL query that you created in Query Manager. Then you can edit the TQL query which was created in Query Manager, in the View Manager. Any changes you make to the query in the View Manager appear in the TQL query in Query Manager. You can only edit queries of the types Integration or Discovery in Query Manager.

You can display the retrieved data of the view's TQLs in a topology map where you can monitor the data. For details, see "Topology View Application" on page 515. The TQL resides in the system's memory and generates updated results automatically. For more information about Topology Query Language, see "Topology Query Language" on page 323.

Create a TQL Query

To create a TQL query, you need to create a TQL and then add the TQL nodes and relationships that define the query.

Select **Admin > Modeling > Query Manager** to open Query Manager. For details about how to create a TQL query, see “New Query/Save Query As/Query Properties Dialog Box” on page 285.

For details about how to add nodes and relationships to a query, see “Add Nodes and Relationships to a TQL Query” on page 330.

Query Manager User Interface

This section describes:

- New Query/Save Query As/Query Properties Dialog Box on page 285
- Query Manager Window on page 288

New Query/Save Query As/Query Properties Dialog Box

| | |
|------------------------------|--|
| Description | <p>Create or modify a TQL query.</p> <p>To access:</p> <ul style="list-style-type: none"> ➤ Right-click anywhere in the Queries pane and click New or click the New  button. or ➤ Right-click a TQL query and select Properties. |
| Important Information | <p>TQL queries are subject to certain validation restrictions. For details, see “Troubleshooting and Limitations” on page 401.</p> <p>If the TQL is not valid, you cannot save it.</p> |
| Included in Tasks | <p>“Create a TQL Query” on page 285</p> |

The following elements are included (unlabeled GUI elements are shown in angle brackets>):

| GUI Element (A-Z) | Description |
|--------------------------|---|
| Persistent | (Optional) Define whether the selected TQL should always remain in the system memory. Use this option only for frequently used TQLs. |
| Query Description | (Optional) Enter a description of the TQL query. |
| Query Name | Enter a unique name for the TQL query. |
| Query Priority | Select a priority level for the new TQL query (Low , Medium , High , or Express). This setting determines how often the query should be rerun automatically by the system to include updated information from the CMDB. Note: If you are creating a TQL of the type Enrichment , you can choose a priority of either Low or Medium only. |

| GUI Element (A-Z) | Description |
|-------------------|---|
| Query Type | <p>You can create a TQL query of the following types:</p> <ul style="list-style-type: none"> ▶ View. Creates queries for pattern views whose results are displayed in IT Universe. For details, see “View Manager” on page 129. <p>Note: Perspectives cannot be deleted from the Query Manager.</p> <ul style="list-style-type: none"> ▶ Correlation. Creates queries containing Correlation nodes, defined using the Correlation Manager. For details, see “Correlation Manager” on page 177. ▶ Enrichment. Creates queries containing Enrichment nodes and relationships. For details, see “Enrichment Manager” on page 297. ▶ Report. Creates queries whose results are compiled into reports using Topology Report Manager. For details, see “Topology Report Manager” on page 245. ▶ Discovery. Creates queries for use by the Discovery and Dependency Mapping (DDM) system. For details, see, “Trigger TQL Editor Window” in <i>Discovery and Dependency Mapping Guide</i>. ▶ Integration. Creates queries for use with the CMDB API. For details, see “The HP Universal CMDB Web Service API” in <i>Integrations</i>. <p>Note: Discovery TQLs should be created only by users who are thoroughly familiar with the DDM patterns used by the DDM system. For details, contact HP Software Support.</p> |









 **Query Manager Window**







| | |
|------------------------------|--|
| Description | <p>Enables you to query the CMDB by defining TQL queries or to change the type of an existing TQL.</p> <p>To access: Click Admin > Modeling > Query Manager.</p> |
| Important Information | <ul style="list-style-type: none"> ▶ It is recommended to use the relevant Managers (Correlation Manager, Enrichment Manager, View Manager, Topology Report Manager, Trigger TQL Editor) to create your TQL queries, rather than Query Manager. All TQLs that are created in the other managers automatically appear in Query Manager. You can use the Save As option in Query Manager to change the type of TQL, so you do not have to recreate it. For details, see “Queries Pane” on page 289. ▶ Once you create and save a TQL query of the types View, Correlation, Enrichment, and Report, you cannot edit it. To edit a TQL of these types, you can go to the relevant manager, for example, the View Manager, and create a new view based on the TQL query that you created in Query Manager. You can then edit the TQL query (which was created in Query Manager) in the View Manager. Any changes you make to the query in the View Manager appear in the TQL query in Query Manager. You can only edit queries of the Integration or Discovery types in Query Manager. ▶ For TQL queries to be valid, they must comply with the restrictions described in “Troubleshooting and Limitations” on page 401. |
| Useful Links | <p>“Topology Query Language (TQL) Overview” on page 324</p> |

Queries Pane

| | |
|--------------------|--|
| Description | <p>Displays a hierarchical tree structure of predefined folders and TQL queries.</p> <p>You can create your own query, or work with the default queries provided with your HP Universal CMDB installation.</p> <p>Predefined folders are provided for the out-of-the-box queries; you can modify these folders, or add additional folders according to your organization's requirements.</p> |
|--------------------|--|

The following elements are included (unlabeled GUI elements are shown in angle brackets>):

| GUI Element (A-Z) | Description |
|---|--|
|  | Creates a new folder. |
|  | Enables you to create a TQL query of the types View, Correlation, Enrichment, Report, Discovery, or Integration. You can only edit queries of the types Integration or Discovery in Query Manager. Opens the New Query dialog box. |
|  | Deletes the selected folder or TQL query. |
|  | Refreshes the data content of the hierarchical tree structure that may have been modified by other users. |
|  | (Enabled only when a TQL query is created or when changes are made to an existing one.) Save the TQL query to the CMDB. |
|  | Opens the Query Properties dialog box. For a description, see "Properties" below. |
|  | Generates a preview of the results of the selected TQL query. |
|  | Represents a folder. |
|  | Represents a TQL query of the type Integration. |

| GUI Element (A-Z) | Description |
|---|--|
|  | Represents a TQL query of the type (pattern) View. |
|  | Represents a TQL query of the type Template. |
|  | Represents a TQL query of the type Perspective. |
|  | Represents a TQL query of the type Correlation. |
|  | Represents a TQL query of the type Enrichment. |
|  | Represents a TQL query of the type Report. |
|  | Represents a TQL query of the type Discovery. |

The following elements are available by right-clicking a folder or a TQL query:

| GUI Element (A-Z) | Description |
|-------------------|---|
| Delete | Delete the selected folder or TQL query. |
| Export | Displays a standard Save As dialog box, enabling you to save the TQL query in XML script format. This option can be used to move TQL queries from one workstation to another. |
| Import | Imports XML files that contain saved TQL queries to Query Manager. |
| New | Create a TQL query. For details, see “New Query/Save Query As/Query Properties Dialog Box” on page 285. |
| New Folder | Create a new folder. |
| Preview | Generates a preview of the results of the selected TQL query. |
| Properties | Opens the TQL Properties dialog box. Enables you to change the priority and description of the selected TQL query, and define whether the TQL should always remain in the system memory (Persistent). |

| GUI Element (A-Z) | Description |
|----------------------|--|
| Rename Folder | Rename the folder. |
| Save | (Enabled only when a new TQL is created or when changes are made to an existing TQL) Save the query to the CMDB after you have defined the specific attribute conditions of the nodes and relationships in the query. Note: If you exit the Query Manager without saving, a confirmation dialog box is displayed, requesting that you save your query. |
| Save As | Opens the Save Query As dialog box, enabling you to create a query by copying an existing one. You can change the type of the query. For a description of the available query types, see “Query Type” on page 287. |

Editing Pane

| | |
|---------------------|---|
| Description | Displays the currently selected TQL. <ul style="list-style-type: none"> ▶ When you select a folder in the Queries pane, the editing pane is empty. ▶ When you select a TQL query in the Queries pane, the editing pane displays the selected query, which consists of TQL nodes that are defined in the TQL query and the relationships between them. |
| Useful Links | “Add Nodes and Relationships to a TQL Query” on page 330. |

The following elements are included (unlabeled GUI elements are shown in angle brackets):

| GUI Element (A-Z) | Description |
|------------------------|--|
| <Context menu> options | For details, see “Context Menu Options” on page 339. |
| <Main Menu> | For details, see “Main Menu” on page 713. |
| <Node> | A component from which TQL queries are built. |





| GUI Element (A-Z) | Description |
|-------------------|---|
| <Relationship> | The entity that defines the relationship between two nodes. |
| <toolbar> | For details, see “Toolbar Options” on page 717. |
| <tooltips> | <p>Hold the cursor over a node or relationship to view its tooltip.</p> <p>The tooltips contain the following information:</p> <ul style="list-style-type: none"> ▶ Element name. The name of the node. ▶ CI Type. The CIT of the node as defined in the CI Type Manager. For details, see “CI Type Manager” on page 205. ▶ Definitions of the selected nodes and relationships. The attribute conditions, as described in “Node/Relationship Properties Dialog Box” on page 375. |

CI Type Selector

| | |
|------------------------------|--|
| Description | <p>Displays a hierarchical tree structure of the CI Types found in the CMDB. For more details, see “CI Type Manager User Interface” on page 216.</p> <p>Note: The number of instances of each CIT in the CMDB is displayed to the right of each CIT.</p> <p>To create or modify a TQL query, click and drag nodes to the Editing pane and define the relationship between them. Your changes are saved to the CMDB. For details, see “Add Nodes and Relationships to a TQL Query” in <i>Model Management</i>.</p> |
| Important Information | <p>The CI Type Selector is part of the following managers: View Manager, Enrichment Manager, Query Manager, Correlation Manager, Topology Report Manager, and Trigger TQL Editor.</p> |

| | |
|--------------------------|--|
| Included in Tasks | <ul style="list-style-type: none"> ➤ “Define a Correlation Rule – Workflow” on page 179 ➤ “Define an Enrichment Rule – Scenario” on page 300 ➤ “Define a TQL Query” on page 328 ➤ “Create a Pattern View” on page 144 ➤ “Define a Report Rule – Scenario” on page 246 |
|--------------------------|--|

The following elements are included (unlabeled GUI elements are shown in angle brackets):

| GUI Element (A-Z) | Description |
|---|---|
|  | Click Add CI Type to Map to move the selected CI type to the Editing pane. |
|  | Click Refresh to refresh the CI type tree. |
|  | Click Search to search for the CI type entered. |
|  | Click Expand All to expand all subtrees within the CI type tree. |
|  | Click Collapse All to collapse the subtrees within the CI type tree. |
| <Search window> | Enter the name or part of a name of a CI type for which to search. |

Context Menu Options



The CI Type Selector includes the following elements (listed alphabetically) available by right-clicking a CI Type:

| Menu Item | Description |
|---------------------------------|---|
| Add CI Type to Map | Select to add the selected CI type to the Editing pane. |
| Go to CI Type Definition | Takes you directly to the selected CI type in CIT Manager. |
| Show CIT Instances | Opens the Show All Instances window, which displays all instances of the selected CIT. For details, see “Element Instances Dialog Box” in <i>Model Management</i> . |

Information Pane

| | |
|------------------------------|---|
| Description | Displays the properties, conditions, and cardinality for the selected node and relationship. |
| Important Information | <p>The Information pane appears in the lower part of the window in the following managers and user interfaces: View Manager, Correlation Manager, Query Manager, Topology Report Manager, Enrichment Manager, Discovery Input TQL Editor, and Discovery Trigger TQL Editor.</p> <p>A small green indicator  appears next to the tabs in which a change occurred.</p> |
| Included in Tasks | <ul style="list-style-type: none"> ➤ “Define a Correlation Rule – Workflow” on page 179 ➤ “Define an Enrichment Rule – Scenario” on page 300 ➤ “Define a TQL Query” on page 328 ➤ “Create a Pattern View” on page 144 ➤ “Define a Report Rule – Scenario” on page 246 |

The following elements are included (unlabeled GUI elements are shown in angle brackets>):

| GUI Element (A-Z) | Description |
|---|--|
|  | If the window is not wide enough to display all the tabs, use the left and right arrows to move to the required tab. |
|  | Click Show List to display a list of the available tabs for the current manager. You can select a tab from the list. |
| Affected Nodes | Displays which node is affected by the changes that occur in the selected trigger node. If required, you can click Edit to open and modify the Affected Nodes dialog box. For details, see “Affected Nodes Dialog Box” on page 186. Note: This tab appears only in Correlation Manager. |
| Attributes | Displays the attribute conditions defined for the node or the relationship. For details, see “Attribute Tab” on page 377. |
| Cardinality | Cardinality defines how many nodes you expect to have at the other end of a relationship. For example, in a relationship between host and IP, if the cardinality is 1:3, the TQL retrieves only those hosts that are connected to between one and three IPs. For details, see “Cardinality Tab” on page 379. |
| Details | Displays the following information: <ul style="list-style-type: none"> ▶ CI Type. The CIT of the selected node/relationship. ▶ Visible. A green check indicates that the selected node/relationship is visible in the topology map. A red mark indicates that it is not visible. ▶ Include subtypes. A green check indicates that both the selected CI and its children are displayed in the topology map. A red mark indicates that only the selected CI appears. |
| Edit | Click Edit to open the relevant dialog box for the selected tab. |

| GUI Element (A-Z) | Description |
|----------------------------|---|
| Enrichment Rules | <p>Displays the Enrichment rule defined for the selected node or relationship. If the Enrichment rule is used to update the attributes of a CI, click Edit to open the Node/Relationship Definition dialog box and edit the rule if required. For details, see “Node/Relationship Definition Dialog Box” on page 318.</p> <p>Note: This tab appears only in Enrichment Manager.</p> |
| Folding Rule | <p>Displays the folding rule defined for the selected relationship. For details about folding rules, see “Adding Folding Rules to Relationships” on page 44.</p> <p>Note: This tab appears only when a relationship is selected in View Manager.</p> |
| Grouping | <p>Displays the different CI groupings for the selected node, as defined in the Grouping dialog box.</p> <p>Note: This tab appears only in View Manager.</p> |
| Node Definition | <p>Displays the attributes to be included in the report for the selected node. If required, you can click Edit to open and modify the Report Node definition dialog box. For details, see “Report Node Definition Dialog Box” on page 276.</p> <p>Note: This tab appears only in Topology Report Manager.</p> |
| Qualifiers | <p>Displays the qualifier conditions defined for the node or the relationship. For details, see “Qualifier Tab” on page 382.</p> |
| Rule | <p>Displays the report folding rule defined for the selected relationship. For details about folding rules, see “Editing Pane” on page 270.</p> <p>Note: This tab appears only when a relationship is selected in Topology Report Manager.</p> |
| Selected Identities | <p>Displays the element instances that are used to define what should be included in the TQL results. For details, see “Identity Tab” on page 384.</p> |

9

Enrichment Manager

This chapter provides information on Enrichment Manager.

This chapter includes:

Concepts

- ▶ Enrichment Manager Overview on page 297

Tasks

- ▶ Define an Enrichment Rule – Scenario on page 300

Reference

- ▶ Enrichment Manager User Interface on page 303

Enrichment Manager Overview

Enrichment rules can be used for several purposes:

- ▶ Adding new CIs and relationships to the CMDB.
- ▶ Deleting specific CI instances from the CMDB.
- ▶ Updating the attribute values of specific CI instances in the CMDB.

Enrichment nodes and relationships differ from other nodes and relationships in that they are conceptual deductions that represent real relationships and CIs that cannot be discovered automatically by the discovery process.

Enrichment nodes and relationships are created as part of a TQL, whose other TQL nodes are regular ones, meaning TQL nodes that already exist in the CMDB. For more information about TQL queries, see “Topology Query Language” on page 323.

The following example displays a regular **Host** node linked to an **IBM Websphere MQ Enrichment** node by an Enrichment **Container link** relationship.

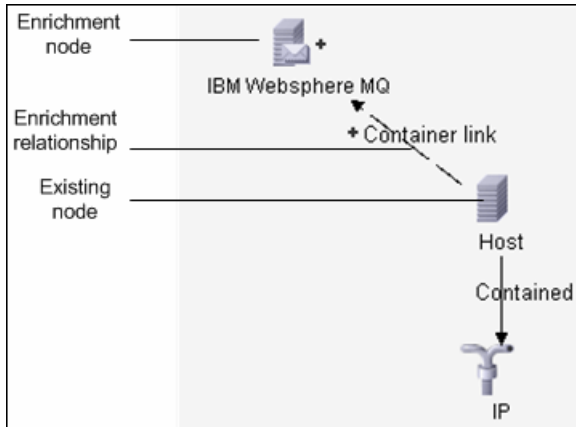

By placing an Enrichment node within a TQL query context, the query receives data from its attributes, and uses it to insert new information into the CMDB.

When you create Enrichment rules, the following results can occur:

- ▶ **The CMDB is enlarged.** Add Enrichment nodes and relationships that are currently not included in the CMDB.

The following Enrichment rule example displays a regular **Windows** node (that already exists in the CMDB) connected to a **File** Enrichment node by an Enrichment **Container link** relationship.

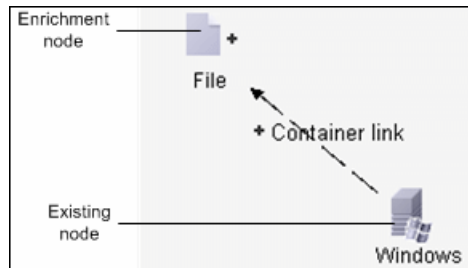

This Enrichment rule states that for every **Windows** CI instance that is found in the CMDB, a new **File** CI instance is created, and linked to the **Windows** CI with a **Container link** relationship.

- ▶ **Specific CI instances are deleted from the CMDB.** For an example, see “Define an Enrichment Rule – Scenario” on page 300.
- ▶ **The values of CI attributes are updated.** Use an Enrichment rule to update the attributes of a CI that already exists in the CMDB.

The following Enrichment rule example illustrates that a regular **File System** node (that already exists in the CMDB) has been updated with an Enrichment rule.



File System

This Enrichment rule states that every **File System** CI found in the CMDB is updated with the attribute value defined in the Enrichment rule.

Define an Enrichment Rule – Scenario

This task describes how to create an Enrichment rule where, for every instance in the CMDB in which an **IP** CI is connected to two identical **Host** CIs, but one **Host** CI is identified by its IP address and the other host is identified by its lowest MAC address, the **Host** CI that is identified by its IP address is deleted from the CMDB.

Note: To reach the required result, you must implement each one of the following steps.

This task includes the following steps:

- ▶ “Create an Enrichment TQL Query” on page 300
- ▶ “Define the Host Node that Is Identified by its Lowest MAC Address” on page 302
- ▶ “Define the Host Node that is Identified by its IP Address” on page 302
- ▶ “Define the Enrichment Rule” on page 303

1 Create an Enrichment TQL Query

To create an Enrichment TQL query, you need to define an Enrichment rule and then add the regular TQL nodes and relationships that define the query.

Note: You can add Enrichment nodes and relationships only after at least one regular node has been added to the query. In this task, you must first add regular nodes and relationships.

Select **Admin > Modeling > Enrichment Manager**. For details about how to create an Enrichment TQL query, see “New Enrichment Rule/Enrichment Rule Properties/Save As Enrichment Rule Wizard” on page 314. For details about how to add nodes and relationships to a query, see “Add Nodes and Relationships to a TQL Query” on page 330.

Example of an Enrichment TQL Query

A new Enrichment TQL query called `doubleHosts1` (located under the **Network** folder) is created in the Enrichment Manager.

The screenshot shows the configuration for the `doubleHosts1` rule. The **Rule Name** field contains `doubleHosts1`. The **Rule Description** field contains the text "Delete incomplete host". At the bottom, there is a checkbox labeled **Rule is Active** which is checked.

The **doubleHosts1** Enrichment rule is displayed in the Enrichment Rules pane.

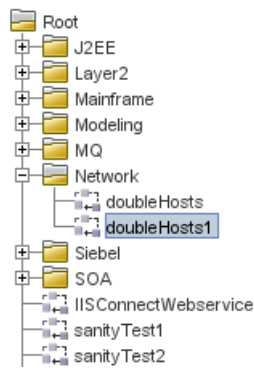

In this Enrichment TQL query, an **IP** node is linked to two **Host** nodes by a **Contained** relationship. The TQL results must comply with the direction of the arrows.

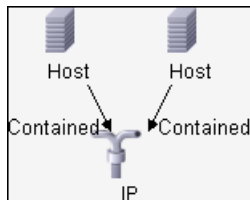

Note: A TQL query is subject to certain validation restrictions. For details, see “Troubleshooting and Limitations” on page 401.

2 Define the Host Node that Is Identified by its Lowest MAC Address

At the top of the Enrichment Manager window, select **TQL** mode. In the editing pane, right-click the required **Host** node, select **Node Properties** to open the Node Properties dialog box. Then define an attribute condition in the Attribute tab. For details on how to define an attribute condition, see “Attribute Tab” on page 377.

Example of an Attribute Condition Definition that Identifies the Host by its Lowest Mac Address

In the Attribute tab, this attribute condition definition identifies the required Host by its lowest MAC address.

- **Attribute name** — Host is Complete
- **Operator** — Equal
- **Value** — True

3 Define the Host Node that is Identified by its IP Address

At the top of the Enrichment Manager window, select **TQL** mode. In the editing pane, right-click the required **Host** node, and select **Node Properties** to open the Node Properties dialog box. Then define two attribute conditions in the Attribute tab. For details on how to define an attribute condition, see “Attribute Tab” on page 377.

Example of an Attribute Condition that Enables a Host to Be Identified by its IP Address

This attribute condition is the first attribute condition you need to define in the Attribute tab to enable the Host node to be identified by its IP address.

- **Attribute name** — Host is Complete
- **Operator** — Equal

- **Value** — False

This is the second attribute condition you need to define in the Attribute tab to enable the Host node to be identified by its IP address.

- **Attribute name** — Host is Complete

- **Operator** — Is null

- **Value** — Value cannot be changed

4 Define the Enrichment Rule

Define the Enrichment rule that deletes all instances of the **Host** node that are identified by their IP address. From the Enrichment Manager window toolbar, select **Enrichment** mode. In the Enrichment Rules pane, select the **doubleHosts1** Enrichment rule. Then right-click the **Host** node that is identified by its IP address and select **Delete Relationship/Node Item**.

Example of a Host Node Containing a Removed Indicator

The **Host** node now has a removed indicator to denote that all host instances that have identical attribute and cardinality settings are removed from the CMDB. The Enrichment query now looks like this.

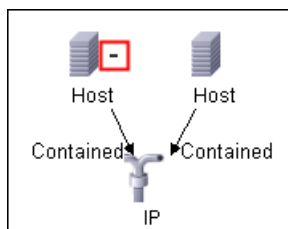

Enrichment Manager User Interface

This section describes:

- Enrichment Manager Window on page 304
- New Enrichment Rule/Enrichment Rule Properties/Save As Enrichment Rule Wizard on page 314

- ▶ Node/Relationship Definition Dialog Box on page 318
- ▶ Node Definition – Advanced Attribute Dialog Box on page 320









Enrichment Manager Window

| | |
|------------------------------|---|
| Description | <p>Define Enrichment rules. These rules, which are based on a specific TQL query, can be used for several purposes:</p> <ul style="list-style-type: none"> ▶ Adding new CIs and relationships to the CMDB. ▶ Deleting specific CI instances from the CMDB. ▶ Updating the attribute values of specific CI instances in the CMDB. <p>To access: Select Admin > Modeling > Enrichment Manager.</p> |
| Important Information | <p>Enrichment Manager has two modes in which you can work. Always check the Enrichment/TQL mode list in the toolbar to verify the currently selected mode.</p> |
| Included in Tasks | <p>“Define an Enrichment Rule – Scenario” on page 300</p> |

Enrichment Rules Pane

| | |
|--------------------|--|
| Description | <p>Displays a hierarchical tree structure of predefined folders and Enrichment rules. Each Enrichment rule is associated with a TQL query.</p> <p>You can create your own query, or work with the out-of-the-box (factory) queries provided with your HP Universal CMDB installation.</p> <p>The default folders are provided for the out-of-the-box queries. You can modify these folders, or add additional folders according to your organization’s requirements.</p> |
|--------------------|--|

The following elements are included (unlabeled GUI elements are shown in angle brackets>):

| GUI Element (A-Z) | Description |
|--|---|
|  | Creates a new folder. |
|  | Creates an Enrichment rule. Opens the New Enrichment Rule/Properties wizard. |
|  | Deletes the selected folder or Enrichment rule. |
|  | Refreshes the data content of the hierarchical tree structure that may have been modified by other users. |
|  | (Enabled only when an Enrichment rule is created or when changes are made to an existing one.) Saves the Enrichment rule to the CMDB. |
|  | Opens the New Enrichment Rule/Properties wizard. Enables you to change the description and the activation state of the Enrichment rule. |
|  | Generates a preview of the results of the selected Enrichment rule. |
|  | Represents a folder. |
|  | Represents an Enrichment rule. |

The following elements are available by right-clicking a folder or Enrichment rule:



| GUI Element (A-Z) | Description |
|-------------------|--|
| Delete | Deletes the selected folder or Enrichment rule. |
| Export | Displays a standard Save As dialog box, enabling you to save the Enrichment rule as an XML script. This option can be used to move an Enrichment rule from one workstation to another, provided the related TQL query is also relocated. |

| GUI Element (A-Z) | Description |
|----------------------|--|
| Import | Imports XML files that contain saved Enrichment queries to the Enrichment Manager. |
| New | Creates an Enrichment rule. Opens the New Enrichment Rule dialog box. |
| New Folder | Creates a new folder. |
| Preview | Generates a preview of the results of the selected Enrichment rule. |
| Properties | Opens the New Enrichment Rule/Properties dialog box. Enables you to change the description and the activation state of the rule. |
| Rename Folder | Renames the folder |
| Save | (Enabled only when a new Enrichment query is created or when changes are made to an existing one.) Saves the Enrichment rule to the CMDB. |
| Save As | Displays the Save As dialog box, enabling you to define a new name and description for a query. This option can be used for creating a new Enrichment rule based on an existing one. |

Editing Pane

| | |
|------------------------------|---|
| Description | <p>Create and define Enrichment nodes and relationships.</p> <ul style="list-style-type: none"> ▶ When you select a folder in the Enrichment Rules pane, the editing pane is empty. ▶ When you select an Enrichment rule in the Enrichment Rules pane, the editing pane displays the selected rule, which consists of TQL nodes that are defined in the TQL query and the relationships between them, and the Enrichment nodes and relationships that are created and added to the rule. |
| Important Information | <ul style="list-style-type: none"> ▶ The Enrichment Manager has two modes in which you can work: Enrichment mode and TQL mode. The right-click options that appear when you click a node or relationship depends on the which mode in which you are working. For details, see the editing pane description below. ▶ You can calculate the number of instances that were created as a result of an Enrichment rule and remove the instances created from an Enrichment rule from the CMDB. For details, see “Additions Count” on page 717 and “Remove Enrichment Results” on page 722. |
| Included in Tasks | “Define an Enrichment Rule – Scenario” on page 300 |
| Useful Links | For details on how to create a TQL query, see “Add Nodes and Relationships to a TQL Query” on page 330. |

The following elements are included (unlabeled GUI elements are shown in angle brackets>):



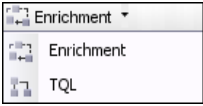

| GUI Element (A-Z) | Description |
|---|---|
|  | Indicates an added Enrichment node or relationship. |
|  | Indicates a node or relationship that has been deleted from the CMDB. |
|  | Indicates an updated node or relationship. |

| GUI Element (A-Z) | Description |
|---|---|
|  <p>TQL and Enrichment mode</p> | <p>The Enrichment Manager has two modes in which you can work: Enrichment mode and TQL mode.</p> <p>Working in:</p> <ul style="list-style-type: none"> ▶ TQL mode enables you to define regular (non-Enrichment) relationships and nodes and add them to the TQL query you defined. ▶ Enrichment mode enables you to define Enrichment relationships and nodes and add them to the TQL query you defined. |
| <Context menu> options | For details, see “Context Menu Options” on page 339. |
| <Main Menu> | For details, see “Main Menu” on page 713. |
| <Node> | A component from which TQL queries are built. |
| <Relationship> | The entity that defines the relationship between two nodes. |
| <Toolbar> | For details, see “Toolbar Options” on page 717. |
| <Tooltips> | <p>Hold the cursor over a node or relationship to view its tooltip.</p> <p>The tooltips contain the following information:</p> <ul style="list-style-type: none"> ▶ Element name. The name of the node. ▶ CI Type. The CIT of the node as defined in the CI Type Manager. For details, see “CI Type Manager” on page 205. ▶ Definitions of the selected nodes and relationships. The attribute conditions, as described in “Node/Relationship Properties Dialog Box” on page 375. |

CI Type Selector

| | |
|------------------------------|--|
| Description | <p>Displays a hierarchical tree structure of the CI Types found in the CMDB. For more details, see “CI Type Manager User Interface” on page 216.</p> <p>Note: The number of instances of each CIT in the CMDB is displayed to the right of each CIT.</p> <p>To create or modify a TQL query, click and drag nodes to the Editing pane and define the relationship between them. Your changes are saved to the CMDB. For details, see “Add Nodes and Relationships to a TQL Query” in <i>Model Management</i>.</p> |
| Important Information | <p>The CI Type Selector is part of the following managers: View Manager, Enrichment Manager, Query Manager, Correlation Manager, Topology Report Manager, and Trigger TQL Editor.</p> |
| Included in Tasks | <ul style="list-style-type: none"> ▶ “Define a Correlation Rule – Workflow” on page 179 ▶ “Define an Enrichment Rule – Scenario” on page 300 ▶ “Define a TQL Query” on page 328 ▶ “Create a Pattern View” on page 144 ▶ “Define a Report Rule – Scenario” on page 246 |

The following elements are included (unlabeled GUI elements are shown in angle brackets>):

| GUI Element (A-Z) | Description |
|---|---|
|  | Click Add CI Type to Map to move the selected CI type to the Editing pane. |
|  | Click Refresh to refresh the CI type tree. |
|  | Click Search to search for the CI type entered. |
|  | Click Expand All to expand all subtrees within the CI type tree. |

| GUI Element (A-Z) | Description |
|---|---|
|  | Click Collapse All to collapse the subtrees within the CI type tree. |
| <Search window> | Enter the name or part of a name of a CI type for which to search. |

Context Menu Options



The CI Type Selector includes the following elements (listed alphabetically) available by right-clicking a CI Type:

| Menu Item | Description |
|---------------------------------|---|
| Add CI Type to Map | Select to add the selected CI type to the Editing pane. |
| Go to CI Type Definition | Takes you directly to the selected CI type in CIT Manager. |
| Show CIT Instances | Opens the Show All Instances window, which displays all instances of the selected CIT. For details, see “Element Instances Dialog Box” in <i>Model Management</i> . |

Information Pane

| | |
|------------------------------|---|
| Description | Displays the properties, conditions, and cardinality for the selected node and relationship. |
| Important Information | <p>The Information pane appears in the lower part of the window in the following managers and user interfaces: View Manager, Correlation Manager, Query Manager, Topology Report Manager, Enrichment Manager, Discovery Input TQL Editor, and Discovery Trigger TQL Editor.</p> <p>A small green indicator * appears next to the tabs in which a change occurred.</p> |
| Included in Tasks | <ul style="list-style-type: none"> ➤ “Define a Correlation Rule – Workflow” on page 179 ➤ “Define an Enrichment Rule – Scenario” on page 300 ➤ “Define a TQL Query” on page 328 ➤ “Create a Pattern View” on page 144 ➤ “Define a Report Rule – Scenario” on page 246 |

The following elements are included (unlabeled GUI elements are shown in angle brackets>):

| GUI Element (A-Z) | Description |
|---|---|
|  | If the window is not wide enough to display all the tabs, use the left and right arrows to move to the required tab. |
|  | Click Show List to display a list of the available tabs for the current manager. You can select a tab from the list. |
| Affected Nodes | Displays which node is affected by the changes that occur in the selected trigger node. If required, you can click Edit to open and modify the Affected Nodes dialog box. For details, see “Affected Nodes Dialog Box” on page 186. Note: This tab appears only in Correlation Manager. |
| Attributes | Displays the attribute conditions defined for the node or the relationship. For details, see “Attribute Tab” on page 377. |
| Cardinality | Cardinality defines how many nodes you expect to have at the other end of a relationship. For example, in a relationship between host and IP, if the cardinality is 1:3, the TQL retrieves only those hosts that are connected to between one and three IPs. For details, see “Cardinality Tab” on page 379. |
| Details | Displays the following information: <ul style="list-style-type: none"> ▶ CI Type. The CIT of the selected node/relationship. ▶ Visible. A green check indicates that the selected node/relationship is visible in the topology map. A red mark indicates that it is not visible. ▶ Include subtypes. A green check indicates that both the selected CI and its children are displayed in the topology map. A red mark indicates that only the selected CI appears. |
| Edit | Click Edit to open the relevant dialog box for the selected tab. |

| GUI Element (A-Z) | Description |
|----------------------------|---|
| Enrichment Rules | <p>Displays the Enrichment rule defined for the selected node or relationship. If the Enrichment rule is used to update the attributes of a CI, click Edit to open the Node/Relationship Definition dialog box and edit the rule if required. For details, see “Node/Relationship Definition Dialog Box” on page 318.</p> <p>Note: This tab appears only in Enrichment Manager.</p> |
| Folding Rule | <p>Displays the folding rule defined for the selected relationship. For details about folding rules, see “Adding Folding Rules to Relationships” on page 44.</p> <p>Note: This tab appears only when a relationship is selected in View Manager.</p> |
| Grouping | <p>Displays the different CI groupings for the selected node, as defined in the Grouping dialog box.</p> <p>Note: This tab appears only in View Manager.</p> |
| Node Definition | <p>Displays the attributes to be included in the report for the selected node. If required, you can click Edit to open and modify the Report Node definition dialog box. For details, see “Report Node Definition Dialog Box” on page 276.</p> <p>Note: This tab appears only in Topology Report Manager.</p> |
| Qualifiers | <p>Displays the qualifier conditions defined for the node or the relationship. For details, see “Qualifier Tab” on page 382.</p> |
| Rule | <p>Displays the report folding rule defined for the selected relationship. For details about folding rules, see “Editing Pane” on page 270.</p> <p>Note: This tab appears only when a relationship is selected in Topology Report Manager.</p> |
| Selected Identities | <p>Displays the element instances that are used to define what should be included in the TQL results. For details, see “Identity Tab” on page 384.</p> |

New Enrichment Rule/Enrichment Rule Properties/Save As Enrichment Rule Wizard

| | |
|------------------------------|--|
| Description | <p>Creates or modifies an Enrichment rule.</p> <p>To access:</p> <ul style="list-style-type: none"> ▶ To create a new Enrichment rule, right-click anywhere in the Enrichment Rules pane and click New or click the New  button. ▶ To modify an existing Enrichment rule, right-click an Enrichment rule in the Enrichment Rules pane and select Properties. ▶ To create a new Enrichment rule based on an existing query, right-click an Enrichment rule in the Enrichment Rules pane and select Save As. |
| Included in Tasks | “Define an Enrichment Rule – Scenario” on page 300 |
| Important Information | <ul style="list-style-type: none"> ▶ When creating a new Enrichment rule, bear in mind that the application does not allow you to make any changes in the TQL that are necessary for the rule. These changes include the following: <ul style="list-style-type: none"> ▶ Deleting, from the Enrichment TQL, the nodes or relationships connected to the Enrichment node, causing a node to become unattached to any relationship. ▶ You cannot change the cardinality definition to 0 (not required) of a node or relationship that is used in an Enrichment rule. For details on relationship cardinality, see “Node/Relationship Properties Dialog Box” on page 375. ▶ An Enrichment TQL that serves as the basis for Enrichment rules, is subject to certain validation restrictions. For details, see “Troubleshooting and Limitations” on page 401. If the TQL is not valid, you cannot save it. |
| Useful links | “Topology Query Language” on page 323 |
| Wizard Map | <p>The New Enrichment Rule /Enrichment Rule Properties/Save As Correlation Rule wizard contains:</p> <p>Rule General Attributes Page > Rule Base TQL Page</p> |

 **Rule General Attributes Page**

| | |
|------------------------------|--|
| Description | Enables you to enter a unique name and description for the Enrichment rule. |
| Included in Tasks | “Define an Enrichment Rule – Scenario” on page 300 |
| Important Information | <ul style="list-style-type: none"> ▶ An Enrichment TQL that serves as the basis for Enrichment rules, is subject to certain validation restrictions. For details, see “Troubleshooting and Limitations” on page 401. If the TQL is not valid, you cannot save it. ▶ For important information on the effects of making changes to the TQL after creating it, see “New Enrichment Rule/Enrichment Rule Properties/Save As Enrichment Rule Wizard” on page 314. ▶ By default, this wizard is set to display a Welcome page. You can choose not to display this page by changing the user preferences. For details, see “User Preferences Dialog Box” on page 400. |
| Useful Links | “Topology Query Language” on page 323 |
| Wizard Map | The New Enrichment Rule/Enrichment Rule Properties/Save As Enrichment Rule Wizard contains: Rule General Attributes Page > Rule Base TQL Page |

The following elements are included (unlabeled GUI elements are shown in angle brackets>):

| GUI Element (A-Z) | Description |
|----------------------------------|--|
| Description | (Optional) Enter a description of the rule. |
| Enrichment Rule is Active | <p>(Optional) Select this option to activate the rule in the system as soon as it is saved.</p> <p>Default: Not selected</p> <p>Notes:</p> <ul style="list-style-type: none"> ▶ If an active Enrichment rule is deactivated (by clearing the Enrichment Rule is Active check box), all changes that occurred in the CMDB relating to the rule are deleted from the system. When you deactivate an Enrichment rule, a red X appears next to the Enrichment rule in the Enrichment Rules pane. ▶ To reactivate the rule, right-click the rule in the Enrichment Rules pane and select Properties. In the General Attributes page, select Enrichment Rule is Active. |
| Rule Name | <p>Enter a unique name for the Enrichment rule.</p> <p>The rule name cannot contain any of the following characters: \ / : " < > % ?</p> <p>Note: If the Enrichment rule name is either empty, contains a name used by another Enrichment rule, or uses invalid characters, the Next and Finish buttons are disabled.</p> |

 **Rule Base TQL Page**

| | |
|------------------------------|---|
| Description | Enables you to define the properties of the TQL on which the Enrichment rule is based. |
| Included in Tasks | “Define an Enrichment Rule – Scenario” on page 300 |
| Important Information | <ul style="list-style-type: none"> ▶ An Enrichment TQL that serves as the basis for Enrichment rules, is subject to certain validation restrictions. For details, see “Troubleshooting and Limitations” on page 401. If the TQL is not valid, you cannot save it. ▶ For important information on the effects of making changes to the TQL after creating it, see “New Enrichment Rule/Enrichment Rule Properties/Save As Enrichment Rule Wizard” on page 314. ▶ By default, this wizard is set to display a Completion page after clicking Next in this page. You can choose not to display the Completion page by changing the user preferences. For details, see “User Preferences Dialog Box” on page 400. |
| Useful Links | “Topology Query Language” on page 323 |
| Wizard Map | The New Enrichment Rule/Enrichment Rule Properties/Save As Enrichment Rule Wizard contains: Rule General Attributes Page > Rule Base TQL Page |

The following elements are included (unlabeled GUI elements are shown in angle brackets>):

| GUI Element (A-Z) | Description |
|--|--|
| Base the Enrichment rule on a new TQL | Select this check box if you want to base the Enrichment rule on a new TQL query. The TQL results are based on the attributes defined for the new TQL query. |
| Base the Enrichment rule on an existing TQL | Select this check box if you want to base the Enrichment rule on an existing TQL query. Select the required Enrichment TQL query from the drop-down list. |
| Base TQL Description | (Optional) Enter a description of the TQL query. |

| GUI Element (A-Z) | Description |
|--------------------------|---|
| Base TQL Name | Enter a unique name for the Enrichment TQL query. If you selected the Base the Enrichment rule on an existing TQL option, select the Enrichment TQL query on which you want to base the rule. |
| Base TQL Priority | Select a priority level for the new TQL query (Low and Medium). This setting determines how often the query is rerun automatically by the system to include updated information from the CMDB. |

Node/Relationship Definition Dialog Box

| | |
|------------------------------|--|
| Description | <p>Displays the attributes of the selected node/relationship. The key attributes and the required attributes of the selected node appear in bold.</p> <p>Use an Enrichment rule to update the value of CI attributes in the CMDB, or to add data to attributes that currently do not have values. You can use this option, for example, for adding a note simultaneously to all CI instances.</p> <p>To access: Right-click a node or relationship when in Enrichment mode (select Enrichment from the TQL/Enrichment list at the top of the Enrichment Manager window) and select Update Relationship/Node.</p> |
| Important Information | <p>You must fill in the value of the key attributes and the required attributes of the Enrichment node. The method you use to define these values determines the number of instances created.</p> <p>If you enter a dynamic value, you can create numerous instances. For example, entering the dynamic value of a <code>host_key</code> for the CIT Host or an IP address attribute for the CIT IP.</p> |
| Included in Tasks | “Define an Enrichment Rule – Scenario” on page 300 |

Attributes Area

The following elements are included (unlabeled GUI elements are shown in angle brackets>):

| GUI Element (A-Z) | Description |
|-------------------|---|
| Name | The attribute name. |
| Type | The field type of the selected attribute. |
| Value | <p>The value as defined in one of the following:</p> <ul style="list-style-type: none"> ▶ The Value box in the Set Attributes area. ▶ The combination of the values in the By Attribute boxes in the Set Attributes area. ▶ The Value column if you selected Simple in the Type column in the Node Definition - Advanced Attribute dialog box. ▶ The combination of the values in the Value column and the column to the right of the Value column if you selected By Attribute in the Type column in the Node Definition - Advanced Attribute dialog box. |

Set Attributes Area

The following elements are included (unlabeled GUI elements are shown in angle brackets>):







| GUI Element (A-Z) | Description |
|---|---|
|  | <p>(Appears only if you selected an attribute of the field type string.) Opens the Node Definition - Advanced Attribute dialog box.</p> <p>Define node and relationship attributes of the type string using simple or complex expressions. You can also create complex expressions using regular expression format.</p> |
| Advanced | <p>(Appears only if you selected an attribute of the field type string.) Displays the attribute value you defined in the Node Definition - Advanced Attribute dialog box.</p> |

| GUI Element (A-Z) | Description |
|---|--|
| By Attribute | <p>Define an attribute using attributes from other nodes in the TQL query.</p> <ul style="list-style-type: none"> ▶ In the box to the left, select the required node. ▶ In the box to the right, select the node's required attribute. <p>The attribute definition appears in the Value column in the Attributes area.</p> |
| RegExp Group | <p>(Appears only when you select an attribute of the field type string.) Enter the group number only if you are adding a regular expression using regular expression syntax. This is the part of the regular expression pattern to focus on when creating the attribute. A set of parentheses () constitutes a group.</p> |
| Regular Expression | <p>(Appears only when you select an attribute of the field type string.) Add a regular expression using regular expression syntax. Enter the regular expression pattern.</p> |
| Value (in the Set Attributes area) | <p>Define a constant value. Enter the required value in the Value box or select a value from the Value list.</p> <p>Note: The value definition appears in the Value column in the Attributes area.</p> |

Node Definition – Advanced Attribute Dialog Box

| | |
|--------------------------|---|
| Description | <p>Define node and relationship attributes of the type String using simple or complex expressions. You can also create complex expressions using regular expression format.</p> <p>To access:</p> <ol style="list-style-type: none"> 1 Select an attribute of the type string in the Node Definition dialog box. 2 Select Advanced and then click the Advanced button. |
| Included in Tasks | <p>“Define an Enrichment Rule – Scenario” on page 300</p> |

The following elements are included (unlabeled GUI elements are shown in angle brackets>):

| GUI Element (A-Z) | Description |
|---|---|
|  | Define an attribute value using simple or complex expressions. Creates a new entry in the Type column. Click the new entry and select either Simple or By Attribute . For details, see the description for the Type column below. |
|  | Delete an attribute value. |
|  | Move a selected row up. |
|  | Move a selected row down. |
| Advanced Value | (This list is only available if you select By Attribute in the Type column.) Click the entry inside the box and select the required attribute. |
| Concatenate | Use all the attribute values listed in this dialog box. |
| RegExp Group | (This list is only available if you select By Attribute in the Type column.) Click inside the RegExp Group column, click the  button, and enter the group number in the Value for RegExp Group dialog box that opens. This is the part of the regular expression pattern to focus on when creating the attribute. A set of parentheses () constitutes a group. |
| Regular Expression | (This list is only available if you select By Attribute in the Type column.) Click inside the Regular Expression column, click the  button, and enter the regular expression pattern in the Value for Regular Expression dialog box that opens. |

| GUI Element (A-Z) | Description |
|---------------------------------------|--|
| Type | <p>Click the entry inside the Type column and select one of the following options:</p> <ul style="list-style-type: none"> ▶ Simple. Define a constant value using a simple expression. ▶ By Attribute. Define an attribute using attributes from other nodes in the TQL. <p>Default is: Simple</p> |
| Use first attribute with value | <p>Use the first attribute value listed in this dialog box that is not empty.</p> |
| Value | <ul style="list-style-type: none"> ▶ If you select Simple in the Type column, click inside the Value column, click the  button, and enter the required value in the Value for Simple dialog box. ▶ If you select By Attribute in the Type column, click inside the Value column and select the required value from the list. |

10

Topology Query Language

This chapter provides information on Topology Query Language (TQL).

This chapter includes:

Concepts

- ▶ Topology Query Language (TQL) Overview on page 324
- ▶ Topology Query Language on page 324
- ▶ The Roles of TQL on page 325
- ▶ Where TQL Queries Are Created on page 325
- ▶ Viewing TQL Query Results on page 326
- ▶ Compound Relationship on page 326
- ▶ Join Relationship on page 327
- ▶ Subgraph Definition on page 328

Tasks

- ▶ Define a TQL Query on page 328
- ▶ Add Nodes and Relationships to a TQL Query on page 330
- ▶ Add Enrichment Nodes and Relationships to an Enrichment TQL Query on page 331
- ▶ Define a Compound Relationship — Scenario on page 332
- ▶ Define a Join Relationship — Scenario on page 335
- ▶ Create a Subgraph Definition — Scenario on page 337

Reference

- ▶ Context Menu Options on page 339

- ▶ Attribute Operator Definitions on page 346
- ▶ TQL Logs on page 348
- ▶ Topology Query Language User Interface on page 352
- ▶ **Troubleshooting and Limitations** on page 401

Topology Query Language (TQL) Overview

Topology Query Language (TQL) is a language and tool for discovering, organizing, and managing IT infrastructure data. It enables you to create TQL queries that retrieve business service data from the configuration management database (CMDB) and displays the data in a visual representation that facilitates data monitoring and managing. For details on CMDB, see “Configuration Management Database (CMDB)” on page 19.

Topology Query Language

TQL extends the standard SQL language by adding two important capabilities:

- ▶ TQL enables you to draw conceptual relationships between configuration items (CIs), which represent their actual interdependencies. Using predefined operators, the different types of interconnections (relationships) that exist between CIs can be established, and consequently the infrastructure design and performance are more accurately represented. This representation serves as a basis and a model for the discovery, arrangement, query, and management of complex infrastructures.
- ▶ TQL includes a graphical aspect, consisting of visual symbols and syntax, that represents the resources and their interconnections. This visualization of an IT infrastructure simplifies the understanding, monitoring, and managing of the IT business operations.

The Roles of TQL

TQL plays several roles:

- ▶ Builds a business service model that defines and delineates the interconnection between IT assets that function together as business services. The business service model guides the discovery and identification of these business services, from the ever-increasing number and complexity of infrastructure resources. After the resources that comprise the business services are discovered, the business service model structures the way they are organized and managed in the CMDB.
- ▶ Constantly searches the CMDB for changes that occur in the state of managed resources. When such changes are detected, the relevant subsystems are informed and updated.
- ▶ Creates queries that retrieve business service data from the CMDB, and displays the data in a visual representation that facilitates data monitoring and managing.

Where TQL Queries Are Created

The following managers use TQL:

- ▶ **Correlation Manager.** Create a Correlation TQL query to simulate how infrastructure changes can impact your system. A Correlation rule is based on either a Correlation TQL query created from within the Correlation Manager, or on an existing query. By creating Correlation rules based on TQL queries, you can determine the true origin of a problem and its business impact. For details, see “Correlation Manager” on page 177.
- ▶ **Enrichment Manager.** Create an Enrichment rule based on either an Enrichment TQL query from within the Enrichment Manager, or on an existing query. An Enrichment rule enables you to either enlarge the CMDB, delete CI instances from the CMDB, or update the attributes of a CI that already exists in the CMDB. For details, see “Enrichment Manager” on page 297.
- ▶ **Query Manager.** Create TQL queries that can be used in other managers. For details, see “Query Manager” on page 283.

- ▶ **Topology Report Manager.** Create a report definition based on either a Report TQL query from within the Topology Report Manager, or on an existing query. You can define exactly which information appears in each report, including the order in which nodes are listed and their placement relative to other nodes, and how the information within each Report is sorted. For details, see “Topology Report Manager” on page 245.
- ▶ **View Manager.** Create a pattern view, template, or perspective based on a TQL query, or create a template based view using an existing template. For details, see “View Manager” on page 129.

Viewing TQL Query Results

You view the resulting data in a visual representation in the Topology View application. The queries define the structure of the resulting topology view. The view displays only those CIs and relationships that meet the query definition. For more details about Topology View application, see “Topology View Application” on page 515.

Compound Relationship

A compound relationship represents a path in the topological graph. You use a compound relationship to define the allowed steps in the path between the source and the target CIs.

Each row represents one of the allowed steps in the path leading from the source CI to the target CI in the topology map.

| Source | Relationship | Target |
|---------|--------------|--------|
| Host | Contained | IP |
| Network | Member | Host |

For an example of a compound definition, see “Define a Compound Relationship — Scenario” on page 332. For details on defining compound relationships, see “Add/Edit Compound Relationship Dialog Box” on page 355.

Join Relationship

A join relationship is a logical connection, which appears only in the topology view containing the TQL query results, and represents the relationship between two CIs. It does not exist in the CMDB. A join relationship is created by defining an attribute for each node, whose values are used for comparison.

The TQL results retrieve all CIs whose attribute values meet the conditions defined in the join definition.

For example, you can create a join definition that links all **Host** CIs connected to **IP** CIs whose **Created by** attribute values are equal (see the example below).

| Host | Operator | IP |
|------------|----------|------------|
| Created By | Equal | Created By |

Each join definition represents one condition defined for the join relationship.

Note: You can define multiple conditions.

For an example of a join definition, see “Define a Join Relationship — Scenario” on page 335. For details on defining join relationships, see “Add/Edit Join Relationship Dialog Box” on page 359.

Subgraph Definition

A subgraph definition enables you to create a graph that represents additional TQL query data related to a specific CI. The DDM job searches for the results from both the TQL query and the subgraph definitions. The query recursively retrieves all the related CIs by a defined depth. For details on defining subgraph definitions, see “Subgraph Definition Dialog Box” on page 390.

In the graph, you can define the relationship that is connected to a specific node. For example, if one of the nodes is a host, you can specify different relationships for Windows, router, and IP. You can also define attribute conditions for nodes. For details, see “Subgraph Condition Definition Dialog Box” on page 388.

The DDM job retrieves data that meets the criteria that is defined in the subgraph.

For an example of a subgraph definition, see “Create a Subgraph Definition — Scenario” on page 337.

Define a TQL Query

This task describes how to create a TQL query in Correlation Manager, Query Manager, View Manager, Topology Report Manager, and Enrichment Manager.

This task includes the following steps:

- “Create a TQL Query” on page 328
- “Add Nodes and Relationships to the Query” on page 329

1 Create a TQL Query

Create a new query by giving the query a unique name in the relevant manager. For details about the managers in which you can create a TQL query, see “Where TQL Queries Are Created” on page 325. In this task, you create a TQL query in the Query Manager. For details, see “New Query/Save Query As/Query Properties Dialog Box” on page 285.

2 Add Nodes and Relationships to the Query

Add the TQL nodes and relationships that define the query. The TQL nodes represent the CITs, as defined in the CI Type Manager, and the relationships represent the connections between them. Relationships are defined one at a time for each pair of TQL nodes in the query. For details, see “Add Nodes and Relationships to a TQL Query” on page 330. For details on the CI Type Manager, see “CI Type Manager” on page 205.

Example of a TQL Query Definition

The direction of the relationship indicates which node is dependent on the other. The following example displays two hosts, a Server Port, and a Client Port, which are linked to one another via a client/server connection. The TQL results must comply with the direction of the arrows.

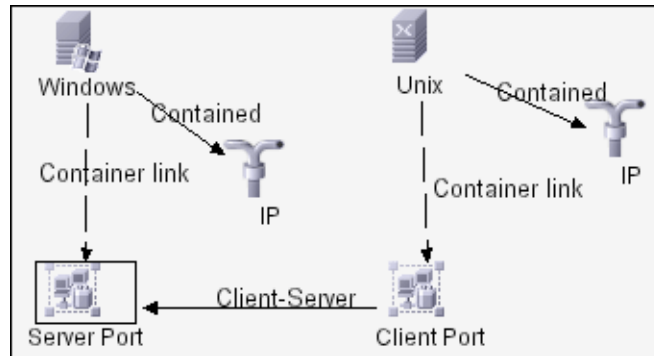

Note: A TQL query is subject to certain validation restrictions. For details, see “Troubleshooting and Limitations” on page 401.

Add Nodes and Relationships to a TQL Query

This section explains how to add nodes and relationships to a TQL query. It is relevant for View Manager, Query Manager, Correlation Manager, Enrichment Manager, and Topology Report Manager.

Note: For TQL queries to be valid, they must comply with certain restrictions. For details, see “Troubleshooting and Limitations” on page 401.

To add nodes and relationships to a TQL query:

-  **1** From the tree in the left pane, select the required query or click the **New** button to create one.
- 2** From the tree displayed in the CI Type Selector, click and drag one or more required TQL nodes on to the editing pane. These are the TQL nodes that are included in the query.
- 3** To add a relationship between two nodes:
 - Select the required TQL nodes by holding down CTRL and clicking the TQL nodes, right-click and select **Add Relationship**.

or



- Click the **Create Relationship** icon and draw a line between the required nodes.

The Select Relationship Type dialog box opens. Select the required relationship type. For details, see “Select Relationship Type Dialog Box” on page 387.

- 4** Click **OK**. The selected nodes are linked by the relationship you have selected.

Add Enrichment Nodes and Relationships to an Enrichment TQL Query

This section describes how to add Enrichment nodes and relationships to an Enrichment TQL query in the Enrichment Manager. For more information on Enrichment Manager, see “Enrichment Manager” on page 297.

To add Enrichment nodes and relationships to a TQL query:

- 1** From the tree in the Enrichment Rules pane, select the Enrichment rule to which you want to add Enrichment nodes and relationships or create a new one. For details, see “New Enrichment Rule/Enrichment Rule Properties/Save As Enrichment Rule Wizard” on page 314.
- 2** From the **TQL/Enrichment** list at the top of the Enrichment Manager window, select **Enrichment** mode.

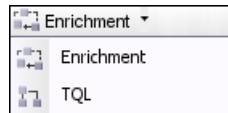

- 3** From the tree displayed in the CI Type Selector, click and drag the nodes you want to function as an Enrichment node on to the editing pane. These are the TQL nodes that are included in the query. Added Enrichment nodes are displayed by an added indicator.



Note: You can add more than one Enrichment node to a rule.

- 4** The next step is to link the Enrichment node to an existing TQL node or nodes, to provide the Enrichment node with the needed context for its operation.

Following are the Enrichment rule validations:

- ▶ You must link the new Enrichment node to at least one of the existing TQL nodes in the rule.
- ▶ Enrichment nodes can only be linked to one another with an Enrichment relationship.

- ▶ If the new Enrichment node must be contained (according to its CIT definition) in another node, you must use the **Container link** relationship to connect this Enrichment node to an existing TQL node.
- ▶ You cannot link an Enrichment node to a TQL node that is not visible.

5 To add a relationship between two nodes:

- ▶ Select the required nodes by holding down CTRL and clicking the TQL nodes, right-click and select **Add Relationship**.

or



- ▶ Click the **Create Relationship** icon and draw a line between the required nodes.

Added Enrichment relationships are displayed by an added indicator.

The Add Relationship dialog box opens. For details, see “Add/Edit Relationship Dialog Box” on page 362.

6 Click **OK**. The selected nodes are linked by the relationship you have selected.

Define a Compound Relationship — Scenario

This section describes how to define the allowed steps that form a compound relationship between a **Network** and an **IP** CI.

Note: To reach the required result, you must implement each one of the following steps.

To define a compound relationship between a Network CI and an IP CI:

- 1** Create a TQL query and drag the following nodes from the CI Type Selector onto the editing pane:
 - ▶ Network
 - ▶ IP

- 2 Right-click the **Network** and **IP** nodes and select **Add Compound Relationship** to open the Add Compound Relationship dialog box.
- + 3 Click the **Add** button to open the Add Triplet dialog box and do the following.
 - From the **Source** list, select **Network**.
 - From the **Target** list, select **Host**.
 - From the **Relationship** list, select **Member**.
 - Select the required **Relationship** direction.
- 4 Click **OK** to save your changes.
- + 5 Click the **Add** button to open the Add Triplet dialog box and do the following:
 - From the **Source** list, select **Host**.
 - From the **Target** list, select **IP**.
 - From the **Relationship** list, select **Contained**.
 - Select the required **Relationship** direction.
- 6 Click **OK** to save your changes.

The compound definitions now look like this.

| Source | Relationship | Target |
|---------|--------------|--------|
| Network | Member | Host |
| Host | Contained | IP |

- 7 Click **OK** to save your changes.

The TQL query in the editing pane now looks like this:

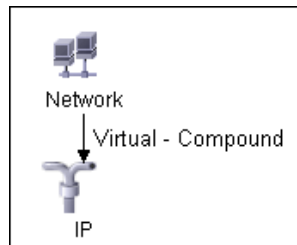

- 8 Go to the required view in IT Universe to view the results. If you did not select the **Show full path between source and target CIs** option, then the results display the names of the relationships that link the CIs as **Virtual-Compound** rather than the actual names of the relationships. See the illustration below:

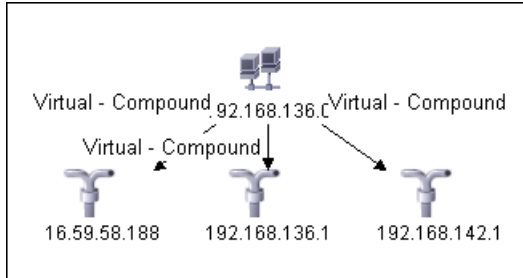

You can double-click the **Virtual - Compound** relationship in IT Universe to open the Link Map, which displays the CIs and relationships that comprise the allowed steps used to link the **Network** and **IP** CIs.

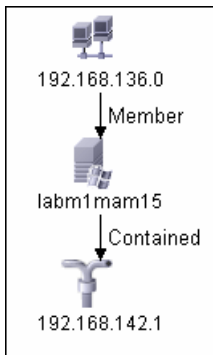

In the example above, the **192.168.136.0** (Network) CI is linked to the **192.168.142.1** (IP) CI through the **labm1mam15** (Host) CI.

If you did select the **Show full path between source and target CIs** option, then the results in IT Universe display the actual names of the relationships that link the CIs and the full path between the source and target CIs. See the illustration below:

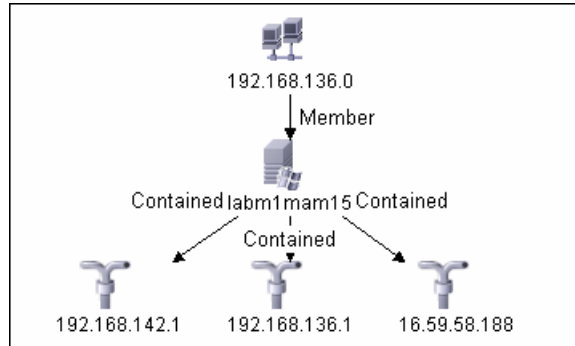

Define a Join Relationship — Scenario

This section explains how to define a join relationship that links **Host** CIs to **IP** CIs whose **Created by** attribute values are equal.

Note: To reach the required result, you must implement each one of the following steps.

To define a join relationship that links all IP and Host CIs whose Created by attribute values are equal:

- 1** Create a TQL query and drag the following nodes from the CI Type Selector onto the editing pane:
 - Host
 - IP
- 2** Select the **Host** and **IP** nodes and right-click to open the Add Join Relationship dialog box.



- 3 Click the **Add** button to open the Join Relationship Condition dialog box and do the following:
 - In the **Host Attribute** box, select **Created by**.
 - In the **Operator** box, select **Equal**.
 - In the **IP Attribute** box, select **Created by**.
- 4 Click **OK** to save your changes.

The Join Definition area now looks like this.

| Host | Operator | IP |
|------------|----------|------------|
| Created By | Equal | Created By |

- 5 Click **OK** to save your changes.

The TQL query in the editing pane now looks like this:

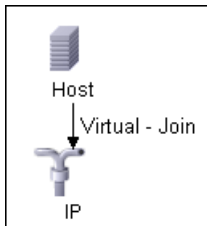

Go to the required view in IT Universe to view the results. Double-click the **Virtual - Join** relationship in IT Universe to open the Link Map (as seen below), which displays all the **Host** CIs that are connected to an **IP** CI whose **Created by** attribute values are equal.

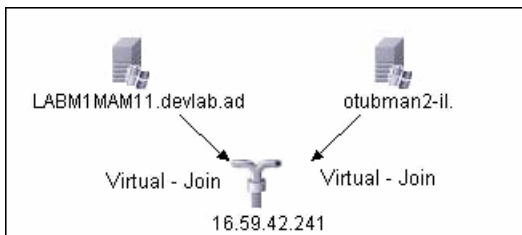



Create a Subgraph Definition — Scenario

This section describes how to create a subgraph definition. In this example, the TQL query results retrieve all CIs that are connected to a host whose host's display label is <host display label> by either a **Container link** or a **Contained** relationship.

Note: To reach the required result, you must implement each one of the following steps.

To create this sample subgraph definition:

- 1** Create a TQL query and drag a **Host** node from the CI Type Selector onto the editing pane.
- 2** Right-click the **Host** node and select **Subgraph Definition** to open the Subgraph Definition dialog box.
- 3** Select the default subgraph definition that appears and delete it.
-  **4** Click the **Add** button to open the Add Triplet dialog box and do the following:
 - From the **Source** list, select **IT Universe**.
 - From the **Target** list, select **IT Universe**.
 - From the **Relationship** list, select **Contained**.
- 5** Click **OK** to save your changes.
-  **6** Click the **Add** button to open the Add Triplet dialog box and do the following:
 - From the **Source** list, select **IT Universe**.
 - From the **Target** list, select **IT Universe**.
 - From the **Relationship** list, select **Container link**.
- 7** Click **OK** to save your changes.



- 8 Click the **Add** button to open the Add Triplet dialog box and do the following:
 - From the **Source** list, select **IT Universe**.
 - From the **Target** list, select **IT Universe**.
 - From the **Relationship** list, select **Contains**.
- 9 Click **OK** to save your changes.

The Add Triplet dialog box now looks like this.

| Source | Relationship | Target |
|-------------|----------------|-------------|
| IT Universe | Contained | IT Universe |
| IT Universe | Container link | IT Universe |
| IT Universe | Contains | IT Universe |

- 10 Click **OK** in the Subgraph Definition dialog box.
- 11 Right-click the **Host** node and select **Node Properties** to open the Node Properties dialog box.
- 12 Click the **Attribute** tab.
- 13 From the **Attribute Name** list, select **Display Label**.
- 14 From the **Operator** list, select **Equal**.
- 15 Select **Fixed Value**.
- 16 In the **Value** box, enter <host display label>.
- 17 Click **OK** to save your changes.

The Attribute tab now looks like this.

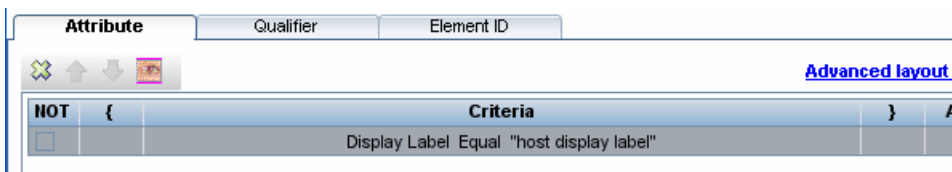

Go to the required view in IT Universe to view the results.

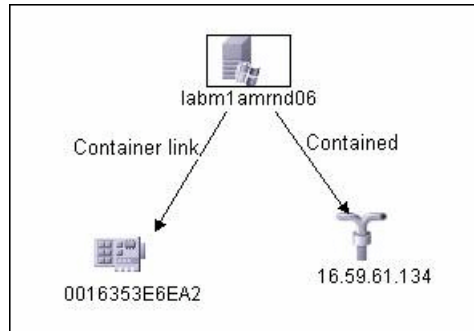

The results show that the **labm1amrnd06** (Host) CI is linked to the **16.59.61.134** (IP) CI by the **Contained** relationship and to the **0016353E6EA2** (Interface) CI by the **Container link** relationship.

Context Menu Options

This section includes a list of TQL context menu options (listed alphabetically):

| GUI Element (A–Z) | Description |
|------------------------------------|---|
| Add Calculated Relationship | <p>Enables you to create a calculated relationship.</p> <ul style="list-style-type: none"> ▶ For details on how to create a calculated relationship, see “Triplets Page” on page 232. ▶ For details about Impact Modeling, see “Using Calculated Relationships” on page 407 |
| Add Compound Relationship | <p>Enables you to define the connection between two nodes using a compound relationship.</p> <p>For details, see “Add/Edit Compound Relationship Dialog Box” on page 355.</p> |

| GUI Element (A–Z) | Description |
|------------------------------|--|
| Add Join Relationship | <p>Enables you to define join relationships, which is created by defining an attribute for each node, whose values are used for comparison.</p> <p>For details, see “Add/Edit Join Relationship Dialog Box” on page 359.</p> |
| Add Relationship | <p>Enables you to create a relationship for your nodes by selecting it from a predefined list. Displays the Add Relationship dialog box.</p> <p>For details, see “Add/Edit Relationship Dialog Box” on page 362.</p> <p>Note: In Enrichment Manager, this option adds an Enrichment relationship to the rule when working in Enrichment mode. Applicable for regular and Enrichment nodes. For details, see “Enrichment Manager” on page 297. Added relationships are denoted by an added  indicator.</p> |

| GUI Element (A–Z) | Description |
|----------------------------|---|
| Add Rule | <p>Enables you to add folding rules to a relationship. Right-click the relationship for which you want to define a folding rule. Select one of the following options to define the organizational structure between the two CI types connected by the selected relationship:</p> <ul style="list-style-type: none"> ▶ Parent. Select this option to display Node1 as the parent of Node2. That is, double-clicking the Node1 element on one map level displays a new map level with Node2 elements. ▶ Right Sibling. Select this option to display Node1 elements wherever Node2 elements are displayed. That is, both CIs are displayed on the same map level. ▶ Left Sibling. Select this option to display Node2 elements wherever Node1 elements are displayed. That is, both CIs are displayed on the same map level. ▶ Child. Select this option to display Node1 as the child of Node2. That is, double-clicking a Node2 element on one map level displays a new map level with Node1 elements. ▶ None. Do not define any folding rules for this relationship. <p>Note: Only relevant for View Manager.</p> |
| Add to Applications | <p>Click to create an application CI and link it to all CIs of the type selected. For details, see “Link Nodes to Application CI” on page 134.</p> <p>Note: Only relevant for View Manager.</p> |
| Clear | <p>Available by right-clicking a node or relationship when working in Enrichment mode in the Enrichment Manager. Clears the node/relationship’s Enrichment rule definition. For details, see “Enrichment Manager” on page 297.</p> <p>Appears only if you have updated or deleted a node/relationship using an Enrichment rule.</p> <p>Note: Only relevant for Enrichment Manager.</p> |

| GUI Element (A–Z) | Description |
|------------------------------|--|
| Clear Contact Node | <p>Changes the selected node from a contact node to a regular node.</p> <p>Note: Only relevant for perspectives in View Manager.</p> |
| Clear Node Definition | <p>Deletes the report definition for the selected Report node. For details, see “Topology Report Manager” on page 245.</p> <p>Note: Only relevant for Topology Report Manager.</p> |
| Copy/Paste | <p>Copy/paste an existing TQL node/relationship in the same query or into another TQL query.</p> <p>The copied TQL node/relationship includes all TQL definitions.</p> <p>You can copy and paste relationships provided that the TQL nodes to which the relationships are connected are also selected. A relationship on its own cannot be copied without its connecting TQL nodes.</p> <p>You can select multiple TQL nodes/relationships as well.</p> <p>Note: The Paste option is available only after using the Copy option to copy an existing TQL node/relationship.</p> |
| Define Affected | <p>Define which node in the TQL query is the trigger Correlation node and which nodes are affected by the changes that occur in the system. For details, see “Affected Nodes Dialog Box” on page 186.</p> <p>Note: Only relevant for Correlation Manager.</p> |
| Delete | <p>Deletes the selected node/relationship/CI.</p> <p>Note: This option is not available for calculated relationships.</p> |

| GUI Element (A–Z) | Description |
|-------------------------------------|--|
| Delete Relationship/Node | <p>Available by right-clicking a node or relationship when working in Enrichment mode.</p> <p>Creates a specific Enrichment rule that is designed to delete CIs/relationships from the CMDB. Applicable to regular nodes and relationships only. You can use this option, for example, for removing unnecessary data from the CMDB. For details, see “Enrichment Manager” on page 297.</p> <p>Deleted nodes and relationships are denoted by a removed  indicator.</p> <p>Note: Only relevant for Enrichment Manager.</p> |
| Edit Relationship Type | <p>Displays the Edit Relationship Type dialog box. For details, see “Add/Edit Relationship Dialog Box” on page 362.</p> <p>Note: This option appears only when the selected relationship has descendants.</p> |
| Node Order | <p>Displays the Set Node Order dialog box, enabling you to determine the order in which Report node information is displayed in the report, that is, the order of the report’s columns. For details, see “Set Node Order Dialog Box” on page 279.</p> <p>Note: Only relevant for Topology Report Manager.</p> |
| Node/Relationship Definition | <p>Displays the Grouping dialog box which enables you to group CIs in the topology map. For details, see “Node/Relationship Grouping Dialog Box” on page 159.</p> <p>Note: Only relevant for View Manager.</p> |
| Node/Relationship Properties | <p>Displays the Node/Relationship Properties dialog box, enabling you to define the attribute conditions for the selected TQL node/relationship. For details, see “Node/Relationship Properties Dialog Box” on page 375.</p> <p>Note: This option is not available for calculated relationships.</p> |

| GUI Element (A–Z) | Description |
|---------------------------------|--|
| Refine Node Type | <p>Displays the Refine Node Type dialog box. Enables you to change the CI type of the node after you have created it. For details, see “Refine Node Type Dialog Box” on page 386.</p> <p>Note: This option only appears if a child of the CI type exists.</p> |
| Remove from Applications | <p>Click to remove a business service item from a business service view. For details, see “Link Nodes to Application CI” on page 134.</p> <p>Note: Only relevant for View Manager.</p> |
| Remove Subgraph | <p>Only appears if you have defined a subgraph definition. For details, see “Subgraph Definition Dialog Box” on page 390.</p> |
| Report Node Definition | <p>Displays the Report Node Definition dialog box, enabling you to determine the content of the report. For details, see “Report Node Definition Dialog Box” on page 276.</p> <p>Note: Only relevant for Topology Report Manager.</p> |
| Reset Affected | <p>Removes the Define Affected definition applied to that node. For details on the Define Affected definition, see “Affected Nodes Dialog Box” on page 186.</p> <p>Note: Only relevant for Correlation Manager.</p> |
| Reset Inner Relationship | <p>Redraws a self-referential relationship in the Topology map as a square for ease of viewing.</p> <p>Note: Only relevant for self-referential relationships which are not square.</p> |
| Set As Contact Node | <p>Designates the selected node as a contact node for the perspective.</p> <p>Note: Only relevant for perspectives in View Manager.</p> |

| GUI Element (A–Z) | Description |
|------------------------------------|---|
| Set View Element Parameters | <p>Appears only when a parameterized condition is defined for the selected CI.</p> <p>Displays the Set View Element Parameters dialog box where you can edit the parameter of each condition. For details, see “Set View Parameters/Set View Element Parameters Dialog Box” on page 163.</p> <p>Note: Only relevant for View Manager and Topology Report.</p> |
| Show Element’s instances | <p>Displays the Element Instances dialog box which displays all the instances found for each node in a table. For details, see “Element Instances Dialog Box” on page 368.</p> |
| Straighten | <p>Straightens the relationship between two nodes. This option is only available for relationships that have angles.</p> |
| Subgraph Definition | <p>Displays the Subgraph Definition dialog box, where you can create a graph that represents additional TQL query data related to a specific node. For details, see “Subgraph Definition Dialog Box” on page 390.</p> |
| TQL Node Wizard | <p>Displays the TQL Node Wizard dialog box which enables you to build a TQL query. For details, see “TQL Node Wizard” on page 392.</p> |
| Update Relationship/Node | <p>Use an Enrichment rule to update the value of CI attributes in the CMDB, or to add data to attributes that currently do not have values. Opens the Node Definition - Attributes dialog box. For details, see “Node/Relationship Definition Dialog Box” on page 318. This is applicable for both regular and Enrichment nodes. Updated nodes are denoted by an updated  indicator.</p> <p>Note: Only relevant for Enrichment Manager.</p> |

Attribute Operator Definitions

This section contains a list of operators used to define attribute conditions in various dialog boxes, such as the Subgraph Condition dialog box, the Add Relationship dialog box, Correlation Definition dialog box, or the Node/Relationship Properties dialog box.

| Operator | Description |
|------------------------------|--|
| Changed during | (Displayed only when you select the Create Time attribute.) Displays only the instances that changed during the period specified in the Value comparison box. |
| Equal | Checks whether the attribute value is equal to the value specified in the Value Comparison box. |
| Equal ignore case | Checks whether the attribute value is equal to the value specified in the value box regardless of the case. |
| Greater than or equal | Checks whether the attribute value is greater than or equal to the value specified in the Value comparison box. |
| Greater | Checks whether the attribute value is greater than the value specified in the Value comparison box. |
| In | Displays only the instances where this attribute value equals one of the selected values. For example, for CIs that have a Change state that equals Plan and New , select the operator In from the Operator list and select both Plan and New from the Value box. |
| In list | Equals one of the elements that appears in the list. For example: 320,4445,3483. |
| Is null | Checks whether the attribute value is null. |
| Less | Checks whether the attribute value is less than the value specified in the Value comparison box. |

| Operator | Description |
|---------------------------|---|
| Less than or equal | Checks whether the attribute value is less than or equal to the value specified in the Value comparison box. |
| Like | Uses a wildcard (%). Use Like when you are not sure of the complete name for which you are searching. |
| Like ignore case | Uses a wildcard (%). Use Like ignore case when you are not sure of the complete name for which you are searching. The case of the string is ignored. |
| Not equal | Checks whether the attribute value is not equal to the value specified in the Value Comparison box. |
| Unchanged during | (Displayed when you select a date type attribute.) Displays only the instances that did not change during the period specified in the Value comparison box. |

Note:

- For **Not equal** or **Not like** operators, query results do not include data from the CI instances that are not assigned a value. For example, a system contains three hosts: Host1 is assigned the value A, Host2 is assigned the value B, and Host3 is not assigned a value. If you create a query to retrieve all hosts that are **Not equal** to A, the results of your query include Host2 only, because Host3 is not assigned a value.
 - HP Universal CMDB supports both Microsoft SQL Server and Oracle Server servers. Microsoft SQL Server is not case sensitive by default (unlike Oracle Server which is case sensitive). Consequently, if you are using Microsoft SQL Server, the **Equal** operator retrieves the same query results as the **Equal ignore case** operator. For example, if you select the attribute **City**, the operator **Equal**, and type **NEW YORK** in the **Value comparison** box, case differences are ignored and query results include **NEW YORK**, **New York** and **new york**.
-

TQL Logs

This section contains definitions for TQL parameter log files.

This section includes the following topics:

- “Pattern Log” on page 348
- “Pattern Statistics Log” on page 349
- “Audit Short/Detailed Log (TQL Perspective)” on page 350
- “Incremental Statistics Log” on page 350
- “Incremental Splitter Log” on page 351
- “Incremental Detailed Log” on page 352

Pattern Log

The log name is **cmdb.pattern.log**.

| Log File | Description |
|-------------------|--|
| Purpose | Information about the lifecycle of a TQL query that is handled and calculated in the CMDB. Only TQLs stored in the CMDB are included. Information about ad hoc TQLs is not included. |
| Information Level | Not available. |
| Error Level | Not available. |
| Debug Level | Possible actions performed on each TQL query include: <ul style="list-style-type: none"> ➤ status changes ➤ model changes ➤ query changes ➤ completed calculations |

| Log File | Description |
|-----------------------|--|
| Basic Troubleshooting | <p>Check if a TQL query has the same status for a long time:</p> <ul style="list-style-type: none"> ▶ new – the query is in lazy loading ▶ inactive ▶ calculation – the calculation may have failed but the scheduler was not informed <p>You can also view the number of notifications that a TQL received.</p> |

Pattern Statistics Log

The log name is `cmdb.pattern.statistics.log`.

| Log File | Description |
|-----------------------|---|
| Purpose | General calculation data for each TQL, updated at predefined intervals. |
| Information Level | <p>The following information is given for each TQL:</p> <ul style="list-style-type: none"> ▶ name ▶ average, minimum, and maximum calculation times ▶ number of calculations ▶ last calculation time ▶ result size |
| Error Level | Not available. |
| Debug Level | Not available. |
| Basic Troubleshooting | <ul style="list-style-type: none"> ▶ Verify that a specific TQL was updated. ▶ Evaluate a TQL's calculation time. ▶ Evaluate a TQL's result size. |

Audit Short/Detailed Log (TQL Perspective)

The log name is `cmdb.audit.short.log`.

| Log File | Description |
|-----------------------|---|
| Purpose | CMDB state changes, CI Type changes, and TQL results. You can use this log to follow the results of TQL queries. |
| Information Level | Not available. |
| Error Level | Not available. |
| Debug Level | <ul style="list-style-type: none"> ▶ Final calculation for TQLs is logged. ▶ If the final TQL calculation is unchanged from the previous calculation, this is noted. ▶ If the final TQL calculation is changed from the previous calculation, results of the CIs and relationships are recorded in the detailed log. The number of CIs and relationships are recorded in the short log. |
| Basic Troubleshooting | <ul style="list-style-type: none"> ▶ Use this log to verify which notifications are published by the TQL subsystem. ▶ Check the section at the end of each result. This section includes added, removed, and updated CIs and relationships. ▶ Track the CIT changes and see if the query results also change. You can thus correlate the CIT changes to the results of the query calculations. |

Incremental Statistics Log

The log name is `cmdb.incremental.statistics.log`.

| Log File | Description |
|-------------------|--|
| Purpose | Traces the calculation procedure, full or incremental, of every query. |
| Information Level | Not available. |

| Log File | Description |
|-----------------------|--|
| Error Level | Not available. |
| Debug Level | <ul style="list-style-type: none"> ▶ Gives the date, time, query name, and whether an incremental statistic calculation was performed (yes/no). ▶ If an incremental statistic calculation was not performed, states the reason, the number of subcalculations (relevant for incremental calculations only), and the complete calculation time. |
| Basic Troubleshooting | <p>Monitors the calculation process.</p> <p>If a specific query calculation takes a long time, check if it is a full or incremental calculation:</p> <ul style="list-style-type: none"> ▶ If full, check whether a full calculation is necessary. ▶ If incremental, check how many subcalculations have been performed. |

Incremental Splitter Log

The log name is **cmdb.incremental.splitter.log**.

| Log File | Description |
|-----------------------|--|
| Purpose | Monitors the incremental splitter result made during an incremental calculation. |
| Information Level | Not available. |
| Error Level | Not available. |
| Debug Level | Gives the set of node numbers of each query graph created by the incremental splitter. |
| Basic Troubleshooting | If the TQL result calculated by the incremental calculator is wrong, verify that the splitter result is correct. |

Incremental Detailed Log

The log name is `cmdb.incremental.detailed.log`.

| Log File | Description |
|-----------------------|---|
| Purpose | Monitors the incremental calculation process. |
| Information Level | Not available. |
| Error Level | Not available. |
| Debug Level | Each incremental subcalculation entry includes the following: <ul style="list-style-type: none"> ▶ the trigger node ▶ the number of elements classified to the trigger node ▶ whether the subcalculation step is driven by new elements added to the model or by existing elements ▶ the calculated query graph |
| Basic Troubleshooting | Follows the basic steps of an incremental calculation. |

Topology Query Language User Interface

This section describes:

- ▶ Add/Edit Calculated Relationship Dialog Box on page 353
- ▶ Add/Edit Compound Relationship Dialog Box on page 355
- ▶ Add/Edit Join Relationship Dialog Box on page 359
- ▶ Add/Edit Relationship Dialog Box on page 362
- ▶ Add Triplet Dialog Box on page 364
- ▶ Element Instances Dialog Box on page 368
- ▶ Filter CI Instances Dialog Box on page 371
- ▶ Join Relationship Condition Dialog Box on page 372
- ▶ Layout Settings Dialog Box on page 374

- Node/Relationship Properties Dialog Box on page 375
- Refine Node Type Dialog Box on page 386
- Select Relationship Type Dialog Box on page 387
- Subgraph Condition Definition Dialog Box on page 388
- Subgraph Definition Dialog Box on page 390
- TQL Node Wizard on page 392
- User Preferences Dialog Box on page 400

Add/Edit Calculated Relationship Dialog Box

| | |
|---------------------------|---|
| <p>Description</p> | <p>Enables you to define the connection between two nodes using a calculated relationship from the CI Type model.</p> <p>To access in Topology Report Manager, Enrichment Manager, Correlation Manager, Query Manager, and View Manager: Right-click the required node in the editing pane in Topology Report Manager, Enrichment Manager, Correlation Manager, Query Manager, View Manager and select Add Calculated Relationship.</p> <p>Note: If you are using Enrichment Manager, select TQL mode at the top of the editing pane to display the Add Relationship option.</p> <p>To access in Manage Discovery Resources in Discovery:</p> <ol style="list-style-type: none"> 1 Select a pattern in the Discovery Resources pane. 2 In the Pattern Signature tab, click the  Edit Input TQL button to the right of the Input TQL box to open the Input TQL Editor. 3 Right-click the required node and select Add Calculated Relationship. |
|---------------------------|---|

| | |
|--------------------------|---|
| Included in Tasks | <ul style="list-style-type: none"> ➤ “Define a Report Rule – Scenario” on page 246 ➤ “Define a Correlation Rule – Workflow” on page 179 ➤ “Define an Enrichment Rule – Scenario” on page 300 ➤ “Create a TQL Query” on page 285 ➤ “Create a Pattern View” on page 144 ➤ “Implement a Pattern” in <i>Discovery and Dependency Mapping Guide</i>. |
| Useful Links | <ul style="list-style-type: none"> ➤ “Using Calculated Relationships” on page 407 ➤ “CI Type Relationships” on page 208 |



The following elements are included (unlabeled GUI elements are shown in angle brackets):

| GUI Element (A-Z) | Description |
|------------------------------------|--|
| <List of calculated relationships> | Select the calculated relationship that defines the connection between two nodes. |
| Relationship Direction | The direction of the relationship that indicates which node is dependent on the other. |
| Relationship Name | The name of the calculated relationship. |
| Relationship Restrictions | <p>Select an option to define how to handle relationships between identical nodes or self relationships in the query results. A self relationship is a relationship that leads from a node to itself.</p> <p>Note: This list appears only when you select one node or two identical nodes.</p> <ul style="list-style-type: none"> ➤ Allow All Relationships. All relationships appear in the query results. ➤ Allow Self Relationships only. Only self-relationships (a relationship that leads to itself) appear in the query results. ➤ Allow Non Self Relationships only. Self-relationships do not appear in the query results. |

Add/Edit Compound Relationship Dialog Box

| | |
|-------------------------------------|--|
| <p>Description</p> | <p>Enables you to define the connection between two nodes using a compound relationship.</p> <p>To access in Topology Report Manager, Enrichment Manager, Correlation Manager, Query Manager, and View Manager:</p> <p>Right-click the required node in the editing pane in Topology Report Manager, Enrichment Manager, Correlation Manager, Query Manager, View Manager and select Add Compound Relationship.</p> <p>Note: If you are using Enrichment Manager, select TQL mode at the top of the editing pane to display the Add Relationship option.</p> <p>To access in Manage Discovery Resources in Discovery and Dependency Mapping (DDM):</p> <ol style="list-style-type: none"> 1 Select a pattern in the Discovery Resources pane. 2 In the Pattern Signature tab, click the  Edit Input TQL button to the right of the Input TQL box to open the Input TQL Editor. 3 Right-click the required node and select Add Compound Relationship. |
| <p>Important Information</p> | <p>You can create as many compound definitions as necessary.</p> |
| <p>Included in Tasks</p> | <ul style="list-style-type: none"> ➤ “Define a Report Rule – Scenario” on page 246 ➤ “Define a Correlation Rule – Workflow” on page 179 ➤ “Define an Enrichment Rule – Scenario” on page 300 ➤ “Create a TQL Query” on page 285 ➤ “Create a Pattern View” on page 144 ➤ “Implement a Pattern” in <i>Discovery and Dependency Mapping Guide</i>. |
| <p>Useful Links</p> | <ul style="list-style-type: none"> ➤ “Compound Relationship” on page 326 ➤ “Define a Compound Relationship — Scenario” on page 332 |

The following elements are included (unlabeled GUI elements are shown in angle brackets>):

| GUI Element (A-Z) | Description |
|---|--|
|  | Add a compound definition. Opens the Add Triplet dialog box. |
|  | Delete the selected compound definition. |
|  | Edit the selected compound definition. Opens the Add Triplet dialog box. |
| Max steps | The longest path allowed between the two CIs in the CMDB to be included in the discovery process. Default is: 5 |
| Min steps | The shortest path allowed between the two CIs in the CMDB to be included in the discovery process. Default is: 1 |
| Relationship | The relationship connecting the two nodes. |
| Relationship Direction | The direction of the relationship that indicates which node is dependent on the other. |
| Relationship Name | The name of the compound relationship. |
| Relationship Restrictions | Select an option to define how to handle relationships between identical nodes or self relationships in the query results. A self relationship is a relationship that leads from a node to itself. Note: This list appears only when you select one node or two identical nodes. <ul style="list-style-type: none"> ➤ Allow All Relationships. All relationships appear in the query results. ➤ Allow Self Relationships only. Only self-relationships (a relationship that leads to itself) appear in the query results. ➤ Allow Non Self Relationships only. Self-relationships do not appear in the query results. |

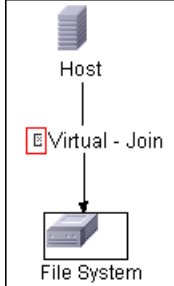

| GUI Element (A-Z) | Description |
|---|---|
| Show full path between source and target CIs | If you select this option, then the query results display the actual names of the relationships that link the CIs and the full path between the source and target CIs. |
| Source | The required source node. |
| Stop at first compound level | <p>Select this option if you want the system to stop looking for TQL results once it reaches the first target in the path.</p> <p>In the following sample compound link definition, Depth is defined as 10 and Stop at first compound level is selected.</p> <div data-bbox="622 583 1243 874" data-label="Diagram"> </div> <p>The TQL results include the Target 1, Target 3, and Target 4 because they are all at level 1 (the first CI found in the path). Target 2 is not included in the TQL results because it is at level 2 (the second CI found in the path).</p> |

| GUI Element (A-Z) | Description |
|-------------------|--|
| Target | The required target node. |
| Visible | <p>Select Visible to include query results relating to a join or compound relationship. By default, Visible is selected. When Visible is cleared, a box <input type="checkbox"/> appears to the left of the of the relationship's name in the editing pane, denoting that any query results pertaining to the relationship are not displayed in the topology map.</p>  |

 **Add/Edit Join Relationship Dialog Box**



| | |
|--------------------------|--|
| Description | <p>Enables you to define join relationships.</p> <p>To access in Topology Report Manager, Enrichment Manager, Correlation Manager, Query Manager, and View Manager:</p> <p>Right-click the required nodes in the editing pane in Topology Report Manager, Enrichment Manager, Correlation Manager, Query Manager, View Manager and select Add Join Relationship.</p> <p>Note: If you are using Enrichment Manager, select TQL mode at the top of the editing pane to display the Add Relationship option.</p> <p>To access in Manage Discovery Resources in Discovery:</p> <ol style="list-style-type: none"> 1 Select a pattern in the Discovery Resources pane. 2 In the Pattern Signature tab, click the  Edit Input TQL button to the right of the Input TQL box to open the Input TQL Editor. 3 Right-click the required node and select Add Join Relationship. |
| Included in Tasks | <ul style="list-style-type: none"> ➤ “Define a Report Rule – Scenario” on page 246 ➤ “Define a Correlation Rule – Workflow” on page 179 ➤ “Define an Enrichment Rule – Scenario” on page 300 ➤ “Create a TQL Query” on page 285 ➤ “Create a Pattern View” on page 144 ➤ “Implement a Pattern” in <i>Discovery and Dependency Mapping Guide</i>. |
| Useful Links | <p>“Join Relationship” on page 327</p> <p>“Define a Join Relationship — Scenario” on page 335</p> |

The following elements are included (unlabeled GUI elements are shown in angle brackets):

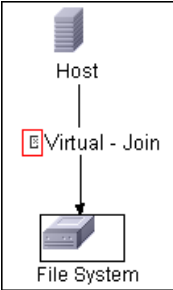
| GUI Element (A-Z) | Description |
|---|--|
|  | Define a join definition. Opens the Join Relationship Condition dialog box. |
|  | Delete the selected join definition. |
|  | Edit the join definition. Opens the Join Relationship Condition dialog box. |
| <Selected node1> | A selected node. The first attribute applies to <end_1>. |
| <Selected node2> | A selected node. The second attribute applies to <end_2>. |
| And | All join definitions are linked by the And operator. |
| Operator | The operator selected in the Join Relationship Condition dialog box. For details about operator definitions, see “Attribute Operator Definitions” on page 346. |
| Relationship Direction | The direction of the relationship that indicates which node is dependent on the other. |
| Relationship Name | The name of the join relationship. |

| GUI Element (A-Z) | Description |
|----------------------------------|---|
| Relationship Restrictions | <p>Select an option to define how to handle relationships between identical nodes or self relationships in the query results. A self relationship is a relationship that leads from a node to itself.</p> <p>Note: This list appears only when you select one node or two identical nodes.</p> <ul style="list-style-type: none"> ➤ Allow All Relationships. All relationships appear in the query results. ➤ Allow Self Relationships only. Only self-relationships (a relationship that leads to itself) appear in the query results. ➤ Allow Non Self Relationships only. Self-relationships do not appear in the query results. |
| Visible | <p>Select Visible to include query results relating to a join or compound relationship. By default, Visible is selected. When Visible is cleared, an invisible box <input type="checkbox"/> appears to the left of the of the relationship's name in the editing pane. Any query results pertaining to the relationship are not displayed in the topology map.</p> <div data-bbox="611 907 782 1197" style="border: 1px solid black; padding: 5px; margin: 10px 0;">  <pre> graph TD Host[Host] -- Virtual - Join --> FS[File System] </pre> <p>The diagram shows a vertical flow: a 'Host' node (represented by a server icon) at the top, connected by a downward arrow to a 'Virtual - Join' relationship (represented by a box with a red border and an unchecked checkbox to its left), which is then connected by another downward arrow to a 'File System' node (represented by a server icon) at the bottom.</p> </div> |



Add/Edit Relationship Dialog Box

| | |
|-------------------------------------|--|
| <p>Description</p> | <p>Enables you to define the connection between two nodes in a query.</p> <p>To access in Topology Report Manager, Enrichment Manager, Correlation Manager, Query Manager, and View Manager:</p> <ul style="list-style-type: none"> ➤ Right-click the required node in the editing pane in Topology Report Manager, Enrichment Manager, Correlation Manager, Query Manager, View Manager and select Add Relationship. or ➤ Click the Create Relationship  icon and draw a line between the required nodes. <p>Note: If you are using Enrichment Manager, select TQL mode at the top of the editing pane to display the Add Relationship option.</p> <p>To access in Manage Discovery Resources in Discovery:</p> <ol style="list-style-type: none"> 1 Select a pattern in the Discovery Resources pane. 2 In the Pattern Signature tab, click the  Edit Input TQL button to the right of the Input TQL box to open the Input TQL Editor. 3 Right-click the required node and select Add Relationship. |
| <p>Included in Tasks</p> | <ul style="list-style-type: none"> ➤ “Define a Report Rule – Scenario” on page 246 ➤ “Define a Correlation Rule – Workflow” on page 179 ➤ “Define an Enrichment Rule – Scenario” on page 300 ➤ “Create a TQL Query” on page 285 ➤ “Create a Pattern View” on page 144 ➤ “Implement a Pattern” in <i>Discovery and Dependency Mapping Guide</i>. |
| <p>Important Information</p> | <p>This option does not appear when two selected nodes (or a single selected node) do not have a valid relationship between them.</p> |

The following elements are included (unlabeled GUI elements are shown in angle brackets):

| GUI Element (A-Z) | Description |
|--|--|
| <List of relationships from which to choose> | Select the relationship that defines the connection between two nodes. |
| Relationship Direction | The direction of the relationship that indicates which node is dependent on the other. |
| Relationship Name | The name of the relationship. |
| Relationship Restrictions | <p>Select an option to define how to handle relationships between identical nodes or self relationships in the query results. A self relationship is a relationship that leads from a node to itself.</p> <p>Note: This list appears only when you select one node or two identical nodes.</p> <ul style="list-style-type: none"> ▶ Allow All Relationships. All relationships appear in the query results. ▶ Allow Self Relationships only. Only self-relationships (a relationship that leads to itself) appear in the query results. ▶ Allow Non Self Relationships only. Self-relationships do not appear in the query results. |

Add Triplet Dialog Box

| | |
|---------------------------------|---|
| <p>Description</p> | <p>Enables you to define the allowed steps in a path in the topology graph leading from the source CI to the target CI when creating a subgraph definition, a compound relationship, or a calculated relationship.</p> <p>Select the nodes and relationships to be included in the topology graph.</p> <p>To access:</p> <ul style="list-style-type: none"> ➤ In the Add Compound Relationship dialog box, click the Add  button. For details, see “Add/Edit Compound Relationship Dialog Box” on page 355. ➤ In the Subgraph Definition dialog box, click  Add. For details, see “Subgraph Definition Dialog Box” on page 390. ➤ In CI Type Manager, select Calculated Relationships from the drop-down list in the CI Types pane. In the main window, select the Triplets pane and then click  Add. |
| <p>Included in Tasks</p> | <ul style="list-style-type: none"> ➤ “Define a Report Rule – Scenario” on page 246 ➤ “Define a Correlation Rule – Workflow” on page 179 ➤ “Define an Enrichment Rule – Scenario” on page 300 ➤ “Create a TQL Query” on page 285 ➤ “Create a Pattern View” on page 144 ➤ “Implement a Pattern” in <i>Discovery and Dependency Mapping Guide</i>. |
| <p>Useful Links</p> | <ul style="list-style-type: none"> ➤ “Compound Relationship” on page 326 ➤ “Define a Compound Relationship — Scenario” on page 332 ➤ “Subgraph Definition” on page 328 |

The following elements are included (unlabeled GUI elements are shown in angle brackets>):

| GUI Element (A-Z) | Description |
|---|---|
|  | <p>Define attribute conditions for the source and target nodes you selected. Opens the Subgraph Condition Definition dialog box.</p> <p>The Condition button is enabled only after you select a node from the Source or Target lists.</p> <p>Note: You cannot define attribute conditions for the source and target nodes in the CI Type Manager.</p> |
| Relationship | <p>Select an available relationship connecting the two nodes. The list of available relationships appears only after defining both nodes.</p> |
| Relationship Direction | <p>Select the required direction. Setting different relationship directions can achieve different query results. For an example, see “Setting Different Relationship Directions for Compound Definitions” on page 366.</p> <p>Note: The Relationship list remains empty until you have selected a source and target.</p> |
| Source | <p>Select the required source node.</p> |
| Target | <p>Select the required target node.</p> |

Setting Different Relationship Directions for Compound Definitions

You can achieve different TQL results by setting different relationship directions. For example, in your business world, as illustrated below, you want to create a compound relationship that connects between a node of the CIT **a** and a node of the CIT **b**. Depth is defined at 5 (for details, see “Depth” on page 391).

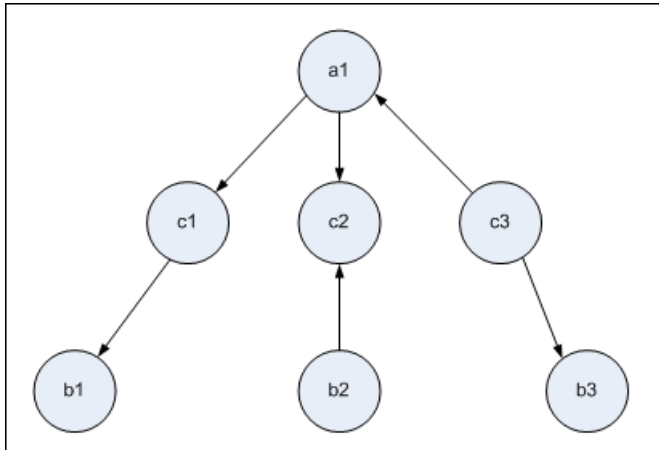

In the Add Triplet dialog box, you can create compound definitions to link nodes **a** and **b** using different relationship directions.

| Compound Definition | Source | Target | Relationship | Relationship Direction |
|---------------------|---------------|---------------|----------------|------------------------|
| #1 | node a | node c | <relationship> | source --> target |
| #2 | node c | node b | <relationship> | source --> target |
| #3 | node c | node b | <relationship> | source <-- target |

- Compound definitions 1 and 2 result in the following query:

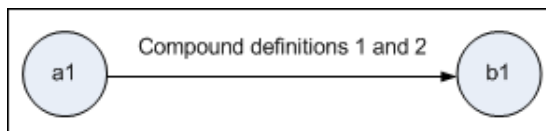

- Compound definitions 1 and 3 result in the following query:

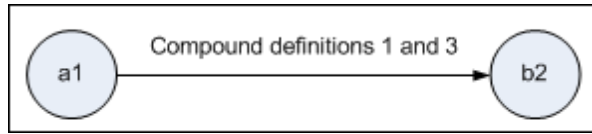



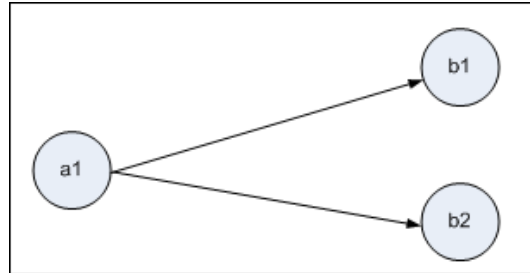



- Compound definitions 1, 2, and 3 result in the following query:





Element Instances Dialog Box

| | |
|-------------------------------------|---|
| <p>Description</p> | <p>Displays all of the CI instances found for the selected TQL node in a table.</p> <p>To access in Topology Report Manager, Enrichment Manager, Correlation Manager, Query Manager, and View Manager: In the editing pane, right-click the required node and select Show Element's Instances.</p> <p>Note: If you are using Enrichment Manager, select TQL mode at the top of the editing pane to display the Show Element's Instances option.</p> <p>To access in Manage Discovery Resources in Discovery:</p> <ol style="list-style-type: none"> 1 Select a pattern in the Discovery Resources pane. 2 In the Pattern Signature tab, click the  Edit Input TQL button to the right of the Input TQL box to open the Input TQL Editor. 3 Right-click the required node and select Show Element's Instances. |
| <p>Important Information</p> | <p>The columns in the report display the attributes of the selected CI type. The attributes displayed vary according to the CI type selected.</p> <p>By default, only columns corresponding to attributes that have been defined with the Asset Data, Change Monitored, and Comparable attribute qualifiers in the CIT Manager are displayed as columns in the dialog box. For details, see “Attributes Page” on page 228.</p> <p>If required, you can click the Display Hidden Columns button to display the attributes that are defined as Visible but not Static. For details on Static attributes, see “Attributes Page” on page 228.</p> |
| <p>Included in Tasks</p> | <ul style="list-style-type: none"> ➤ “Define a Report Rule – Scenario” on page 246 ➤ “Define a Correlation Rule – Workflow” on page 179 ➤ “Define an Enrichment Rule – Scenario” on page 300 ➤ “Create a TQL Query” on page 285 ➤ “Create a Pattern View” on page 144 |

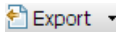

The following elements are included (unlabeled GUI elements are shown in angle brackets>):

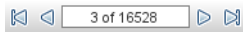
| GUI Element (A–Z) | Description |
|---|---|
|  | Specify the CIT you want displayed in the table. The table also includes the children of the selected CIT. |
|  | Click Show CI Properties to open the Configuration Item Properties dialog box for the selected CI. |
|  | Click to refresh the list of CI instances. |
|  | Filters the CI instances you want to display for the selected node. Opens the Filter CI Instances dialog box. |
|  | Clears the filter definitions you created in the Filter CI Instances dialog box. |
|  | Enables you to select the columns to be displayed. For details, see, “Select Columns Dialog Box” in <i>Reference Information</i> . |
|  | Enables you to set the order of the visible columns. For details, see, “Sort Column Content Dialog Box” in <i>Reference Information</i> . |

| GUI Element (A–Z) | Description |
|---|--|
|  | <p>Choose the export format for the table data. The available options are:</p> <ul style="list-style-type: none"> ➤ Excel. The table data is formatted as an .xls (Excel) file that can be displayed in a spreadsheet. ➤ PDF. The table data is exported in PDF format. ➤ RTF. The table data is exported in Rich Text Format. ➤ CSV. The table data is formatted as a comma-separated values (CSV) text file that can be displayed in a spreadsheet. <p>Note: For the CSV formatted table data to display correctly, the comma (,) must be defined as the list separator. In Windows, to verify or modify the list separator value, open Regional Options from the Control Panel, and on the Numbers tab ensure that the comma is defined as the List Separator value. In Solaris, you can specify the list separator in the application that opens the CSV file.</p> <ul style="list-style-type: none"> ➤ XML. The table data is formatted as an XML file that can be opened in a text or XML editor. <p>Tip: To extract HTML code from the report:</p> <ul style="list-style-type: none"> ➤ Save the file as HTML ➤ Open the file in an HTML editor ➤ Copy the relevant table into the target file <p>Note: This option is displayed in Text mode only.</p> |
|  | <p>Select the number of rows to be displayed.</p> |
|  | <p>Click to navigate through the results page by page or to jump to the first or last page.</p> |
| <p><Element Instances></p> | <p>The CI instances found for the selected TQL node. You can double-click an instance to open the Configuration Item Properties dialog box for that CI.</p> |
| <p><Element instances context (right-click) menu></p> | <p>For details, see “IT Universe Manager Context Menu” on page 71.</p> |

| GUI Element (A–Z) | Description |
|-------------------|--|
| <Toolbar> | For details, see “Toolbar Options” on page 717. |
| Display Label | The name of the CI instance as it appears in the topology map. |

Filter CI Instances Dialog Box

| | |
|---------------------------------|--|
| <p>Description</p> | <p>Enables you to reduce the number of CI instances to be displayed in a list by selecting a condition and a value for a specific CI.</p> <p>A description of the filter condition you defined appears above the table columns in the Element Instances dialog box. For example, the following illustration shows that a filter condition was created to display only CI instances whose CI type is Windows.</p>  <p>To access:</p> <ul style="list-style-type: none"> ▶ Click the Filter  button in the Element Instances dialog box. |
| <p>Included in Tasks</p> | <ul style="list-style-type: none"> ▶ “Define a Report Rule – Scenario” on page 246 ▶ “Define a Correlation Rule – Workflow” on page 179 ▶ “Define an Enrichment Rule – Scenario” on page 300 ▶ “Create a TQL Query” on page 285 ▶ “Create a Pattern View” on page 144 ▶ “Implement a Pattern” in <i>Discovery and Dependency Mapping Guide</i>. |

The following elements are included (unlabeled GUI elements are shown in angle brackets):

| GUI Element (A-Z) | Description |
|-------------------|--|
| Attribute | Displays all the attributes of the CI type to which the CI belongs. |
| Condition | Select the required operator. For details, see “Attribute Operator Definitions” on page 346. |
| Value | Select or enter the required value. |

Join Relationship Condition Dialog Box

| | |
|--------------------------|---|
| Description | <p>Enables you to define the connection between two nodes using a join relationship. The join definition appears in the Join Definition area.</p> <p>To access: Click the Add  button in the Add Join Relationship dialog box.</p> |
| Included in Tasks | <ul style="list-style-type: none"> ➤ “Define a Report Rule – Scenario” on page 246 ➤ “Define a Correlation Rule – Workflow” on page 179 ➤ “Define an Enrichment Rule – Scenario” on page 300 ➤ “Create a TQL Query” on page 285 ➤ “Create a Pattern View” on page 144 ➤ “Implement a Pattern” in <i>Discovery and Dependency Mapping Guide</i>. |

The following elements are included (unlabeled GUI elements are shown in angle brackets):

| GUI Element (A-Z) | Description |
|-------------------|--|
| <Selected node1> | A selected node. The first attribute applies to <end_1>. |

| GUI Element (A-Z) | Description |
|-------------------|---|
| <Selected node2> | A selected node. The second attribute applies to <end_2>. |
| Operator | <p>Select one of the following operators:</p> <ul style="list-style-type: none"> ▶ Equal. The system checks whether two selected attributes are equal. ▶ Not equal. The system checks whether two selected attributes are not equal. ▶ Sub string. The system checks whether the value of the first attribute is a substring of the value of the second attribute. ▶ Sub string ignore case. The system checks whether the value of the first attribute is a substring of the value of the second attribute regardless of the string's case. <p>Important: When using the operator Not equal, ensure that both sides of the join relationship have a limited result size. It is recommended to define more specific conditions so as not to overload the system with large results.</p> |

Layout Settings Dialog Box

| | |
|------------------------------|---|
| Description | <p>Enables you to determine which attributes are used in the calculation of the TQL query when using the UCMDB API. For details, see “The HP Universal CMDB Web Service API” in <i>Reference Information</i>.</p> <p>To access: Click Advanced layout settings in the Node/Relationship Properties dialog box.</p> |
| Important Information | <ul style="list-style-type: none"> ▶ Since this option is only relevant when querying the CMDB API, the query results in the user interface is not impacted by the attributes you select in this dialog box. ▶ Once you have selected the required attributes and clicked OK, you cannot clear the selections you have made. |
| Included in Tasks | <ul style="list-style-type: none"> ▶ “Define a Report Rule – Scenario” on page 246 ▶ “Define a Correlation Rule – Workflow” on page 179 ▶ “Define an Enrichment Rule – Scenario” on page 300 ▶ “Create a TQL Query” on page 285 ▶ “Create a Pattern View” on page 144 ▶ “Implement a Pattern” in <i>Discovery and Dependency Mapping Guide</i>. |

The following elements are included (unlabeled GUI elements are shown in angle brackets>):

| GUI Element (A-Z) | Description |
|--------------------------|--|
| Attribute name | The name of the attribute. |
| Calculate | Select this check box to include the attribute in the query’s calculation. |

Node/Relationship Properties Dialog Box

| | |
|---------------------------------|--|
| <p>Description</p> | <p>Enables you to define the attribute conditions for the selected TQL node/relationship.</p> <p>To access in Topology Report Manager, Enrichment Manager, Correlation Manager, Query Manager, and View Manager:</p> <p>In the editing pane, right-click the required node and select Node/Relationship Properties.</p> <p>Note: If you are using Enrichment Manager, select TQL mode at the top of the editing pane to display the Node Properties option.</p> <p>To access in Discovery:</p> <ol style="list-style-type: none"> 1 To access from the Discovery Resources pane, select a pattern. In the Pattern Signature tab, click the  Edit Input TQL button to the right of the Input TQL box to open the Input TQL Editor. 2 Right-click the required node/relationship and select Node/Relationship Properties. |
| <p>Included in Tasks</p> | <ul style="list-style-type: none"> ➤ “Define a Report Rule – Scenario” on page 246 ➤ “Define a Correlation Rule – Workflow” on page 179 ➤ “Define an Enrichment Rule – Scenario” on page 300 ➤ “Create a TQL Query” on page 285 ➤ “Create a Pattern View” on page 144 ➤ “Implement a Pattern” in <i>Discovery and Dependency Mapping Guide</i>. |





The following elements are included (unlabeled GUI elements are shown in angle brackets>):

| GUI Element (A-Z) | Description |
|---------------------------------|---|
| Advanced layout settings | <p>Enables you to determine which attributes are used in the calculation of the TQL query when querying the CMDB using third-party or custom tools.</p> <p>Opens the Layout Settings dialog box.</p> |
| Element name | <p>(Optional) The Element name box contains the name of the selected node/relationship. By default, the CI type is assigned as the element's name. You can rename a TQL node in the Element name box giving it a unique label. This can be helpful when there is more than one node of the same CI type in the TQL query.</p> |
| Include subtypes | <p>Select to display both the selected CI and its children in the topology map.</p> |
| Visible | <p>Select Visible to display the selected TQL node in the editing pane. When this option is cleared, an invisible box  appears to the right of the selected TQL node in the editing pane.</p> <div data-bbox="572 925 886 1216" data-label="Diagram"> <pre> graph TD Windows[Windows] -- Contained --> IP[IP] Windows -- Member --> Network[Network] style Network stroke-dasharray: 5 5 </pre> </div> <p>Any query results pertaining to that TQL node are not displayed in the topology map. This can be useful when certain relationships or TQL nodes are required to build the query but are not needed in the results. For example, Windows are connected to the network by defining specific IPs, but in any query results you may want to view the IP elements only and not the Windows elements.</p> |

Attribute Tab

| | |
|--------------------------|---|
| Description | <p>Enables you to create an expression defining conditions that restrict the number of nodes that appear in the query:</p> <ul style="list-style-type: none"> ➤ Add an attribute condition to a node or relationship. ➤ Filter the query results. <p>To access:</p> <ul style="list-style-type: none"> ➤ Click the Attribute tab in the Node/Relationship Properties dialog box. or ➤ Click Next in the New TQL Relationship Page in the TQL Node Wizard. |
| Included in Tasks | <ul style="list-style-type: none"> ➤ “Define a Report Rule – Scenario” on page 246 ➤ “Define a Correlation Rule – Workflow” on page 179 ➤ “Define an Enrichment Rule – Scenario” on page 300 ➤ “Create a TQL Query” on page 285 ➤ “Create a Pattern View” on page 144 ➤ “Implement a Pattern” in <i>Discovery and Dependency Mapping Guide</i>. |

The following elements are included (unlabeled GUI elements are shown in angle brackets>):

| GUI Element (A-Z) | Description |
|---|---|
|  | Add the attribute condition you have defined. |
|  | Delete an attribute definition. |
|  | Move a selected row up. |
|  | Move a selected row down. |
|  | View the condition definition. |
| And/Or | Click inside the And/Or field and select either And or Or to link multiple conditions. |





| GUI Element (A-Z) | Description |
|---|--|
| Attribute name | Choose an attribute from the list. |
|  Brackets | Click inside the Brackets box to display a list of brackets you can use to build more complex, logical statements. |
| Criteria | Contains the attribute condition definition as defined in the Element Instances dialog box. |
| Fixed value | <p>Select one of the following options:</p> <p>Fixed value. You cannot change the value of the parameter.</p> <p>Parameterized value. Enables you to change the value of the parameter.</p> <ul style="list-style-type: none"> ▶ When a parameterized value is selected in View Manager, an option called Set View Element Parameters is included in the right-click menu. For details on how to change the value when using the TQL, see “Layout Settings Dialog Box” on page 374. <p>Note: If you select this option, you can enter a value here that is saved in the view. If you do not enter a value here, you are forced to enter one before saving the view.</p> <ul style="list-style-type: none"> ▶ When a parameterized value is selected in Topology Report Manager, a Set parameters values option is displayed at the top right of a generated Topology report, enabling you to edit the predefined parameters of node conditions in a Topology report. For details, see “Topology Report” on page 591. |
| Not | <p>Select NOT if you want the condition statement to do the opposite of what is defined.</p> <p>Note: If you select NOT, query results do not include data from the CI instances that were not assigned a value. For example, your system contains three hosts: Host1 is assigned the value A, Host2 is assigned the value B and Host3 is not assigned a value. You create a query to retrieve all hosts that are equal to A and select NOT; the results of your query only include Host2 because Host3 is not assigned a value.</p> |

| GUI Element (A-Z) | Description |
|-------------------|---|
| Operator | Select the required operator. For details, see “Attribute Operator Definitions” on page 346. |
| Update | Update an attribute condition that has been modified. |
| Value | Enter or select the value of the attribute. The Value options vary according to the attribute type you select. |

Cardinality Tab

| | |
|------------------------------|---|
| Description | <p>Define a relationship cardinality, which enables you to define how many CI instances you expect to have at the end of a relationship in your query result.</p> <p>Select the required relationship to which the selected node is attached. Then define the lower and upper limits for including the node at the other end of the relationship in the query results.</p> <p>You can define relationship conditions that enable the relationship’s connecting node to be included in the TQL query results by creating an expression defining that condition. For an example, see “Example of a Relationship Condition” on page 381.</p> <p>To access: Click the Cardinality tab in the Node/Relationship Properties dialog box.</p> |
| Important Information | This tab appears only when a node is selected. |
| Included in Tasks | <ul style="list-style-type: none"> ➤ “Define a Report Rule – Scenario” on page 246 ➤ “Define a Correlation Rule – Workflow” on page 179 ➤ “Define an Enrichment Rule – Scenario” on page 300 ➤ “Create a TQL Query” on page 285 ➤ “Create a Pattern View” on page 144 ➤ “Implement a Pattern” in <i>Discovery and Dependency Mapping Guide</i>. |

The following elements are included (unlabeled GUI elements are shown in angle brackets>):

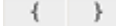
| GUI Element (A-Z) | Description |
|---|--|
|  | Add the cardinality definition you have defined. |
|  | Delete a cardinality definition from the Cardinality area. |
|  | Move a selected row up. |
|  | Move a selected row down. |
|  | View the cardinality condition definition. |
| And/Or | Click inside the And/Or field and select either And or Or to link multiple conditions. |
|  Brackets | Click inside the Brackets box to display a list of brackets you can use to build more complex, logical statements. |
| Criteria | Contains the attribute condition definition as defined in the Element Instances Dialog Box. |
| Max | Enter the value that defines the upper limits for including the node at the other end of the relationship in the query results. Note: You can use an asterisk (*) in the Max box to represent an infinite value. |
| Min | Enter the value that defines the lower limits for including the node at the other end of the relationship in the query results. For example, if <end_1> is IP and <end_2> is Windows , entering 1 in the Min box and asterisk (*) in the Max box instructs the system to retrieve only those IPs that are connected to at least one Windows operating system. (The asterisk indicates an infinite value.) Entering 3 in the Min box and asterisk (*) in the Max box instructs the system to retrieve only those Windows operating systems that are connected to at least three IPs. |

| GUI Element (A-Z) | Description |
|-------------------|---|
| Node | Select the required relationship to which the selected node is attached. The list contains all the relationships that are linked to the selected node. |
| Not | Select NOT if you want the condition statement to do the opposite of what is defined. Note: If you select NOT , query results do not include data from the CI instances that were not assigned a value. For example, your system contains three hosts: Host1 is assigned the value A, Host2 is assigned the value B and Host3 is not assigned a value. You create a query to retrieve all hosts that are equal to A and select NOT ; the results of your query only include Host2 because Host3 is not assigned a value. |
| Update | Update a cardinality definition that has been modified. |

Example of a Relationship Condition

The example of relationship conditions is based on the following TQL query:

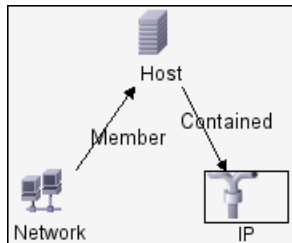

In the Relationship Cardinality dialog box, the following relationship conditions are defined for the TQL:

- Member – **Min: 1, Max: ***
- Contained – **Min: 2, Max: 4**

Using the OR operator, the definitions appear in the **Cardinality** section, as follows:

| NOT | { | Criteria | } | And/Or |
|--------------------------|---|-------------------------------|---|--------|
| <input type="checkbox"/> | | Member (Network, Host) : 1..* | | OR |
| <input type="checkbox"/> | | Contained (Host, IP) : 2..4 | | |

- [member (Network, Host)] OR [contained (Host, IP)] means that the host must either have between two and four IPs OR be a member of the network.

Using the AND operator, the definitions appear in the **Cardinality** section, as follows:

| NOT | { | Criteria | } | And/Or |
|--------------------------|---|-------------------------------|---|--------|
| <input type="checkbox"/> | | Member (Network, Host) : 1..* | | AND |
| <input type="checkbox"/> | | Contained (Host, IP) : 2..4 | | |

- [member (Network, Host)] AND [contained (Host, IP)] means that the host must have between two and four IPs AND also be a member of the network.

Qualifier Tab

| | |
|------------------------------|---|
| Description | <p>Enables you to define qualifier conditions for the selected node or relationship. For example, you can use a qualifier to define a CIT as abstract, meaning you cannot create instances from it.</p> <p>To access: Click the Qualifier tab in the Node/Relationship Properties dialog box.</p> |
| Included in Tasks | <ul style="list-style-type: none"> ➤ “Define a Report Rule – Scenario” on page 246 ➤ “Define a Correlation Rule – Workflow” on page 179 ➤ “Define an Enrichment Rule – Scenario” on page 300 ➤ “Create a TQL Query” on page 285 ➤ “Create a Pattern View” on page 144 ➤ “Implement a Pattern” in <i>Discovery and Dependency Mapping Guide</i>. |
| Important Information | <p>Important: By default, multiple selection links the conditions with the OR operator.</p> |





The following elements are included (unlabeled GUI elements are shown in angle brackets>):

| GUI Element (A-Z) | Description |
|---------------------------|--|
| ABSTRACT_CLASS | You cannot create instances of this CIT. |
| BLE_LINK_CLASS. | Relevant to HP Business Availability Center only. |
| CONTAINER | This qualifier is assigned to relationships that signify a containment relationship, such as Member, Container link, Contains, or Contained. |
| HIDDEN_CLASS | Instances of this CIT do not appear anywhere in the application. |
| ITU_HIDDEN_CLASS | Instances of this CIT do not appear in the topology map application. |
| MAJOR_APP | CI types that are assigned this qualifier appear in the Major Application Type Breakdown overview report. For details, see “Major Application Type Breakdown Report” on page 632. |
| MODELING_ENABLED | Enables a CIT to act as model in Modeling Studio. For details, see “Business CI Models” on page 86. |
| NETWORK_DEVICES | A qualifier common to all the CI types that represent a network device. It can be used for TQL queries related to network devices and serves as a replacement for CI types in a query. |
| Negate Qualifiers | If this check box is selected, then multiple selection links the conditions with the AND operator. |
| PM_SUSPECT | Relevant to HP Business Availability Center only. |
| ProtocolDialog | For internal use only. |
| ProtocolFields | For internal use only. |
| READ_ONLY_CLASS | This CIT cannot be edited. |
| TRACK_LINK_CHANGES | Changes that occur in the specified relationship appear in Change reports. For details, see “Change Report” on page 585. |

Identity Tab

| | |
|------------------------------|---|
| Description | <p>Enables you to filter the TQL results according to the element ID of the instances found for the selected TQL node.</p> <p>Move the required element from the Optional identities pane on the left to the Selected identities pane on the right to define what you want included in the TQL results using the left and right arrows.</p> <p>To access: Click the Identity tab in the Node Properties dialog box.</p> |
| Included in Tasks | <ul style="list-style-type: none"> ▶ “Define a Report Rule – Scenario” on page 246 ▶ “Define a Correlation Rule – Workflow” on page 179 ▶ “Define an Enrichment Rule – Scenario” on page 300 ▶ “Create a TQL Query” on page 285 ▶ “Create a Pattern View” on page 144 ▶ “Implement a Pattern” in <i>Discovery and Dependency Mapping Guide</i>. |
| Important Information | <p>This tab appears only when a node is selected.</p> |

The following elements are included (unlabeled GUI elements are shown in angle brackets>):

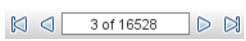
| GUI Element (A-Z) | Description |
|---|--|
|  | <p>Filter the CI instances you want to display for the selected node. Opens the Filter CI Instances dialog box.</p> |
|  | <p>Clear the filter definitions you created in the Filter CI Instances dialog box.</p> |
|  | <p>Hide or display specific columns. For details, see “Select Columns Dialog Box” in <i>Reference Information</i>.</p> |
|  | <p>Update the table.</p> |
|  | <p>Click to navigate through the results page by page or to jump to the first or last page.</p> |

| GUI Element (A-Z) | Description |
|---------------------------------|--|
| Optional identities pane | Displays all the instances found for the selected TQL node. For details, see “Optional Identities Pane” on page 385. |
| Selected identities pane | Displays the elements that are used to define what should be included in the TQL results. For details, see “Selected Identities Pane” on page 385. |
| Set Rows per Page | Determine the number of CI instances that appear on a page. |

Optional Identities Pane

| | |
|--------------------|--|
| Description | Displays all the instances found for the selected TQL node in a table. To access: Click the Identity tab in the Node Properties dialog box. |
|--------------------|--|

The following elements are included (unlabeled GUI elements are shown in angle brackets>):

| GUI Element (A-Z) | Description |
|----------------------|--|
| CI Type | The CI type. |
| Display label | The label that is displayed for the node’s instance. |

Selected Identities Pane

| | |
|--------------------|---|
| Description | Displays the elements that are used to define what should be included in the TQL results. To access: Click the Identity tab in the Node Properties dialog box. |
|--------------------|---|

The following elements are included (unlabeled GUI elements are shown in angle brackets>):

| GUI Element (A-Z) | Description |
|-------------------|--|
| CI Type | The CI type. |
| Display label | The label that is displayed for the node's instance. |

Refine Node Type Dialog Box

| | |
|------------------------------|---|
| Description | <p>Enables you to change the CI type of the TQL node after you have created a TQL query.</p> <p>To access: Right-click the required node and select Refine Node Type.</p> <p>Note: If you are using Enrichment Manager, select TQL mode at the top of the editing pane to display the Refine Node Type option.</p> |
| Included in Tasks | <ul style="list-style-type: none"> ➤ “Define a Report Rule – Scenario” on page 246 ➤ “Define a Correlation Rule – Workflow” on page 179 ➤ “Define an Enrichment Rule – Scenario” on page 300 ➤ “Create a TQL Query” on page 285 ➤ “Create a Pattern View” on page 144 ➤ “Implement a Pattern” in <i>Discovery and Dependency Mapping Guide</i>. |
| Important Information | <p>You can change the CI type to a type from one of the CI type's children, if one exists. If one does not exist, this option does not appear.</p> |

The following elements are included (unlabeled GUI elements are shown in angle brackets>):

| GUI Element (A-Z) | Description |
|---------------------------------------|------------------------------|
| List of CI types from which to choose | Select the required CI type. |





Select Relationship Type Dialog Box



| | |
|------------------------------|---|
| Description | <p>Enables you to select the type of TQL relationship to be created.</p> <p>To access: In the editing pane of IT Universe, Query Manager, View Manager, Correlation Manager, Enrichment Manager, and in the Topology Report Manager, click the Create Relationship  button in the toolbar and draw a line between two nodes. The Select Relationship Type dialog box opens automatically.</p> |
| Important Information | <p>Select one of the following relationship types:</p> <ul style="list-style-type: none"> ▶ Regular Relationship. For details, see “Add/Edit Relationship Dialog Box” on page 362. ▶ Join Relationship. For details, see “Add/Edit Join Relationship Dialog Box” on page 359. ▶ Compound Relationship. For details, see “Add/Edit Compound Relationship Dialog Box” on page 355. ▶ Calculated Relationship. For details, see “Add/Edit Calculated Relationship Dialog Box” on page 353. |
| Included in Tasks | <ul style="list-style-type: none"> ▶ “Define a Report Rule – Scenario” on page 246 ▶ “Define a Correlation Rule – Workflow” on page 179 ▶ “Define an Enrichment Rule – Scenario” on page 300 ▶ “Create a TQL Query” on page 285 ▶ “Create a Pattern View” on page 144 ▶ “Implement a Pattern” in <i>Discovery and Dependency Mapping Guide</i>. |

Subgraph Condition Definition Dialog Box



| | |
|------------------------------|--|
| Description | <p>Enables you to create conditions that restrict the number of nodes that appear in a query.</p> <p>Contains the following tabs:</p> <ul style="list-style-type: none"> ➤ Conditions. Enables you to define attribute conditions for nodes and relationships. See a description of the elements in the Conditions tab in the table below. ➤ Qualifiers. Enables you to define qualifier conditions for the selected node or relationship. For details, see “Qualifier Tab” on page 382. <p>To access: Click CONDITION  in the Add Triplet dialog box.</p> |
| Important Information | <p>Important: The Condition fields are displayed only when you access the Add Triplet dialog box from the Subgraph Definition dialog box.</p> |
| Included in Tasks | <ul style="list-style-type: none"> ➤ “Define a Report Rule – Scenario” on page 246 ➤ “Define a Correlation Rule – Workflow” on page 179 ➤ “Define an Enrichment Rule – Scenario” on page 300 ➤ “Create a TQL Query” on page 285 ➤ “Create a Pattern View” on page 144 ➤ “Internet Information Services (IIS)” in <i>Discovery and Dependency Mapping Content Guide</i> |

The following elements are included (unlabeled GUI elements are shown in angle brackets>):



| GUI Element (A-Z) | Description |
|---|---|
|  | Add the subgraph condition definition. |
|  | Delete the subgraph condition definition. |
|  | Move a selected row up. |
|  | Move a selected row down. |

| GUI Element (A-Z) | Description |
|---|--|
|  | View the subgraph condition definition. |
| And/Or | Click inside the And/Or field and select either And or Or to link multiple conditions. |
| Attribute name | Choose an attribute from the list. |
|  Brackets | Click inside the Brackets box to display a list of brackets you can use to build more complex, logical statements. |
| Criteria | Contains the attribute condition definition as defined in the Element Instances Dialog Box. |
| CIT | Contains the CIT selected from the Source and Target lists. |
| Not | <p>Select NOT if you want the condition statement to do the opposite of what is defined.</p> <p>Note: If you select NOT, query results do not include data from the CI instances that were not assigned a value. For example, let us assume that your system contains three hosts. Host1 is assigned the value A, Host2 is assigned the value B and Host3 is not assigned a value. If you create a query in which you want to retrieve all hosts that are equal to A and you select NOT, the results of your query only include Host2 because Host3 is not assigned a value.</p> |
| Operator | Select the required operator. For details, see “Attribute Operator Definitions” on page 346. |
| Value | Enter or select the value of the attribute. The Value options vary according to the attribute type you select. |



Subgraph Definition Dialog Box

| | |
|-------------------------------------|---|
| <p>Description</p> | <p>Enables you to create a graph that represents additional TQL query data related to a specific CI.</p> <p>To access in Topology Report Manager, Enrichment Manager, Correlation Manager, Query Manager, and View Manager: In the editing pane, right-click the required node and select Subgraph Definition.</p> <p>Note: If you are using Enrichment Manager, select TQL mode at the top of the editing pane to display the Subgraph Definition option.</p> <p>To access in Manage Discovery Resources in Discovery:</p> <ol style="list-style-type: none"> 1 Select a pattern in the Discovery Resources pane. 2 In the Pattern Signature tab, click the  Edit Input TQL button to the right of the Input TQL box to open the Input TQL Editor. 3 Right-click the required node and select Subgraph Definition. |
| <p>Important Information</p> | <p>The following icon is displayed next to the node for which you define a subgraph:</p>  |
| <p>Included in Tasks</p> | <ul style="list-style-type: none"> ➤ “Define a Report Rule – Scenario” on page 246 ➤ “Define a Correlation Rule – Workflow” on page 179 ➤ “Define an Enrichment Rule – Scenario” on page 300 ➤ “Create a TQL Query” on page 285 ➤ “Create a Pattern View” on page 144 ➤ “Implement a Pattern” in <i>Discovery and Dependency Mapping Guide</i>. |
| <p>Useful Links</p> | <p>“Subgraph Definition” on page 328</p> <p>“Create a Subgraph Definition — Scenario” on page 337</p> |

The following elements are included (unlabeled GUI elements are shown in angle brackets>):

| GUI Element (A-Z) | Description |
|---|---|
|  | Add a subgraph definition. Opens the Add Triplet dialog box. |
|  | Delete a subgraph definition. |
|  | Edit a subgraph definition. Opens the Edit Triplet dialog box. |
| Depth | A number that represents the longest path (that is, the maximum connecting nodes) allowed between two CIs in the CMDB that should be included in the DDM process. Default: 5 |
| Element condition exists | A green asterisk appears next to either the source, relationship, or target in the subgraph definition if an attribute condition has been defined for one of them in the Subgraph Condition Definition dialog box. For details, see “Subgraph Condition Definition Dialog Box” on page 388. |
| Relationship | The relationship selected in the Add Triplet dialog box connecting the source to the target node. |
| Relationship Direction | The direction of the relationship selected in the Add Triplet dialog box, indicating which node is dependent on the other. |
| Source | The required source node selected in the Add Triplet dialog box. |
| Target | The required target node selected in the Add Triplet dialog box. |

TQL Node Wizard

| | |
|-------------------------------------|--|
| <p>Description</p> | <p>Enables you to build a TQL query.</p> <p>To access in Topology Report Manager, Enrichment Manager, Correlation Manager, Query Manager, and View Manager: In the editing pane, right-click the required node and select TQL Node Wizard.</p> <p>Note: If you are using Enrichment Manager, select TQL mode at the top of the editing pane.</p> <p>To access in Job Configuration in Discovery:</p> <ol style="list-style-type: none"> 1 Select a job in the Discovery Modules pane. 2 Select a Trigger TQL in the Properties pane. Click the Open the TQL Editor  button to open the Trigger TQL Editor. 3 Right-click the required node and select TQL Node Wizard. <p>To access in Manage Discovery Resources in Discovery:</p> <ol style="list-style-type: none"> 1 Select a pattern in the Discovery Resources pane. 2 In the Pattern Signature tab, click the  Edit Input TQL button to the right of the Input TQL box to open the Input TQL Editor. 3 Right-click the required node and select TQL Node Wizard. |
| <p>Important Information</p> | <p>If the TQL query is empty, drag the required TQL nodes on to the editing pane from the tree displayed in the CI Type Selector.</p> |
| <p>Included in Tasks</p> | <ul style="list-style-type: none"> ➤ “Define a Report Rule – Scenario” on page 246 ➤ “Define a Correlation Rule – Workflow” on page 179 ➤ “Define an Enrichment Rule – Scenario” on page 300 ➤ “Create a TQL Query” on page 285 ➤ “Create a Pattern View” on page 144 ➤ “Implement a Pattern” in <i>Discovery and Dependency Mapping Guide</i>. |

| | |
|---------------------|--|
| Useful Links | “Topology Query Language” on page 324 |
| Wizard Map | The TQL Node Wizard contains: New TQL Node Page > New TQL Relationship Page > TQL Node Properties Page > Element Instances Page |

New TQL Node Page

| | |
|------------------------------|--|
| Description | Enables you to add a node to the TQL query. |
| Important Information | If the TQL query is empty, drag the required TQL node on to the editing pane from the tree displayed in the Configuration Item Types pane. For general information on the TQL Node Wizard, see “TQL Node Wizard” on page 392. |
| Wizard Map | The TQL Node Wizard contains: New TQL Node Page > New TQL Relationship Page > TQL Node Properties Page > Element Instances Page |

The following elements are included (unlabeled GUI elements are shown in angle brackets):

| GUI Element (A-Z) | Description |
|--------------------------------------|---|
| <node> is required | <p>Define the relationship cardinality. For details, see “Cardinality Tab” on page 379.</p> <ul style="list-style-type: none"> ▶ Select the <node> is required check box for each node to include a minimum of one instance of the node at the other end of the relationship in the query results. Selecting the check box gives the relationship a cardinality value of 1*. ▶ Clear the <node> is required check box to give the relationship a cardinality value of 0*. |
| <TQL Node hierarchy tree> | <p>Select the required node. The node you select appears in the Element name box.</p> <p>This list only includes the nodes of the CI types that have valid relationships to the selected (source) node.</p> <p>To the right of each node, the number of CI instances that exist in the CMDB for that CI type is displayed. The number of instances is only updated after you close the TQL Node Wizard and open it again.</p> <p>Note: The first node in the hierarchy tree is selected by default.</p> |
| Element name | <p>(Optional) Contains the name of the selected node. By default, the CI type is assigned as the element’s name.</p> <p>You can rename a TQL node in the Element name box giving it a unique label. This can be helpful when there is more than one node of the same CI type in the TQL query.</p> |
| Show only CITs with instances | <p>Select this check box to display only the CITs of which there are instances in the CMDB.</p> <p>Note: The Show only CITs with instances check box is selected by default.</p> |

 **New TQL Relationship Page**

| | |
|--------------------|--|
| Description | Enables you to add a relationship to a TQL query. |
| Wizard Map | The TQL Node Wizard contains: New TQL Node Page > New TQL Relationship Page > TQL Node Properties Page > Element Instances Page |







The following elements are included (unlabeled GUI elements are shown in angle brackets):

| GUI Element (A-Z) | Description |
|--|---|
| <TQL Relationship hierarchy tree> | Select the required relationship. The node you select appears in the Relationship Type box. |
| Direction | Select the required relationship direction. The direction indicates which node is dependent on the other. |
| Relationship direction | Select the required relationship direction. The direction indicates which node is dependent on the other. |
| Relationship Type | A valid relationship that defines the connection between the selected nodes. The box displays the relationship you selected in the relationship hierarchy tree. |
| Show only relationships with instances | Display only the relationships of which there are instances in the CMDB. |

TQL Node Properties Page

| | |
|--------------------|---|
| Description | Enables you to create an expression that restricts the number of nodes that appear in the query by adding an attribute condition to a node or relationship. |
| Wizard Map | The TQL Node Wizard contains: New TQL Node Page > New TQL Relationship Page > TQL Node Properties Page > Element Instances Page |

The following elements are included (unlabeled GUI elements are shown in angle brackets>):

| GUI Element (A-Z) | Description |
|---|---|
|  | Add an attribute condition. |
|  | Delete an attribute condition. |
|  | Move a selected row up. |
|  | Move a selected row down. |
|  | View the condition definition. |
| And/Or | Click inside the And/Or field and select either And or Or to link multiple conditions. |
| Attribute name | Choose an attribute from the list. |
|  Brackets | Click inside the Brackets box to display a list of brackets you can use to build more complex, logical statements. |
| Criteria | Contains the attribute condition definition as defined in the Element Instances Dialog Box. |

| GUI Element (A-Z) | Description |
|-------------------------|---|
| Fixed value | <p>Select one of the following options:</p> <p>Fixed value. You cannot change the value of the parameter.</p> <p>Parameterized value. Enables you to change the value of the parameter.</p> <ul style="list-style-type: none"> ▶ When a parameterized value is selected in View Manager, an option called Set View Element Parameters is included in the right-click menu. For details on how to change the value when using the TQL, see “Set View Parameters/Set View Element Parameters Dialog Box” on page 163. <p>Note: If you select this option, you can enter a value here that is saved in the view. If you do not enter a value here, you are forced to enter one before saving the view.</p> <ul style="list-style-type: none"> ▶ When a parameterized value is selected in Topology Report Manager, a Set parameters values option is displayed in a generated Topology report, enabling you to edit the predefined parameters of node conditions in a Topology report. For details, see “Topology Report” on page 591. |
| Include subtypes | Display both the selected CI and its children in the topology map. |
| Not | <p>Select NOT if you want the condition statement to do the opposite of what is defined.</p> <p>Note: If you select NOT, query results do not include data from the CI instances that were not assigned a value. For example, your system contains three hosts: Host1 is assigned the value A, Host2 is assigned the value B and Host3 is not assigned a value. You create a query to retrieve all hosts that are equal to A and select NOT; the results of your query only include Host2 because Host3 is not assigned a value.</p> |
| Operator | Select the required operator. For details, see “Attribute Operator Definitions” on page 346. |

| GUI Element (A-Z) | Description |
|-------------------|---|
| Update | Update an attribute condition that has been modified. |
| Value | Enter or select the value of the attribute. The Value options vary according to the attribute type you select. |
| Visible | <p>Select Visible to display the selected TQL node in the editing pane. When Visible is cleared, an invisible box  appears to the right of the selected TQL node in the editing pane.</p> <div data-bbox="584 508 901 800" data-label="Diagram"> <pre> graph TD Windows[Windows] -- Contained --> IP[IP] Windows -- Member --> Network[Network] subgraph Box [] Network end style Network stroke-width:2px </pre> </div> <p>Any query results pertaining to that TQL node are not displayed in the topology map. This can be useful when certain relationships or TQL nodes are required to build the query but are not needed in the results. For example, Windows are connected to the network by defining specific IPs, but in any query results you may want to view the IP elements only and not the Windows elements.</p> |

 **Element Instances Page**

| | |
|------------------------------|--|
| Description | Displays all the instances found for the selected TQL node in a table. |
| Important Information | <p>The columns displayed in the report vary according to the CI type selected.</p> <p>By default, only columns corresponding to attributes that have been defined with the Asset Data, Change Monitored, and Comparable attribute qualifiers in the CIT Manager are displayed as columns in the dialog box. For details, see “Attributes Page” on page 228.</p> <p>If required, you can click the Display Hidden Columns button to display the attributes that are defined as Visible but not Static. For details on Static attributes, see “Attributes Page” on page 228.</p> <p>Note: For information on the elements included in the Element Instances page, see “Element Instances Dialog Box” on page 368.</p> |
| Wizard Map | <p>The TQL Node Wizard contains:</p> <p>New TQL Node Page > New TQL Relationship Page > TQL Node Properties Page > Element Instances Page</p> |

User Preferences Dialog Box

| | |
|------------------------------|---|
| Description | Enables you to reset system preferences. To access: Select Edit > User Preferences . |
| Important Information | All the preferences you select (such as whether to display certain wizard pages or warning message preferences) are stored in the system. This dialog box enables you to reset those preferences. |

The following elements are included (unlabeled GUI elements are shown in angle brackets):

| GUI Element (A-Z) | Description |
|--------------------------|--|
| <Left pane> | Select the preferences page to edit. The following options are available: <ul style="list-style-type: none"> ▶ Wizard Preferences ▶ Optional Messages Preferences ▶ Discovery Preferences |
| Preferences list | The list of warning messages and their user-selected preferences. |
| Reset Page | Click to reset the selected preference to its default value. |
| Reset All | Click to reset all the preferences to their default values. |

Troubleshooting and Limitations

For TQL queries to be valid, they must comply with certain restrictions.

This section includes the following topics:

- “Understanding Validation Restrictions” on page 401
- “Correlation TQL Validation” on page 403
- “Enrichment TQL Validation” on page 404

Understanding Validation Restrictions

For Correlation, Enrichment, and DDM TQL types to be valid, they must comply with the following restrictions:

- **Self Relationships.** A TQL must not contain self relationships, that is, a relationship must not lead from a node to itself, as the following example illustrates:

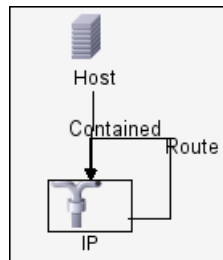

- **Cyclic Graph.** The TQL structure cannot be a closed circle, as shown in the following example:

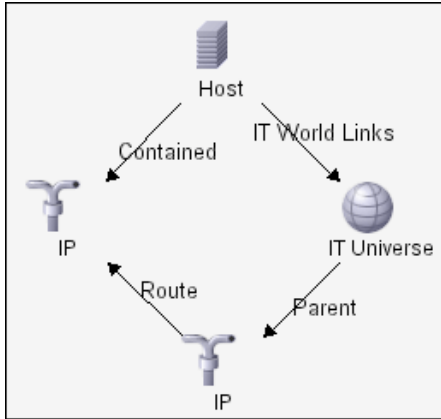

- **Separate Nodes and Groups.** All the TQL nodes must be linked to one another, that is, the TQL cannot contain separate nodes or groups, as the following example illustrates:

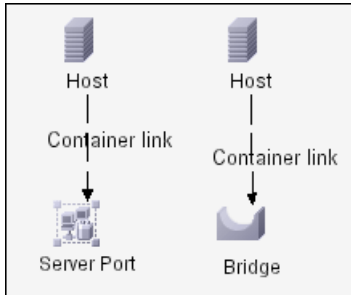

Note: This restriction also applies to Report TQLs.

Correlation TQL Validation

A Correlation TQL must also comply with the following restrictions:

- **Number of nodes.** A Correlation TQL must consist of at least two nodes.
- **Trigger and affected nodes must be connected.** There must be a path of relationships from the triggered node to the affected nodes.
- **Selecting nodes to function as Correlation triggers.** When selecting nodes to function as Correlation triggers, the nodes must comply with the following restrictions:
 - You can select more than one node as a trigger. However, you cannot define a node as affected and as a trigger.
 - If a node has a relationship whose minimum limit is 0 (meaning that one of its ends does not necessarily have a node linked to it), the node that is linked to its other end cannot be a root cause node (because it may or may not exist in the TQL). For details about minimum limits, see “Cardinality Tab” on page 379. For example, **IT Universe** cannot be either a root cause or affected node because it is connected to the host with a **Min** limit of 0.

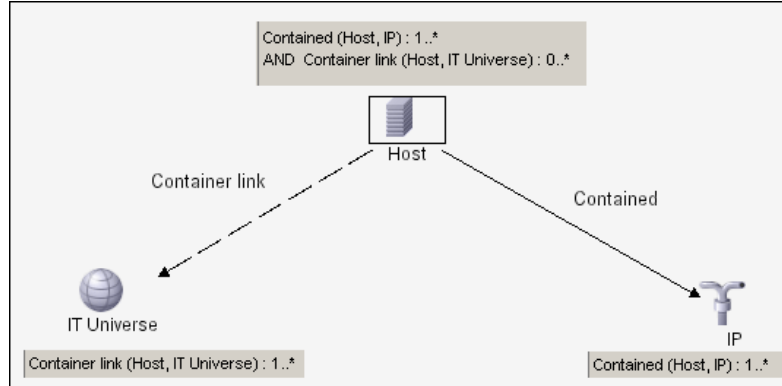

Note: A node that is not visible cannot be a root cause or an affected node.

- ▶ **The connection between trigger and affected nodes.** The trigger node and affected nodes you define must be connected by a path of relationships from the triggered node to the affected nodes.

Enrichment TQL Validation

Enrichment TQL queries must comply with the following restriction:

- ▶ **Required elements.** You cannot perform Enrichment on a non-required node, that is, a node that does not necessarily appear in the TQL results.

Example 1. In this example, the TQL results can be either **A** and **B** or **A** and **C**. Therefore, you cannot add an Enrichment node to nodes **B** or **C** because they are not required elements. You can add an Enrichment node to node **A** because it always appears in the TQL results. For details on how to add Enrichment nodes and relationships, see “Add Enrichment Nodes and Relationships to an Enrichment TQL Query” on page 331.

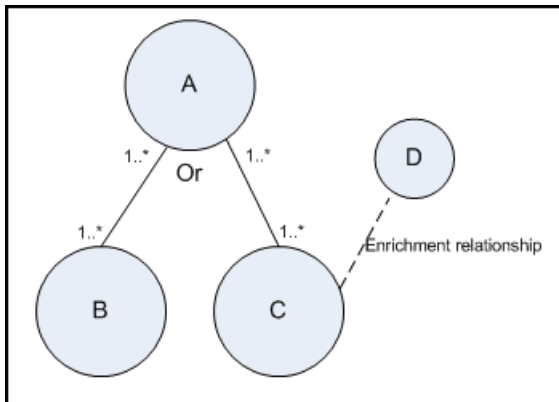

Example 2. In this example, both **A** and **B** are required elements that always appear in the TQL results. Only **C** is not a required element because it has a cardinality of 0. Therefore, you cannot add an Enrichment node to it.

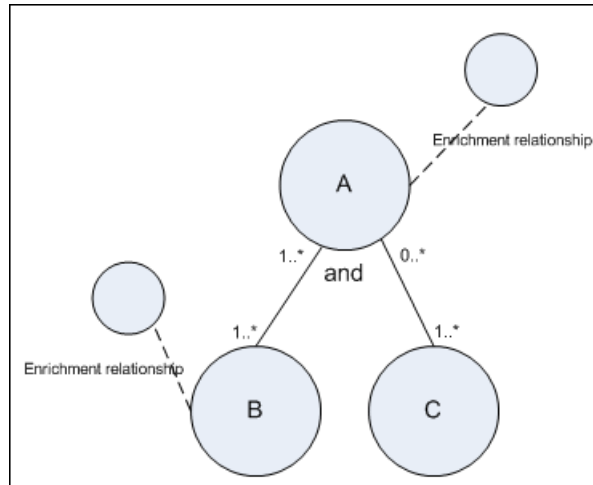

11

Using Calculated Relationships

This chapter provides information on calculated relationships.

This chapter includes:

Concepts

- ▶ Calculated Relationships Overview on page 407
- ▶ Calculated Relationships on page 408
- ▶ Calculated Relationship Types on page 409

Calculated Relationships Overview

You can use calculated relationships to create TQL queries just like any other relationship in the CI Type model. This enables you to base Enrichment rules, Correlation rules, Report rules, and views on calculated relationships.

Calculated relationships affect the results of all TQLs that use that calculated relationship since calculated relationships are part of the class model.

Calculated Relationships

Calculated relationships are defined by one or more triplets. For details, see “Triplets Page” on page 232. Each triplet is defined by the following components:

- ▶ One source CI type
- ▶ One target CI type
- ▶ A physical relationship that links the two CI types
- ▶ The required direction. The direction can be identical to or opposite from the direction of the relationship in the class model.

Since calculated relationships are defined by physical relationships from within the class model, their lifetime is determined by the lifetime of the physical relationships. When the physical relationship in the class model is removed, the corresponding calculated relationship is removed from all view results as well.

Note: If you create a new CI type or relationship in the CI Type Manager, you need to define the required triplets. For example, Change report displays changes based on calculated relationships. To include the changes for the new CI type in the Change report, you need to define the appropriate triplet.

Example of a Triplet Definition



Calculated Relationship Types

There are two types of out-of-the-box calculated relationships. Each one represents a different type of relation.

- Impacted by (Directly)
- Impacted By (Potentially)

The example below illustrates the difference between the Impacted By (Directly) and Impacted By (Potentially) relationships.

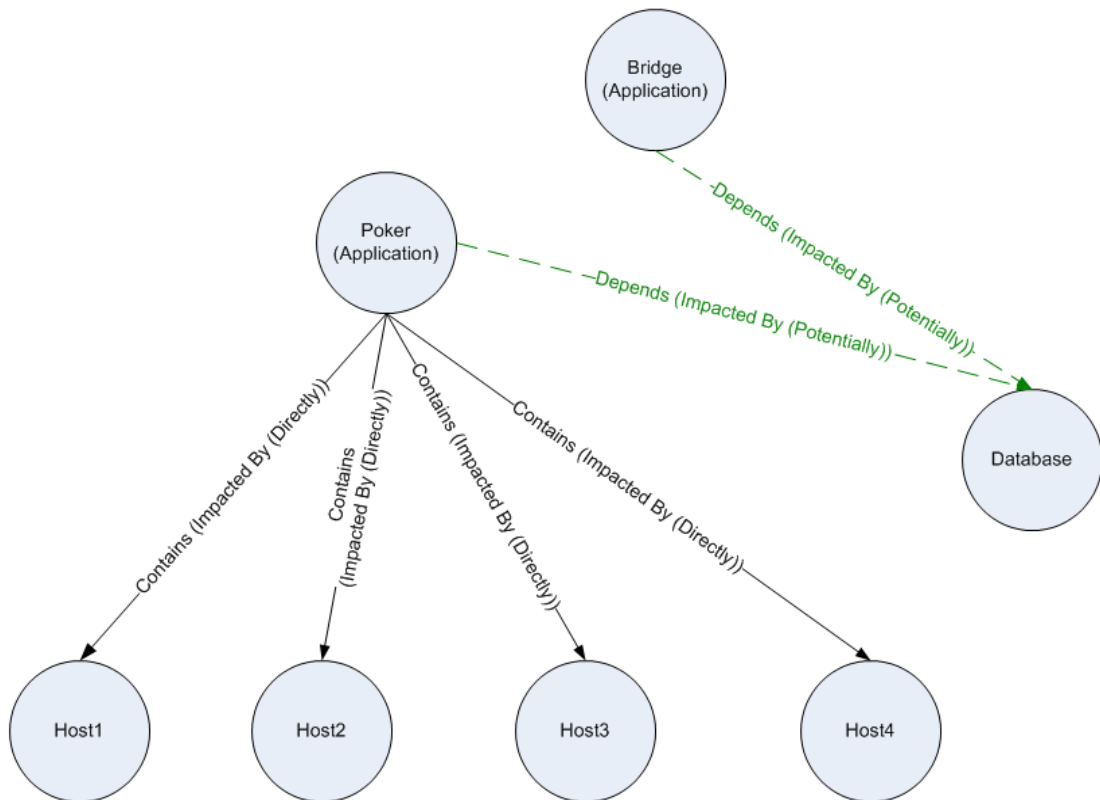

- If **Host4** experiences downtime, it impacts only the **Poker** application.

- If the **Database** CI experiences downtime, it impacts both the **Poker** and **Bridge** applications.
- If there is a planned downtime for **Poker**:
 - The four hosts are also in downtime because they are contained within the **Poker** application.
 - The **Database** CI continues to be active.

Although this illustration maps a **Contains** relationship to an **Impacted By (Directly)** relationship and a **Depends** relationship to an **Impacted By (Potentially)** relationship, you can use calculated relationships to replace a number of relationships. This enables you to reduce the number of relationships you need to include when creating TQLs.

For details on defining the connection between two nodes using a calculated relationship, see “Add/Edit Calculated Relationship Dialog Box” on page 353.

You can also define new calculated relationships to suit your business needs. For details, see “Triplets Page” on page 232.

12

Create a URL for a Direct Link

This chapter provides information on how to create a URL that guides another user to a specific target view or CI in HP Universal CMDB.

This chapter includes:

Concepts

- ▶ Generate a Direct Link – Overview on page 411

Tasks

- ▶ Generate a Direct Link – Scenario on page 413

Reference

- ▶ Generate Direct Link User Interface on page 413

Generate a Direct Link – Overview

You can create a URL that:

- ▶ Opens a specific HP Universal CMDB view or CI directly in HP Universal CMDB. This enables users to retrieve information from HP Universal CMDB without being located in the HP Universal CMDB context.

Note: To open a specific view or CI directly in HP Universal CMDB, use the **Open in context links** option. For details, see “Select Command Page” on page 415.

- ▶ Enables integration with HP Universal CMDB:
 - ▶ If you create a URL using the Embedded links option, the URL takes you first to the HP Universal CMDB login page. After you enter your login name and password, the target page opens in your browser.

Note: To open the target page in your browser, use the **Embedded links** option. For details, see “Select Command Page” on page 415.

- ▶ (Intended for integration developers only) You can directly embed a UCMDB applet into external applications. For details, see “Embedding UCMDB Applets Using Direct Links” in *Integrations*.

When you create a URL, you can:

- ▶ Send the URL to an email recipient
- ▶ Copy the URL to the clipboard
- ▶ Test the URL to ensure that the target application page can be found

The user to whom you are sending the URL must have an account with sufficient privileges to open the target page. You must apply the appropriate viewing and editing permissions to the users and user groups that want to access the target view. You set permissions in **Admin > Settings > Users and Roles**. For details, see “Users and Roles User Interface” on page 641.

Generate a Direct Link – Scenario

This scenario describes how to generate a direct link to email the URL of a specific CI to another person.

Jane Harrison is a senior engineer in the ABC Software company. She has encountered a problematic CI in a view she has created. She wants to inform Henry Jones, who is working with the same view through HP ServiceCenter, about the problematic CI. Since the view Jane has created contains many hundreds of CIs, she decides to email Henry the URL of the CI so that he does not have to spend a lot of time searching for that specific CI.

In IT Universe, Jane selects the **Generate Direct Link** wizard from the **Edit** menu. In the Select Command page, she selects the **Show View** option and clicks **Next**.

In the Direct Link Parameters — Show View page, she selects the view she created, the problematic CI, and IT Universe as the mode in which Henry should open the CI. When the URL is created, she emails Henry the link to the problematic CI.

For details on the Generate Direct Link wizard, see “Generate Direct Link Wizard” on page 415.

Generate Direct Link User Interface

This section describes:

- Generate Direct Link Dialog Box on page 414
- Generate Direct Link Wizard on page 415

Generate Direct Link Dialog Box

| | |
|--------------------------|--|
| Description | <p>Creates a URL to send to users so that they can access HP Universal CMDB.</p> <p>To access: Click the Generate Direct Link to View button in:</p> <ul style="list-style-type: none"> ▶ Admin > Modeling > IT Universe Manager ▶ Applications > Topology View |
| Included in Tasks | “Generate a Direct Link – Scenario” on page 413 |

The following elements are included (unlabeled GUI elements are shown in angle brackets>):

| GUI Element (A-Z) | Description |
|--------------------------|---|
| Advanced | Enables you to build a direct link and choose specific elements such as views or CIs, for the end user to access. For details, see “Generate Direct Link Wizard” on page 415. |
| Copy URL | Copies the URL to the clipboard. |
| Description | Describes the parameters that are included in the URL. For details on selecting the parameters, see “Select Command Page” on page 415. |
| Link URL | The created URL that accesses the specified HP Universal CMDB function. |
| Mail URL | Opens an email containing the URL of the link. |
| Test URL | Checks the URL to ensure that the specified application page can be found. |

Generate Direct Link Wizard

| | |
|------------------------------|--|
| Description | Creates a URL that guides another user to a specific target view or CI in HP Universal CMDB, or embeds a UCMDB applet into an external application. To access: Admin > Modeling > Edit > Generate Direct Link |
| Important Information | The Welcome page includes a Do not show this page again button. |
| Included in Tasks | “Generate a Direct Link – Scenario” on page 413 |
| Wizard Map | The Generate Direct Link wizard contains: Generate Direct Link Wizard > Select Command Page > (Direct Link Parameters – CI Type Selector Page) > (Direct Link Parameters – Show Change Report Page) > (Direct Link Parameters – Show Change Report on View Page) > (Direct Link Parameters – Show CI Neighborhood Page) > (Direct Link Parameters – Show CI Properties Page) > (Direct Link Parameters – Show Impact Map Page) > (Direct Link Parameters – Show Instances Grid Page) > (Direct Link Parameters – Show Related CIs Page) > (Direct Link Parameters – Show Topology Report Page) > (Direct Link Parameters – Show View Page) > (Direct Link Parameters – Show View Topology Page) > (Direct Link Parameters – Start in Mode Page) > (Select CIs Dialog Box) > (Correlation State and Trigger Severity Dialog Box) > Finish Page |

Select Command Page

| | |
|--------------------|--|
| Description | Enables you to select the required parameters that must be added to the URL. |
|--------------------|--|

| | |
|------------------------------|--|
| Important Information | For general information about the Generate Direct Link wizard, see “Generate Direct Link Wizard” on page 415. |
| Wizard Map | <p>The Generate Direct Link wizard contains:</p> <p>Generate Direct Link Wizard ></p> <p>Select Command Page ></p> <p>(Direct Link Parameters – CI Type Selector Page) ></p> <p>(Direct Link Parameters – Show Change Report Page) ></p> <p>(Direct Link Parameters – Show Change Report on View Page) ></p> <p>(Direct Link Parameters – Show CI Neighborhood Page) ></p> <p>(Direct Link Parameters – Show CI Properties Page) ></p> <p>(Direct Link Parameters – Show Impact Map Page) ></p> <p>(Direct Link Parameters – Show Instances Grid Page) ></p> <p>(Direct Link Parameters – Show Related CIs Page) ></p> <p>(Direct Link Parameters – Show Topology Report Page) ></p> <p>(Direct Link Parameters – Show View Page) ></p> <p>(Direct Link Parameters – Show View Topology Page) ></p> <p>(Direct Link Parameters – Start in Mode Page) ></p> <p>(Select CIs Dialog Box) ></p> <p>(Correlation State and Trigger Severity Dialog Box) ></p> <p>Finish Page</p> |

The following elements are included (unlabeled GUI elements are shown in angle brackets):

| GUI Element (A-Z) | Description |
|--------------------------|---|
| <Left pane> | A graphic illustration of the selected command. |
| Description | A description of the selected command. |

| GUI Element (A-Z) | Description |
|-----------------------|---|
| Embedded links | <p>Creates a URL that enables you to embed a UCMDB applet into external applications.</p> <ul style="list-style-type: none"> ▶ Show impact map. Embeds an impact map into an external application. For details, see “Direct Link Parameters – Show Impact Map Page” on page 427. ▶ Show change report. Embeds a report displaying changes made to a specific CI into an external application. For details, see “Direct Link Parameters – Show Change Report Page” on page 420. ▶ CI type selector. Embeds the CI type selector into external applications. For details, see “Direct Link Parameters – CI Type Selector Page” on page 418. ▶ Show change report on view. Embeds a report displaying changes made to a specific view into an external application. For details, see “Direct Link Parameters – Show Change Report on View Page” on page 422. ▶ Show CI neighborhood. Embeds a topology map into an external application. For details, see “Direct Link Parameters – Show CI Neighborhood Page” on page 424. ▶ Show topology report. Embeds a Topology Report into an external application. For details, see “Direct Link Parameters – Show Topology Report Page” on page 431. ▶ Show instances grid. Displays all the CI instances found in the CMDB for a selected CI type and its children. For details, see “Direct Link Parameters – Show Instances Grid Page” on page 428. ▶ Show CI properties. Displays a CI’s properties. For details, see “Direct Link Parameters – Show CI Properties Page” on page 425. ▶ Show view topology. Displays the topology map of the selected view and embeds it in an external application. For details, see “Direct Link Parameters – Show View Topology Page” on page 435. |



| GUI Element (A-Z) | Description |
|------------------------------|---|
| Open in context links | <p>Creates a URL that guides another user to a specified application page without having to be in the HP Universal CMDB context:</p> <ul style="list-style-type: none"> ▶ Show related CIs. Opens a topology map displaying the selected CI and its immediate neighbors within the selected view. For details, see “Direct Link Parameters – Show Related CIs Page” on page 430. ▶ Show view. Displays the selected view and optionally preselects a node in it. For details, see “Direct Link Parameters – Show View Page” on page 433. ▶ Start in mode. Opens HP Universal CMDB at the selected page. For details, see “Direct Link Parameters – Start in Mode Page” on page 436. |
| Steps | The current step in the procedure. |







 **Direct Link Parameters – CI Type Selector Page**

| | |
|------------------------------|--|
| Description | Enables you to create a URL to a hierarchical tree or list of selected CI types, which you can embedded into an external application. |
| Important Information | <ul style="list-style-type: none"> ▶ For general information about the Generate Direct Link wizard, see “Generate Direct Link Wizard” on page 415. ▶ Click Finish to close the wizard and create a URL. For details, see “Generate Direct Link Dialog Box” on page 414. |

| | |
|---------------------|--|
| Useful Links | “CI Type Manager” on page 205 |
| Wizard Map | <p>The Generate Direct Link wizard contains:</p> <p>Generate Direct Link Wizard > Select Command Page > (Direct Link Parameters – CI Type Selector Page) > (Direct Link Parameters – Show Change Report Page) > (Direct Link Parameters – Show Change Report on View Page) > (Direct Link Parameters – Show CI Neighborhood Page) > (Direct Link Parameters – Show CI Properties Page) > (Direct Link Parameters – Show Impact Map Page) > (Direct Link Parameters – Show Instances Grid Page) > (Direct Link Parameters – Show Related CIs Page) > (Direct Link Parameters – Show Topology Report Page) > (Direct Link Parameters – Show View Page) > (Direct Link Parameters – Show View Topology Page) > (Direct Link Parameters – Start in Mode Page) > (Select CIs Dialog Box) > (Correlation State and Trigger Severity Dialog Box) > Finish Page</p> |

The following elements are included (unlabeled GUI elements are shown in angle brackets>):

| GUI Element (A-Z) | Description |
|-----------------------------------|--|
| CI type selector mode | View the selected CI types in either a hierarchical tree or list. |
| Invisible CITs (tree only) | <p>Select the CI types you do not want to appear in the tree.</p> <ul style="list-style-type: none"> ▶ Click  to open the CI Type Selector dialog box. Select the CI types you want to appear in the tree. ▶ Click  to delete the selected CI types. |

| GUI Element (A-Z) | Description |
|--------------------------------------|---|
| Root CI Type (tree only) | <p>Select the CI type you want to use as the root CI type in a hierarchical tree.</p> <ul style="list-style-type: none"> ▶ Click  to open the CI Type Selector dialog box. Select the CI type you want to use as the root CI type in the tree. ▶ Click  to delete the selected CI type. The default is IT Universe. |
| Selection mode | <p>Allow single or multiple selection of CI types.</p> |
| Unselectable CITs (tree only) | <p>Select the CI types which cannot be selected in the tree.</p> <ul style="list-style-type: none"> ▶ Click  to open the CI Type Selector dialog box. Select the CI types which cannot be selected in the tree. ▶ Click  to delete the selected CI types. |
| Visible CITs (list only) | <p>Select the CI types which you want to appear in the CI type list.</p> <ul style="list-style-type: none"> ▶ Click  to open the CI Type Selector dialog box. Select the CI types which you want to appear in the CI type list. ▶ Click  to delete the selected CI types. <p>Note: If you choose to view the CITs in a list, then you are required to select at least one CI type.</p> |



Direct Link Parameters – Show Change Report Page

| | |
|------------------------------|--|
| Description | <p>Enables you to create a URL to a specific Change report that displays the changes made to a specific CI and its children.</p> |
| Important Information | <ul style="list-style-type: none"> ▶ For general information about the Generate Direct Link wizard, see “Generate Direct Link Wizard” on page 415. ▶ Click Finish to close the wizard and create a URL. For details, see “Generate Direct Link Dialog Box” on page 414. |

| | |
|---------------------|--|
| Useful Links | <ul style="list-style-type: none"> ➤ “Change Report” on page 585 ➤ “Working in Reports” in <i>Reference Information</i> |
| Wizard Map | <p>The Generate Direct Link wizard contains:</p> <p>Generate Direct Link Wizard ></p> <p>Select Command Page ></p> <p>(Direct Link Parameters – CI Type Selector Page) ></p> <p>(Direct Link Parameters – Show Change Report Page) ></p> <p>(Direct Link Parameters – Show Change Report on View Page) ></p> <p>(Direct Link Parameters – Show CI Neighborhood Page) ></p> <p>(Direct Link Parameters – Show CI Properties Page) ></p> <p>(Direct Link Parameters – Show Impact Map Page) ></p> <p>(Direct Link Parameters – Show Instances Grid Page) ></p> <p>(Direct Link Parameters – Show Related CIs Page) ></p> <p>(Direct Link Parameters – Show Topology Report Page) ></p> <p>(Direct Link Parameters – Show View Page) ></p> <p>(Direct Link Parameters – Show View Topology Page) ></p> <p>(Direct Link Parameters – Start in Mode Page) ></p> <p>(Select CIs Dialog Box) ></p> <p>(Correlation State and Trigger Severity Dialog Box) ></p> <p>Finish Page</p> |

The following elements are included (unlabeled GUI elements are shown in angle brackets):

| GUI Element (A-Z) | Description |
|--------------------|---|
| Date from: | Configure a start date and time for the report. |
| Date until: | Configure an end date and time for the report. |



| GUI Element (A-Z) | Description |
|----------------------------|---|
| Source CI object ID | <p>Enables you to create a URL to a specific Change report that displays the changes made to a specific CI and its children.</p> <ul style="list-style-type: none"> ▶ Click  to select the source CI and retrieve its object ID. Opens the Select Source CI dialog box. For details, see “View Explorer” on page 676. ▶ Click  to delete the value in the Source CI object ID box. |
| Time range: | <p>Select a time range for which you want to view the report. For more information on defining a time period using the Time Range options, see “Generating Reports” in <i>Reference Information</i>.</p> |

Direct Link Parameters – Show Change Report on View Page

| | |
|------------------------------|--|
| Description | <p>Enables you to create a URL to a specific Change report that displays the changes made to a specific view.</p> |
| Important Information | <ul style="list-style-type: none"> ▶ For general information about the Generate Direct Link wizard, see “Generate Direct Link Wizard” on page 415. ▶ Click Finish to close the wizard and create a URL. For details, see “Generate Direct Link Dialog Box” on page 414. |

| | |
|---------------------|--|
| Useful Links | <ul style="list-style-type: none"> ➤ “Change Report” on page 585 ➤ “Working in Reports” in <i>Reference Information</i> |
| Wizard Map | <p>The Generate Direct Link wizard contains:</p> <p>Generate Direct Link Wizard ></p> <p>Select Command Page ></p> <p>(Direct Link Parameters – CI Type Selector Page) ></p> <p>(Direct Link Parameters – Show Change Report Page) ></p> <p>(Direct Link Parameters – Show Change Report on View Page) ></p> <p>(Direct Link Parameters – Show CI Neighborhood Page) ></p> <p>(Direct Link Parameters – Show CI Properties Page) ></p> <p>(Direct Link Parameters – Show Impact Map Page) ></p> <p>(Direct Link Parameters – Show Instances Grid Page) ></p> <p>(Direct Link Parameters – Show Related CIs Page) ></p> <p>(Direct Link Parameters – Show Topology Report Page) ></p> <p>(Direct Link Parameters – Show View Page) ></p> <p>(Direct Link Parameters – Show View Topology Page) ></p> <p>(Direct Link Parameters – Start in Mode Page) ></p> <p>(Select CIs Dialog Box) ></p> <p>(Correlation State and Trigger Severity Dialog Box) ></p> <p>Finish Page</p> |







The following elements are included (unlabeled GUI elements are shown in angle brackets>):

| GUI Element (A-Z) | Description |
|----------------------|--|
| Date from: | Configure a start date and time for the report. |
| Date until: | Configure an end date and time for the report. |
| Selected view | <ul style="list-style-type: none"> ➤ Click  to select the required view. Opens the Select View dialog box. ➤ Click  to delete the value in the Selected View box. |
| Time range: | Select a time range for which you want to view the report. For more information on defining a time period using the Time Range options, see “Generating Reports” in <i>Reference Information</i> . |

 **Direct Link Parameters – Show CI Neighborhood Page**

| | |
|------------------------------|--|
| Description | Enables you to embed into an external application, a topology map that displays a specific CI, and all the CIs that are linked to it by a distance of no more than one relationship. |
| Important Information | <ul style="list-style-type: none"> ▶ For general information about the Generate Direct Link wizard, see “Generate Direct Link Wizard” on page 415. ▶ Click Finish to close the wizard and create a URL. For details, see “Generate Direct Link Dialog Box” on page 414. |
| Wizard Map | <p>The Generate Direct Link wizard contains:</p> <p>Generate Direct Link Wizard > Select Command Page > (Direct Link Parameters – CI Type Selector Page) > (Direct Link Parameters – Show Change Report Page) > (Direct Link Parameters – Show Change Report on View Page) > (Direct Link Parameters – Show CI Neighborhood Page) > (Direct Link Parameters – Show CI Properties Page) > (Direct Link Parameters – Show Impact Map Page) > (Direct Link Parameters – Show Instances Grid Page) > (Direct Link Parameters – Show Related CIs Page) > (Direct Link Parameters – Show Topology Report Page) > (Direct Link Parameters – Show View Page) > (Direct Link Parameters – Show View Topology Page) > (Direct Link Parameters – Start in Mode Page) > (Select CIs Dialog Box) > (Correlation State and Trigger Severity Dialog Box) > Finish Page</p> |

The following elements are included (unlabeled GUI elements are shown in angle brackets>):



| GUI Element (A-Z) | Description |
|-------------------------------------|--|
| Restrict results to CI types | <p>Restrict the results of the topology map to related CIs of one or more CI types.</p> <ul style="list-style-type: none"> ▶ Click  to select the required CI types. Opens the CI Type Selector dialog box. ▶ Click  to delete the value in the Restrict results to CI types box. |
| Restrict results to view | <p>Restrict the results of the topology map to related CIs from a specific view.</p> <ul style="list-style-type: none"> ▶ Click  to select the required view. Opens the Select View dialog box. ▶ Click  to delete the selected view in the Restrict results to view box. |
| Source CI | <p>Select the CI whose related CIs you want to display in an embedded topology map.</p> <ul style="list-style-type: none"> ▶ Click  to select the required CI and retrieve its object ID. Opens the Select Source CI dialog box. For details, see “View Explorer” on page 676. ▶ Click  to delete the value in the Source CI box. |

Direct Link Parameters – Show CI Properties Page

| | |
|------------------------------|--|
| Description | Enables you to view basic information for an existing CI. |
| Important Information | <ul style="list-style-type: none"> ▶ For general information about the Generate Direct Link wizard, see “Generate Direct Link Wizard” on page 415. ▶ Click Finish to close the wizard and create a URL. For details, see “Generate Direct Link Dialog Box” on page 414. |

| | |
|---------------------|--|
| Useful Links | “Configuration Item Properties Dialog Box” on page 53 |
| Wizard Map | <p>The Generate Direct Link wizard contains:</p> <p>Generate Direct Link Wizard ></p> <p>Select Command Page ></p> <p>(Direct Link Parameters – CI Type Selector Page) ></p> <p>(Direct Link Parameters – Show Change Report Page) ></p> <p>(Direct Link Parameters – Show Change Report on View Page) ></p> <p>(Direct Link Parameters – Show CI Neighborhood Page) ></p> <p>(Direct Link Parameters – Show CI Properties Page) ></p> <p>(Direct Link Parameters – Show Impact Map Page) ></p> <p>(Direct Link Parameters – Show Instances Grid Page) ></p> <p>(Direct Link Parameters – Show Related CIs Page) ></p> <p>(Direct Link Parameters – Show Topology Report Page) ></p> <p>(Direct Link Parameters – Show View Page) ></p> <p>(Direct Link Parameters – Show View Topology Page) ></p> <p>(Direct Link Parameters – Start in Mode Page) ></p> <p>(Select CIs Dialog Box) ></p> <p>(Correlation State and Trigger Severity Dialog Box) ></p> <p>Finish Page</p> |



The following elements are included (unlabeled GUI elements are shown in angle brackets>):

| GUI Element (A-Z) | Description |
|----------------------------|---|
| Source CI object ID | <p>Select the required CI.</p> <ul style="list-style-type: none"> ▶ Click  to select the source CI and retrieve its object ID. Opens the Select Source CI dialog box. For details, see “View Explorer” on page 676. ▶ Click  to delete the value in the Source CI object ID box. |

 **Direct Link Parameters – Show Impact Map Page**

| | |
|------------------------------|--|
| Description | <p>Enables you to run a Correlation rule defined in Correlation Manager.</p> <p>The URL you create enables you to embed a topology map showing a simulation of all the CIs that are affected by the selected trigger CI for the selected severity and state.</p> <p>For details, see “Run Correlation Dialog Box” on page 528.</p> |
| Important Information | <ul style="list-style-type: none"> ▶ For general information about the Generate Direct Link wizard, see “Generate Direct Link Wizard” on page 415. ▶ Click Finish to close the wizard and create a URL. For details, see “Generate Direct Link Dialog Box” on page 414. |
| Useful Links | <p>“Topology View Application” on page 515</p> |
| Wizard Map | <p>The Generate Direct Link wizard contains:</p> <p>Generate Direct Link Wizard > Select Command Page > (Direct Link Parameters – CI Type Selector Page) > (Direct Link Parameters – Show Change Report Page) > (Direct Link Parameters – Show Change Report on View Page) > (Direct Link Parameters – Show CI Neighborhood Page) > (Direct Link Parameters – Show CI Properties Page) > (Direct Link Parameters – Show Impact Map Page) > (Direct Link Parameters – Show Instances Grid Page) > (Direct Link Parameters – Show Related CIs Page) > (Direct Link Parameters – Show Topology Report Page) > (Direct Link Parameters – Show View Page) > (Direct Link Parameters – Show View Topology Page) > (Direct Link Parameters – Start in Mode Page) > (Select CIs Dialog Box) > (Correlation State and Trigger Severity Dialog Box) > Finish Page</p> |

The following elements are included (unlabeled GUI elements are shown in angle brackets>):



| GUI Element (A-Z) | Description |
|-----------------------------------|--|
| State and Trigger Severity | <ul style="list-style-type: none"> ▶ Click  to select the required severity and state. Opens the Correlation State and Trigger Severity dialog box. For details, see “Run Correlation Dialog Box” on page 528. ▶ Click  to delete the selected severity and state. |
| Trigger CIs | Click  to select the CIs that represent the simulated changes to be made to the system. Opens the Select CIs dialog box. For details, see “Select CIs Dialog Box” on page 437. |

Direct Link Parameters – Show Instances Grid Page

| | |
|------------------------------|--|
| Description | Display all of the CI instances found in the CMDB for selected CI type, and its children. |
| Important Information | <ul style="list-style-type: none"> ▶ For general information about the Generate Direct Link wizard, see “Generate Direct Link Wizard” on page 415. ▶ Click Finish to close the wizard and create a URL. For details, see “Generate Direct Link Dialog Box” on page 414. |

| | |
|---------------------|--|
| Useful Links | “Element Instances Dialog Box” on page 368 |
| Wizard Map | <p>The Generate Direct Link wizard contains:</p> <p>Generate Direct Link Wizard ></p> <p>Select Command Page ></p> <p>(Direct Link Parameters – CI Type Selector Page) ></p> <p>(Direct Link Parameters – Show Change Report Page) ></p> <p>(Direct Link Parameters – Show Change Report on View Page) ></p> <p>(Direct Link Parameters – Show CI Neighborhood Page) ></p> <p>(Direct Link Parameters – Show CI Properties Page) ></p> <p>(Direct Link Parameters – Show Impact Map Page) ></p> <p>(Direct Link Parameters – Show Instances Grid Page) ></p> <p>(Direct Link Parameters – Show Related CIs Page) ></p> <p>(Direct Link Parameters – Show Topology Report Page) ></p> <p>(Direct Link Parameters – Show View Page) ></p> <p>(Direct Link Parameters – Show View Topology Page) ></p> <p>(Direct Link Parameters – Start in Mode Page) ></p> <p>(Select CIs Dialog Box) ></p> <p>(Correlation State and Trigger Severity Dialog Box) ></p> <p>Finish Page</p> |



The following elements are included (unlabeled GUI elements are shown in angle brackets>):

| GUI Element (A-Z) | Description |
|--------------------------|--|
| CI type | <p>Select the required CI type.</p> <ul style="list-style-type: none"> ▶ Click  to select the required CI type. Opens the CI Type Selector dialog box. ▶ Click  to delete the CI type. |

 **Direct Link Parameters – Show Related CIs Page**

| | |
|------------------------------|--|
| Description | Enables you to create a URL to a topology map displaying the related CIs of the selected (source) CI. The topology map opens in either Topology view or IT Universe. |
| Important Information | <ul style="list-style-type: none"> ▶ For general information about the Generate Direct Link wizard, see “Generate Direct Link Wizard” on page 415. ▶ Click Finish to close the wizard and create a URL. For details, see “Generate Direct Link Dialog Box” on page 414. |
| Wizard Map | <p>The Generate Direct Link wizard contains:</p> <p>Generate Direct Link Wizard > Select Command Page > (Direct Link Parameters – CI Type Selector Page) > (Direct Link Parameters – Show Change Report Page) > (Direct Link Parameters – Show Change Report on View Page) > (Direct Link Parameters – Show CI Neighborhood Page) > (Direct Link Parameters – Show CI Properties Page) > (Direct Link Parameters – Show Impact Map Page) > (Direct Link Parameters – Show Instances Grid Page) > (Direct Link Parameters – Show Related CIs Page) > (Direct Link Parameters – Show Topology Report Page) > (Direct Link Parameters – Show View Page) > (Direct Link Parameters – Show View Topology Page) > (Direct Link Parameters – Start in Mode Page) > (Select CIs Dialog Box) > (Correlation State and Trigger Severity Dialog Box) > Finish Page</p> |

The following elements are included (unlabeled GUI elements are shown in angle brackets>):



| GUI Element (A-Z) | Description |
|----------------------------|--|
| Initial mode | Displays the related CIs in either Topology Map or IT Universe. |
| Source CI object ID | <p>The object ID of the source CI.</p> <p>Select the (source) CI whose related CIs you want to display in a topology map.</p> <ul style="list-style-type: none"> ▶ Click  to select the source CI and retrieve its object ID. Opens the Select Source CI dialog box. For details, see “View Explorer” on page 676. ▶ Click  to delete the value in the Source CI object ID box. |

Direct Link Parameters – Show Topology Report Page

| | |
|------------------------------|--|
| Description | Enables you to create a URL to a specific Topology report. |
| Important Information | <ul style="list-style-type: none"> ▶ For general information about the Generate Direct Link wizard, see “Generate Direct Link Wizard” on page 415. ▶ Click Finish to close the wizard and create a URL. For details, see “Generate Direct Link Dialog Box” on page 414. |

| | |
|---------------------|---|
| Useful Links | <ul style="list-style-type: none"> ➤ “Topology Report” on page 591 ➤ “Working in Reports” in <i>Reference Information</i> |
| Wizard Map | <p>The Generate Direct Link wizard contains:</p> <p>Generate Direct Link Wizard ></p> <p>Select Command Page ></p> <p>(Direct Link Parameters – CI Type Selector Page) ></p> <p>(Direct Link Parameters – Show Change Report Page) ></p> <p>(Direct Link Parameters – Show Change Report on View Page) ></p> <p>(Direct Link Parameters – Show CI Neighborhood Page) ></p> <p>(Direct Link Parameters – Show CI Properties Page) ></p> <p>(Direct Link Parameters – Show Impact Map Page) ></p> <p>(Direct Link Parameters – Show Instances Grid Page) ></p> <p>(Direct Link Parameters – Show Related CIs Page) ></p> <p>(Direct Link Parameters – Show Topology Report Page)</p> <p>></p> <p>(Direct Link Parameters – Show View Page) ></p> <p>(Direct Link Parameters – Show View Topology Page) ></p> <p>(Direct Link Parameters – Start in Mode Page) ></p> <p>(Select CIs Dialog Box) ></p> <p>(Correlation State and Trigger Severity Dialog Box) ></p> <p>Finish Page</p> |





The following elements are included (unlabeled GUI elements are shown in angle brackets>):

| GUI Element (A-Z) | Description |
|--------------------|---|
| Report name | <p>Select the required Topology report.</p> <ul style="list-style-type: none"> ➤ Click  to select the required Topology report. Opens the Reports Tree dialog box. ➤ Click  to delete the value that appears in the Report name box. |

 **Direct Link Parameters – Show View Page**

| | |
|------------------------------|---|
| Description | <p>Enables you to create a URL to a specific view and optionally select a specific node in that view. When the view opens, the CI you chose is selected in the view.</p> <p>Note: The view opens in either Topology view or IT Universe.</p> |
| Important Information | <ul style="list-style-type: none"> ▶ For general information about the Generate Direct Link wizard, see “Generate Direct Link Wizard” on page 415. ▶ Click Finish to close the wizard and create a URL. For details, see “Generate Direct Link Dialog Box” on page 414. |
| Wizard Map | <p>The Generate Direct Link wizard contains:</p> <p>Generate Direct Link Wizard > Select Command Page > (Direct Link Parameters – CI Type Selector Page) > (Direct Link Parameters – Show Change Report Page) > (Direct Link Parameters – Show Change Report on View Page) > (Direct Link Parameters – Show CI Neighborhood Page) > (Direct Link Parameters – Show CI Properties Page) > (Direct Link Parameters – Show Impact Map Page) > (Direct Link Parameters – Show Instances Grid Page) > (Direct Link Parameters – Show Related CIs Page) > (Direct Link Parameters – Show Topology Report Page) > (Direct Link Parameters – Show View Page) > (Direct Link Parameters – Show View Topology Page) > (Direct Link Parameters – Start in Mode Page) > (Select CIs Dialog Box) > (Correlation State and Trigger Severity Dialog Box) > Finish Page</p> |



The following elements are included (unlabeled GUI elements are shown in angle brackets):

| GUI Element (A-Z) | Description |
|-----------------------------------|---|
| <Left pane> | A graphic illustration of the selected option. |
| Initial mode | Displays the view in either Topology Map or IT Universe. |
| Selected View | <p>The target view to be opened by the URL.</p> <ul style="list-style-type: none"> ▶ Click  to select the target view to be opened by the URL. Opens the Select View dialog box. ▶ Click  to delete the selected view in the Selected view box. |
| Select CI from view result | <p>(Optional) Click to select a CI and retrieve its object ID. When the view opens, the CI you chose is selected in the view.</p> <ul style="list-style-type: none"> ▶ Click  to choose the CI you want selected in the target view and retrieve its object ID. Opens the Select Source CI dialog box. For details, see “View Explorer” on page 676. ▶ Click  to delete the object ID for the selected CI in the Select CI from view result box. |
| View mode | <p>The view options are:</p> <ul style="list-style-type: none"> ▶ View Topology. Displays an entire layer within a view. ▶ Related in View. Displays the selected CI and its immediate neighbors within the current view. ▶ Related in DB. Displays the selected CI and its immediate neighbors in the CMDB. |

Direct Link Parameters – Show View Topology Page

| | |
|------------------------------|--|
| Description | Enables you to display the topology map of the selected view and embed it in an external application. |
| Important Information | <ul style="list-style-type: none"> ▶ For general information about the Generate Direct Link wizard, see “Generate Direct Link Wizard” on page 415. ▶ Click Finish to close the wizard and create a URL. For details, see “Generate Direct Link Dialog Box” on page 414. |
| Wizard Map | <p>The Generate Direct Link wizard contains:</p> <p>Generate Direct Link Wizard > Select Command Page > (Direct Link Parameters – CI Type Selector Page) > (Direct Link Parameters – Show Change Report Page) > (Direct Link Parameters – Show Change Report on View Page) > (Direct Link Parameters – Show CI Neighborhood Page) > (Direct Link Parameters – Show CI Properties Page) > (Direct Link Parameters – Show Impact Map Page) > (Direct Link Parameters – Show Instances Grid Page) > (Direct Link Parameters – Show Related CIs Page) > (Direct Link Parameters – Show Topology Report Page) > (Direct Link Parameters – Show View Page) > (Direct Link Parameters – Show View Topology Page) > (Direct Link Parameters – Start in Mode Page) > (Select CIs Dialog Box) > (Correlation State and Trigger Severity Dialog Box) > Finish Page</p> |

The following elements are included (unlabeled GUI elements are shown in angle brackets>):

| GUI Element (A-Z) | Description |
|----------------------|--|
| Selected View | <ul style="list-style-type: none"> ▶ Click  to select the required view to be opened by the URL. Opens the Select View dialog box. ▶ Click  to delete the selected view in the Selected view box. |

Direct Link Parameters – Start in Mode Page

| | |
|------------------------------|--|
| Description | Starts the UCMDB application at the selected page, for example, at the Modeling Studio page. |
| Important Information | <ul style="list-style-type: none"> ▶ For general information about the Generate Direct Link wizard, see “Generate Direct Link Wizard” on page 415. ▶ Click Finish to close the wizard and create a URL. For details, see “Generate Direct Link Dialog Box” on page 414. |
| Wizard Map | <p>The Generate Direct Link wizard contains:</p> <p>Generate Direct Link Wizard > Select Command Page > (Direct Link Parameters – CI Type Selector Page) > (Direct Link Parameters – Show Change Report Page) > (Direct Link Parameters – Show Change Report on View Page) > (Direct Link Parameters – Show CI Neighborhood Page) > (Direct Link Parameters – Show CI Properties Page) > (Direct Link Parameters – Show Impact Map Page) > (Direct Link Parameters – Show Instances Grid Page) > (Direct Link Parameters – Show Related CIs Page) > (Direct Link Parameters – Show Topology Report Page) > (Direct Link Parameters – Show View Page) > (Direct Link Parameters – Show View Topology Page) > (Direct Link Parameters – Start in Mode Page) > (Select CIs Dialog Box) > (Correlation State and Trigger Severity Dialog Box) > Finish Page</p> |



The following elements are included (unlabeled GUI elements are shown in angle brackets):

| GUI Element (A-Z) | Description |
|---------------------|--|
| <Left pane> | A graphic illustration of the selected mode. |
| Initial mode | Starts the UCMDB application in the selected mode. |

 **Select CIs Dialog Box**

| | |
|------------------------------|--|
| Description | Enables you to select the required CIs. |
| Important Information | <ul style="list-style-type: none"> ▶ For general information about the Generate Direct Link wizard, see “Generate Direct Link Wizard” on page 415. ▶ Click Finish to close the wizard and create a URL. For details, see “Generate Direct Link Dialog Box” on page 414. ▶ For details on the CI Selector, see “View Explorer” on page 676. |
| Wizard Map | <p>The Generate Direct Link wizard contains:</p> <p>Generate Direct Link Wizard > Select Command Page > (Direct Link Parameters – CI Type Selector Page) > (Direct Link Parameters – Show Change Report Page) > (Direct Link Parameters – Show Change Report on View Page) > (Direct Link Parameters – Show CI Neighborhood Page) > (Direct Link Parameters – Show CI Properties Page) > (Direct Link Parameters – Show Impact Map Page) > (Direct Link Parameters – Show Instances Grid Page) > (Direct Link Parameters – Show Related CIs Page) > (Direct Link Parameters – Show Topology Report Page) > (Direct Link Parameters – Show View Page) > (Direct Link Parameters – Show View Topology Page) > (Direct Link Parameters – Start in Mode Page) > (Select CIs Dialog Box) > (Correlation State and Trigger Severity Dialog Box) > Finish Page</p> |

The following elements are included (unlabeled GUI elements are shown in angle brackets>):

| GUI Element (A-Z) | Description |
|---|---|
|  | Moves the selected CI in the CI Selector pane to the Trigger CIs pane. |
|  | Moves the selected CI in the Trigger CIs pane to the CI Selector pane. |
|  | Moves all the CIs in the Trigger CIs pane to the CI Selector pane. |
| CI Selector pane | <p>Enables you to choose the CIs to be used as the trigger in an impact map.</p> <ul style="list-style-type: none"> ▶ Select the Browse Views tab to search for and display a view, and browse through the view to locate a particular CI. ▶ Select the Search CIs tab to search for and display a view, and browse through the view to locate a particular CI. <p>For details on how to use the CI Selector pane, see “View Explorer” on page 676.</p> |
| Trigger CIs pane | The CIs that are used as the triggers in an impact map. |

Correlation State and Trigger Severity Dialog Box

| | |
|---------------------------|---|
| <p>Description</p> | <p>Enables you to select the required severity and state to display in the requested impact map. For details, see the “Run Correlation Dialog Box” on page 528.</p> <p>To access:</p> <ul style="list-style-type: none"> ▶ From the Direct Links wizard: Select Admin > Modeling > <TQL editor> > Edit > Direct Links Wizard > Select command > Embedded links > Show impact map. Next, click the Edit button  in the State and Trigger Severity box. ▶ From the Show CI Instances report: Select Application > Overview Reports. Select the relevant report and drill down to the Show CI Instances report. In the report, select Display Label. Right-click a node and select Show Impact Map. |
| <p>Wizard Map</p> | <p>The Generate Direct Link wizard contains:</p> <p>Generate Direct Link Wizard > > (Direct Link Parameters – CI Type Selector Page) > (Direct Link Parameters – Show Change Report Page) > (Direct Link Parameters – Show Change Report on View Page) > (Direct Link Parameters – Show CI Neighborhood Page) > (Direct Link Parameters – Show CI Properties Page) > (Direct Link Parameters – Show Impact Map Page) > (Direct Link Parameters – Show Instances Grid Page) > (Direct Link Parameters – Show Related CIs Page) > (Direct Link Parameters – Show Topology Report Page) > (Direct Link Parameters – Show View Page) > (Direct Link Parameters – Show View Topology Page) > (Direct Link Parameters – Start in Mode Page) > (Select CIs Dialog Box) > (Correlation State and Trigger Severity Dialog Box) > Finish Page</p> |

The following elements are included (unlabeled GUI elements are shown in angle brackets>):

| GUI Element (A-Z) | Description |
|-------------------------------------|--|
| Correlation State | Select the required State. For details about States, see “State Manager” on page 499. |
| Correlation Trigger Severity | <p>Select the required severity.</p> <p>Note: The severity list was defined for the state in the System Type Manager. For details, see “System Type Manager” on page 320.</p> <p>For example, you can create a Correlation rule in the Correlation Manager (see the “Correlation Definition Dialog Box” on page 187), that defines the severity of the trigger node as other than No Change. If you select a severity other than No Change, for example, Plan, the condition is met and the simulated changes in the system are triggered.</p> |

Finish Page

| | |
|--------------------|---|
| Description | This is the final page of the Generate Direct Link wizard. Click Finish to close the wizard and create a URL. Opens the Generate Direct Link dialog box. |
|--------------------|---|

| | |
|------------------------------|--|
| Important Information | For general information about the Generate Direct Link wizard, see “Generate Direct Link Wizard” on page 415. |
| Wizard Map | <p>The Generate Direct Link wizard contains:</p> <p>Generate Direct Link Wizard > Select Command Page > (Direct Link Parameters – CI Type Selector Page) > (Direct Link Parameters – Show Change Report Page) > (Direct Link Parameters – Show Change Report on View Page) > (Direct Link Parameters – Show CI Neighborhood Page) > (Direct Link Parameters – Show CI Properties Page) > (Direct Link Parameters – Show Impact Map Page) > (Direct Link Parameters – Show Instances Grid Page) > (Direct Link Parameters – Show Related CIs Page) > (Direct Link Parameters – Show Topology Report Page) > (Direct Link Parameters – Show View Page) > (Direct Link Parameters – Show View Topology Page) > (Direct Link Parameters – Start in Mode Page) > (Select CIs Dialog Box) > (Correlation State and Trigger Severity Dialog Box) > Finish Page</p> |

13

Exporting the UCMDB Class Model to a UML Tool

This chapter includes the main concepts, tasks, and reference information for exporting the HP Universal CMDB class model to a Unified Modeling Language (UML) tool.

Note: Currently, Altova UModel versions 2008 and 2009 are supported.

This chapter includes:

Concepts

- Export to UML Tool – Overview on page 444

Tasks

- Export the Class Model on page 444
- Convert XML of Selected Part of Class Model on page 445

Reference

- Tool Plug-in Input on page 447
- Exporting the Class Model to a UML Tool User Interface on page 448

Export to UML Tool – Overview

The Export to UML tool enables you to export selected sections of the UCMDDB class model to a format compatible with UML tools, and to view the model as a UML diagram.

The input for the tool is the UCMDDB class model XML file retrieved by the JMX service **Topaz/service=CMDB Class Model Services/exportClassModelToXml()** for UCMDDB 8.x.

Export the Class Model

This task describes how to use the Export Class Model to UML tool wizard.

This task includes the following steps:

- “Prerequisites” on page 444
- “Run the UML Tool” on page 444
- “View the Exported File in Altova” on page 445

1 Prerequisites

Set up the tool by extracting **ExportToUML.zip** to any location. The file is located in the following directory:

```
<Volume>:\hp\UCMDDB\UCMDDBServer\j2f\tools
```

2 Run the UML Tool

You use the Export Class Model to UML wizard to choose the CIT and its attributes to be exported to the UML tool.

For details on working with the Export to UML wizard, see “Export Class Model to UML Wizard” on page 448.

3 View the Exported File in Altova

- a In Altova, select **File > Import From XMI File**.
- b Select the XMI file. The class model entry appears in the Model Tree pane.
- c Right-click the entry and select **Show in new diagram > Content**. Click **OK**.

Convert XML of Selected Part of Class Model

This task describes how to use the custom plug-in to convert the XML of a selected part of the class model to the UML tool format.

The plug-in can be either a Java class or an XSLT text file. If you use a Java class, it must implement the **ITransformToUML(ExportToUML.jar)** interface; the **transformToUML()** method receives an XML string as a parameter and returns a byte array that is written to the output file.

For details on the custom plug-in input, see “Tool Plug-in Input” on page 447.

This task includes the following steps:

- “Activate the Plug-in Using a Java Class” on page 445
- “Activate the Plug-in Using an XSLT Text File” on page 446

Activate the Plug-in Using a Java Class

Add the display name and fully-qualified class name to the **config.xml** file in the **ExportToUML** directory, as follows:

```
<ConverterToUML>
  <Name><display name></Name>
  <Class><fully qualified class name></Class>
</ConverterToUML>
```

Continue with the procedure for exporting the class model. For details, see “Export the Class Model” on page 444.

Activate the Plug-in Using an XSLT Text File

In this case, XSLT from the specified file is applied to the class model XML and is written to the output file.

Add the display name and full path of the XSLT file to the **config.xml** file in the ExportToUML directory, as follows:

```
<ConverterToUML>  
  <Name><display name></Name>  
  <XsltFile><Full_path_of_the_XSLT_file></XsltFile>  
</ConverterToUML>
```

Continue with the procedure for exporting the class model. For details, see “Export the Class Model” on page 444.

Tool Plug-in Input

The input for the plug-in is an XML string (selected classes/attributes/valid links) in the following form:

```
<?xml version="1.0" encoding="ISO-8859-1"?>
<Class-Model>
  <Class class-name="hostresource" display-name="Host Resource"
visibility="public">
    <Attribute name="isvirtual" display-name="Is Virtual" visibility="public"/>
    <Attribute name="city" display-name="City" visibility="public"/>
  </Class>
  <Class class-name="host_node" display-name="Computer" visibility="public">
    <Derived-From class-name="host"/>
  </Class>
  <Class class-name="vax" display-name="VAX" visibility="public">
    <Attribute name="root_actualdeletionperiod" display-name="Actual Deletion
Period" visibility="public"/>
    <Attribute name="data_allow_auto_discovery" display-name="Allow CI Update"
visibility="public"/>
    <Derived-From class-name="host_node"/>
  </Class>
  <Class class-name="host" display-name="Host" visibility="public">
    <Attribute name="host_iscomplete" display-name="Host Is Complete"
visibility="public"/>
    <Attribute name="host_isroute" display-name="Host Is Route" visibility="public"/>
    <Attribute name="host_hostname" display-name="Host Name" visibility="public"/>
    <Attribute name="host_os" display-name="Host Operating System"
visibility="public"/>
  </Class>
  <Class class-name="unix" display-name="Unix" visibility="public">
    <Derived-From class-name="host_node"/>
  </Class>
  <Valid-Link ID="host_member_host" display-name="Member" visibility="public">
    <End1 class-name="host"/>
    <End2 class-name="host"/>
  </Valid-Link>
  <Valid-Link ID="host_container_f_hostresource" display-name="Container link"
visibility="public">
    <End1 class-name="host"/>
    <End2 class-name="hostresource"/>
  </Valid-Link>
</Class-Model>
```

Exporting the Class Model to a UML Tool User Interface

This section describes:

- Export Class Model to UML Wizard on page 448

Export Class Model to UML Wizard

| | |
|------------------------------|--|
| Description | Enables you to choose the CIT and its attributes to be exported to the UML tool. To access: Browse to the location where you extracted the tool. Right-click ExportToUML.jar in the ExportToUML directory. Select Open With > Java 2 Platform SE binary . |
| Important Information | By default the tool opens the ClassModel.xml file in the ExportToUML directory. You open other files through the File > Open Class Model File menu. |
| Included in Tasks | “Export the Class Model” on page 444 |
| Wizard Map | The Export Class Model to UML wizard contains: Export Class Model to UML Wizard > Select Valid Links > Export Selected Items |
| Useful Links | “Tool Plug-in Input” on page 447 |

The following elements are included:

| GUI Element (A-Z) | Description |
|--------------------------|--|
| File | Displays a list of XML files. Open the file that contains the class model. |

| GUI Element (A-Z) | Description |
|-------------------------------|---|
| Select Attributes Pane | <p>Select the attributes to be displayed in the UML tool. The attributes of the selected CIT are displayed in this pane. The attributes are colored as follows:</p> <ul style="list-style-type: none"> ▶ Attributes inherited from the parent CIT are black. ▶ Attributes specific to this CIT are dark blue. |
| Select CI Types Pane | <p>The CITs displayed here are retrieved from the ClassModel.xml file.</p> <p>Select the CIT and its sub nodes to be exported to the UML tool.</p> <p>Use the buttons to select or clear all subindex.</p> |

Select Valid Links

| | |
|------------------------------|--|
| Description | <p>Enables you to select links that can be used between two CITs.</p> <p>To access: Click the Next button in the Export Class Model to UML wizard.</p> |
| Important Information | <p>General information about the wizard is available in “Export Class Model to UML Wizard” on page 448.</p> |
| Included in Tasks | <p>“Export the Class Model” on page 444</p> |
| Wizard Map | <p>The Export Class Model to UML wizard contains:</p> <p>Export Class Model to UML Wizard > Select Valid Links > Export Selected Items</p> |

The following elements are included (unlabeled GUI elements are shown in angle brackets>):

| GUI Element (A-Z) | Description |
|---|--|
| Filter by | Enables you to filter the list of valid links. You can filter the list of CITs and you can sort the list by CIT or relationship. |
|  | Click to remove the filter from the list of CITs. |

Export Selected Items

| | |
|------------------------------|---|
| Description | Enables you to export the selected CITs and their attributes to the UML tool. To access: Click the Next button in the Select Valid Links page. |
| Important Information | General information about the wizard is available in “Export Class Model to UML Wizard” on page 448. |
| Included in Tasks | “Export the Class Model” on page 444 |
| Wizard Map | The Export Class Model to UML wizard contains: Export Class Model to UML Wizard > Select Valid Links > Export Selected Items |

The following elements are included (unlabeled GUI elements are shown in angle brackets>):

| GUI Element (A-Z) | Description |
|-------------------|---|
| Export | Click to browse to the UML file, in XMI format, to which you want to add the UCMDB CITs and their attributes. If there are no valid links for a pair of CITs, a no valid links message is displayed in the Select Valid Links page. |

Part II

Settings

14

Infrastructure Settings Manager

This chapter provides information on the Infrastructure Settings Manager.

This chapter includes:

Concepts

- ▶ Infrastructure Settings Manager – Overview on page 453

Reference

- ▶ Infrastructure Settings Manager User Interface on page 454

Infrastructure Settings Manager – Overview

HP Universal CMDB enables you to define the value of many settings that determine how HP Universal CMDB and its applications run.

Important: Modifying certain settings can adversely affect the performance of HP Universal CMDB. It is highly recommended not to modify any settings without first consulting HP Software Support or your HP Services representative.

In the Infrastructure Settings Manager, you can select different contexts from which to view and edit settings. These contexts are split into two groups:

► **Applications**

This list includes those contexts that determine how the various applications running within HP Universal CMDB behave.

► **Foundations**

This list includes those contexts that determine how the administration tools of HP Universal CMDB run.

Descriptions of the individual settings appear in the **Description** column of the table on the Infrastructure Settings page.

Infrastructure Settings Manager User Interface

This section describes:

- Infrastructure Settings Manager Window on page 454
- Edit Setting Dialog Box on page 455

Infrastructure Settings Manager Window

| | |
|--------------------|---|
| Description | Enables you to view and edit infrastructure settings. To access: Select Admin > Settings > Infrastructure Settings Manager . |
|--------------------|---|

The following elements are included (unlabeled GUI elements are shown in angle brackets>):

| GUI Element (A-Z) | Description |
|---|--|
|  | Click the Edit Setting button to open the Edit Settings dialog box which enables you to edit an infrastructure setting. |
| All | Displays all the infrastructure settings. |
| Applications | Displays the infrastructure settings connected with the Applications. |
| Description | A description of the infrastructure setting. |
| Foundations | Displays the infrastructure settings connected with the Administration tools. |
| Name | The name of the infrastructure setting. |
| Value | The value of the infrastructure setting. |

Edit Setting Dialog Box

| | |
|--------------------|--|
| Description | Enables you to change the value of an infrastructure setting. To access: In Infrastructure Settings Manager, click the Edit Setting button  next to the infrastructure setting to be edited. |
|--------------------|--|

The following elements are included (unlabeled GUI elements are shown in angle brackets):

| GUI Element (A-Z) | Description |
|--------------------|--|
| Description | A description of the infrastructure setting. |
| Name | The name of the infrastructure setting. |
| Note | Other information about the selected infrastructure setting. |

| GUI Element (A-Z) | Description |
|------------------------|---|
| Restore Default | Click to restore the default value of the infrastructure setting. |
| Value | The value of the infrastructure setting. |

15

Package Manager

This chapter provides information on Package Manager.

This chapter includes:

Concepts

- ▶ Package Administration Overview on page 458
- ▶ Package Zip File Contents and Format on page 459
- ▶ Packages for Federated CMDB Adapters on page 460

Tasks

- ▶ Create a Custom Package on page 461
- ▶ Deploy a Package on page 462
- ▶ Export a Package on page 462

Reference

- ▶ Package Resources on page 462
- ▶ Using the JMX Console to Perform Package Manager Tasks on page 465
- ▶ Package Manager User Interface on page 469

Troubleshooting and Limitations on page 483

Package Administration Overview

A package is a subset of resources grouped together by a defined criteria. For a list of the predefined resource types, see “Resource Types” on page 474.

Package Manager fulfills several functions:

- ▶ Enables the discovery of specific IT infrastructure assets. For example, HP Universal CMDB deploys the SQL_Server package to discover Microsoft SQL servers.
- ▶ Enables you to define the CI Type model through the CI types that are included in the packages. For example, some of the CI types included in the package Host_Resources_Basic are Disk, CPU, Process, and Print Queue.
- ▶ Enables you to move groups of resources from one system to another. For example, from a test to a production environment.

There are two types of packages:

- ▶ **Factory package.** Contains resources that are deployed with the installation and are used to initialize HP Universal CMDB.

By default, factory packages are located in: **<HP Universal CMDB root folder>\UCMDBServer\root\lib\factory_packages.**

Note: Some of the factory packages that are deployed with the installation are not visible in the list of packages that appear in Package Manager. To display the hidden packages, right-click anywhere in the Package Manager Window and select **Show Hidden Packages.**

- ▶ **Custom package.** A package that is user created. You may want to create a custom package if the factory packages do not contain the resources needed for the tool you are developing, or if you want to export resources from system to system. For details, see “Create Custom Package/Edit Package Wizard” on page 470.

Important: If you create custom packages for the resources or tools you develop, do not place them in the <HP Universal CMDB root folder>\UCMDBServer\root\lib\factory_packages folder. This folder is only for factory packages.

Export and deployment of packages from system to system is performed through the Package Manager interface.

You can:

- ▶ Export some or all of a package's resources to your local directory. For details, see "Export a Package" on page 462.
- ▶ Deploy some or all of a package's resources to the CMDB from your local directory. For details, see "Deploy a Package" on page 462.

Package Zip File Contents and Format

A package's resources are stored in the CMDB. To export a package from system to system, you use the Package Manager interface (for details, see "Package Manager Window" on page 479). Package Manager creates a zip file containing the resources to enable the export of the resources.

When you export resources from the Package Manager to your local directory, the resource definitions are stored in various formats, for example, XML format.

In the sample **Network.zip** below, the **router.xml** file contains a Router CIT definition and the **Switch.xml** file contains a Switch CIT definition.

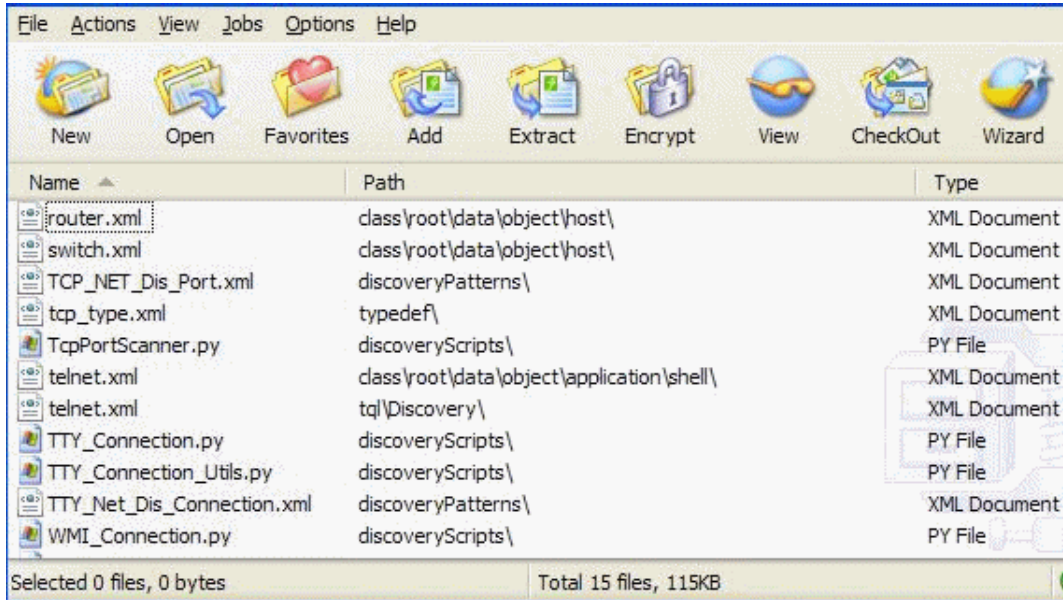

Packages for Federated CMDB Adapters

You deploy federated CMDB adapters by creating a package and placing them in the appropriate folder. For details, see “Deploy the Adapter” in *Integrations*.

Create a Custom Package

When you create a new package, you give the package a unique name and description, and then select the resources you want included in the package. For details, see “Create Custom Package/Edit Package Wizard” on page 470.

Example of Resources Selected to Be Included in a Package

The summary page in the Create Custom Package wizard displays the resources selected to be included in the package, as shown in the illustration below:

The package contains resources from the following resource groups:



- Relationships
- Valid Links
- Configuration Item Types

| Selection Summary |
|---|
| View the resources to be included in the package. |
| Relationships: applicationLink |
| Valid Links: Service Desk Link: Siebel Application -> IT Incident |
| Configuration Item Types: Business Service View |

Deploy a Package

You can deploy some or all of a package's resources to the CMDB from your local directory. For details, see "Package Manager Window" on page 479.

Example of Deploying Only Specific Resources in a Package

You want to deploy only some of the resources contained in the package called **ticket2.zip**. Click the  button to open the Deploy Packages to Server dialog box. Click the  button and select a package to deploy. In the lower pane of the dialog box, select the resources from the package you want to deploy.

Export a Package

You can export some or all of a package's resources to your local directory. For details, see "Package Manager Window" on page 479.

Example of Exporting Only Specific Resources in a Package

You want to export only some of the resources contained in a package called **ticket2.zip** to your local directory. Click the  button. In the Export Package dialog box, select the **Export Resources** option and select the resources you want to export.

Package Resources

This section contains a list of the resources a package can contain. For a list of the available resource types and their descriptions, see "Resource Types" on page 474.

- ▶ **acl**. The definition of a role such as Administrator or Guest. For details, see "Users and Roles" on page 639.
- ▶ **adapter**. Contains a description and the capabilities of the deployed federated adapter.

- ▶ **adapterCode.** Contains compiled classes (normally a jar), based-on *.jar files, and configuration files needed for federated adapters. Place these files in the **adapterCode**\<adapter ID> folder in the zip package. For details, see “Deploy the Adapter” in *Integrations*.
- ▶ **calculatedLinks subsystem.** Contains the calculated relationships and their triplets as defined in the CI Type Manager.
- ▶ **categories.** Contains the State definitions used by Correlation Manager. For details on States, see “State Manager” on page 499. For details on Correlation Manager, see “Correlation Manager” on page 177.
- ▶ **class.** CI type descriptions, such as host, file, switch, and so on. For details, see “CI Type Manager” on page 205.
- ▶ **correlation.** Correlation rule definitions. For details, see “Correlation Manager” on page 177.
- ▶ **datamodel.** Used to import CI instances into the system. If the CI does not exist in the CMDB, an instance of the CI is created. If a CI type already exists in the CMDB, the values of the CI from the package resource overwrites the values of the CI in the CMDB.
- ▶ **datamodelcreateonly.** Used to import CI instances into the system. If the CI does not exist in the CMDB, an instance of the CI is created. If a CI type already exists in the CMDB, the values of the CI from the package resource does not overwrite the values of the CI in the CMDB.
- ▶ **datamodelgenerateids.** Used to import CI instances into the system for CITs that require the ID to be calculated dynamically upon deployment (such as CITs with no key attributes).
- ▶ **discoveryConfigFiles.** Configuration files include properties and parameters that are needed to discover components on the system. For details, see “Manage Discovery Resources” in *Discovery and Dependency Mapping Guide*.
- ▶ **discoveryJobs.** A Discovery and Dependency Mapping (DDM) job includes configuration data, scheduling information, and TQL assignments needed to activate discovery of components. For details, see “Run Discovery” in *Discovery and Dependency Mapping Guide*.
- ▶ **discoveryModules.** A DDM module includes all the jobs needed to discover a specific component in the system. For details, see “Run Discovery” in *Discovery and Dependency Mapping Guide*.

- ▶ **discoveryPatterns.** DDM patterns define what scripts need to be run and in which order, declare the input and output CI Types and parameters to be configurable on the DDM jobs related to them. For details, see “Manage Discovery Resources” in *Discovery and Dependency Mapping Guide*.
- ▶ **discoveryResources.** External resources include all external resources that are needed in DDM, for example, a Visual Basic file, a credentials file, and so on. For details, see “Manage Discovery Resources” in *Discovery and Dependency Mapping Guide*.
- ▶ **discoveryScripts.** DDM scripts enable navigating to, and accessing, components that must be discovered. For details, see “Manage Discovery Resources” in *Discovery and Dependency Mapping Guide*.
- ▶ **discoveryWizard.** Used to define the Discovery Wizard dialog box contents. For details, see “Run Discovery” in *Discovery and Dependency Mapping Guide*.
- ▶ **enrichment.** Enrichment rule definitions. For details, see “Enrichment Manager” on page 297.
- ▶ **modelnotification.** Contains filter definitions for CMDB model notifications. The data model notification system gives notification of changes that occurred in the CMDB. For example, items in the CMDB that have been removed, updated, or added.
- ▶ **report.** Report rule definitions, as described in “Topology Report Manager” on page 245.
- ▶ **schedulerJobs.** Tasks that have been defined to run in the Scheduler. For details, see “Scheduler” on page 485.
- ▶ **tql.** TQL query definitions. For details, see “Query Manager” on page 283.
- ▶ **typedef.** Predefined Enumeration definitions that relate to attributes of type Enumeration, such as severity levels, admin states, and so on. For details, see “System Type Manager” on page 208.
- ▶ **users.** The definition of a user and the user’s role. For details, see “Security Manager User Interface” on page 654.
- ▶ **validlinks.** All predefined, valid connections (relationships) between CITs.
- ▶ **view.** View Manager definitions. For details, see “View Manager” on page 129.

Using the JMX Console to Perform Package Manager Tasks

This section describes the Package Manager tasks you can perform using the JMX console.

Note: It is recommended that you use the Package Manager to perform these tasks instead of the JMX console. View Package Deployment History cannot be performed by the Package Manager.

This section includes the following tasks:

- “Deploy a Package” on page 465
- “View Package Deployment History” on page 466
- “Undeploy a Package” on page 467
- “Display Currently Deployed Packages” on page 467
- “Export Packages” on page 468
- “Package Name Rules” on page 468

Deploy a Package

Follow these steps to deploy a package using the JMX console.

- a** Launch your Web browser and enter the following address:
http://<server_name>:8080/jmx-console, where <server_name> is the name of the machine on which HP Universal CMDB is installed.
- b** Under **MAM**, click **service=MAM Packaging Services** to open the JMX MBEAN View page.
- c** Locate **java.lang.String deployPackages**.
- d** In the **ParamValue** box for the parameter **customerId**, enter the <customer id>.

- e** In the **ParamValue** box for the parameter **dir**, enter the name of the folder that contains the package's zip file. Ensure that you include the full path to the folder.

Note: To deploy the package from the **factory_packages** directory, leave this box empty.

- f** In the **ParamValue** box for the parameter **packagesNames**, enter the name of the packages. For details, see "Package Name Rules" on page 468.
- g** Select **True** to override DDM job configurations changed in the DDM user interface. For details, see the *Discovery and Dependency Mapping Guide*.
- h** Click **Invoke** to deploy the package.

View Package Deployment History

Each time you deploy packages, a report is created displaying the deployment status of those packages. Use the JMX console to view the deployment status report.

- a** Launch the Web browser and navigate to:
http://<server_name>:8080/jmx-console, where **<server_name>** is the name of the machine on which HP Universal CMDB is installed.
- b** Under **MAM**, click **service=MAM Packaging Services** to open the JMX MBEAN View page.
- c** Locate **java.lang.String displayResourcesDeploymentHistory**.
- d** In the **ParamValue** box for the parameter **customerId**, enter the **<customer id>**.
- e** In the **ParamValue** box for the parameter **reportNum**, enter the number of the report you want to view.
- f** Click **Invoke** to view the deployment status report of the packages.

Undeploy a Package

Follow these steps to undeploy a package using the JMX console.

- a** Launch the Web browser and navigate to:
http://<server_name>:8080/jmx-console, where **<server_name>** is the name of the machine on which HP Universal CMDB is installed.
- b** Under **MAM**, click **service=MAM Packaging Services** to open the JMX MBEAN View page.
- c** Locate **java.lang.String undeployPackages**.
- d** In the **ParamValue** box for the parameter **customerId**, enter the **<customer id>**.
- e** In the **ParamValue** box for the parameter **packagesNames**, enter the name of the package you want to remove. For details, see “Package Name Rules” on page 468.
- f** Click **Invoke** to undeploy the package.

Display Currently Deployed Packages

Follow these steps to display currently deployed packages using the JMX console.

- a** Launch the Web browser and navigate to:
http://<server_name>:8080/jmx-console, where **<server_name>** is the name of the machine on which HP Universal CMDB is installed.
- b** Under **MAM**, click **service=MAM Packaging Services** to open the JMX MBEAN View page.
- c** Locate **java.lang.String displayDeployedPackages**.
- d** In the **ParamValue** box for the parameter **customerId**, enter the **<customer id>**.
- e** In the **ParamValue** box for the parameter **packagesNames**, specify the names of the packages you want to display. For details, see “Package Name Rules” on page 468.
- f** Click **Invoke** to display the packages that are currently deployed.

Export Packages

Follow these steps to export resources from the CMDB to the server on which HP Universal CMDB is installed using the JMX console.

- a** Launch the Web browser and navigate to:
http://<server_name>:8080/jmx-console, where **<server_name>** is the name of the machine on which HP Universal CMDB is installed.
- b** Under **MAM**, click **service=MAM Packaging Services** to open the JMX MBEAN View page.
- c** Locate **java.lang.String exportPackages**.
- d** In the **ParamValue** box for the parameter **customerId**, enter the **<customer id>**.
- e** In the **ParamValue** box for the parameter **packageName**, enter the name of the package you want to export. For details, see “Package Name Rules” on page 468.
- f** In the **ParamValue** box for the parameter **outputDir**, enter the name of the folder on the HP Universal CMDB server to which you want to export the package’s zip file. Ensure that you include the full path to the folder.
- g** In the **ParamValue** box for the parameter **userOnly**, select one of the following:
 - **True**. Export only the custom packages.
 - **False**. Export both custom and factory packages.
- h** Click **Invoke** to export the package.

Package Name Rules

The rules for entering a package name are as follows:

- Wildcard characters (*) are not supported.
- The package name is case sensitive.
- The package name must have a **.zip** extension.
- When deploying more than one package, separate the package names by commas.

Package Manager User Interface

This section describes:

- Choose Resources to Export Dialog Box on page 469
- Create Custom Package/Edit Package Wizard on page 470
- Export Package Dialog Box on page 476
- Filter Dialog Box on page 477
- Find Dialog Box on page 478
- Package Manager Window on page 479
- Undeploy Package Resource Wizard on page 481



Choose Resources to Export Dialog Box

| | |
|--------------------|--|
| Description | Select the resources you want to export to your local directory. To access: Select Export resources in the Export Package dialog box. |
|--------------------|--|

The following elements are included (unlabeled GUI elements are shown in angle brackets):

| GUI Element (A-Z) | Description |
|----------------------|---|
| <List of resources > | Displays the list of resources contained in the package. Select the resources you want to export to your local directory. |

Create Custom Package/Edit Package Wizard

| | |
|--------------------------|--|
| Description | Enables you to create a package using existing resources or edit an existing package. To access: Click the Add  button in the Package Manager window to create a new package or select a package in the Package Manager window and click the Edit  button to edit an existing package. |
| Included in Tasks | “Create a Custom Package” on page 461 |
| Wizard Map | The Create Custom Package Wizard contains: Package Properties Page > Resource Selection Page > Selection Summary Page |

Package Properties Page

| | |
|--------------------|--|
| Description | Define the properties of the package. |
| Wizard Map | The Create Custom Package/Edit Package Wizard contains: Package Properties Page > Resource Selection Page > Selection Summary Page |

The following elements are included (unlabeled GUI elements are shown in angle brackets>):

| GUI Element (A-Z) | Description |
|----------------------------|---|
| Package Category | A free text box for any notes you want to associate with the package. |
| Package Description | A description of the package. |
| Package Name | The name of the package. |

Resource Selection Page

| | |
|--------------------|--|
| Description | Enables you to add the required resources to the package. Select the required resources from the various resource types. Note: You can make multiple selections from each resource type. |
| Wizard Map | The Create Custom Package/Edit Package Wizard contains: Package Properties Page > Resource Selection Page > Selection Summary Page |

The following elements are included (unlabeled GUI elements are shown in angle brackets>):

| GUI Element (A-Z) | Description |
|-------------------|---|
| ✓ | Appears in the left pane. Indicates that a resource has been added to the package. |
| - | Appears in the left pane. Indicates that no resource has been added to the package. |

| GUI Element (A-Z) | Description |
|-----------------------------------|---|
| <Resource types in the left pane> | <p>Contains the resource types from which you can choose the required resources to add to the package.</p> <p>For details of a list of the available resource types and their descriptions, see “Resource Types” on page 474.</p> <p>Note: A green dot appears on the resource type icon when one or more of its resources are selected to be included in the package.</p> |

| GUI Element (A-Z) | Description |
|-------------------------------|---|
| <Resources in the right pane> | <p>Select the resources you want to add to the package. You can select multiple resources.</p> <p>Notes:</p> <ul style="list-style-type: none"> ▶ A green check appears to the right of a Configuration Item Types, Relationships, or Calculated Relationships when one or more of its children in the resource tree are included in the package. ▶ A folder's check box has a <input type="checkbox"/> when only some of its resources are included in the package. (This does not apply to Configuration Item Types, Relationships, or Calculated Relationships.) ▶ A folder's check box is selected when all its resources are included in the package. (This does not apply to Configuration Item Types, Relationships, or Calculated Relationships.) <p>Important information:</p> <p>If you want to add a calculated relationship to the package, you can choose to select either the required calculated relationship together with one or more of its triplets, or the required triplets without selecting the calculated relationship itself.</p> <ul style="list-style-type: none"> ▶ If you choose to select only specified triplets and not the calculated relationship, the triplets are added only if you already have an existing calculated relationship in the system. ▶ If you select a calculated relationship together with one or more of its triplets, then the property definitions of the calculated relationship you are adding, are included in the package. If you already have a calculated relationship in the system, then the property definitions of the existing calculated relationship are updated with the properties of the calculated relationship you are adding to the package. <p>For details on calculated relationships and triplets, see “Using Calculated Relationships” on page 407 and “Triplets Page” on page 232.</p> |

Resource Types

This section contains a list of the available resource types and their descriptions. For a list of the resources a package can contain, see “Package Resources” on page 462.

- ▶ **Calculated Relationships.** Contains the calculated relationships and their triplets as defined in the CI Type Manager.
- ▶ **Configuration Item Types.** The CITs defined in the CI Type Manager. For details, see “CI Types Overview” on page 206.
- ▶ **Correlations.** The Correlation rules defined in the Correlation Manager. For details, see “Correlation Manager” on page 177.
- ▶ **Discovery Configuration Files.** Configuration files include properties and parameters that are needed to discover components on the system. For details, see “Resource Files” in the *Discovery and Dependency Mapping Guide*.
- ▶ **Discovery External Resource.** Includes resources not used by the DDM Probe directly, but rather indirectly by the DDM scripts. It can contain binary executable files or DLLs, XML configuration files, or any other essential resource needed for the discovery to function properly. For details, see “Manage Discovery Resources” in the *Discovery and Dependency Mapping Guide*.
- ▶ **Discovery Jobs.** A DDM job includes configuration data, scheduling information, and TQL assignments needed to activate discovery of components. For details, see “Run Discovery” in the *Discovery and Dependency Mapping Guide*.
- ▶ **Discovery Jython Script.** DDM Jython Scripts are Jython scripts used by the discovery process to discover and map the various network entities.
- ▶ **Discovery Modules.** A DDM module includes all the jobs needed to discover a specific component on the system. For details, see “Discovery Modules Pane” in the *Discovery and Dependency Mapping Guide*.
- ▶ **Discovery Wizard Resource.** Used to define the Discovery Wizard dialog box contents. For details, see “Basic Mode Window” in the *Discovery and Dependency Mapping Guide*.

- **Discovery Patterns.** DDM patterns define what scripts need to be run and in which order, declare the input and output CI Types and the parameters to be configurable on the DDM jobs related to them. For details, see “Manage Discovery Resources” in the *Discovery and Dependency Mapping Guide*.
- **Enrichments.** The Enrichment rules defined in the Enrichment Manager. For details, see “Enrichment Manager” on page 297.
- **Job Scheduler.** Tasks that have been defined to run in the Scheduler. For details, see “Scheduler” on page 485.
- **Relationships.** The relationships defined in the CI Type Manager. For details, see “CI Type Relationships” on page 208.
- **Reports.** Report rules definitions, as described in “Topology Report Manager” on page 245.
- **State Categories.** The states defined in the State Manager. For details, see “State Manager” on page 499.
- **TQLs.** The TQL queries defined in the Query Manager. For details, see “Query Manager” on page 283.
- **Type Definitions.** Predefined Enumeration definitions that relate to attributes of enumeration type, such as severity levels, admin states, and so on. For details, see “System Type Manager” on page 208.
- **Users.** The definition of a user and the user’s role. For details, see “Security Manager User Interface” on page 654.
- **Valid Links.** All possible predefined valid connections (relationships) between the CITs that are defined in the CIT folder.
- **Views.** The views defined in the View Manager. For details, see “View Manager” on page 129.

Selection Summary Page

| | |
|--------------------|--|
| Description | Enables you to view the resources to be included in the package. |
| Wizard Map | The Create Custom Package/Edit Package Wizard contains: Package Properties Page > Resource Selection Page > Selection Summary Page |

The following elements are included (unlabeled GUI elements are shown in angle brackets):

| GUI Element (A-Z) | Description |
|----------------------|--|
| <Selected resources> | Displays the resources that were selected to be part of the package. |

Export Package Dialog Box

| | |
|------------------------------|--|
| Description | Exports the selected package's resources to your local directory. To access: Click the Export Package to Local Directory button  in the Package Manager window. |
| Important Information | You can choose to export some or all the resources in the package. |

The following elements are included (unlabeled GUI elements are shown in angle brackets):

| GUI Element (A-Z) | Description |
|----------------------------|---|
| Export to directory | Select the directory to which you want to export the resources. |
| Export resources | Export only some of the package's resources to your local directory. Opens the Choose Resources to Export dialog box. |

| GUI Element (A-Z) | Description |
|-----------------------------|---|
| Export whole package | Export all the resources in the package to your local directory. |
| File name | The name of the package. Note: The package name cannot be edited. |

Filter Dialog Box

| | |
|--------------------|--|
| Description | <p>Enables you to display only specific packages in the Package Manage window.</p> <p>A description of the filter condition you defined appears above the table columns in the Package Manager window. For example, the following illustration shows that a filter condition was created to display a package called Network.</p> <hr/> <p>Filter: Package Name[Equal Network];</p> <p>To access: Click the Filter  button in the Package Manager window.</p> |
|--------------------|--|

The following elements are included (unlabeled GUI elements are shown in angle brackets):

| GUI Element (A-Z) | Description |
|-------------------------------|---|
| <Click a column header> | For details, see “Customizing Columns” in <i>Reference Information</i> . |
| <Right-click a column header> | For details, see “Customizing Columns” in <i>Reference Information</i> . |
| Condition | Click inside the box and select the required operator. For details, see “Attribute Operator Definitions” on page 346. |

| GUI Element (A-Z) | Description |
|---------------------|--|
| Display Name | Filter the task list according to one of the following: <ul style="list-style-type: none"> ➤ Package name ➤ Package Category ➤ Package Description ➤ Readme For details, see “Package Manager Window” on page 479. |
| Value | Click inside the box to open the Edit box. Enter the required value. |

Find Dialog Box

| | |
|--------------------|--|
| Description | Find a package that contains a specified resource. For details, see “Resource Types” on page 474. To access: Click the Find  button in the Package Manager window. |
|--------------------|--|







The following elements are included (unlabeled GUI elements are shown in angle brackets>):











| GUI Element (A-Z) | Description |
|-----------------------|--|
| Case sensitive | Distinguish between uppercase and lowercase characters. When you select Case Sensitive , search results find only those instances in which the capitalization matches the text you typed in the Resource name box. |
| Resource name | Enter a word or phrase contained in the resource for which you are looking. |
| Search Results | The search results. Displays the names of the resources containing the text entered in the Resource name box. |
| Topic | The subsystem containing the resource you want the package to contain. For details, see “Resource Types” on page 474. |

Package Manager Window

| | |
|---------------------------|---|
| <p>Description</p> | <p>Package Manager enables you to:</p> <p>Create a package out of existing resources or edit an existing one to suit your IT management needs.</p> <p>To access: Select Admin > Settings > Package Manager.</p> |
|---------------------------|---|

The following elements are included (unlabeled GUI elements are shown in angle brackets>):

| GUI Element (A-Z) | Description |
|---|---|
|  | <p>Enables you to create a package out of existing resources. Opens the Create Custom Package Wizard.</p> |
|  | <p>Enables you to edit an existing package. Opens the Edit Package Wizard.</p> |
|  | <p>Deletes a package from the Package Manager while the resources from the package remain in the system. The package that is deleted is removed from the list of packages in the Package Manager window.</p> |
|  | <p>View the resources included in the selected package. Opens the View package resources window.</p> |
|  | <p>Deletes the resources from the system and removes them from the selected package. Opens the Undeploy Package Resource Wizard.</p> |
|  | <p>Deploys a package’s resources to the CMDB from your local directory. In the upper pane, click the  button to open the Deploy Packages to Server dialog box. Browse to the required package. The resources from that package appear in the lower pane of the dialog box. Select the resources that you want to deploy.</p> <p>Note: When deployment is finished and it is not successful, a Deploy Package window is displayed indicating which resources within the package are not successfully deployed.</p> |

| GUI Element (A-Z) | Description |
|---|--|
|  | Exports some or all of the package's resources to your local directory. Opens the Export Package dialog box. |
|  | Finds a package that contains a specified resource. Opens the Find dialog box. |
|  | <p>Generate a report displaying a list of the packages that are deployed in the system.</p> <p>Notes:</p> <ul style="list-style-type: none"> ▶ For information about limitations on the size of reports produced in .pdf format, see "Troubleshooting and Limitations" in <i>Reference Information</i>. ▶ For details on how to work with reports, see "Working in Reports - Overview" in <i>Reference Information</i>. |
|  | Update the contents of the table. |
|  | Opens the Filter dialog box. You use the Filter dialog box to show only the packages you want displayed in the Package Manager window. |
|  | Clear the filter definitions you created in the Filter dialog box. This is enabled only if filter definitions were created. |
|  | <p>Click the Customize Columns button to open the Select Columns dialog box and change the display order of the columns, hide a column, or display a hidden column.</p> <p>For details on the Select Columns dialog box, see "Select Columns Dialog Box" in <i>Reference Information</i>.</p> |
|  | Represents a factory package. |
|  | Represents a hidden package. |
|  | Represents a custom package. |
| Category | The free text you want to associate with the package, as displayed in the Package Properties page of the Create Custom Package Wizard. |

| GUI Element (A-Z) | Description |
|---------------------|--|
| Description | The description of the package, as displayed in the Package Properties page of the Create Custom Package Wizard. |
| Package Name | The name of the package. |
| Readme | Click to read a description of the package, as well as other relevant information. |

Undeploy Package Resource Wizard

| | |
|------------------------------|--|
| Description | Deletes the resources from the system and removes them from the selected package. To access: Click the Undeploy resources  button in the Package Manager window. |
| Important Information | When you undeploy a package, the resources are removed from the system, and from the other packages that contain that resource. You can restore the resources only when a package containing those resources is deployed. |
| Wizard Map | The Undeploy Package Resource Wizard contains: Remove Resources Page > Selection Summary Page |

Remove Resources Page

| | |
|------------------------------|---|
| Description | Select the resources you want to delete. |
| Important Information | If you delete all the resources from the package, the package is automatically deleted and removed from the list of packages in the Package Manager window. |
| Wizard Map | The Undeploy Package Resource Wizard contains: Remove Resources Page > Selection Summary Page |

The following elements are included (unlabeled GUI elements are shown in angle brackets):

| GUI Element (A-Z) | Description |
|---|---|
| <List of resources contained in the selected package> | Displays the resources contained in the selected package. |

 **Selection Summary Page**

| | |
|------------------------------|--|
| Description | Enables you to view the resources you selected to be deleted. |
| Important Information | When undeployment is finished and it is not successful, an Undeploy Package window is displayed indicating which resources within the package are not successfully undeployed. |
| Wizard Map | The Undeploy Package Resource Wizard contains: Remove Resources Page > Selection Summary Page |

The following elements are included (unlabeled GUI elements are shown in angle brackets):

| GUI Element (A-Z) | Description |
|-----------------------------|---|
| <List of deleted resources> | Displays the resources that were selected to be deleted from the package. |

Troubleshooting and Limitations

This section describes some of the troubleshooting issues that might arise when deploying and undeploying packages.

This section includes the following topics:

- “Gold Master Reports Cannot be Deployed by Package Manager” on page 483
- “Datamodel Resources Cannot Be Undeployed” on page 483
- “Additional Information on Package Deployment Failure” on page 483
- “Package Creation and Deployment in a Non-English Locale” on page 484

Gold Master Reports Cannot be Deployed by Package Manager

If you export a package’s resources from Package Manager that includes a Gold Master report definition, and then export those resources again to another system, the Gold Master report definition is not deployed.

Datamodel Resources Cannot Be Undeployed

For a list of the package resources, see “Package Resources” on page 462.

Additional Information on Package Deployment Failure

If package deployment fails, you can check the following Package Manager log files for additional information on why the deployment failure occurred.

- The **mam.packaging.log** file is located in: <HP Universal CMDB root directory>\UCMDBServer\j2f\log\mam.
- The **cmdb.classmodel.log** file is located in: <HP Universal CMDB root directory>\UCMDBServer\j2f\log\cmdb.
- The **mam.log** file is located in: <HP Universal CMDB root directory>\UCMDBServer\j2f\log\mam.
- The **cmdb.log** file is located in: <HP Universal CMDB root directory>\UCMDBServer\j2f\log\cmdb.

Note: If a `log\mam` or a `log\cmdb` folder does not exist, look for the log files under `log\EJBContainer`.

Package Creation and Deployment in a Non-English Locale

This section describes the limitations when working in a non-English locale.

- ▶ You cannot deploy a package if the server locale is different than the client locale and the package name contains non-English characters.
- ▶ You cannot create a package that contains resources (for example, views and TQLs) having non-English characters in their names, if the server locale is different from the client locale.

16

Scheduler

This chapter provides information on Scheduler.

This chapter includes:

Tasks

- Define Tasks that Are Activated on a Periodic Basis on page 485

Reference

- Cron Expressions on page 487
- Scheduler User Interface on page 488

Define Tasks that Are Activated on a Periodic Basis

This task describes how to run jobs on a periodic basis.

This section includes the following tasks:

- “Create a Job Definition” on page 485
- “Choose an Action” on page 486
- “Schedule a Task” on page 486

1 Create a Job Definition

Define a job definition. Add actions to the job you created and define how often they run. The Job Definition dialog box displays the tasks that are defined. For details, see “Job Definitions Dialog Box” on page 491.

Example of a Job Definition

The illustration below shows that two Enrichment rules are set to run — one at a set interval and one on a daily basis.

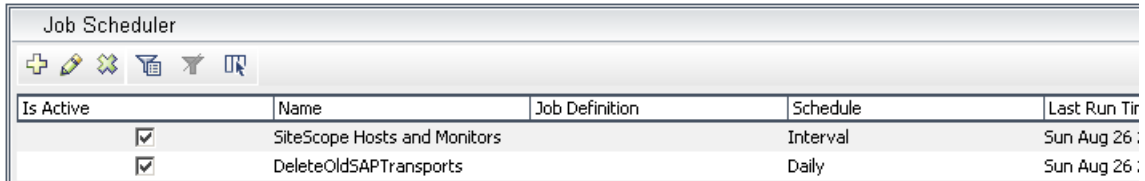

The screenshot shows a window titled "Job Scheduler" with a toolbar containing icons for adding, editing, deleting, and refreshing. Below the toolbar is a table with the following data:

| Is Active | Name | Job Definition | Schedule | Last Run Time |
|-------------------------------------|------------------------------|----------------|----------|---------------|
| <input checked="" type="checkbox"/> | SiteScope Hosts and Monitors | | Interval | Sun Aug 26 : |
| <input checked="" type="checkbox"/> | DeleteOldSAPTransports | | Daily | Sun Aug 26 : |

2 Choose an Action

Select the actions that you want the Scheduler to run. For details, see “Action Definition Dialog Box” on page 489.

3 Schedule a Task

Set the schedule for activating a task in the Scheduler pane. For details, see “Job Definitions Dialog Box” on page 491.

Example of a Scheduled Task

The illustration below shows that the Scheduler is set to take a snapshot of the View called **Host Resources** every day at 1:00 AM.

| Name | Action Definition |
|-----------------|-------------------|
| Save a snapshot | Host Resources |

Scheduler

Once
 Interval
 Daily
 Weekly
 Monthly
 Cron

Time zone:

Invocation hour:

Cron Expressions

A Cron Expression is a string composed of six or seven fields separated by white space. Six of the fields are mandatory, and one is optional.

The following table contains the fields used in a Cron Expression.

| Field Name | Allowed Values | Allowed Special Characters |
|--------------|-----------------|----------------------------|
| Seconds | 0-59 | , - * / |
| Minutes | 0-59 | , - * / |
| Hours | 0-23 | , - * / |
| Day of month | 1-31 | , - * ? / L W C |
| Month | 1-12 or JAN-DEC | , - * / |

| Field Name | Allowed Values | Allowed Special Characters |
|-----------------|------------------|----------------------------|
| Day of week | 1-7 or SUN-SAT | , - * ? / L C # |
| Year (optional) | empty, 1970-2099 | , - * / |

The following table contains examples of how to use Cron expressions.

| Cron Expression | Meaning |
|---------------------------------|--|
| <code>0 0 12 * * ?</code> | The task runs every Wednesday at 12:00 PM. |
| <code>0 15 10 ? * *</code> | The task runs at 10:15 AM every day. |
| <code>0 15 10 * * ? 2005</code> | The task runs at 10:15 AM every day during the year 2005. |
| <code>0 0/5 14 * * ?</code> | The task runs every 5 minutes starting at 2 PM and ending at 2:55 PM, every day. |
| <code>0 15 10 15 * ?</code> | The task runs at 10:15 AM on the 15th day of every month. |
| <code>0 15 10 ? * 6L</code> | The task runs at 10:15 AM on the last Friday of every month. |
| <code>0 15 10 ? * 6#3</code> | The task run at 10:15 AM on the third Friday of every month. |

For more details about Cron expressions, go to <http://quartz.sourceforge.net/javadoc/org/quartz/CronTrigger.html>.

Scheduler User Interface

This section describes:

- Action Definition Dialog Box on page 489
- Filter Dialog Box on page 490
- Job Definitions Dialog Box on page 491
- Job Scheduler Window on page 495

- Select Days Dialog Box on page 497
- Select Hours Dialog Box on page 497

Action Definition Dialog Box

| | |
|------------------------------|---|
| Description | Enables you to select a required action in a list of actions that can be run by the Scheduler. To access: Click the Add  button in the Actions pane in the Job Definition dialog box. |
| Important Information | After selecting the required action, click Next to display a list of actions. The list of action details depends on which action you choose. For example, if you select Run TQL , a list of the existing TQL queries appears. Select the required TQL query names. You can make multiple selections. |
| Included in Tasks | “Define Tasks that Are Activated on a Periodic Basis” on page 485 |

The following elements are included (unlabeled GUI elements are shown in angle brackets):

| GUI Element (A-Z) | Description |
|-------------------------------|--|
| <Click a column header> | For details, see “Customizing Columns” in <i>Reference Information</i> . |
| <Right-click a column header> | For details, see “Customizing Columns” in <i>Reference Information</i> . |
| Actions | For a list of actions that can be run by the Scheduler, see “Scheduler Actions” on page 490. |

Scheduler Actions

This section contains a list of actions that can be run by the Scheduler.

- ▶ **Rerun Discovery on View.** Runs a discovery on the CIs in a selected view. This enables you to configure a general discovery for the entire infrastructure on a less frequent basis, such as once a week, while updating the CIs in important views more frequently, for example, on a daily basis.
- ▶ **Run an Enrichment rule.** Activates the selected Enrichment rule according to its set schedule. Click **Next** to display a list of the available Enrichment rules and select the required ones. For details, see “Enrichment Manager” on page 297.
- ▶ **Run a Replication job.** You can set a schedule for running a replication job. A replication job contains all the information needed to federate data from an external data source. You can use this option only if a suitable data source has been defined. Click **Next** to display a list of replication jobs and select the required ones. For details, see “Replication Jobs Tab” in *Integrations*.
- ▶ **Run a TQL.** Run the selected TQL query according to its set schedule. Click **Next** to display a list of the available TQL queries and select the required ones. For details, see “Query Manager” on page 283.
- ▶ **Run a view.** Recalculate the selected view according to its set schedule. Click **Next** to display a list of the available views and select the required ones. For details, see “View Manager” on page 129.
- ▶ **Save a snapshot.** Save a snapshot of the selected view according to its set schedule. Click **Next** to display a list of the saved snapshots and select the required ones. For details, see “Compare Snapshots” on page 557.



Filter Dialog Box

| | |
|--------------------------|--|
| Description | Displays only specific tasks in the Job Scheduler window. To access: Click the Filter  button in the Job Scheduler window. |
| Included in Tasks | “Define Tasks that Are Activated on a Periodic Basis” on page 485 |

The following elements are included (unlabeled GUI elements are shown in angle brackets):

| GUI Element (A-Z) | Description |
|-------------------------------|--|
| <click a column header> | For details, see “Customizing Columns” in <i>Reference Information</i> . |
| <right-click a column header> | For details, see “Customizing Columns” in <i>Reference Information</i> . |
| Condition | Click inside the box and select the required operator. For details, see “Attribute Operator Definitions” on page 346. |
| Display Name | Filters the task list according to one of the following: <ul style="list-style-type: none"> ▶ Active ▶ Job Definition ▶ Last Run Time ▶ Name ▶ Next Run Time ▶ Schedule For details, see the Job Scheduler window. |
| Value | Click inside the box and either enter or select the required value. |

Job Definitions Dialog Box

| | |
|-------------------|---|
| Description | Enables you to add actions to the job you created and define how often they run. To access: <ul style="list-style-type: none"> ▶ Click the Add  button in the Job Scheduler window. ▶ Click the Add  button in the Schedule tab in the Replication Jobs window. |
| Included in Tasks | “Choose an Action” on page 486 “Schedule a Task” on page 486 |





The following elements are included (unlabeled GUI elements are shown in angle brackets>):

| GUI Element (A-Z) | Description |
|-----------------------|--|
| Job Definition | (Optional) A description for this job. |
| Name | The name of the job. |

Actions Pane

| | |
|--------------------------|--|
| Description | Enables you to add the required actions to the task you created. |
| Included in Tasks | “Choose an Action” on page 486 |



The following elements are included (unlabeled GUI elements are shown in angle brackets>):

| GUI Element (A-Z) | Description |
|---|--|
|  | Adds an action to the task. Opens the Action Definition dialog box. |
|  | Edits an existing action. |
|  | Deletes an action. |
|  | Moves a selected row up. |
|  | Moves a selected row down. |
| Action Definition | Displays the action details you selected in the Action Definition dialog box for the action added. |
| Name | Displays the name of the action that was added to the task. |

Scheduler Pane

| | |
|--------------------------|--|
| Description | Enables you to set the schedule for activating a task. |
| Included in Tasks | “Schedule a Task” on page 486 |
| Useful Links | “Cron Expressions” on page 487 |

The following elements are included (unlabeled GUI elements are shown in angle brackets>):

| GUI Element (A-Z) | Description |
|---|--|
|  | Automatically set the time zone to the correct one for the server. |
|  | Click to validate the Cron expression you entered. |
| Cron | Use a Cron expression to schedule a job. For a description of the fields used in Cron expressions and examples of how to use them, see “Cron Expressions” on page 487. |
| Cron Expression | Enter a Cron expression in the proper format. For a description of the fields used in Cron expressions and examples of how to use them, see “Cron Expressions” on page 487. |
| Daily | Runs a task on a daily basis. |
| Days of month | (Appears when you choose Monthly) Click the button  to the right of the Days of month box to choose the day of the month on which you want to run the action. Opens the Select Days dialog box. |
| Days of the week (Sunday - Saturday) | (Appears when you choose Weekly). Select the day or days on which you want the action to run. |



| GUI Element (A-Z) | Description |
|--|---|
| End by | <p>(Does not appear when you select Once) Choose the date and time when you want the action to stop running by selecting the End by check box and then clicking the down-arrow to the right of the box.</p> <p>Note: This step is optional. If you do not want to specify an ending date, leave the End by check box unselected.</p> |
| Interval | Activates the action at a set time interval. |
| Invocation Hour | <p>Choose the time to activate the action. Click the button  to the right of the Invocation Hour box to open the Select hours dialog box. For details, see the Select Hours dialog box.</p> <p>Note: You can enter the time manually in the Invocation hour box once you have chosen a time using the Select hours dialog box. You can assign more than one time. Each time is separated by a comma.</p> <p>The manually entered action times are not restricted to the hour and half hour only; they can be assigned any hour and minute combination. Use the 24:00 format.</p> <p>For example:</p> <p>11:15 AM is 11:15</p> <p>11:15 PM is 23:15</p> <p>Note: This box is only available when you want to schedule a task to run on a daily, weekly, or monthly basis.</p> |
| Invocation Time | (Appears when you choose Once) Choose the date and time you want the action to begin running by clicking the down-arrow to the right of the box. |
| Monthly | Runs a task on a monthly basis. |
| Months of the year (January - December) | (Appears when you choose Monthly). Select the month or months in which you want the action to run. |
| Once | Activates the task only once. |





| GUI Element (A-Z) | Description |
|---------------------|---|
| Repeat every | (Appears only when you select Interval) Type a value for the interval between successive runs and then choose the required unit of time measurement (seconds, minutes, hours, or days). |
| Start at | (Does not appear when you select Once) Choose the date and time when you want the action to begin running by selecting the Start at check box and then clicking the down-arrow to the right of the box. Note: This step is optional. If you do not want to specify a beginning time, leave the Start at check box unselected. |
| Time Zone | Set the required time zone. |
| Weekly | Runs a task on a weekly basis. |

Job Scheduler Window

| | |
|--------------------------|--|
| Description | Enables you to define tasks that are activated on a periodic basis. For example, you can define a task that generates a Topology report on a daily basis at 3:00 PM. Or you can define a schedule for taking snapshots of a specific view on a daily basis. To access: Click Admin > Settings > Scheduler . |
| Included in Tasks | “Define Tasks that Are Activated on a Periodic Basis” on page 485 |

The following elements are included (unlabeled GUI elements are shown in angle brackets>):

| GUI Element (A-Z) | Description |
|---|--|
|  | Creates and schedules a task. Opens the Job Definition dialog box. |
|  | Edits a task. Opens the Job Definition dialog box. |

| GUI Element (A-Z) | Description |
|---|--|
|  | Deletes a task. |
|  | Opens the Filter dialog box. You use the Filter dialog box to show only the scheduled jobs you want displayed in the Job Scheduler window. |
|  | Clears the filter definitions you created in the Filter dialog box. |
|  | Changes the display order of the columns, hide a column, or displays a hidden column. Opens the Columns dialog box. For details, see “Select Columns Dialog Box” in <i>Reference Information</i> . |
| <Click a column header> | For details, see “Customizing Columns” in <i>Reference Information</i> . |
| <Right-click a column header> | For details, see “Customizing Columns” in <i>Reference Information</i> . |
| Active | Select the check box to activate the scheduled job. |
| Job Definition | A description of the scheduled job as defined in the Definitions box in the Job Definition dialog box. |
| Last Run Time | The last time the job was run. |
| Name | The name of the scheduled job. |
| Next Run Time | The next time the job is scheduled to run. |
| Schedule | How often the job is scheduled to run. For details, see the “Scheduler Pane” on page 493. |

Select Days Dialog Box

| | |
|--------------------------|--|
| Description | Enables you to choose the day on which to activate the action. To access: Click Monthly in the Job Definition dialog box, and then click the  button to the right of the Days of month box. |
| Included in Tasks | “Define Tasks that Are Activated on a Periodic Basis” on page 485 |

The following elements are included (unlabeled GUI elements are shown in angle brackets):

| GUI Element (A-Z) | Description |
|--------------------------|---|
| <List of days from 1-31> | Choose the required days by selecting the required check boxes. You can select multiple days. The selected days appear in the Days of month box. For details, see Scheduler pane in the Job Definitions dialog box. |

Select Hours Dialog Box

| | |
|--------------------------|--|
| Description | Enables you to choose the time at which to activate the action. To access: Click Daily, Weekly, or Monthly , and then click the button  to the right of the Invocation hour box in the Job Definition dialog box. |
| Included in Tasks | “Define Tasks that Are Activated on a Periodic Basis” on page 485 |

The following elements are included (unlabeled GUI elements are shown in angle brackets>):

| GUI Element (A-Z) | Description |
|--|---|
| List of times by the hour and half hour | Choose all the required times by selecting the required check box. You can select multiple times. The selected hours appear in the Invocation hour box. For details, see “Invocation Hour” on page 494. |

17

State Manager

This chapter provides information on State Manager.

This chapter includes:

Concepts

- ▶ State Manager Overview on page 499

Tasks

- ▶ Define an Attribute State on page 500

Reference

- ▶ State Manager User Interface on page 500

State Manager Overview

A state is based on an Enumeration definition, which is a severity list.

State Manager contains two default states — Change and Operation. Each one is based on its own severity list. States are necessary for retrieving Correlation results in Topology View Application. For details, see “Topology View Application” on page 515.

To retrieve Correlation results, you must create a Correlation rule in Correlation Manager. A Correlation rule is based on a state that exists in State Manager. For details, see “Correlation Manager” on page 177.

You can use a default state, or if required, create one based on a severity list (Enumeration definition) that is more relevant to your needs. For details on creating Enumeration definitions, see “Create/Update List/Enumeration Definition Dialog Box” on page 240.

Note: It is not recommended to define states without first consulting HP Software Support.

Define an Attribute State

Enter a unique name and description for the state. Then select an Enumeration definition that can be used to define an attribute type. The Type Definition list displays the Enumeration definitions that are defined in System Type Manager. For details, see “System Type Manager Dialog Box” on page 243.

You can also click the **New Enumeration** button to create a new Enumeration definition. For details, see “State Manager Dialog Box” on page 501.

Alternatively, you can create an Enumeration definition in System Type Manager. The Enumeration definition you create in System Type Manager appears in State Manager.

State Manager User Interface



This section describes:

- ▶ State Manager Dialog Box on page 501

State Manager Dialog Box

| | |
|------------------------------|---|
| Description | Enables you to create a state based on a severity list (Enumeration definition). To access: Admin > Settings > State Manager. |
| Important Information | <ul style="list-style-type: none"> ▶ The Change and Operation states are default states that cannot be edited. ▶ It is recommended to consult with HP Software Support before defining a state. |
| Included in Tasks | “Define an Attribute State” on page 500 |
| Useful Links | “Enumeration Definition – Workflow” on page 214 |

The following elements are included (unlabeled GUI elements are shown in angle brackets>):

| GUI Element (A-Z) | Description |
|---|--|
|  | Add an attribute state. |
|  | Delete an attribute state. |
|  | Creates an Enumeration definition. Opens the Create Enumeration Definition dialog box. For details, see “Create/Update List/Enumeration Definition Dialog Box” on page 240. The Enumeration definition you have created appears in the System Type Manager dialog box, where you can edit it if required (for details, see “System Type Manager” on page 208). |
| Description | (Optional) Click in the row and enter a description of the state. |

| GUI Element (A-Z) | Description |
|------------------------|--|
| Name | Click in the row and enter a unique name for the state. |
| Type Definition | <p>Click in the box to display a list of the Enumeration definitions that can be used to define an attribute type. Select the required Enumeration definition or create one that is more relevant to your needs.</p> <p>Note: The Type Definition list only displays the Enumeration definitions (and not List definitions) that are defined in the System Type Manager.</p> |

18

Report Schedule Manager

This chapter provides information on the Report Schedule Manager.

This chapter includes:

Concepts

- ▶ Report Schedule Manager — Overview on page 503

Reference

- ▶ Report Schedule Manager User Interface on page 504

Report Schedule Manager — Overview

A user with Administrator permissions can edit, delete, resume, or pause scheduled reports in the Report Schedule Manager. You schedule Favorite Filters in the Report Manager to enable specific recipients to automatically receive the specified report, through email, at regularly defined intervals. For details, see “Create a Schedule” on page 604.

Report Schedule Manager User Interface





This section describes:



- Report Schedule Manager Main Page on page 504

Report Schedule Manager Main Page

| | |
|------------------------------|---|
| Description | Enables you to manage schedules configured on favorite filters in the Report Manager. To access: Select Admin > Settings > Report Schedule Manager |
| Important Information | You cannot create a new schedule from the Report Schedule Manager main page. For details on creating schedules, see “Create a Schedule” on page 604. |
| Included in Tasks | “Create a Schedule” on page 604. |

The following elements are included (unlabeled GUI elements are shown in angle brackets>):

| GUI Element (A–Z) | Description |
|---|--|
|  | Click to open the Edit Schedule for the <Report Name> dialog box and edit the selected schedule. For details, see “Create New Schedule Dialog Box” on page 613. Note: This dialog box enables you only to edit an existing schedule - you create a new schedule from the Report Manager interface. For details, see “Create a Schedule” on page 604. |
|  | Click to delete the selected schedule. |
|  | Click to resume the selected schedule. |
|  | Click to pause the selected schedule. |

| GUI Element (A–Z) | Description |
|---|---|
|  | Click to refresh the Report Schedule Manager page. |
|  | Click to reset the width of the columns to the default setting. |
|  | Click to select columns to be visible in the table. For details, see “Working with Tables” in <i>Reference Information</i> . |
| Generation Time | The time (in the indicated time zone) that the schedule is to be generated. |
| Recipients | The individuals configured in the Report Manager to receive the report or report item at scheduled intervals. For details on configuring Schedules, see “Create New Schedule Dialog Box” on page 613. |
| Recurrence | The recurrence pattern for the selected schedule. |
| Report Name | The name of the report for which the schedule is configured. |
| Report Type | The type of report for which the schedule is configured. |
| Status | The status of the schedule. Possible values are: <ul style="list-style-type: none"> <li data-bbox="625 958 725 984">➤ Active <li data-bbox="625 996 729 1022">➤ Paused |

19

Recipients Manager

This chapter provides information on Recipients Manager.

This chapter includes:

Concepts

- ▶ Recipients Manager Overview on page 507

Tasks

- ▶ Define an Email Recipient on page 507

Reference

- ▶ Recipients Manager User Interface on page 508

Recipients Manager Overview

The Recipients Manager enables you to define the recipients who can automatically receive scheduled reports, through email, at regular intervals, from Report Manager. For details, see “Report Manager” on page 597.

Define an Email Recipient

When you create a new email recipient, you click the **Add** button in the Recipients Manager window and enter the recipients name and email address. For details, see “Recipient Dialog Box” on page 508.

Recipients Manager User Interface

This section describes:

- ▶ Recipient Dialog Box on page 508
- ▶ Recipients Manager Window on page 509

Recipient Dialog Box

| | |
|------------------------------|---|
| Description | <p>Enables you to create a new email recipient or edit the properties of an existing one.</p> <p>To access:</p> <ul style="list-style-type: none"> ▶ To create a new email recipient, click the Add button in the Recipient Manager window. <p>Note: You can also access this dialog box through the Reports Manager. For details, see “Report Manager Main Page” on page 608.</p> <ul style="list-style-type: none"> ▶ To edit the properties of an existing recipient, select the required recipient in the Recipient Manager window and click the  button. |
| Important Information | Multiple emails can be defined using a semicolon (;) delimiter, or as separate entries. |
| Included in Tasks | “Define an Email Recipient” on page 507 |



The following elements are included (unlabeled GUI elements are shown in angle brackets>):

| GUI Element (A-Z) | Description |
|----------------------|---|
| Email Address | The email address of the email recipient. |
| Name | The name of the email recipient. |

Recipients Manager Window

| | |
|------------------------------|---|
| Description | Enables you to create new email recipients or edit the properties of existing email recipients. To access: Click Admin > Settings > Recipients Manager . |
| Included in Tasks | “Define an Email Recipient” on page 507 |
| Important Information | Only the recipients whose email addresses are defined here, can automatically receive scheduled reports through email from Report Manager. |
| Useful links | “Report Manager” on page 597 |

The following elements are included (unlabeled GUI elements are shown in angle brackets>):

| GUI Element (A-Z) | Description |
|---|--|
|  | Click the button beside the recipient whose properties you want to modify. The Recipient dialog box opens. |
|  | Delete the selected recipient. |
| Add | Click the Add button to define a new email recipient. |
| Email Address | The email address of the email recipient. |
| Name | The name of the email recipient. |

20

Federated CMDB

Information on federated CMDB has moved to the new Integrations book.

For details, see “Federated CMDB Window” in *Integrations*.

Part III

Application

21

Topology View Application

This chapter provides information on the Topology View application.

This chapter includes:

Concepts

- ▶ Topology View Overview on page 516

Tasks

- ▶ Retrieve Correlation Results – Scenario on page 516
- ▶ Take a Snapshot of a View on page 525
- ▶ Print and Save a Topology Map to File on page 526

Reference

- ▶ Topology View Application User Interface on page 526

Topology View Overview

Topology View displays the CIs of the currently selected view in graphical format. Topology View includes the same functionality as IT Universe Manager, however their context menu options differ. For information on the Topology Map, see “Working with Topology Map” on page 689.

The following tasks represent the basic functionality of the Topology View application:

- ▶ **Get Correlation results.** Topology View enables you to run the Correlation rules you defined for that view to simulate how certain defined changes impact your system, and to discover the root causes of the changes. For more information about Correlation rules, see “Correlation Manager Overview” on page 177. You can run the Correlation rule you defined in the Correlation Manager. For details, see “Retrieve Correlation Results – Scenario” on page 516.
- ▶ **Take a snapshot of a view.** HP Universal CMDB enables you to display the status of a view in one snapshot by comparison with its status taken at a different time. For details on how to take snapshots, see “Take a Snapshot of a View” on page 525.

Retrieve Correlation Results – Scenario

Correlation Manager enables you to create a Correlation rule that allows you to simulate the impact certain infrastructure changes have on your system. The results of the Correlation rule are displayed in the Topology View application. The Correlation results in this task describes how a change in CPU usage affects the Host node to which it is connected.

Note: To retrieve the required Correlation results, you must follow the steps in this task.

This task includes the following steps:

- “Create an Enumeration Definition” on page 517
- “Define a State” on page 518
- “Define a Correlation TQL Query” on page 519
- “Define a Correlation Rule” on page 520
- “Create a TQL of the Type View in Query Manager” on page 522
- “Create a View in View Manager” on page 522
- “Get Correlation Results” on page 522

1 Create an Enumeration Definition

To retrieve Correlation results, you must create a Correlation rule in the Correlation Manager. A Correlation rule is based on a state that exists in the State Manager. For details, see “State Manager” on page 499.

Note: This step is optional. You can use the default Enumeration definitions that appear in the System Type Manager.

A state is based on an Enumeration definition. Enumerations are designed to be used as severity value lists by states. You can either base a state on an existing Enumeration definition in the State Manager or, if required, create one by clicking the **New Enumeration** button. For details on creating Enumeration definitions, see “Create/Update List/Enumeration Definition Dialog Box” on page 240.

Note: Alternatively, you can create an Enumeration definition in the System Type Manager. For details, see “System Type Manager” on page 208. The Enumeration definition you create appears in the State Manager.

Example of an Enumeration Definition

Select **Admin > Settings > State Manager** to open the State Manager. In the bottom-right corner, click the **New Enumeration** button to open the Create Enumeration Definition dialog box.

The following Enumeration definition creates a severity list that represents CPU usage of 10%, 20%, and 50%.

Name:

Display Name:

List Enumeration

Enumeration Definition

10% load

20% load

50% load

Value:

Key:

Color

Green

Light Olive

Yellow

Orange

Red

Gray

2 Define a State

When you create a Correlation Rule, you select the state on which the Correlation condition is based. The State Manager contains two default states — Change and Operation. Each one is based on its own severity list. You can use a default state, or if required, create one based on a severity list (Enumeration definition) that is more relevant to your needs.

Note: This step is optional. You can use the default State that appear in the State Manager.

To define a new state, select **Admin > Settings > State Manager** to open the State Manager. For details on defining a new state, see “State Manager Dialog Box” on page 501.

Example of a New State Definition

A new state called **cpu_usage** is defined in the State Manager. Its Type Definition is based on the Enumeration definition called **cpu_usage** defined in the previous task.

| Name | Description | Type Definition |
|-----------|-----------------|---|
| change | Change State | Change States |
| operation | Operation State | Operation States |
| cpu_usage | CPU usage | <div style="border: 1px solid gray; padding: 2px;"> <ul style="list-style-type: none"> Admin States Test States Operation States concrete_synch_config_status synch_unit_state Status Accounting Identification Type cpu_usage </div> |

3 Define a Correlation TQL Query

To define a Correlation TQL query, you need to create a Correlation rule and then add then add the TQL nodes and relationships that define the query.

To create a Correlation TQL query, select **Admin > Modeling > Correlation Manager**. For details about how to add nodes and relationships to a query, see “Add Nodes and Relationships to a TQL Query” on page 330.

Example of a Correlation TQL Query

In this Correlation TQL query, a CPU and a Host node are linked by a Container Link relationship.

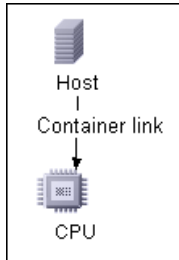

4 Define a Correlation Rule

When you define a Correlation rule, you must specify the required causal relationship between the nodes. Define one node as the trigger, or the node that represents the changes you want to make to the system, and another node as the one that is affected.

Right-click the node you want to define as the trigger node and select **Define Affected** to open the Affected Nodes dialog box. In the Affected Nodes dialog box, select the node you want the trigger node to affect. Then click the **Add** button to open the Correlation Definition dialog box to set conditions for defining affected nodes. For details about how to define a Correlation rule, see “Correlation Definition Dialog Box” on page 187.

Example of a Correlation Rule

The Conditions area in the Correlation Definition dialog box defines the conditions under which the simulated change in the system is triggered. The Affected Severity area defines the severity of the Correlation impact on the affected node.

The Correlation rule in this example states that when the CPU usage of the Host node to which the CPU node is connected does not equal 10%, the Host node is automatically assigned the 50% load status, which in this case, is the color red according to the severity list.

Description: CPU usage

Conditions

State:

Operator:

Value comparison:

Scope

Any

All

Range % - %

Affected Severity

Fixed severity:

Severity relative to trigger severity (%):

In the resulting TQL query, an upward arrow appears next to the node defined as the trigger node and a downward arrow appears next to the node defined as the affected node.

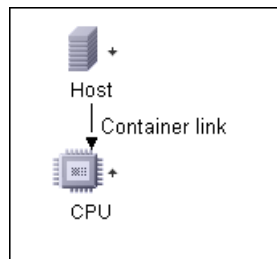

5 Create a TQL of the Type View in Query Manager

The Correlation TQL query created in the Correlation Manager appears in Query Manager as the type Correlation.

In Query Manager (select **Admin > Modeling > Query Manager**), right-click the query in the TQLs pane and save it as the type View. For details, see “Query Manager Window” on page 288.

6 Create a View in View Manager

Create a view in View Manager (select **Admin > Modeling > View Manager**) based on the TQL query of the type View you created in Query Manager in the previous task. For details, see “New View/View Properties/Save As View Wizard” on page 154.

7 Get Correlation Results

Select **Application > Topology View** and select the required view in View Explorer. To get Correlation results, you need to run the Correlation rule on a CI instance in the topology map that is a trigger. Right-click a trigger CI and select **Run Correlation** to open the Run Correlation dialog box. For details on how to run a Correlation rule, see “Run Correlation Dialog Box” on page 528.

Important: In the **State** box, you must select the state you used to define the Correlation rule in the Correlation Definition dialog box. In the **Triggers Severity** box, you must choose a severity that is other than what you selected in the **Value Comparison** box in the Correlation Definition dialog box. For details, see “Correlation Definition Dialog Box” on page 187.

Example for Getting Correlation Results

A TQL Correlation query is created containing a CPU and Host node connected by a Container Link relationship. The CPU node is defined as the trigger node and the Host node is defined as the affected node.

The following Correlation rule is defined for the query.

The screenshot shows a configuration dialog box for a correlation rule. It is titled "Description: CPU usage". The "Conditions" section has three dropdown menus: "State" set to "cpu_usage", "Operator" set to "Not equal", and "Value comparison" set to "10% load". The "Scope" section has three radio buttons: "Any" (selected), "All", and "Range" (with input fields for "0" and "100" and a minus sign between them). The "Affected Severity" section has two radio buttons: "Fixed severity:" (selected) with a dropdown menu set to "50% load", and "Severity relative to trigger severity (%):" with an input field set to "100".

In Topology View, select the required view, right-click a CPU CI, and select **Run Correlation** to open the Run Correlation dialog box. In the **State** box, select **cpu_usage**, as this was the state on which the Correlation rule was based. The trigger severity selected is other than the one assigned to the trigger node in the **Value Comparison** box.

The screenshot shows a smaller dialog box with two dropdown menus. The "State:" dropdown is set to "cpu_usage" and is highlighted in blue. The "Triggers Severity:" dropdown is set to "20% load". At the bottom, there are four buttons: "Show in Views", "Show Map", "Generate Report", and "Cancel".

To see results, click one of the following:

- **Show in Views.** This assigns a status to all the CIs in the view. Only the Host CI connected to the CPU CI (whose severity was changed), becomes affected and turns red because CPU usage of the Host node no longer equals 10%. According to the Correlation rule, the Host node is automatically assigned the 50% load status, which in this case, is the color red according to the severity list. If the other CIs were not affected, so they remain green (10% load according to the Enumeration definition).

The trigger CPU CI turns light olive because 20% load was assigned the color light olive in the Enumeration definition.

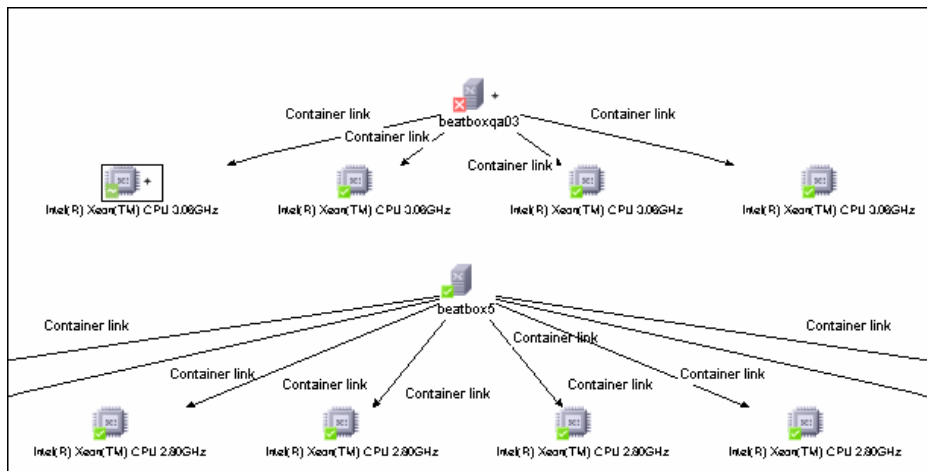

- **Show Map.** A map appears in a separate window containing only the trigger CPU CI and the Host CI it affected. The relationship connecting the two CIs contains the name of the Correlation rule defined in the Correlation Manager.

Note: Optionally, you can create a URL that enables you to embed the map. For details, see “Direct Link Parameters – Show Impact Map Page” on page 427.

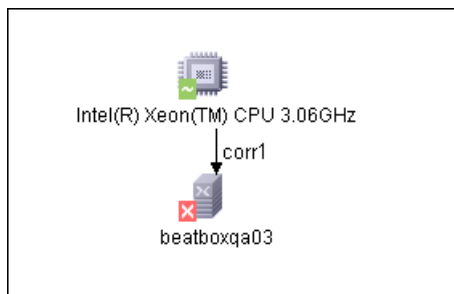

- **Generate Map.** Generates an Impact Analysis report that displays a list of CIs that are impacted in the system as a result of the simulated changes. For details, see “Run Correlation Dialog Box” on page 528.

Take a Snapshot of a View

You can take a snapshot of a view in Topology View application, save it, and then compare snapshots of the same view taken at different times using Compare Snapshots in **Application > Compliance > Compare Snapshots**. For details on how to take a snapshot of a view, see “Save Snapshot Dialog Box” on page 531. For details on how to view actual differences in the compared views, see “Compare Snapshots Window” on page 559.

Print and Save a Topology Map to File

You can print the content of any topology map and then save it to file. Before printing, it is recommended to define your print settings and arrange the contents of the topology map according to your requirements.

For details on how to define print settings, see “Print Setup Dialog Box” on page 715.

For details on how to preview the content of the topology map before printing, see “Print Preview Dialog Box” on page 715.

For details on how to print the content of a topology map, see “Print Dialog Box” on page 714.

For details on how to save a topology map to file, see “Run Correlation Dialog Box” on page 528.

Topology View Application User Interface

This section describes:

- ▶ Correlation Rules Window on page 527
- ▶ Run Correlation Dialog Box on page 528
- ▶ Save Snapshot Dialog Box on page 531
- ▶ Topology View Window on page 532

Correlation Rules Window

| | |
|------------------------------|--|
| Description | <p>Opens a window that displays the statuses of the trigger CI as well as all statuses of the CIs that are affected by it. The relationships in the map represent the Correlation rules. The name of the relationship is the name of the Correlation rule you defined in the Correlation Manager.</p> <div data-bbox="615 413 762 621" style="border: 1px solid black; padding: 5px; text-align: center;">  </div> <p>To access: In the Run Correlation Dialog box, click Show Map.</p> |
| Important Information | <ul style="list-style-type: none"> ▶ You can only see Correlation results if you defined a Correlation rule for that view in Correlation Manager. For details, see “Correlation Manager” on page 177. ▶ To view information about specific CIs that are triggered or affected by the Correlation rule, double-click the relationship connecting the CIs. A map is displayed. |
| Included in Tasks | “Retrieve Correlation Results – Scenario” on page 516 |

The Correlation Rules window includes the following elements (listed alphabetically):



| GUI Element (A-Z) | Description |
|---|---|
| <Relationship> | The relationships represent the Correlation rule you defined in the Correlation Manager. For details, see “Correlation Definition Dialog Box” on page 187. |
| <The statuses and the colors that represent each one> | The statuses that appear and the colors that represent each status are the ones that are defined in the severity list for that state in the System Type Manager. For details, see “Create/Update List/Enumeration Definition Dialog Box” on page 240. |



Run Correlation Dialog Box

| | |
|-------------------------------------|--|
| <p>Description</p> | <p>Enables you to run the Correlation rule you defined in Correlation Manager for that view.</p> <p>You can:</p> <ul style="list-style-type: none"> ▶ Display in a new window all the CIs that are affected by the trigger CI. The relationships in the map represent the Correlation rules. The name of the relationship is the name of the Correlation rule you defined in the Correlation Manager. For details, see “Show Map” on page 530. ▶ Simulate how the statuses of the affected CIs are impacted. For details, see “Show in Views” on page 529. ▶ Generate a report that displays a list of CIs that are impacted in the system as a result of the simulated changes. For details, see “Generate Report” on page 529. <p>To access: Select Application > Topology View. Right-click a trigger node in the Topology Map and select Run Correlation.</p> |
| <p>Important Information</p> | <p>This dialog only appears if a Correlation rule is defined for that view. For details, see “Correlation Manager” on page 177.</p> |
| <p>Included in Tasks</p> | <p>“Retrieve Correlation Results – Scenario” on page 516</p> |

The Run Correlation dialog box includes the following elements (listed alphabetically):

| GUI Element (A-Z) | Description |
|------------------------|--|
| Generate Report | <p>Generates an Impact Analysis report, which displays information that is divided as follows:</p> <ul style="list-style-type: none"> ▶ Impacted CIs by CIT. All the impacted CIs (the CIs that are impacted in the system as a result of the simulated changes), sorted by CIT. ▶ Impacted CIs by Application. All the impacted CIs that belong to a specific business service. For details, see “Link Nodes to Application CI” on page 134. ▶ Trigger CIs. The CIs that represent the changes you want to make to the system. <p>Notes:</p> <ul style="list-style-type: none"> ▶ For information about limitations on the size of reports produced in .pdf format, see “Troubleshooting and Limitations” in <i>Reference Information</i>. (If the default values do not suit your needs, and must be modified, contact Customer Support.) ▶ For details on how to work with reports, see “Working in Reports - Overview” in <i>Reference Information</i>. |
| Show in Views | <p>Simulates how the statuses of the affected CIs are impacted for the selected state. The Topology Map displays the statuses of the trigger CIs as well as all statuses of the CIs that are affected by it.</p> <p>The Topology Map also displays the Correlation indicators:</p> <ul style="list-style-type: none"> ▶ A trigger CI is marked by this  indicator. ▶ A CI that is both an affected and a trigger CI is marked by this  indicator. ▶ An affected CI is marked by this  indicator. <p>Note: The statuses that appear here and the colors that represent each status are defined in the severity list for that state in the System Type Manager. For details, see “Create/Update List/Enumeration Definition Dialog Box” on page 240.</p> |

| GUI Element (A-Z) | Description |
|---------------------------|--|
| Show Map | <p>Enables you to select a Correlation rule, and then display in a new window, a simulation of all the CIs that are affected by the trigger CI for the selected state. If only one Correlation rule is defined for this CI, the Correlation Rules window is displayed directly. For more details, see “Correlation Rules Window” on page 527.</p> <p>The relationships in the map represent the Correlation rules and the name of the relationship is the name of the Correlation rule you defined in the Correlation Manager.</p> <p>Note: Show Map enables you to view the results of multiple triggers.</p> |
| State | <p>Select the required State. For details about States, see “State Manager” on page 499.</p> |
| Trigger’s Severity | <p>Select the required severity.</p> <p>Note: The severity list was defined for the state in the System Type Manager. For details, see “System Type Manager” on page 208.</p> <p>For example, you can create a Correlation rule in the Correlation Manager (see the “Correlation Definition Dialog Box” on page 187), that defines the severity of the trigger node as other than No Change. If you select a severity other than No Change, for example, Plan, the condition is met and the simulated changes in the system are triggered.</p> |

Save Snapshot Dialog Box

| | |
|------------------------------|--|
| Description | Enables you to take a snapshot of a view and save it. To access: Go to Application > Topology View and click the Save Snapshot button  in View Explorer. |
| Important Information | You can compare snapshots of the same view taken at different times using Compare Snapshots in Application > Compliance > Compare Snapshots . For details, see “Compare Snapshots Window” on page 559. |
| Included in Tasks | “Take a Snapshot of a View” on page 525 |

The Save Snapshot dialog box includes the following elements (listed alphabetically):

| GUI Element (A-Z) | Description |
|--------------------|---|
| Description | A description of the snapshot (optional). |
| Note | A note about the snapshot (optional). |
| View Name | The name of the view as it appears in View Explorer. This field cannot be edited. |

Topology View Window

| | |
|------------------------------|---|
| Description | <p>Displays the CIs of the currently selected view in graphical format and enables you to run the Correlation rule you defined in the Correlation Manager.</p> <p>To access: Select Application > Topology View.</p> |
| Important Information | <p>The Topology View window contains the following panes:</p> <ul style="list-style-type: none"> ▶ View Explorer (CI Selector). Displays the CIs of a selected view. You can select the view from a drop-down list. For details, see “View Explorer” on page 676. ▶ Topology Map. Displays the CIs of a selected view in Map mode or text mode. For details, see “IT Universe Manager Window” on page 66. ▶ Advanced Pane. Displays properties and history for the selected CI. For details, see “Advanced Pane” on page 73. <p>Note: The Topology View window shares the same functionality as the IT Universe Manager topology map. The Topology View application includes some additional context menu options and toolbar options. For details on the IT Universe Manager topology map, see “Topology Map” on page 67.</p> |
| Included in Tasks | <p>“Retrieve Correlation Results – Scenario” on page 516</p> <p>“Take a Snapshot of a View” on page 525</p> |
| Useful Links | <p>“Save Snapshot Dialog Box” on page 531</p> <p>“Set View Parameters/Set View Element Parameters Dialog Box” on page 163</p> |

Context Menu

The Topology View window includes the following elements (listed alphabetically) available by right-clicking a CI in the View Explorer pane or the Topology Map:

| GUI Element (A-Z) | Description |
|--|--|
| <IT Universe Manager context menu options> | The context menu options from IT Universe Manager are also available in the Topology View application. For details, see “IT Universe Manager Window” on page 66. |
| Run Correlation | <p>Enables you to run the Correlation rule you defined in the Correlation Manager. Displays the Run Correlation dialog box. For details, see “Correlation Manager” on page 177.</p> <p>Note: You can only see Correlation results if you defined a Correlation rule for that view in Correlation Manager.</p> |
| Show Impact | <p>Enables you to select a CI, which is defined by a Correlation rule as a root cause CI, and to display all the CIs that are affected by it, and their statuses, in a separate window.</p> <p>This option appears only after the following has occurred:</p> <ul style="list-style-type: none"> ▶ You defined a Correlation rule for the selected view in the Correlation Manager (for details, see “Correlation Manager” on page 177). ▶ You clicked Show in Views in the Run Correlation dialog box. ▶ Correlation results appear in the Topology Map. <p>For example, suppose a Correlation rule is defined for an IP CI, which specifies that the rule affects hosts, ports, and client-servers that are linked to the IP.</p> <p>By using the Show Impact option, you can display all CIs that are affected by the IP CI.</p> |

| GUI Element (A-Z) | Description |
|-------------------------------|---|
| <p>Show Root Cause</p> | <p>This option enables you to retrieve root cause information for CIs that are affected by a chain of Correlation rules. The output of Show Root Cause displays a logical map that describes a chain of trigger/affected CITs that affect the CI.</p> <p>The root cause CI is displayed in a separate window. If only one Correlation rule is defined for this CI, the Correlation window is directly displayed.</p> <p>This option appears only after the following has occurred:</p> <ul style="list-style-type: none"> ▶ You defined a Correlation rule for the selected view in the Correlation Manager (for details see, “Correlation Manager” on page 177). ▶ You clicked Show in Views in the Run Correlation dialog box. ▶ Correlation results appear in the Topology Map. <p>A window, as illustrated below, is displayed containing the root cause CI and all the other CITs in the Correlation rule chain.</p> <div data-bbox="576 913 725 1124" data-label="Diagram"> <p>The diagram shows a flow from a CI labeled 'agents' (with a warning icon) to a CI labeled 'A' (with a red 'X' icon). An arrow labeled 'Cor1' points from 'agents' to 'A'.</p> </div> <p>Use the Show Root Cause option on the A CI to view, in one step, that the source of the failure is the agents CI. The CI that the arrow points to is the affected CI.</p> <p>To view the information about specific CIs that are triggered or affected by the Correlation rule, double-click the relationship connecting the CIs. A map is displayed.</p> |

22

CI Lifecycle and the Aging Mechanism

This chapter provides information on the CI Lifecycle application that enables you to manage the aging mechanism.

This chapter includes:

Concepts

- ▶ The Aging Mechanism – Overview on page 536
- ▶ CI Lifecycle – Overview on page 537

Tasks

- ▶ Enable and Run the Aging Mechanism on page 538
- ▶ Generate CI Lifecycle Data and Filter the Results on page 540

Reference

- ▶ CI Lifecycle User Interface on page 541
- ▶ Aging Parameters on page 550

The Aging Mechanism – Overview

After your system has been running for some time, previously discovered CIs may no longer exist. Such CIs should be removed from UCMDB to keep it up to date.

Discovery and Dependency Mapping (DDM) runs periodically and updates the last access time for all CIs and relationships that it discovers. This process is known as "touching," and prevents CIs and relationships that represent active components in the system from becoming deletion candidates. If DDM does not discover a CI that exists in the CMDB, the last access time is not updated, so after some predefined time (by default, 20 days) the CI becomes a deletion candidate.

Deletion candidates are reviewed and managed in the CI Lifecycle module.

If the CI remains untouched for a longer period of time (by default, 40 days), the aging mechanism deletes the CI from the system. In other words, aging deletes CIs and relationships that are no longer relevant, that is, have not been accessed for a specified period of time (by default, 40 days).

The deletion of large quantities of CIs and relationships creates a significant load for the UCMDB and database servers and can impact overall UCMDB performance. To reduce this performance impact, the aging mechanism divides the objects to be deleted into chunks. A delay between chunks lowers the database load and enables other tasks to continue working. For faster work, you can shorten the delay, but the default delay value is the recommended delay. For details, see "Aging Parameters" on page 550.

Note:

- ▶ The aging mechanism is disabled by default.
 - ▶ Aging operations are run only on CIs and relationships that have **Enable Aging** set to **true**. By default, CIs and relationships added by out-of-the-box DDM patterns are created with **Enable Aging** set to **true**. (For details, see Enable Aging in the “Configuration Item Properties Dialog Box” on page 53.) This behavior can be changed in the **Enable aging** check box in DDM in the Pattern Management tab. For details, see Enable aging in *Discovery and Dependency Mapping Guide*.
-

CI Lifecycle – Overview

The CI Lifecycle application enables you to view a list of CIs and relationships that are candidates for deletion by the aging mechanism, and to initiate the aging procedure. You can also select specific CIs or relationships and postpone their deletion or mark them as deletion-proof.

For each CIT, you can set the time period before a specific CI becomes a candidate for deletion or before it is actually deleted. For details, see Actual Deletion Period, Deletion Candidate Period, and Enable Aging in the “Configuration Item Properties Dialog Box” on page 53.

Enable and Run the Aging Mechanism

This task describes how to enable aging and run the aging mechanism.

This task includes the following steps:

- ▶ “Enable Aging” on page 538
- ▶ “First Aging Run” on page 538

1 Enable Aging

Access the Aging Status tab in the CI Lifecycle window (**Application > CI Lifecycle**). Select the **Enable Aging** check box. For details, see “Aging Status Tab” on page 542.

Note: When aging is turned on or off (that is, enabled or disabled), you must restart the server for the changed setting to take effect.

2 First Aging Run

After your system has been running for some time, there are probably many CIs that need deleting. You should perform this step in the procedure to keep UCMDB and the database up to date.

If the number of CIs to be deleted is greater than 10,000, a confirmation message is displayed. Choose between the following options:

- ▶ UCMDB divides the number of CIs and/or relationships that must be deleted into chunks (to avoid overloading the database), deletes them, and adds the information to the History database. Chunk size is determined by the value in the **Aging Chunk Size** field in the Infrastructure Settings Manager.

This is the preferred method of deletion because the History database is updated with the information and there is no server downtime.

- ▶ You run the database aging tool, located at <UCMDB installation folder>\UCMDBServer\j2f\cmdb\dbscripts\dbtool.bat. If you choose this option, you must stop the UCMDB server service.

You would choose this second option if you needed a fast system of deletion: the database aging tool is an order of magnitude faster than the aging mechanism.

Important: Before running this option, be aware of the following:

- ▶ You must completely shut down the server before running the tool, that is, there will be server downtime.
- ▶ No information is written to the History database.

To run the database aging tool:

- a** Back up the UCMDB database schemas. This step is mandatory.
- b** Run the tool in a testing environment before running it in a production environment. This step is recommended.
- c** Stop the UCMDB server.
- d** Run the **dbtool.bat** file from the file system.
- e** Restart the UCMDB server.
- f** Return to the Aging Status tab and enable aging.

Note: You may need to run the index maintenance tool after running the aging tool. For details on running the index tool, see “Index Maintenance Utility” in the *HP Universal CMDB Database Guide* PDF.

Generate CI Lifecycle Data and Filter the Results

This task describes how to generate a list of CIs that are candidates for deletion, and to filter the results.

This task includes the following steps:

- ▶ “Generate CI Lifecycle Data” on page 540
- ▶ “Filter the CI Lifecycle Results” on page 540

1 Generate CI Lifecycle Data

To generate CI Lifecycle results for CIs or relationships, select either the **CIs** tab or the **Relationship** tab. Select the time period in which to search, using the drop-down calendars in the **From** and **To** fields, and click **Generate**. For details, see “CI Lifecycle Window” on page 548.

UCMDB displays a list of CITs that are candidates for deletion.

Tip: If no results are generated, try extending the time period further into the future.

2 Filter the CI Lifecycle Results



To filter the CI Lifecycle data, click the **Filter** button to open the Filter dialog box. For each column by which you want to filter, select a condition from the drop-down list and fill in the value column, either by entering a value, selecting from a drop-down list, or using the calendar. Click **OK** to apply your filter.



To clear the filter and restore the original results, click the **Clear** button. For details, see “Filter Dialog Box” on page 549.

CI Lifecycle User Interface

This section describes:

- Aging Run Statistics Dialog Box on page 541
- Aging Status Tab on page 542
- CI Lifecycle Report on page 543
- CI Lifecycle and Relationship Tabs on page 545
- CI Lifecycle Window on page 548
- Filter Dialog Box on page 549

Aging Run Statistics Dialog Box

| | |
|--------------------------|---|
| Description | Enables you to view statistics for the five previous runs of the aging mechanism. To access: Click the Statistics button  in the CI Lifecycle window. |
| Included in Tasks | “Enable and Run the Aging Mechanism” on page 538 |

The following elements are included (unlabeled GUI elements are shown in angle brackets>):

| GUI Element (A-Z) | Description |
|-------------------|---|
| Aging Runs | Run at. The start and finish time of the run. Deleted. The number of CIs that have been deleted. Failed. The number of CIs that have not been deleted. |
| Errors | ID. The IDs of the failed CIs, that is , of the CIs that could not be deleted. Error message. A message describing the cause of failure. |

Aging Status Tab

| | |
|------------------------------|---|
| Description | <p>Enables you to enable the aging mechanism and to run the mechanism for the first time.</p> <p>To access: Select Application > CI Lifecycle.</p> |
| Important Information | <p>This tab displays information about the number of CIs that are candidates for deletion, and functions as follows, if you select the Enable Aging check box:</p> <ul style="list-style-type: none"> ▶ If the number of CIs for deletion is larger than 10,000, you can choose to use the aging mechanism to delete the CIs in chunks, or to use the database aging tool. For details on which procedure to use, see “First Aging Run” on page 538. ▶ If the number of CIs for deletion is smaller than 10,000, the estimated time for deletion is displayed and the CIs are immediately deleted. A progress bar shows the stage of the deletion. |
| Included in Tasks | <p>“Enable and Run the Aging Mechanism” on page 538</p> |



The following elements are included (unlabeled GUI elements are shown in angle brackets>):

| GUI Element (A-Z) | Description |
|-------------------|--|
| Enable Aging | <ul style="list-style-type: none"> ▶ To enable aging, select the check box. The frequency and size of the chunks that are marked as candidates for deletion are determined in the Infrastructure Settings Manager. For details, see “Aging Parameters” on page 550. ▶ To disable aging, clear the check box. |
| Run results | <p>Total CIs to delete. The number of CIs or relationships that are delete candidates and that are being deleted by the aging mechanism.</p> <p>Deleted. The number of CIs or relationships that have been deleted.</p> <p>Failed. CIs or relationships that could not be deleted. If any failures exist, click the Failed link to view their details.</p> |

CI Lifecycle Report

| | |
|------------------------------|---|
| Description | <p>Enables you to present filtered CI Lifecycle results in report format and to print or export them, or to send them by email.</p> <p>To access: Click Report Export from the CI Lifecycle window.</p> |
| Important Information | <p>The CI Lifecycle report is generated for the period selected in the CI Lifecycle window. From the CI Lifecycle report dialog box, you can adjust the period and regenerate the results within the dialog box.</p> |
| Useful Links | <p>For details on working with reports, see “Working in Reports” in <i>Reference Information</i></p> <p>For details on the View pane, see “Common Report Elements” in <i>Reference Information</i></p> |









The following elements are included (unlabeled GUI elements are shown in angle brackets>):





| GUI Element (A-Z) | Description |
|---|--|
|  | Click to reset the width of the columns to the default setting. |
|  | Click to open the Select Columns dialog box, which enables you to change the display order of the columns, hide a column, or display a hidden column. For details, see “Working with Tables” in <i>Reference Information</i> . |
| Actual Delete Time | The date and time when the CI or relationship is deleted. |
| Configuration Item Type | The type of CI or relationship. |
| End1 | The node at one end of the relationship (relevant only for relationships). |
| End2 | The node at the second end of the relationship (relevant only for relationships). |
| From | Indicates the beginning of the period for the generation of the report. Click on the link to open a calendar which enables you to change the date and time. |
| Generate | Click Generate to generate the data for the selected period. |
| Label | The name of the CI or relationship as it appears in the Topology Map. |
| Last Access Time | The last time the CI or relationship was accessed, whether it was updated or discovered by DDM. |
| To | Indicates the end of the period for the generation of the report. Click the link to open a calendar that enables you to change the date and time. |
| Updated By | The administrator or process that updated the CI or relationship. |
| View | Sets the time period of the report from the beginning time. Select a time period from the drop-down list. |

CI Lifecycle and Relationship Tabs

| | |
|--------------------------|---|
| Description | Enable you to display a list of CIs and relationships that are candidates for deletion, and to manage the list (for example, to delete or prevent or postpone deletion of specific CIs, to view statistics, and to filter the list). To access: Select Application > CI Lifecycle . |
| Included in Tasks | “Generate CI Lifecycle Data and Filter the Results” on page 540 |
| Useful Links | “Working with CIs” on page 37 |

The following elements are included (unlabeled GUI elements are shown in angle brackets>):

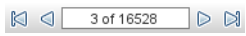
| GUI Element (A-Z) | Description |
|---|---|
|  | Click to delay the deletion of a CI. It disappears from the list of candidates for deletion. |
|  | Click to prevent a CI or relationship from being deleted. It disappears from the list of candidates for deletion. |
|  | Click to delete a selected CI or relationship. |
|  | Click to view statistics (such as the start and finish time of each run and the number of deleted CIs), for the previous five runs of the aging mechanism. For details, see “Aging Status Tab” on page 542. |
|  | Click to select or clear all rows of data on the current page. |
|  | Click to update the data displayed. |
|  | Click to open the Filter dialog box, which enables you to customize the filter. For details, see “Filter Dialog Box” on page 549. |
|  | Click to clear the filter and display the full results. |

| GUI Element (A-Z) | Description |
|---|--|
|  | <p>Click to open the Select Columns dialog box, which enables you to change the display order of the columns, hide a column, or display a hidden column. For details, see “Select Columns Dialog Box” in <i>Reference Information</i>.</p> |
|  | <p>Click the arrow to define the number of rows that should appear on each display page.</p> |
|  | <p>Click to navigate through the results page by page or to jump to the first or last page.</p> |
|  | <p>Generates data for a selected period. Tip: If no results are generated, try extending the time period further into the future (the To field).</p> |
|  | <p>Opens the CI Lifecycle Report dialog box, which presents the data in the format of a report. For details, see “CI Lifecycle Report” on page 543.</p> |
| <p><Right-click a CI></p> | <p>For details on the menu options, see “IT Universe Manager Context Menu” on page 71.</p> |
| <p><Right-click a column header></p> | <p>For details, see “Customizing Columns” in <i>Reference Information</i>.</p> |

| GUI Element (A-Z) | Description |
|-------------------------------|---|
| CIs/Relationships tabs | <p>Select to see a list of CIs or relationships that are candidates for deletion:</p> <p>Select. Select the check box to select a CI or relationship before performing an operation on it (such as Delete or Postpone Deletion).</p> <p>End1. The node at one end of the relationship (relevant only for relationships).</p> <p>Display Label. The name of the CI or relationship as it appears in the Topology Map.</p> <p>End2. The node at the second end of the relationship (relevant only for relationships).</p> <p>CI Type. The type of the CI or relationship.</p> <p>Last Access Time. The last time that the CI or relationship was accessed, whether it was updated or discovered by the DDM process.</p> <p>Updated by. The administrator or process that updated the CI or relationship.</p> <p>Actual Delete Time. The date and time when the CI or relationship is deleted.</p> |
| From | Click the arrow and use the calendar to select the beginning date and time for the CI Lifecycle report. |
| Relationships tab | Select to see lifecycle results for relationships. |
| Set Rows per Page | Select the number of rows per page from the drop-down list. |
| To | Click the arrow and use the calendar to select the end date and time for the CI Lifecycle report. |

CI Lifecycle Window

| | |
|------------------------------|---|
| Description | <p>Enables you to enable and run the aging mechanism. Also, enables you to display a list of CIs and relationships that are candidates for deletion, and to manage the list (for example, to delete or prevent or postpone deletion of specific CIs, to view statistics, and to filter the list).</p> <p>To access: Select Application > CI Lifecycle.</p> |
| Important Information | <p>The CI Lifecycle window includes the following tabs:</p> <ul style="list-style-type: none"> ▶ Aging Status. Use this tab to enable the aging mechanism and to run aging. For details, see “Aging Status Tab” on page 542. ▶ CIs. Use this tab to display a list of CIs that are candidates for deletion. For details, see “CI Lifecycle and Relationship Tabs” on page 545. ▶ Relationships. Displays the same information as the CIs tab, with the addition of the End1 and End2 columns. <p>The tab that is displayed by default depends on whether aging is enabled or disabled:</p> <ul style="list-style-type: none"> ▶ If aging is enabled, the CIs tab is displayed. ▶ If aging is disabled, the Aging Status tab is displayed. |
| Included in Tasks | <ul style="list-style-type: none"> ▶ “Enable and Run the Aging Mechanism” on page 538 ▶ “Generate CI Lifecycle Data and Filter the Results” on page 540 |
| Useful Links | <p>“Working with CIs” on page 37</p> |

Filter Dialog Box

| | |
|--------------------------|--|
| Description | Enables you to filter the list of CIs that are candidates for deletion. To access: Click Filter in the CI Lifecycle window. |
| Included in Tasks | “Generate CI Lifecycle Data and Filter the Results” on page 540 |

The following elements are included (unlabeled GUI elements are shown in angle brackets>):

| GUI Element (A-Z) | Description |
|---------------------|--|
| Condition | Click in the Condition column and select an option. |
| Display Name | The columns displayed for the CIs or relationships in the CI Lifecycle window. |
| Value | Click in the Value column to set a value for the selected condition. Depending on the condition selected, you can select a value from a drop-down list, select a date and time from the calendar, or click the ellipsis button  to open an editing dialog box where you can enter a value. When the conditions Like or Like ignore case are selected in the Condition column, you can use a wildcard (%) before and after the string you are searching for. Note: You must select a condition before entering a value. |

Aging Parameters

Aging parameters are defined in the Infrastructure Settings Manager (**Admin > Settings > Infrastructure Settings Manager**):

- ▶ **Aging Chunk Size.** The number of CIs or relationships that are sent to the aging mechanism at one time. The default is 1,000.
- ▶ **Aging Scheduler Hour of the First Run.** Defines at what time aging first runs after server startup (for example, 02=2:00 AM).
- ▶ **Aging Scheduler Interval.** Defines the interval between runs. If Aging Time Unit = days, the interval value is days; if Aging Time Unit = hours, the interval value is hours.
- ▶ **Aging Time Unit.** The default is days. (The hours option is provided to enable convenient verification checks of specific CIs.)
- ▶ **Delay Between Chunks in Milliseconds.** The period between one chunk being deleted by the aging mechanism and the next chunk being sent to the aging mechanism to be deleted. The default is 30 seconds, that is, 30,000 milliseconds.
- ▶ **Threshold for running storage optimization.** The threshold for running storage optimization during the aging operations (for example, each N deleted CIs). As database operations could take considerable time (several minutes), this option enables the technical organization of the schema to reduce this time.

23

Gold Master Report

This chapter provides information on Gold Master reports.

This chapter includes:

Concepts

- ▶ Gold Master Report Overview on page 551

Reference

- ▶ Gold Master Report User Interface on page 551

Gold Master Report Overview

A Gold Master report compares the configuration of a Gold Master CI to other CIs of the same CI type, or a descendant of the CI type. The report contains the results of the Gold Master report definition defined in Topology Report Manager. For details, see “Gold Master Report Pane” on page 261.

Gold Master Report User Interface

This section describes:

- ▶ Gold Master Report Page on page 552

Gold Master Report Page

| | |
|------------------------------|---|
| Description | Specifies which of the selected CIs are configured differently from the Gold Master CI. To access: Select Applications > Compliance > Gold Master . |
| Important Information | <ul style="list-style-type: none"> ➤ Verify that popups are not blocked in your browser. ➤ For details on how to work with reports, see “Working in Reports” in <i>Reference Information</i>. |

Left Pane

| | |
|--------------------|---|
| Description | Select the required Gold Master report definition you want to generate. |
|--------------------|---|

The following elements are included (unlabeled GUI elements are shown in angle brackets>):

| GUI Element (A-Z) | Description |
|------------------------|---|
| Definitions tab | Displays a hierarchical tree structure of the Gold Master reports defined in Topology Report Manager. For details, see “Gold Master Report Pane” on page 261. |

| GUI Element (A-Z) | Description | | | | | | | | | | | | | | | | | | | | | |
|--------------------|---|--------|------|------|-------|--|--|-------|---------|-------|-------|---------|-------|-------|---------|-------|-------|---------|-------|-------|---------|-------|
| Results tab | <p>The Gold Master report you select in the Definitions pane is automatically selected in the Results pane.</p> <p>If you have defined a task in the Scheduler that generates and saves a Gold Master report on a periodic basis, you can produce a Gold Master report that was generated at a specific time or a by a specific user. For details on how to schedule a task, see “Scheduler” on page 485.</p> <table border="1" data-bbox="621 482 888 737"> <thead> <tr> <th>Report</th> <th>Date</th> <th>User</th> </tr> </thead> <tbody> <tr> <td>gold1</td> <td></td> <td></td> </tr> <tr> <td>gold1</td> <td>Sun Jul</td> <td>admin</td> </tr> <tr> <td>gold1</td> <td>Sun Jul</td> <td>admin</td> </tr> <tr> <td>gold1</td> <td>Sun Jul</td> <td>admin</td> </tr> <tr> <td>gold1</td> <td>Sun Jul</td> <td>admin</td> </tr> <tr> <td>gold1</td> <td>Mon Jul</td> <td>admin</td> </tr> </tbody> </table> <p>From the:</p> <ul style="list-style-type: none"> ➤ Report list, select the required Gold Master report. ➤ Date list, select the required time. ➤ User list, select the required user. <p>Note: For details on how to customize columns and divide a table of data or a list of reports into pages, see “Working in Reports” in <i>Reference Information</i>.</p> | Report | Date | User | gold1 | | | gold1 | Sun Jul | admin | gold1 | Sun Jul | admin | gold1 | Sun Jul | admin | gold1 | Sun Jul | admin | gold1 | Mon Jul | admin |
| Report | Date | User | | | | | | | | | | | | | | | | | | | | |
| gold1 | | | | | | | | | | | | | | | | | | | | | | |
| gold1 | Sun Jul | admin | | | | | | | | | | | | | | | | | | | | |
| gold1 | Sun Jul | admin | | | | | | | | | | | | | | | | | | | | |
| gold1 | Sun Jul | admin | | | | | | | | | | | | | | | | | | | | |
| gold1 | Sun Jul | admin | | | | | | | | | | | | | | | | | | | | |
| gold1 | Mon Jul | admin | | | | | | | | | | | | | | | | | | | | |

Right Pane

| | |
|-------------------------------------|---|
| <p>Description</p> | <p>Compares the attribute values of the CIs in the Gold Master CI subgraph to the attribute values of the CIs in the subgraph of the Compared CI in the CMDB.</p> <p>Note: Only attributes that have been assigned the Comparable qualifier in the CIT Manager (for details, see “CI Type Manager” on page 205), can be compared.</p> <p>Each section of the report contains a table comparing the attribute values of the Gold Master CIs to the attribute values of the Compared CI of the same CIT.</p> <p>Note: The Gold Master report only displays a CI attribute comparison if the values are different.</p> <p>If a section is empty, it means that all attribute values of the Gold Master CIs and the Compared CIs for that CIT are identical. In such a case, the attributes in the next layer in the subgraph are compared, and the next one, and so on.</p> <p>Once the compared CIs in a layer are found to have different attributes, the Gold Master report does not continue to compare the layers in the subgraph for differences.</p> <p>For a sample of a Gold Master report, see “Sample Gold Master Report” on page 555.</p> |
| <p>Important Information</p> | <p>For details on how to work with reports, see “Working in Reports” in <i>Reference Information</i>.</p> |

The following elements are included (unlabeled GUI elements are shown in angle brackets>):

| GUI Element (A-Z) | Description |
|-------------------|---|
| # in Compared CI | The number of CIs for that element type (CIT) the Compared CI subgraph contains. |
| # in Gold Master | The number of CIs for that element type (CIT) the Gold Master CI subgraph contains. |
| Attributes | The CI attribute. |

| GUI Element (A-Z) | Description |
|-------------------------|---|
| Compared CI | The display name of the Compared CI. |
| Element Type | The CIT of the CI. |
| Label | The display label of the Gold Master CI. |
| Report Date | The time and date the report was generated. |
| Value in Compared CI | The value of the attribute in the Compared CI. |
| Value in Gold Master CI | The value of the attribute in the Gold Master CI. |

Sample Gold Master Report

Gold Master CI

Gold Master CI - labm1ccm14
Report Date - Sun May 4, 2008 10:13 AM

Compared CI - labm1mam13

Element Type - Windows, # in Gold Master - 1, # in Compared CI - 1

| Label | Attributes | Value in Gold Master CI | Value in Compared CI |
|--------------------------|---|---------------------------|---------------------------|
| labm1ccm14 Vs labm1mam13 | Host Operating System Installation type | Server Enterprise Edition | Server Enterprise Edition |
| labm1ccm14 Vs labm1mam13 | Host Operating System | Windows 2003 | Windows 2003 |
| labm1ccm14 Vs labm1mam13 | Host Vendor | Microsoft | Microsoft |
| labm1ccm14 Vs labm1mam13 | Host Operating System accuracy | none | none |
| labm1ccm14 Vs labm1mam13 | Host Model | ProLiant DL140 G2 | ProLiant BL460c G1 |
| labm1ccm14 Vs labm1mam13 | Host Operating System Release | 3790 | 3790 |
| labm1ccm14 Vs labm1mam13 | Host Operating System Version | 5.2.3790 | 5.2.3790 |

The sample Gold Master report shows the following:

- The Gold Master CI **labm1ccm14** is being compared to the Compared CI **labm1mam13**.
- **Windows** attribute values in the Gold Master subgraph are being compared with the **Windows** attribute values in the Compared CI subgraph.
- There is one **Windows** CI in the Gold Master subgraph and one **Windows** CI in the Compared CI subgraph.

24

Compare Snapshots

This chapter provides information on Compare Snapshots.

This chapter includes:

Concepts

- ▶ Compare Snapshots Overview on page 557

Tasks

- ▶ Snapshot Comparison on page 557

Reference

- ▶ Compare Snapshots User Interface on page 559

Compare Snapshots Overview

Compare Snapshots displays the status of a view in one snapshot by comparison with its status taken at a different time. You can compare a current snapshot to a previous snapshot or two snapshots both taken in the past. For details, see “Compare Snapshots Window” on page 559.

Snapshot Comparison

This task describes how to take a snapshot of a view, and then compare two snapshots of a specific view taken at different times.

This section includes the following tasks:

- “Take a Snapshot of a View” on page 558
- “Save Snapshots on a Periodic Basis” on page 558
- “Compare Snapshots” on page 558

1 Take a Snapshot of a View

Select **Applications > Topology View**. In View Explorer, right-click the required view and select **Save Snapshot** to take a snapshot of a view and save it. For details, see “Save Snapshot Dialog Box” on page 531.

2 Save Snapshots on a Periodic Basis

Optionally, you can schedule snapshots to be taken of a certain view at specific times by defining a task. For details, see “Job Scheduler Window” on page 495.

3 Compare Snapshots

Compare the snapshots of a view taken at different times. Select **Applications > Compliance > Compare Snapshots** to open the Compare Snapshots dialog box. For details on how to compare snapshots taken at different times, see “Compare Snapshots Window” on page 559.

Example of Snapshots of a View Taken at Different Times

In the following example, the **Deleted Item** icon next to the CI **new** in the right pane, indicates that the CI has been deleted in the newer view.

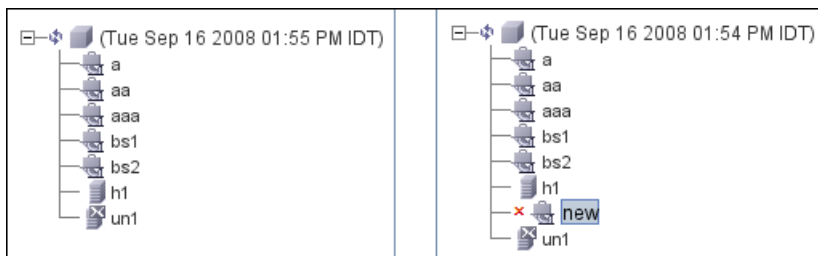

Compare Snapshots User Interface









This section describes:



- Compare Snapshots Window on page 559
- Find CI by Label Dialog Box on page 564
- Snapshots of <View> Dialog Box on page 565



Compare Snapshots Window

| | |
|------------------------------|--|
| Description | <p>Enables you to compare two snapshots of a specific view taken at different times. This feature enables you to visualize the differences between the views by comparing the statuses of the view at the times the snapshots were taken.</p> <p>You can compare a current snapshot to a previous snapshot or two snapshots both taken in the past.</p> <p>To access:</p> <ul style="list-style-type: none"> ➤ Select Applications > Compliance > Compare Snapshots. or ➤ Click View Snapshot in a Change report if a snapshot was taken of that view. For details, see “View Snapshot” on page 587. Only views with changes that reflect the differences between two snapshots, one taken before the From date and another snapshot taken before the To date in Change Report (for details, see “Change Report” on page 585), appear in the report. |
| Important Information | <ul style="list-style-type: none"> ➤ You can also define a schedule that takes snapshots of a specific view and saves them on a periodic basis. For details, see “Scheduler” on page 485. ➤ Snapshots of views that are marked as Track Changes (for details, see “Track Changes” on page 158), are created on a daily basis. |
| Included in Tasks | “Snapshot Comparison” on page 557 |

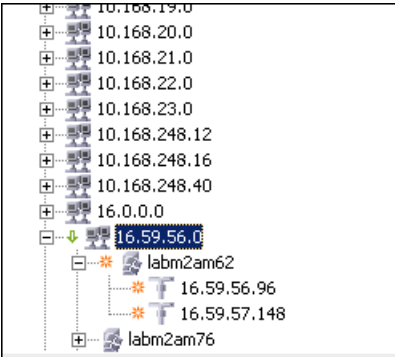
The following elements are included (unlabeled GUI elements are shown in angle brackets>):

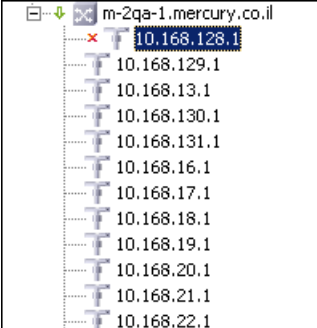
| GUI Element (A-Z) | Description |
|---|---|
|  | Expand the entire hierarchical tree structure of the CIs you selected. |
|  | Collapse the hierarchical tree structure of the CIs you selected. |
|  | Search for a CI within the selected view whose label contains the searched text. Opens the Find CI by label dialog box. |
|  | Find the next occurrence of an item marked as changed. |
|  | Find the previous occurrence of an item marked as changed. |
|  | <p>Show the difference between two configuration files. Compare what the configuration file looked like at the time each snapshot was taken.</p> <p>Click Select Snapshots to compare and select a view that contains a CI of the CIT configfile. Select a CI of the CIT Configuration File. A window opens displaying the differences in the configuration files, which are marked in blue.</p> |
|  | <p>Select a view that contains a CI of the CIT Configuration File and click Select Snapshots to compare. Select two snapshots and click Compare. Select a CI of the CIT Configuration File.</p> <p>Note: This button is only enabled if you selected a CI of the CIT Configuration File from the tree.</p> |
|  | <p>Display the selected CI's attributes. For details, see "Configuration Item Properties Dialog Box" on page 53.</p> <p>Note: The Properties functionality is sometimes displayed in a window and not in a tab.</p> |

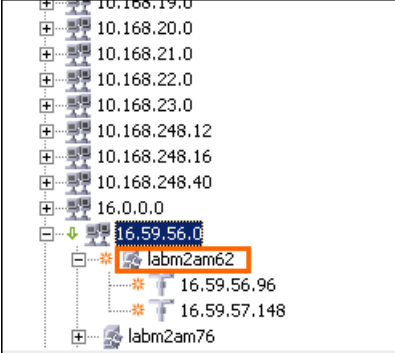
| GUI Element (A-Z) | Description |
|---|--|
|  | <p>The Contains an Updated Item icon indicates that either a new child CI was created for a CI or an existing child CI was updated or deleted.</p> <p>For example, the 16.59.56.0 CI in the figure below has a Contains an Updated Item icon due to the child CIs that were added to it.</p>  |
|  | <p>The Deleted Item icon indicates that a CI has been deleted from the view. For example, the figure below shows that the CI 10.168.128.1 has been deleted from the view.</p>  |

| GUI Element (A-Z) | Description |
|---|---|
|  | <p>The New Item icon indicates that a new CI has been added to the view. The example below shows that a Host and two IP CIs were added to the 16.59.56.0 Network CI.</p>  |
|  | <p>The Updated Item icon indicates that the attribute value of a CI has changed. For more information, see the Example of an Attribute Value of a CI that Has Changed on page 563.</p> |
| <p><At top of panes></p> | <p>The Compare Snapshots window is divided into two panes. Each side displays an hierarchical tree structure of all the CIs in the Topology Map for that snapshot version. The left side always represents the newer of the two versions. When you select a CI on one side, the corresponding CI on the other side is automatically selected (provided the Synchronize Selection check box is selected).</p> |
| <p>CIT</p> | <p>The name of the CIT to which the CI belongs as defined in the CI Type Manager, as described in “CI Type Manager” on page 205.</p> |
| <p>Name</p> | <p>The name of the CI as defined in the CI’s label.</p> |
| <p>Properties pane</p> | <p>Displays the attributes of the selected CI.</p> <p>The Properties pane contains the following fields:</p> <ul style="list-style-type: none"> ➤ Property. Displays the attributes for the selected CI. ➤ Value. Displays the attribute value for the currently selected CI. |

| GUI Element (A-Z) | Description |
|------------------------------------|---|
| Select Snapshots to compare | Select the two snapshots you want to compare. Opens the Snapshots of <view> dialog box. |
| Select View Name | Displays the name of the view whose snapshots you want to compare. Note: Only views for which snapshots have been taken are available. |
| Synchronize Selection | Enables you to select a CI on one side and have its corresponding CI automatically selected on the other side. The default for the Synchronize Selection check box is selected. Clearing this check box allows you to select two different CIs from each of the two trees. This allows you to compare two different CIs and see their different properties. |

Example of an Attribute Value of a CI that Has Changed

The **Updated Item** icon indicates that the attribute value of a CI has changed. For example, the figure below shows that the CI **labm2am09.devlab.ad** has the **Updated Item** icon because it was updated with a new **Host DNS Name** value (see the **Property** and **Value** columns in the bottom panes underneath the tree structure).

| Property | Value |
|---------------|---------------------|
| Host DNS Name | labm2am09.devlab.ad |
| Host Name | labm2am09 |

| Property | Value |
|---------------|-----------|
| Host DNS Name | labm2am09 |
| Host Name | labm2am09 |

Find CI by Label Dialog Box

| | |
|--------------------------|---|
| Description | <p>Search for a CI within the selected view whose label contains the searched text. You can specify a whole word or part of it. If a match is found, it selects the CI in the hierarchical tree structure in the Compare Snapshots window.</p> <p>To access: Click the Find  button in the Compare Snapshots window.</p> |
| Included in Tasks | “Snapshot Comparison” on page 557 |

The following elements are included (unlabeled GUI elements are shown in angle brackets>):

| GUI Element (A-Z) | Description |
|--------------------------|---|
| Backward | Do a backward search. |
| Case Sensitive | Distinguish between uppercase and lowercase characters. When you select Case Sensitive , search results only find those instances in which the capitalization matches the text you typed in the Text to find box. |
| Forward | Do a forward search. |
| Text to find | Enter the text of the CI you want to find. You can specify a whole word or part of it. |

Snapshots of <View> Dialog Box

| | |
|------------------------------|---|
| Description | This dialog box contains a list of all the different snapshots taken of the selected view. To access: Click Select Snapshots to compare in Compare Snapshots window. |
| Important Information | This dialog box opens only if you have taken snapshots of the view in the “Save Snapshot Dialog Box” on page 531. |
| Included in Tasks | “Snapshot Comparison” on page 557 |

The following elements are included (unlabeled GUI elements are shown in angle brackets>):

| GUI Element (A-Z) | Description |
|--------------------------|---|
| Description | The description you wrote for the snapshot in “Save Snapshot Dialog Box” on page 531. |
| Note | The note you wrote for the view in “Save Snapshot Dialog Box” on page 531. |
| Owner | The name of the user who took the snapshot. |
| Size | The number of CIs that were in the view when the snapshot was taken. |
| Time | The time at which the snapshot was saved. |

25

Compare CIs

This chapter provides information on Compare CIs.

This chapter includes:

Concepts

- ▶ CI Comparison Overview on page 567

Tasks

- ▶ CI Comparison on page 568

Reference

- ▶ Compare CIs User Interface on page 569

CI Comparison Overview

Compare CIs enables you to compare the hierarchies of two compound CIs. A compound CI is a CI that is linked to another CI by a **Container link** relationship.

You can display the compared CIs and their child CIs that appear in a selected view or in the CMDB.

Change indicators in the Compare CIs window denote:

- ▶ A CI in one pane does not match any corresponding CI in the other pane.
- ▶ A CI has a match but one of its children does not have a match.

You can only see differences in the attributes of the CI whose values have been defined as **Comparable** in the CI Type Manager. For information, see “Add/Edit Attribute Dialog Box” on page 217. For example, a comparison might show a difference in the operating system or disk capacity. For details on how to compare CIs, see “Compare CIs Window” on page 570.

CI Comparison

This task explains how to compare the hierarchies of two compound CIs, view a CI’s configuration file, and show the difference between two configuration files.

This section includes the following tasks:



- “Select the Required CIs” on page 568
- “View a CI’s Configuration File” on page 569
- “Show the Difference Between Two Configuration Files” on page 569

1 Select the Required CIs

Select the two CIs you want to compare. The hierarchies of the two compound CIs are compared in the Compare CIs window. You can choose to compare two CIs that appear in a selected view or in the CMDB. For details, see “Select CI Dialog Box” on page 573.

Example of Nonmatching CIs

The following example displays the **No Matching CI** icon next to the CIs **doc** and **doc1** because the CI on one side does not match the corresponding CI on the other side. The reason they do not match is the difference in document size. The value for **Document Size** for the **doc** CI on the left side is **10** while the **Document Size** for the **doc** CI on the right side is **20**.

|  |  | | | | | | | | | | | | | | | | | | | | | | | | |
|---|--|-------|-------------------|--|---------------|--|--------------------|-----|---------------|--|---------------|----|---|----------|-------|-------------------|--|---------------|--|--------------------|-----|---------------|--|---------------|----|
| CIT: Document Name: doc | CIT: Document Name: doc1 | | | | | | | | | | | | | | | | | | | | | | | | |
| <table border="1"> <thead> <tr> <th>Property</th> <th>Value</th> </tr> </thead> <tbody> <tr> <td>Document Checksum</td> <td></td> </tr> <tr> <td>Document Data</td> <td></td> </tr> <tr> <td>Document Extension</td> <td>txt</td> </tr> <tr> <td>Document Path</td> <td></td> </tr> <tr> <td>Document Size</td> <td>10</td> </tr> </tbody> </table> | Property | Value | Document Checksum | | Document Data | | Document Extension | txt | Document Path | | Document Size | 10 | <table border="1"> <thead> <tr> <th>Property</th> <th>Value</th> </tr> </thead> <tbody> <tr> <td>Document Checksum</td> <td></td> </tr> <tr> <td>Document Data</td> <td></td> </tr> <tr> <td>Document Extension</td> <td>txt</td> </tr> <tr> <td>Document Path</td> <td></td> </tr> <tr> <td>Document Size</td> <td>20</td> </tr> </tbody> </table> | Property | Value | Document Checksum | | Document Data | | Document Extension | txt | Document Path | | Document Size | 20 |
| Property | Value | | | | | | | | | | | | | | | | | | | | | | | | |
| Document Checksum | | | | | | | | | | | | | | | | | | | | | | | | | |
| Document Data | | | | | | | | | | | | | | | | | | | | | | | | | |
| Document Extension | txt | | | | | | | | | | | | | | | | | | | | | | | | |
| Document Path | | | | | | | | | | | | | | | | | | | | | | | | | |
| Document Size | 10 | | | | | | | | | | | | | | | | | | | | | | | | |
| Property | Value | | | | | | | | | | | | | | | | | | | | | | | | |
| Document Checksum | | | | | | | | | | | | | | | | | | | | | | | | | |
| Document Data | | | | | | | | | | | | | | | | | | | | | | | | | |
| Document Extension | txt | | | | | | | | | | | | | | | | | | | | | | | | |
| Document Path | | | | | | | | | | | | | | | | | | | | | | | | | |
| Document Size | 20 | | | | | | | | | | | | | | | | | | | | | | | | |

This example also illustrates that the **Document** group CI has a **Has a Non-Matching Child** icon because they have different child CIs.

2 View a CI's Configuration File

Select a CI of the CIT **Configuration File** and view the configuration file. For details, see “Compare CIs Window” on page 570.

3 Show the Difference Between Two Configuration Files

Select two CIs of the CIT **Configuration File** and view the difference between the two configuration files. For details, see “Compare CIs Window” on page 570.

Compare CIs User Interface

This section describes:





- Compare CIs Window on page 570
- Find CI by Label Dialog Box on page 572







► Select CI Dialog Box on page 573

Compare CIs Window

| | |
|------------------------------|---|
| Description | <p>Compare the hierarchies of two compound CIs. A compound CI is a CI that is linked to another CI by a Container link relationship.</p> <p>The Compare CIs window is divided into two panes. Each side displays a hierarchical tree structure of the CIs you selected. When you select a CI on one side, the corresponding CI on the other side is automatically selected, provided the Synchronize Selection check box is selected.</p> <p>To access: Select Applications > Compliance > Compare CIs.</p> |
| Important Information | You can compare only two CIs of the same CIT or one of the CIT's descendants in the hierarchy. |
| Included in Tasks | "CI Comparison" on page 568 |

The following elements are included (unlabeled GUI elements are shown in angle brackets>):

| GUI Element (A-Z) | Description |
|---|---|
|  | Expand the entire hierarchical tree structure of the CIs you selected. |
|  | Collapse the hierarchical tree structure of the CIs you selected. |
|  | Search for a CI within the selected view whose label contains the searched text. Opens the Find CI by label dialog box. |
|  | Find the next occurrence of an item marked as changed. For information on the change indicators, see "No Matching CI" on page 571 and "Has a Non-Matching Child" on page 571. |

| GUI Element (A-Z) | Description |
|--|--|
|  | Find the previous occurrence of an item marked as changed. For information on the change indicators, see “No Matching CI” on page 571 and “Has a Non-Matching Child” on page 571. |
|  | Show the difference between the content of the two configuration files. Configuration files use the .xml , .txt or .ini extensions. Select a CI of the CIT Configuration File in both panes and click the Show Differences button. A window opens displaying the differences in the configuration files, which are marked in blue. |
|  | View the content of a Configuration File CI. Select a CI of the Configuration File CI and click the Open button. Note: This button is only enabled if you selected a CI of the CIT Configuration File from the tree. |
|  | Display the selected CI’s properties. For details, see “Configuration Item Properties Dialog Box” on page 53. |
|  No Matching CI | Indicates that a CI in one pane does not match any corresponding CI in the other pane. |
|  Has a Non-Matching Child | Indicates that the child of the CI does not have a matching child in the other pane. |
| <At top of panes> | Displays the CIs you selected in the Select CI dialog box. |
| <Left and right panes> | Displays a tree of the compared CIs and their child CIs that appear in the selected view or in the CMDB, depending on whether you selected the View or the CMDB options. |
| CIT | The CIT (as defined in the CI Type Manager) of the selected CI at the top of the pane. For details, on CI Type Manager, see “CI Type Manager” on page 205. |
| CMDB | Display the selected CIs and their child CIs that appear in the entire CMDB. |
| Name | The name of the selected CI as defined in the CI’s label. |

| GUI Element (A-Z) | Description |
|------------------------------|--|
| Property | Displays the attribute name for the selected CI, which was marked as Comparable in the CI Type Manager. For details, see “Create Configuration Item Type/Relationship/Calculated Relationship Wizard” on page 226. |
| Select | Select the two CIs you want to compare. Opens the Select CI dialog box. The CI you select from the Select option on the left is displayed in the left pane and the CI you select from the Select option on the right is displayed in the right pane. |
| Synchronize Selection | Enables you to select a CI on one side and have its corresponding CI automatically selected on the other side. The default for the Synchronize Selection check box is selected. Clearing this check box allows you to select two different CIs from each of the two trees. This enables you to compare two different CIs and see their different properties. |
| Value | Displays the attribute value for the currently selected CI. |
| View | Display the selected CIs and their child CIs that appear in a specific view. |

Find CI by Label Dialog Box

| | |
|--------------------------|--|
| Description | Search for a CI within the selected view whose label contains the searched text. You can specify a whole word or part of it. If a match is found, it selects the CI in the hierarchical tree structure in the Compare CIs window. To access: Click the Find  button in the Compare CIs window. |
| Included in Tasks | “CI Comparison” on page 568 |

The following elements are included (unlabeled GUI elements are shown in angle brackets>):

| GUI Element (A-Z) | Description |
|-----------------------|--|
| Backward | Do a backward search. |
| Case Sensitive | Distinguish between uppercase and lowercase characters. When you select Case Sensitive , the search results only include those instances in which the capitalization matches the text you typed in the Text to find box. |
| Forward | Do a forward search. |
| Text to find | Enter the text of the CI you want to find. You can specify a whole word or part of it. |

Select CI Dialog Box

| | |
|--------------------|--|
| Description | Select the required CI for comparison from the hierarchical tree or search for a CI for comparison. To access: Click Select CI in the Compare CIs window. |
|--------------------|--|





The following elements are included (unlabeled GUI elements are shown in angle brackets>):

| GUI Element (A-Z) | Description |
|-------------------|--|
| Browse tab | Select the required CI for comparison from a hierarchical tree. For details, see “Browse Tab” on page 574 below. |
| Search tab | Search for a CI for comparison. For details, see “Search Tab” on page 574. |

Browse Tab

| | |
|--------------------|--|
| Description | Search for and display a view, and browse through the view to locate a particular CI. To access: Click Select CI to open the Select CI dialog box and click the Select CI tab. |
|--------------------|--|



The following elements are included (unlabeled GUI elements are shown in angle brackets):

| GUI Element (A-Z) | Description |
|---|---|
|  | Refresh the list of CIs (if new CIs have been added to a view). |
|  | Refresh the View list (if views have been newly defined). |
|  | Click to open the Select View dialog box. Select the view from which you want to select a CI. |
|  | Enables you to move to the next or previous result of the search for the string entered in the Find box. |
| <Hierarchical CI tree> | Displays the CIs from the selected view. |
| Find | Enter a CI name or a portion of a CI name in the Find box to locate a CI in the CI tree. |
| View | Select the required view from the list. |

Search Tab

| | |
|--------------------|--|
| Description | Search for a CI either in the entire CMDB or in the current view. You can also filter the list of CIs that is displayed. To access: Click Select CI to open the Select CI dialog box and click the Search tab. |
|--------------------|--|

The following elements are included (unlabeled GUI elements are shown in angle brackets>):

| GUI Element (A-Z) | Description |
|---|---|
|  | Click this to view the search results. The search results are displayed at the bottom of the Search tab. |
|  | Filter the list of CIs that is displayed. Click the Select CIs to search in button to open the hierarchical tree structure of the CI Type model. Select the required CIT. |
| CI Type | Search for a CI of a specified CI type. Click the  button to the right to open the hierarchical tree structure of the CI Type model. |
| Search for | Enter the name of the CI (or part of the name) you want to find. |

26

Asset Report

This chapter provides information on Asset reports.

This chapter includes:

Concepts

- ▶ Asset Report Overview on page 577

Reference

- ▶ Asset Report User Interface on page 577

Asset Report Overview

Asset reports display a list of all the CIs in a specified view, their attribute values, as well as their child CI's in the CMDB. You use Asset reports to view and analyze the contents of the view and focus on the data which is of interest to you. For example, an Asset report can display a list of all the servers that are part of a specific application contained in the view.

Asset Report User Interface

This section describes:

- ▶ Asset Report Page on page 578

 **Asset Report Page**

| | |
|------------------------------|---|
| Description | <p>An Asset report displays a list of all the CIs in a selected view and their attribute values, as well as their child CIs and their attribute values in the CMDB.</p> <p>The report contains only the attributes whose Asset Data check box was selected in the Attributes tab in the CI Type Manager. For more details, see “Add/Edit Attribute Dialog Box” on page 217.</p> <p>You can generate a list from a specific view or from the CMDB.</p> <p>When you generate an Asset report from a specific view, the report retains the same hierarchical structure as the relevant view in the Topology Map.</p> <p>To access: Select Applications > Reports > Asset Report.</p> |
| Important Information | <ul style="list-style-type: none"> ▶ Make sure that popups are not blocked in your browser. ▶ For details on how to work with reports, see “Working in Reports - Overview” in <i>Reference Information</i>. ▶ For information about limitations on the size of reports produced in .pdf format, see “Publishing a Report” in <i>Reference Information</i>. |

The following elements are included (unlabeled GUI elements are shown in angle brackets>):

| GUI Element (A-Z) | Description |
|--------------------------|--|
| CMDB | <p>Include information from the selected view as well as information about the child CIs and their attribute values in the CMDB.</p> <p>By choosing this option, the report includes CIs that are connected by the Container link relationship to the CIs in selected view. For example, the report would include the CPU and memory of a server that is contained in the view.</p> |

| GUI Element (A-Z) | Description |
|-------------------|--|
| Selected view | Select the required view. |
| Views | Includes only information about the CIs and their attributes contained in this view. |

27

Host Dependency Report

This chapter provides information on Host Dependency reports.

This chapter includes:

Concepts

- ▶ Host Dependency Report Overview on page 581

Reference

- ▶ Host Dependency Report User Interface on page 582

Host Dependency Report Overview

Host Dependency reports are based on TQL queries created in the Enrichment Manager, which use the relationship of the type Dependency. Dependency reports list all the relationships of the type Dependency that connect between servers in the selected view, or between the servers in the CMDB and the servers within the selected view.

The report includes relationships that:

- ▶ exist between databases and clients
- ▶ exist between clients and servers
- ▶ are created as a result of an MQ connection

Host Dependency Report User Interface

This section describes:

- Host Dependency Report Page on page 582

Host Dependency Report Page

| | |
|------------------------------|---|
| Description | <p>Enables you to generate a list of all the relationships of the type Dependency that connect between servers in the selected view, or between the servers in the CMDB and the servers within the selected view.</p> <p>To access: Select Applications > Reports > Host Dependency.</p> |
| Important Information | <ul style="list-style-type: none"> ► You can create new TQLs in Enrichment Manager using the Dependency relationship to describe the connection between hosts. Every new Dependency relationship that is used appears in the Dependency report. ► Make sure that popups are not blocked in your browser. ► For details on how to work with reports, see “Working in Reports” in <i>Reference Information</i>. |

The Host Dependency report page includes the following elements (listed alphabetically):

| GUI Element (A-Z) | Description |
|--------------------------|---|
| CMDB | Display all the servers in the CMDB that are dependent on the servers in the selected view. |
| Selected view | Select the required view. |
| Views | Display all the dependencies between the servers in the selected view. |

The following elements are included in the generated Host Dependency report (unlabeled GUI elements are shown in angle brackets>):

| GUI Element (A-Z) | Description |
|--------------------------|--|
| Clients | The list of clients that are linked to the servers. |
| Counter | The number of clients to which the server is connected. |
| Host | The servers in the selected view. |
| Relationship | The display label of the relationship in the Topology Map. |

28

Change Report

This chapter provides information on Change reports.

This chapter includes:

Concepts

- ▶ Change Report Overview on page 585

Reference

- ▶ Change Report User Interface on page 585

Change Report Overview

Change reports enable you to view and analyze the actual changes made to a specific CI and its children, or to a specific view. This can help with possible troubleshooting issues related to this CI. For example, seeing the changes that occurred to a CI might enable you to conclude that these changes are the cause of the problem. By the same token, the source of the troubleshooting issue could be related to expected changes which failed to occur.

Change Report User Interface

This section describes:

- ▶ Change Report Page on page 586
- ▶ CI History Report Page on page 590

 **Change Report Page**

| | |
|---------------------|---|
| Description | <p>Displays information about the changes made to the CIs whose properties are marked as either Change Monitored or Comparable. For details, see “Add/Edit Attribute Dialog Box” on page 217.</p> <p>To access: Select Applications > Reports > Change Report.</p> <p>The report displays:</p> <ul style="list-style-type: none"> ▶ Changes that occurred in a selected CI and all its children, which are linked, by default, by an <code>impact_link</code>. The CIs in the generated report are retrieved according to the Infrastructure Settings Manager settings. Go to Admin > Settings > Infrastructure Settings Manager > Applications > MamWeb. For details, see “Infrastructure Settings Manager” on page 453. ▶ Select Change Report relationship name to retrieve CIs that are linked by the selected calculated relationship. In the Value box, enter the name of the relationship as it appears in the Name box (not the Display Name box) in the Details page of the selected relationship in the CI Type Manager. For details, see “Details Page” on page 227. ▶ Select Change Report relationship qualifier to retrieve CIs that are defined with a qualifier. In the Value box, enter the name of the required qualifier. For information about qualifiers, see “Qualifiers Page” on page 230. ▶ Changes that occurred in all CIs in the selected view. In addition, this page displays any CIs that were added or deleted during the defined time frame according to snapshots taken of that view. ▶ CIs with a Container link relationship that were added to or removed from a CI. ▶ CIs whose relationship was defined with a TRACK_LINK_CHANGES qualifier, that were added to or removed from a CI. For information about qualifiers, see “Qualifiers Page” on page 230. |
| Useful Links | <p>For details on how to work with reports, see “Working in Reports” in <i>Reference Information</i>.</p> |

The following elements are included (unlabeled GUI elements are shown in angle brackets>):

| GUI Element (A-Z) | Description |
|----------------------------|---|
| Select CI/View | Select the required CI or view. Opens the Select CI/View dialog box. For details, see “Working with View Explorer” on page 669. |
| Use results on CMDB | The report displays the changes that occurred to the CI and its children in the entire CMDB. Note: This option is available only if you selected a CI and not a view. |
| Use results on View | The report displays the changes that occurred to the CI and its children in the selected view. Note: This option is available only if you selected a CI and not a view. |

The generated report includes the following elements (listed alphabetically):

| GUI Element (A-Z) | Description |
|------------------------|--|
| View Snapshot | Opens the Compare Snapshots dialog box. Enables you to perform a snapshot comparison. For details about snapshots, see “Compare Snapshots” on page 557. Note: This option is displayed only if, for the relevant view context, a snapshot was saved before the From date and another snapshot was saved before the To date, and there was a difference between them. |
| View Statistics | The statistics include the following: <ul style="list-style-type: none"> ▶ The number of CIs that were added to the view ▶ The number of CIs that were removed from the view ▶ The number of relationships that were added to the view ▶ The number of relationships that were removed from the view |

CI Changes Area

The following elements are included (unlabeled GUI elements are shown in angle brackets):

| GUI Element (A-Z) | Description |
|-------------------------------|--|
| <View other pages> | To view other pages, use the left and right arrows. The number between the left and right arrows indicate which pages are currently being displayed. For example, 1 - 2 of 3 means that the 1st and 2nd pages out of 3 are being displayed. |
| Change Date & Time | The date and time at which the change occurred. |
| Changer | The name of the user that manually modified the CI's property, or the name of the Discovery and Dependency Mapping (DDM) Probe that automatically discovered a change made to the CI's property. |
| CI Attribute | The name of the CI attribute that was changed. |
| CI Label | The label of the path from the root to the CI. Note: A backslash (\) in a CI name indicates a parent-child relationship with the format: <parent_CI>\<child_CI>. For example, the entry 16.59.63.0\Windows provides change information for the Windows CI which is the child of the 16.59.63.0 CI. Note: Click to view the change history of a specific CI. For details, see "CI History Report Page" on page 590. |
| CIT Name | The name of the CIT (internal). |
| New Value | The new value of the CI attribute. |
| Old Value | The previous value of the CI attribute (before the change). |
| Type | The type of change that occurred. |

Relationship Changes Area

The following elements are included (unlabeled GUI elements are shown in angle brackets>):

| GUI Element (A-Z) | Description |
|------------------------|---|
| Change Date | The date and time at which the update was performed. |
| Changer | The name of the user that manually modified the CI's property, or the name of the DDM probe that automatically discovered a change made to the CI's property. |
| Container Label | <p>The label of the path from the root to the container CI.</p> <p>A backslash (\) in a CI name indicates a parent-child relationship with the format: <parent_CI>\<child_CI>. For example, the entry 16.59.63.0\Windows provides change information for the Windows CI which is the child of the dancer.hp.com CI.</p> <p>Note: Double-click an item to view the change history of the container CI. For details, see "CI History Report Page" on page 590.</p> |
| Event type | <p>You can have one of the following values:</p> <ul style="list-style-type: none"> ▶ Add related CI. A contained CI was added to the container CI using a Container link relationship. ▶ Remove related CI. A contained CI that was linked to a container CI using a Container link was removed. |
| Related label | <p>The label of the path from the root to the contained CI.</p> <p>Note: Double-click an item to view the change history of the related CI. For details, see "CI History Report Page" on page 590.</p> |

 **CI History Report Page**

| | |
|------------------------------|---|
| Description | <p>Enables you to view all the changes in the properties of a specific CI or for CIs linked by a Container link relationship, from the time they were created.</p> <p>To access:</p> <ul style="list-style-type: none"> ▶ In the CI Changes area, click one of the links in the CI label column for the required CI. or ▶ In the Relationship Changes area, click one of the links in the Container label or Related label columns for the required CI. |
| Important Information | Make sure that popups are not blocked in your browser. |

The following elements are included (unlabeled GUI elements are shown in angle brackets>):

| GUI Element (A-Z) | Description |
|--------------------------|--|
| Change Date | The date and time when the update was performed. |
| Changer | The name of the user that manually modified the CI's property, or the name of the DDM probe that automatically discovered a change made to the CI's attribute. |
| CI Attribute | The name of the CI attribute that was updated. |
| New Value | The new value of the CI attribute. |

29

Topology Report

This chapter provides information on Topology reports.

This chapter includes:

Concepts

- ▶ Topology Report Overview on page 591

Tasks

- ▶ Generate and Send a Topology Report at Defined Intervals on page 592

Reference

- ▶ Topology Report User Interface on page 593

Topology Report Overview

A Topology report is based on a specific Report TQL query, defined in Topology Report Manager. It gives you information about the selected Report nodes in the TQL on which it is based.

Topology Report Manager enables you to customize the way the report is displayed. The information that appears in the report, including the order in which Report nodes are listed and their placement relative to other Report nodes, and how the information within each Report node is sorted, is defined in Topology Report Manager. For details, see “Topology Report Manager” on page 245.

You can generate a report and save it. The results of the generated report are saved in the History Results tab in the Topology Report page. For details, see “Topology Report Page” on page 594.

You can optionally schedule the Topology report to run on a periodic basis, For details, see “Generate and Send a Topology Report at Defined Intervals” on page 592.

Generate and Send a Topology Report at Defined Intervals

This section explains how to schedule a Topology report to be generated and sent to specific recipients, through email, at regularly defined intervals. The results of the scheduled reports are displayed in the History Results tab in the Topology Report page.

This task includes the following steps:

- ▶ “Configure a Favorite Filter” on page 592
- ▶ “Edit the Favorite Filter in Report Manager” on page 592
- ▶ “Send a Report at Specific Intervals” on page 593

1 Configure a Favorite Filter

Configure a Favorite Filter for the required Topology report. The filter is uploaded to the Report Manager. For details, see “Save Filter to Favorites Dialog Box” in *Reference Information*.

2 Edit the Favorite Filter in Report Manager

Edit the Favorite Filter in Report Manager to enable you to create a schedule to send the Favorite Filter to specified individuals at specific intervals.

In Report Manager, select the required Favorite Filter and then click the Edit  button to open the Favorite Filters wizard. In the Filter Setting page, select the **Save to History DB** option. For details, see “Favorite Filters Wizard” on page 605.

3 Send a Report at Specific Intervals

In Report Manager, create a schedule to send the Favorite Filter to specified individuals at specific intervals. The results of the scheduled reports are saved in the History Results tab in the Topology Report page.

For details on how to create a schedule, see “Create New Schedule Dialog Box” on page 613.

For details about the History Results tab, see “Topology Report Page” on page 594.

Topology Report User Interface

This section describes:

- Set Parameter Values Dialog Box on page 593
- Topology Report Page on page 594

Set Parameter Values Dialog Box

| | |
|-------------------------------------|---|
| <p>Description</p> | <p>Enables you to edit the predefined parameterized values of node conditions defined for the selected Report definition in Topology Report Manager.</p> <p>The dialog box displays all the conditions for the selected report definition. For each element, every condition appears on a separate line.</p> <p>To access: Click the Set parameter values link in the Topology Report page.</p> |
| <p>Important Information</p> | <p>The Set parameter values link appears only if you defined a node condition using parameterized values in the Attribute tab in the Node Condition dialog box in Topology Report Manager. For details, see “Attribute Tab” on page 377.</p> |

The following elements are included (unlabeled GUI elements are shown in angle brackets):

| GUI Element (A-Z) | Description |
|-------------------|--|
| <Attribute> | The attribute used for the attribute condition definition. |
| <Operator> | The operator used for the attribute condition definition. |
| Element name | The node for which the condition was defined using parameterized values. |
| Value | The required value. |

Topology Report Page

| | |
|------------------------------|---|
| Description | <p>A Topology report is based on a specific Report TQL query defined in Topology Report Manager. Each report is customized to display specific information, as defined in the relevant Report TQL. For details, see “Topology Report Manager” on page 245.</p> <p>To access: Select Applications > Reports > Topology Report.</p> |
| Important Information | <ul style="list-style-type: none"> ➤ For details on how to work with reports, see “Working in Reports” in <i>Reference Information</i>. ➤ For information about limitations on the size of reports produced in .pdf format, see “Publishing a Report” in <i>Reference Information</i>. |
| Included in Tasks | <p>“Generate and Send a Topology Report at Defined Intervals” on page 592</p> |

The Topology Report page includes the following panes:

- “Left pane” on page 595
- “Right pane” on page 596

Left pane

| | |
|--------------------|--|
| Description | Select the required Topology report definition you want to generate. |
|--------------------|--|

The following elements are included (unlabeled GUI elements are shown in angle brackets>):

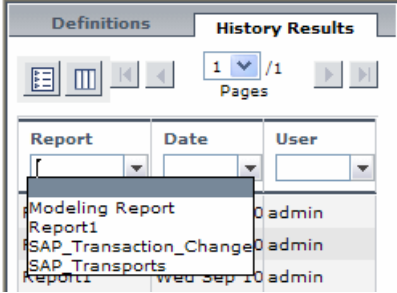
| GUI Element (A-Z) | Description |
|----------------------------|---|
| Definitions tab | Displays the hierarchical tree structure of the Topology reports defined in Topology Report Manager. For details, see “Topology Report Manager” on page 245. |
| History Results tab | <p>Displays the history of the Topology reports that were generated and saved using the Save to History DB option. This enables you to produce a Topology report that was generated at a specific time or a by a specific user.</p> <p>The Topology report you select in the Definitions tab is automatically selected in the History Results tab.</p>  <p>From the:</p> <ul style="list-style-type: none"> ➤ Report list, select the required Topology report. ➤ Date list, select the required time. ➤ User list, select the required user. <p>Note: For details on how to customize columns and divide a table of data or a list of reports into pages, see “Working in Reports” in <i>Reference Information</i>.</p> |

Right pane

| | |
|------------------------------|---|
| Description | Contains the information that was defined in Topology Report Manager to be included in the report. This includes which Report nodes should appear in the report, the parameter defined for each Report node, and the function you want to use to calculate the results on the report's columns. For details, see "Topology Report Manager" on page 245. |
| Important Information | For details on how to work with reports, see "Working in Reports" in <i>Reference Information</i> . |

The following elements are included (unlabeled GUI elements are shown in angle brackets>):

| GUI Element (A-Z) | Description |
|---------------------------------|--|
| Save to History DB | Enables you to generate and save a Topology report. The report results are stored in the History Results tab. |
| Set parameter values | (Optional) A link that opens the Set parameters values dialog box. Enables you to edit the predefined values of node conditions. Note: This link appears only if you defined a node condition using parameterized values in the Attribute tab in the Node Condition dialog box in Topology Report Manager. For details, see "Attribute Tab" on page 377. |
| Set view-specific report | (Optional) Enables you to generate a report of the selected Report TQL query based on a certain view rather than the entire CMDB. Select the view on which you want to base the report. Note: Click Clear to run the report based on the entire CMDB. |

30

Report Manager

This chapter includes the main concepts, tasks, and reference information for the Report Manager.

This chapter includes:

Concepts

- Report Manager Overview on page 598
- Favorite Filters on page 598
- Report Schedules on page 599

Tasks

- Work with the Report Manager — Workflow on page 600
- Work with the Report Manager — Scenario on page 601
- Create a Schedule on page 604

Reference

- Report Manager User Interface on page 605

Report Manager Overview

The Report Manager is a central location where you can manage selected report objects from throughout HP Universal CMDB. The Report Manager enables you to create and manage the following:

| Report or Report Object | Description |
|-------------------------|---|
| Favorite Filters | Used to regenerate a report with predefined filters. For details, see “Favorite Filters” on page 598. |
| Schedules | Schedule a report object to be sent to specified individuals at set times. For details, see “Report Schedules” on page 599. |
| Annotations | A snapshot of selected reports and highlight important areas of the report by drawing shapes, lines, and adding text to the snapshot. For details, see “Report Annotation” in <i>Reference Information</i> . Note: Annotations are created outside the Report Manager, in the specific report in which you are working. |
| Email | Send report objects to selected individuals using email. For details, see “Email Dialog Box” on page 611. |

Favorite Filters

Favorite Filters enable you to save a report filter and reuse it for future generating of the report. The filter you create can be used only for the same report for which it was created. Filters include the time range, location, views, CIs, and resource definitions configured for the report. For details on creating a Favorite Filter, see “Favorite Filters Wizard” on page 605.

You can also create a Favorite Filter from the specified report page. For details on the user interface for performing this task, see “Save Filter to Favorites Dialog Box” on page 84.

Report Schedules

You configure schedules to enable specified recipients to automatically receive reports, through email, at regularly defined intervals.

You can schedule Favorite Filters defined in the Report Manager, or reports saved from the specific report page.

For details on configuring report schedules, see “Create a Schedule” on page 604.

By default, the value that appears in the **From** field in the email containing the scheduled report is **UCMDB_Manager@<HP Universal CMDB server name>**. You can modify the value by selecting **Admin > Settings > Infrastructure Settings Manager** and the **Scheduled Reports** context in the **Foundations** tab. Modify the value **E-mail sender** or **Scheduled Reports e-mail sender address** (to include an email address in the **From** field). For details on modifying values, see “Infrastructure Settings Manager” on page 453.

To correctly view scheduled reports received in Microsoft Outlook 2003, in **Tools > Options > Security > Zone Settings**, select **Internet**; click **Custom Level** and specify the following settings in the Security Settings dialog box:

- **Download signed ActiveX control = Prompt**
- **Run ActiveX controls and plug-ins = Enable**
- **Script ActiveX controls marked safe for scripting = Enable**
- In the **Reset to** list, select **Medium**

Administrators can manage configured report schedules using the Report Schedule Manager tab, located at **Admin > Settings > Report Schedule Manager**. For details on managing report schedules using the Report Schedule Manager tab, see “Report Schedule Manager” on page 503.

Work with the Report Manager — Workflow

This task describes how to create, manage, and distribute reports using the Report Manager.

For a scenario of this task, see “Work with the Report Manager — Scenario” on page 601.

This task includes the following steps:

- “Create a Favorite Filter” on page 600
- “View a Report” on page 600
- “Email a Report” on page 600

1 Create a Favorite Filter

You can create a filter for reports, save it, and apply it to the specified report. For details on creating a Favorite Filter, see “Favorite Filters Wizard” on page 605.

2 View a Report



You can view a favorite filter or annotation by selecting the report object in the Report Manager table and clicking the **View Report** button on the Report Manager Main Page.

3 Email a Report

You can send a Favorite Filter to selected users using email. For details, see “Email Dialog Box” on page 611.

For details on how to create a schedule for a report object to be sent to specified individuals at set times, see “Create a Schedule” on page 604.

Work with the Report Manager — Scenario

This scenario describes how to create, manage, and distribute report objects using Report Manager.

For a task of this scenario, see “Work with the Report Manager — Workflow” on page 600.

This scenario includes the following steps:

- “Creating a Favorite Filter” on page 601
- “Emailing a Report” on page 602
- “Viewing a Report Saved to the Report Manager” on page 602

1 Creating a Favorite Filter

John Smith is the CEO for ABC Software Company. He wants to see the data output of the Change report for a specific CI for the past month. He clicks the **New Favorite Filter** button. In the Favorite Filters Wizard, he configures a Favorite Filter by selecting the report he wants to view, and configures the Time Range bar to generate the report displaying all the changes that occurred for that CI, resource, or view during the defined time range.



The report generated by the Favorite Filter appears as follows:

Change Report for 10.168.100.0 - Last refresh at Sun Jul 20, 2008 02:07 PM

View: From: 6/20/08 2:07 PM To: 7/20/08 2:07 PM (GMT+02:00)...

Select CI / View: 10.168.100.0

Use results on CMDB View

CI changes 1 / 1 Pages

| Type | CI label | CIT Name | CI attribute | New Value | Old Value | Change Date | Changer |
|------------|--------------------|----------|----------------|---------------------|---------------------|------------------|--------------------|
| Updated CI | 10.168.100.0(Unix) | Unix | Host Boot Time | Fri Apr 18, 2008 08 | Fri Apr 18, 2008 08 | 7/16/08 7:07 PM | UCMDBDiscovery: Ho |
| Updated CI | 10.168.100.0(Unix) | Unix | Host DNS Name | labm1rac02 | | 7/17/08 11:21 AM | UCMDBDiscovery: DN |
| Updated CI | 10.168.100.0(Unix) | Unix | Host Boot Time | Fri Apr 18, 2008 08 | Fri Apr 18, 2008 08 | 7/17/08 11:25 AM | UCMDBDiscovery: Ho |
| Updated CI | 10.168.100.0(Unix) | Unix | Host Boot Time | Fri Apr 18, 2008 08 | Fri Apr 18, 2008 08 | 7/18/08 11:36 AM | UCMDBDiscovery: Ho |
| Updated CI | 10.168.100.0(Unix) | IP | Display Label | 16.59.60.154 | | 7/17/08 11:21 AM | UCMDBDiscovery: DN |
| Updated CI | 10.168.100.0(Unix) | Unix | Host Boot Time | Sun Oct 7, 2007 02 | Sun Oct 7, 2007 02 | 7/16/08 7:03 PM | UCMDBDiscovery: Ho |
| Updated CI | 10.168.100.0(Unix) | Unix | Host DNS Name | labm1rac01 | | 7/17/08 11:21 AM | UCMDBDiscovery: DN |
| Updated CI | 10.168.100.0(Unix) | Unix | Host Boot Time | Sun Oct 7, 2007 02 | Sun Oct 7, 2007 02 | 7/17/08 11:32 AM | UCMDBDiscovery: Ho |
| Updated CI | 10.168.100.0(Unix) | Unix | Host Boot Time | Sun Oct 7, 2007 02 | Sun Oct 7, 2007 02 | 7/20/08 11:25 AM | UCMDBDiscovery: Ho |
| Updated CI | 10.168.100.0(Unix) | IP | Display Label | 16.59.60.164 | | 7/17/08 11:21 AM | UCMDBDiscovery: DN |

Relationship changes 1 / 2 Pages

| Container label | Event type | Related label | Change Date | Changer |
|---------------------------|----------------|-------------------------|------------------|---------------------------------|
| 10.168.100.0 (Network) | Add Related CI | labm1rac02(unix) | 7/17/08 11:25 AM | UCMDBDiscovery: Host Connection |
| 10.168.100.0 (Network) | Add Related CI | (ip) | 7/17/08 11:25 AM | UCMDBDiscovery: Host Connection |
| 10.168.100.0 (Network) | Add Related CI | labm1rac01(unix) | 7/17/08 11:32 AM | UCMDBDiscovery: Host Connection |
| 10.168.100.0 (Network) | Add Related CI | (ip) | 7/17/08 11:32 AM | UCMDBDiscovery: Host Connection |
| 10.168.100.0(Unix (Unix)) | Add Related CI | 001321B36815(interface) | 7/16/08 7:00 PM | UCMDBDiscovery: Host Connection |

2 Emailing a Report

John wants to send a Change report to an associate to show him the data that has been collected. He selects the Change report in the Report Manager and clicks the **Send Email Now** button to choose a recipient from the Email dialog box and send the report using email.



3 Viewing a Report Saved to the Report Manager

One of John's associates has saved an annotated report to the Report Manager, and John wants to view the areas in the report that have been highlighted by the annotations. He selects the annotation in the Report Manager and clicks the **View Report** button to view the report's annotations.



The resulting Report Manager page appears as follows:

| Name | Type | Details | Description | Privilege | Owner | Scheduling |
|--------------------------|------------------|-------------------|-------------|-----------|-------|-----------------------------|
| change1 | Favorite Filter | Change Report | | Public | - | 2 active schedules out of 2 |
| change2 | Favorite Filter | Change Report | | Public | - | |
| change3 | Favorite Filter | Change Report | | Public | - | |
| change5 | Favorite Filter | Change Report | | Public | - | |
| change7 | Annotated Report | Change Report | | Public | - | |
| Changed Applications | Favorite Filter | Changed Applicat | | Public | - | |
| CMDB Util | Favorite Filter | CMDB Utilization | | Public | - | |
| Network Device Breakdown | Favorite Filter | Network Device Br | | Public | - | |

The annotated report appears, with annotations indicated by black and pink boxes, as follows:

CI changes

| Type | CI label | CIT Name | CI attribute | New Value | Old Value | Change Date | Changer |
|-------------|----------------------------------|----------|----------------------|---|-----------|------------------|---------------------|
| Updated CI: | 10.0.0.0\Windows | IP | Display Label | 16.59.58.37 | | 7/17/08 11:21 AM | UCMDBDiscovery: DN: |
| Updated CI: | 10.0.0.0\Windows | IP | Display Label | 16.59.57.83 | | 7/17/08 11:20 AM | UCMDBDiscovery: DN: |
| Updated CI: | 10.0.0.0\Windows | Windows | Host Root Time | Tue Jul 1, 2008 05: Tue Jul 1, 2008 05: | | 7/16/08 7:07 PM | UCMDBDiscovery: Ho: |
| Updated CI: | 10.0.0.0\Windows | Windows | Host DNS Name | labm2vm15 | | 7/17/08 11:20 AM | UCMDBDiscovery: DN: |
| Updated CI: | 10.0.0.0\Windows | Windows | Host PC Manufacturer | VMware, Inc. | | 7/17/08 11:20 AM | UCMDBDiscovery: Ho: |
| Updated CI: | 10.0.0.0\Windows | Windows | Host Model | VMware Virtual Platf | | 7/17/08 11:20 AM | UCMDBDiscovery: Ho: |
| Updated CI: | 10.0.0.0\Windows | Windows | Host OS domain name | WORKGROUP | | 7/17/08 11:20 AM | UCMDBDiscovery: Ho: |
| Updated CI: | 10.0.0.0\Windows | Windows | Host Operating Sys | erver enterprise ec | | //17/08 11:20 AM | UCMDBDiscovery: Ho: |
| Updated CI: | 10.0.0.0\Windows | Windows | Host Operating Sys | 3790 | | 7/17/08 11:20 AM | UCMDBDiscovery: Ho: |
| Updated CI: | 10.0.0.0\Windows | Windows | Host Operating Sys | 5.2.3790 | | 7/17/08 11:20 AM | UCMDBDiscovery: Ho: |

Relationship changes

| Container label | Event type | Related label | Change Date | Changer |
|------------------------------------|----------------|--------------------------------|------------------|-------------------------------|
| 10.0.0.0 (Network) | Add Related CI | _abm2vm15(int) | 7/17/08 11:20 AM | UCMDBDiscovery: Host Connecto |
| 10.0.0.0 (Network) | Add Related CI | _ip | 7/17/08 11:20 AM | UCMDBDiscovery: Host Connecto |

Create a Schedule

This task describes how to schedule a favorite filter from the Report Manager main page.

This task includes the following steps:

- “Prerequisites” on page 604
- “Create a Schedule” on page 604
- “Results” on page 604

1 Prerequisites

Ensure that you have at least one Favorite Filter in the Report Manager. For details on configuring Favorite Filters, see “Work with the Report Manager — Workflow” on page 600.

2 Create a Schedule



- a Click the **Create new schedule for selected reports** button.
- b Enter the requested information in the Create New Schedule dialog box. For details on creating a new schedule in the Create New Schedule Dialog Box, see “Create New Schedule Dialog Box” on page 613.

3 Results

The configured schedule’s status is indicated in the **Scheduling** column of the Report Manager.

Click the link in the **Scheduling** column to open the Schedule Management dialog box and manage the configured schedules. For details on the Schedule Management dialog box, see “Schedule Management Dialog Box” on page 614.

Report Manager User Interface

This section describes:

- Favorite Filters Wizard on page 605
- Report Manager Main Page on page 608

Favorite Filters Wizard

| | |
|--------------------------|---|
| Description | Enables you to create a predefined filter with which you can regenerate the specified report. To access: Click the New Favorite Filter button  in the Report Manager. |
| Included in Tasks | “Generate Reports” on page 63 |
| Wizard Map | The Favorite Filters Wizard contains: Filter Properties Page > Filter Setting Page > Report Preview Page |

Filter Properties Page

| | |
|------------------------------|--|
| Description | Enables you to choose the report for which you want to assign a Favorite Filter, and to configure the name, description, and access level of the filter. To access: Click the New Favorite Filter button  in the Report Manager. |
| Important Information | General information about the wizard is available at “Favorite Filters Wizard” on page 605. |
| Wizard Map | Filter Properties Page > Filter Setting Page > Report Preview Page |

The following elements are included (unlabeled GUI elements are shown in angle brackets):

| GUI Element (A-Z) | Description |
|---------------------------|--|
| Filter description | Optionally, enter a description for the filter. |
| Filter name | Enter a descriptive name for the filter. |
| Save filter as | Choose the access level for the favorite filter: <ul style="list-style-type: none"> ▶ Private. The filter is available only to the user who configured it, or to an administrator. ▶ Public. The filter is available to any user with appropriate permissions. |
| Select report | Click to select from the list of reports from which you can assign a Favorite Filter. |

Filter Setting Page

| | |
|------------------------------|---|
| Description | Enables you to configure parameters for the filter. To access: Click the New Favorite Filter button  in the Report Manager. |
| Important Information | General information about the wizard is available at “Favorite Filters Wizard” on page 605. |
| Wizard Map | Filter Properties Page > Filter Setting Page > Report Preview Page |

The following elements are included:

| GUI Element (A-Z) | Description |
|-------------------|--|
| <Filters> | The active filters displayed on the Filter Setting page depend on the report you have chosen. The various filter options are described in the documentation for the specific report you are viewing. |
| Time Range | Choose the date and time frame for the filter. For details, see “Time Range Bar” in <i>Reference Information</i> . |

Select CI/View Dialog Box

| | |
|------------------------------|---|
| Description | Select the required CI or view. Opens the Select CI/View dialog box. For details, see “Working with View Explorer” in <i>Model Management</i> . To access: Click the CI/View link. |
| Important Information | The CI/View link is available only in the Change report. |

Set View-specific Report Dialog Box

| | |
|------------------------------|--|
| Description | Enables you to generate a report of the selected Report TQL query based on a specific view rather than the entire CMDB. To access: Select the Favorite Filter of a Topology report and click the Edit button  . In the Filter Settings page, click the Set View-Specific Report link. |
| Important Information | The Set View-specific Report link is available only in Topology reports. |

Save to History DB Option

| | |
|------------------------------|--|
| Description | Enables you to create a schedule to send the Favorite Filter to specified individuals at specific intervals. To access: Select the Favorite Filter of a Topology report and click the Edit button  . In the Filter Settings page, select the Save to History DB option. |
| Important Information | The Set View-specific Report link is available only in Topology reports. |

Selected View Dialog Box

| | |
|------------------------------|---|
| Description | Select the required view. Opens the Selected View dialog box. To access: Click the Selected View link. |
| Important Information | The Selected View link is available only in Asset, Host Dependency, or Change reports. |









Report Preview Page

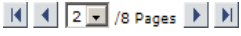





| | |
|------------------------------|--|
| Description | <p>Displays a snapshot of the generated report, based on the parameters configured for the filter.</p> <p>To access: Click the New Favorite Filter button  in the Report Manager.</p> |
| Important Information | <ul style="list-style-type: none"> ▶ The Report Preview Page only displays the report and does not enable any functionality on the report snapshot. ▶ General information about the wizard is available at “Favorite Filters Wizard” on page 605. |
| Wizard Map | Filter Properties Page > Filter Setting Page > Report Preview Page |

Report Manager Main Page

| | |
|------------------------------|--|
| Description | <p>Enables you to manage the contents of the Report Manager and perform a variety of actions, including:</p> <ul style="list-style-type: none"> ▶ View, edit, and clone existing components. ▶ Configure Favorite Filters. ▶ Email Favorite Filters. ▶ Create a schedule for selected reports to run. <p>To access: Select Application > Reports > Report Manager.</p> |
| Important Information | You can filter the contents of the Report Manager by entering or selecting values in the cells under each column heading. |
| Useful Links | “Annotation Tool Window” on page 67 |

The following elements are included:

| GUI Element (A–Z) | Description |
|---|--|
|  | Click to view the selected annotated report or Favorite Filter. |
|  | <p>Divides a table of data into pages. You move from page to page by clicking the relevant button:</p> <ul style="list-style-type: none"> ▶ To view more items, click the Next page or Last page buttons. ▶ To view previous items in the list, click the Previous page or First page buttons. |
|  | Click to create a filter to be applied to reports. For details, see “Favorite Filters Wizard” on page 605. |
|  | <p>Click to edit the selected Favorite Filter.</p> <p>Note: When selecting a Favorite Filter, clicking this button opens the Favorite Filter wizard.</p> |
|  | <p>Click to create a copy of the report or report object. When copying a Favorite Filter, you can then edit parameters in the wizard of the Favorite Filter.</p> <p>Note: Any schedules configured for a specific Favorite Filter are not cloned when selecting this option.</p> |
|  | <p>Click to delete the report object.</p> <p>Note: Deleting a Favorite Filter causes all schedules configured for the Favorite Filter to also be deleted.</p> |
|  | Click to email the selected report object. For details, see “Email Dialog Box” on page 611. |
|  | Click to create a schedule to send the report object to specified individuals at specific intervals. For details, see “Create New Schedule Dialog Box” on page 613. |
|  | Click to open the Schedule Management dialog box and manage schedules configured for the selected report object. For details, see “Schedule Management Dialog Box” on page 614. |

| GUI Element (A–Z) | Description |
|---|---|
|  | Click to delete all schedules from the Favorite Filter. |
|  | Click to resume all schedules for the Favorite Filter. |
|  | Click to pause all schedules for the Favorite Filter. |
|  | Click to refresh the Report Manager page. |
|  | Click to reset the width of the columns to the default setting. |
|  | Click to select columns to be visible in the table. For details, see “Working with Tables” in <i>Reference Information</i> . |
| Description | The description of the report object. The value of this field is entered as entered during configuration of the report object. |
| Details | Displays the name of the report (value of the Report Name field) with which the Filter is associated. |
| Name | The name of the Favorite Filter or annotated report. |
| Owner | The user who created the report object. |
| Privilege | <p>The privilege level of the report or report object. The available values are:</p> <ul style="list-style-type: none"> ▶ Private. The report or report object is available only to the user who configured it, or an administrator. ▶ Public. The report or report object is available to administrators or any user with appropriate permissions. |

| GUI Element (A-Z) | Description |
|-------------------|--|
| Scheduling | <p>Indicates if schedules are configured for the selected report or filter, and displays a link to the list of schedules (if they exist).</p> <p>Click the indicated schedules link to open the Schedules Management dialog box and manage schedules for the selected item. For details on the user interface, see “Schedule Management Dialog Box” on page 614.</p> |
| Type | The type of report object displayed. |

Email Dialog Box

| | |
|--------------------|---|
| Description | <p>Enables you to send the selected report object using email.</p> <p>To access: Click the Email button  on the Report Manager Main Page.</p> |
|--------------------|---|



The following elements are included (unlabeled GUI elements are shown in angle brackets>):

| GUI Element (A-Z) | Description |
|------------------------|---|
| Attachment type | <p>Select the type of report attachment to be used. The available attachment types are:</p> <ul style="list-style-type: none"> ▶ Embedded. The favorite filter or annotated report is embedded into the body of the email. ▶ Attached. The favorite filter or annotated report is sent as an external attachment with the email. ▶ Zipped. The favorite filter or annotated report is sent as a .zip file attachment. |
| Format | Select the format of the report. |



| GUI Element (A-Z) | Description |
|------------------------|---|
| Recipients | Section of the Email dialog box that enables you to select recipients to receive the email. For details, see “Recipients Area” on page 612. |
| Select language | Select the language of the report attachment. The server from which the schedule is being sent must support the selected language for the report to display properly. |

Recipients Area

The following elements are included:

| GUI Element (A-Z) | Description |
|---|--|
|  | Click to move recipients to the Selected Recipients pane. You must select recipients in the Available Email Recipients pane before clicking this button. |
|  | Click to de-select recipients by highlighting and move them to the Available Email Recipients pane. You must highlight recipients in the Selected Recipients pane before clicking this button. |
| Available Email Recipients | The list of configured recipients who are currently not selected to receive email on the report object. |
| New Recipient | Click to add a new recipient to receive email of the report object. For details, see “Recipient Dialog Box” on page 508. |
| Selected Recipients | The list of configured recipients who are currently selected to receive email on the report object. |

Create New Schedule Dialog Box

| | |
|--------------------------|---|
| Description | <p>Enables you to schedule a report object to be sent to specified individuals at specific intervals.</p> <p>To access:</p> <ul style="list-style-type: none"> ▶ Click the Create new schedule for selected reports button  on the Report Manager main page. ▶ Click the New button  in the Schedules Management dialog box, accessible by clicking the listed schedules in the Scheduling column. <p>Note: This dialog box is also accessible by navigating to Admin > Settings > Report Schedule Manager, and clicking the Edit Selected Schedule  button. For details on the Report Schedule Manager, see “Report Schedule Manager” on page 503.</p> |
| Included in Tasks | “Create a Schedule” on page 604 |
| Useful Links | “Report Schedules” on page 599 |

The following elements are included (unlabeled GUI elements are shown in angle brackets>):







| GUI Element (A–Z) | Description |
|----------------------------|--|
| Range of recurrence | <p>Configure the start and end time of the schedule, as follows:</p> <ul style="list-style-type: none"> ▶ Start. Click to configure the date for the schedule to start. ▶ No end date. Select for the schedule to run indefinitely. ▶ End by. Click to configure the date for the schedule to end. |
| Recipients | Configure recipients to receive the report at the scheduled time. For details on configuring recipients, see “Recipients Area” on page 612. |
| Recur every day on | Select the days of the week on which the report is to run. |

| GUI Element (A–Z) | Description |
|-------------------------------|---|
| Recurrence Pattern | <p>Enables you to select how often the report object is to be sent.</p> <p>You also select the following configurations:</p> <ul style="list-style-type: none"> ▶ How often the report is to run. Choose from: <ul style="list-style-type: none"> ▶ Daily ▶ Weekly ▶ Monthly ▶ Quarterly ▶ Days of the week the report is to run, if you chose Daily or Weekly. ▶ The first or last day of every month or quarter, if you chose Monthly or Quarterly. ▶ The specific day of the month or quarter, if you chose Monthly or Quarterly. |
| Report generation time | <p>Set the time for the report generation to begin, and the time zone in which the generation should take place.</p> |
| Select language | <p>Select a language for the schedule to be sent.</p> <p>Note: The server from which the schedule is being sent must support the selected language for the report to display properly.</p> |
| Time Zone | <p>Select a time zone according to whose time the schedule is to be sent.</p> |

Schedule Management Dialog Box

| | |
|---------------------|---|
| Description | <p>Enables you to manage configured schedules.</p> <p>To access:</p> <ul style="list-style-type: none"> ▶ Click the link in the Scheduling column next to the relevant item on the Report Manager Main Page. ▶ Click the Manage schedules list button  on the Report Manager Main Page. |
| Useful Links | <p>“Create New Schedule Dialog Box” on page 613</p> |

The following elements are included:

| GUI Element (A–Z) | Description |
|---|--|
|  | Click to create a new schedule for the selected report object. For details on creating schedules, see “Create New Schedule Dialog Box” on page 613. |
|  | Click to resume the selected schedule according to its configured running time. |
|  | Click to pause the selected schedule. |
|  | Click to delete the selected schedule. Note: Deleting the schedule does not delete the report object. |
| Generation Time | The time (in the indicated time zone) that the schedule is to be generated. |
| Recipients | The recipients configured to receive the selected schedule. |
| Recurrence | The recurrence pattern for the selected schedule. |
| Status | The current status of the schedule, displayed with an icon indicating one of the following statuses: <ul style="list-style-type: none"> ➤ Active.  ➤ Paused.  Note: If an error status is indicated, see the scheduler log located in: <HP Universal CMDB root directory>UCMDBServer\j2f\log\EJBContainer\scheduler\scheduler.log |

31

Overview Reports

This chapter provides information on Overview reports.

This chapter includes:

Concepts

- ▶ Overview Reports Overview on page 617

Reference

- ▶ Overview Reports User Interface on page 618

Overview Reports Overview

Overview reports consist of charts and tables that help you track and analyze the health of your monitored environment.

Overview reports enable you to view and assess performance data collected by HP Universal CMDB and stored in the CMDB. When generating reports, you can specify various report settings, such as time range or location, as well as drill down to see further information.

Note: You must have Adobe Flash Player version 8.0 or later installed on your machine to view Overview reports. For details, see “Viewing Reports with Adobe Flash Player” in *Reference Information*.

Overview Reports User Interface

This section describes:

- ▶ Changed Applications Report on page 619
- ▶ Changed Views Report on page 621
- ▶ CMDB Utilization Report on page 623
- ▶ Database Breakdown Report on page 624
- ▶ Delete Candidates Overview Report on page 626
- ▶ Generic Breakdown Report on page 628
- ▶ Host OS Breakdown Report on page 631
- ▶ Major Application Type Breakdown Report on page 632
- ▶ Network Device Breakdown Report on page 634
- ▶ Number of Changes Report on page 635

Changed Applications Report

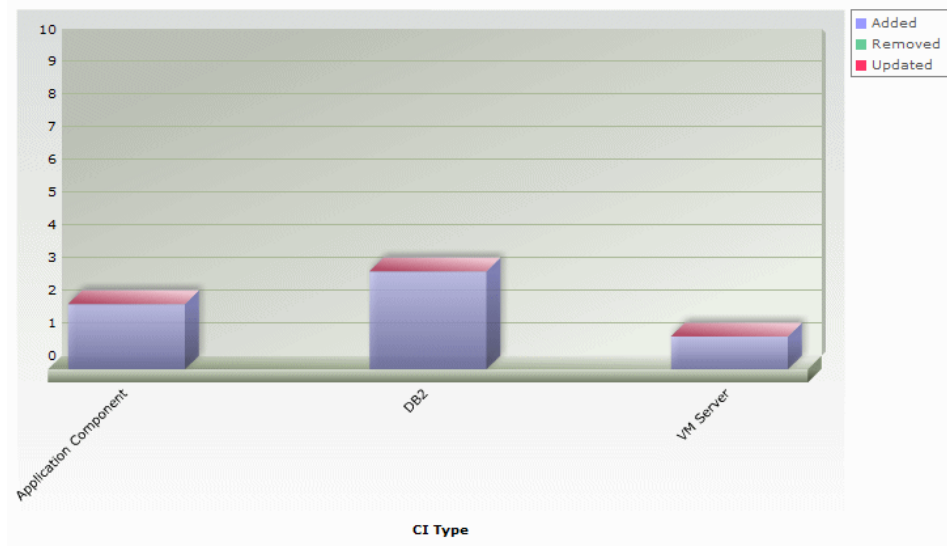

Description

This report displays a bar graph showing the number of detected changes in applications within a defined period.

Each bar represents a different application type. The colors in each bar represent the different types of changes that occurred in the application. Each color in the legend at the right of the bar graph represents a different type of change. The CI type of each application is displayed under the bar.

You can display the number of each type of change that occurred by moving the cursor over the related color. The tooltip that appears displays the relevant number of changes that occurred.

Click the relevant color in the bar to drill down to see a Show CI Instances report displaying the application instances that represent the changes.

To access: Select **Applications > Overview Reports > Changed Applications**.

| | |
|------------------------------|---|
| Important Information | <ul style="list-style-type: none">▶ You must have Adobe Flash Player version 8.0 or later installed on your machine to view Overview reports. For details, see “Viewing Reports with Adobe Flash Player” in <i>Reference Information</i>.▶ For information about limitations on formatting reports, see “Formatting a Report” in <i>Reference Information</i>. |
| Useful Links | For details on how to work with reports, see “Working in Reports” in <i>Reference Information</i> . |

Changed Views Report

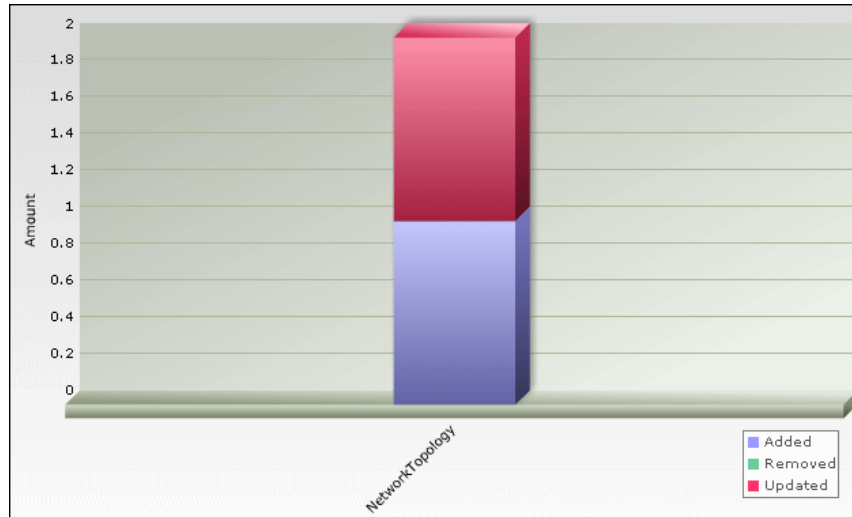

Description

This report displays a bar graph showing the number of changes that occurred in a specific view within a defined period.

Note: Only views with changes that reflect the differences between two snapshots, one taken before the **From** date and another snapshot taken before the **To** date in Change Report appear in the report.

Each bar represents a different view. The bar graph displays up to ten views with the largest number of changes. The view name is displayed under the bar. The legend at the right side of the bar graph shows which color represents the type of change that occurred. You can display the number of each type of change by moving the cursor over the relevant color. The tooltip that appears displays the name of the view and the number of changes that occurred.

To access: Select **Applications > Overview Reports > Changed Views**.

| | |
|------------------------------|---|
| Important Information | <ul style="list-style-type: none">▶ You must have Adobe Flash Player version 8.0 or later installed on your machine to view Overview reports. For details, see “Viewing Reports with Adobe Flash Player” in <i>Reference Information</i>.▶ For information about limitations on formatting reports, see “Formatting a Report” in <i>Reference Information</i>. |
| Useful Links | <ul style="list-style-type: none">▶ For details on how to work with reports, see “Working in Reports” in <i>Reference Information</i>.▶ For details on Change reports, see “Change Report” on page 585. |

CMDB Utilization Report

| Type | Amount |
|------------------------|---------|
| CIs and Relationships | 203,050 |
| Correlation Rules | 2 |
| Enrichment Rules | 18 |
| Reports | 2 |
| Running Discovery Jobs | 34 |
| Snapshots | 0 |
| Views | 44 |

| | |
|---------------------|--|
| Description | <p>This report displays general CMDB statistics.</p> <p>For example, the statistics can contain the number of Correlation rules created, how many CIs there are in the CMDB, or how many snapshots have been taken.</p> <p>To access: Select Applications > Overview Reports > CMDB Utilization.</p> |
| Useful Links | <p>For details on how to work with reports, see “Working in Reports” in <i>Reference Information</i>.</p> |

Database Breakdown Report

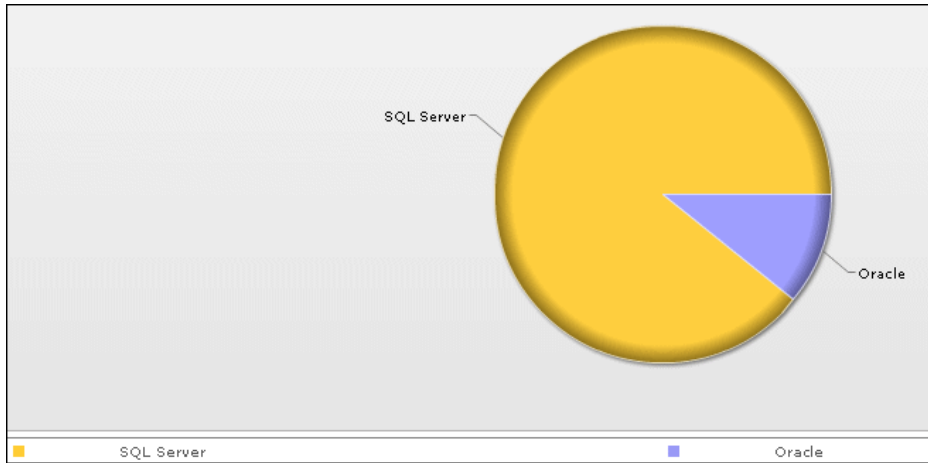

Description

This report displays a pie chart showing the breakdown of database types and versions. You can view all databases deployed in the system or databases at a certain location.

To view the available databases at a specific location, select the required country, state, and city in which the hosts that the databases are connected to are located.

To verify the database types, use the legend below the pie chart.

Click a segment to view a specific database type sorted by version.

You can display the number of each database version by moving the cursor over the related color. The tooltip that appears displays the relevant number.

Click a pie slice to drill down to see a Show CI Instances report for each database version.

To access: Select **Applications > Overview Reports > Database Breakdown**.

| | |
|------------------------------|---|
| Important Information | <ul style="list-style-type: none">▶ You must have Adobe Flash Player version 8.0 or later installed on your machine to view Overview reports. For details, see “Viewing Reports with Adobe Flash Player” in <i>Reference Information</i>.▶ For information about limitations on formatting reports, see “Formatting a Report” in <i>Reference Information</i>. |
| Useful Links | For details on how to work with reports, see “Working in Reports” in <i>Reference Information</i> . |

Delete Candidates Overview Report

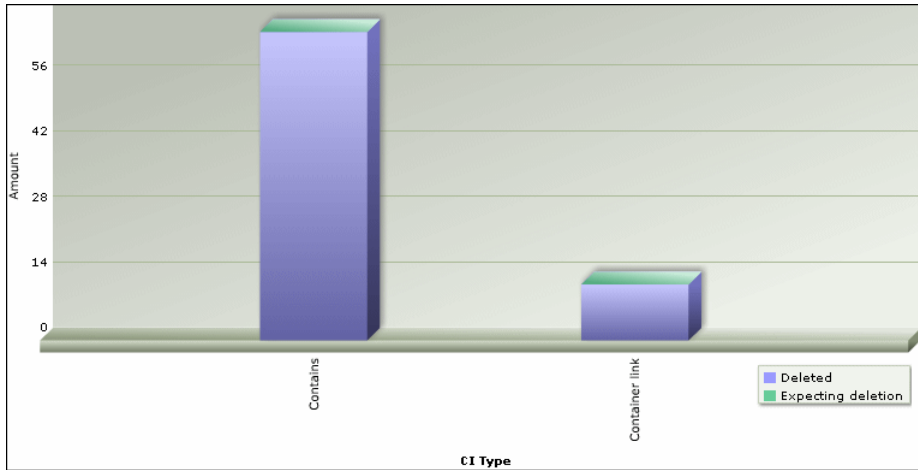

| | |
|---------------------------|--|
| <p>Description</p> | <p>This report displays a bar graph showing the CITs and relationships that were deleted within a defined period, and the ones that are about to be deleted.</p> <p>Each bar represents the CIT of a CI or a relationship. The legend at the right side of the bar graph shows which color represents the CIs and relationships that were deleted and which color represents those that are about to be deleted. The CI type of each CI or relationship is displayed under the bar.</p> <p>You can display the number of CIs and relationships that were deleted and the ones that are about to be deleted by moving the cursor over the related color in the bar. The tooltip that appears displays the relevant number.</p> <p>Click a bar to drill down to see a Show CI Instances report displaying the CITs and relationships that were deleted.</p> <p>To access: Select Applications > Overview Reports > Delete Candidates Overview.</p> |
|---------------------------|--|

| | |
|------------------------------|---|
| Important Information | <ul style="list-style-type: none">▶ You must have Adobe Flash Player version 8.0 or later installed on your machine to view Overview reports. For details, see “Viewing Reports with Adobe Flash Player” in <i>Reference Information</i>.▶ For information about limitations on formatting reports, see “Formatting a Report” in <i>Reference Information</i>. |
| Useful Links | For details on how to work with reports, see “Working in Reports” in <i>Reference Information</i> . |

Generic Breakdown Report

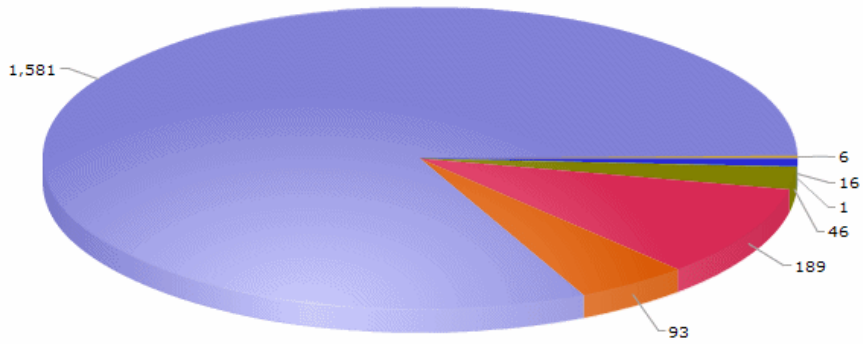

| Device | Windows | Host | Unix | Net Printer | Load Balancer |
|--------|---------|------|------|-------------|---------------|
| tch | | | | | |

| | |
|---------------------------|--|
| <p>Description</p> | <p>This report displays a pie chart showing the breakdown of CI types by:</p> <ul style="list-style-type: none"> ▶ The CITs grouped under the selected CI type in the CI type tree ▶ A CI type attribute <p>For details, see “CI Type Manager” on page 205.</p> <p>To view the breakdown by CI types:</p> <ol style="list-style-type: none"> 1 Select the required CI type in the Choose Initial CI Type box. 2 Select CI Type in the Break Down by box. <p>To view the breakdown by CI type attributes:</p> <ol style="list-style-type: none"> 1 Select the required CI type in the Choose Initial CI Type box. 2 Select the required CI type attribute in the Break Down by box. <p>Notes:</p> <ul style="list-style-type: none"> ▶ The Break down by box that is marked in blue is the current breakdown of the report. ▶ The current drilldown selection is marked below the breakdown’s filter. <p>You can display the number of each CI type or attribute by moving the cursor over the related color. The tooltip that appears displays the relevant number. To verify the CI types and attributes, use the legend below the pie chart.</p> <p>Click a pie segment to drill down to see a Show CI Instances report.</p> <p>Note: In the Show CI Instances report, click the link in the Display Label column to see the related CIs in a topology map.</p> <p>You can generate a report that has up to four different levels. If the pie chart has more than one level, use the links of the breadcrumbs at the top of the report to navigate through the various levels.</p> <p>To access: Select Applications > Overview Reports > Generic Breakdown.</p> |
|---------------------------|--|

| | |
|------------------------------|---|
| Important Information | <ul style="list-style-type: none">▶ You must have Adobe Flash Player version 8.0 or later installed on your machine to view Overview reports. For details, see “Viewing Reports with Adobe Flash Player” in <i>Reference Information</i>.▶ For information about limitations on formatting reports, see “Formatting a Report” in <i>Reference Information</i>. |
| Useful Links | For details on how to work with reports, see “Working in Reports” in <i>Reference Information</i> . |

Host OS Breakdown Report

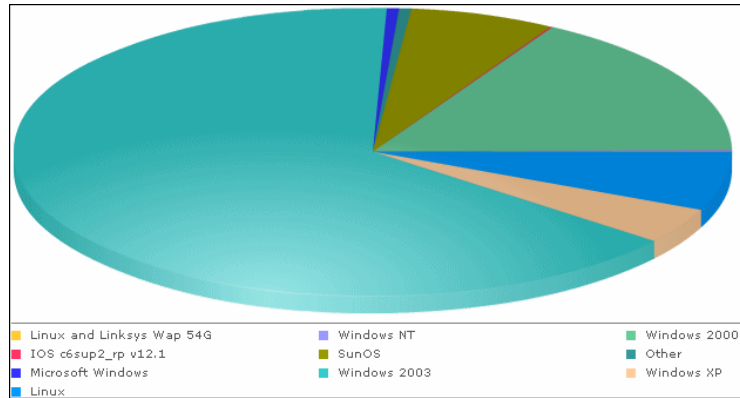

| | |
|-------------------------------------|--|
| <p>Description</p> | <p>This report displays a breakdown of operating systems. You can view all deployed operating systems or you can view data for operating systems at a certain location or running on a certain subnet.</p> <p>You can display the number of operating systems of each type by moving the cursor over the related color. The tooltip that appears displays the relevant number.</p> <p>Click a pie slice to drill down to see a Show CI Instances report for each operating system.</p> <p>To access: Select Applications > Overview Reports > Host OS Breakdown.</p> |
| <p>Important Information</p> | <ul style="list-style-type: none"> ▶ You must have Adobe Flash Player version 8.0 or later installed on your machine to view Overview reports. For details, see “Viewing Reports with Adobe Flash Player” in <i>Reference Information</i>. ▶ For information about limitations on formatting reports, see “Formatting a Report” in <i>Reference Information</i>. |
| <p>Useful Links</p> | <p>For details on how to work with reports, see “Working in Reports” in <i>Reference Information</i>.</p> |

Major Application Type Breakdown Report

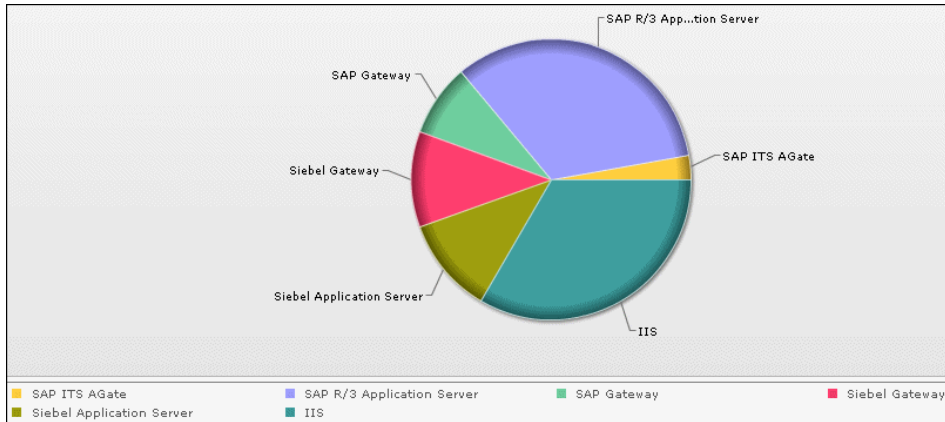

| Description | |
|-------------|--|
| | <p>This report displays a breakdown of major applications and their versions. Major applications are CITs that have been assigned the MAJOR_APP class qualifier. For details, see “Qualifiers Page” on page 230.</p> <p>You can view data for all applications deployed in the system, or only those at a specific location. Choose the country, state, and city for which you want to view application breakdown data, or select All to show the entire application breakdown.</p> <p>Use the legend below the pie chart to verify an application and the versions.</p> <p>Click a segment to view a specific application sorted by version.</p> <p>Click a pie segment to drill down to see a Show CI Instances report for each application version.</p> <p>To access: Select Applications > Overview Reports > Application Breakdown.</p> |

| | |
|------------------------------|---|
| Important Information | <ul style="list-style-type: none">▶ You must have Adobe Flash Player version 8.0 or later installed on your machine to view Overview reports. For details, see “Viewing Reports with Adobe Flash Player” in <i>Reference Information</i>.▶ For information about limitations on formatting reports, see “Formatting a Report” in <i>Reference Information</i>. |
| Useful Links | For details on how to work with reports, see “Working in Reports” in <i>Reference Information</i> . |

Network Device Breakdown Report

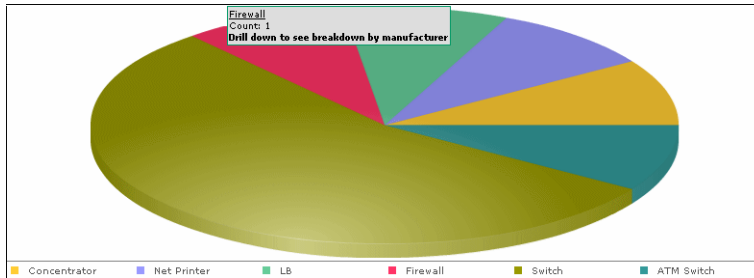

Description

Displays a breakdown of network devices. Only the network devices that meet the following conditions appear in the report:

- ▶ The CIT of the network device has been assigned the qualifier **NETWORK_DEVICES**. For details, see “Qualifiers Page” on page 230.
- ▶ The network device is connected to an **IP CI**.
- ▶ The network device is defined with the following attribute condition: **Host is complete = True**. For details, see “Attribute Tab” on page 377.

You can view all network devices deployed in the system or at a certain location. Choose the country, state, and city for which you want to view network device breakdown data, or select **All** to show the entire network device breakdown.

Each color in the pie chart represents a different network device. The legend underneath shows which network device each color represents. You can display the name and number of each network device by moving the cursor over the related color. The tooltip that appears displays the relevant information.

Click a segment to view a specific network device sorted by manufacturer.

Click a segment to generate a Show CI Instances report, displaying the details of the CI instances of that network device for that manufacturer.

To access: Select **Applications > Overview Reports > Network Device Breakdown**.

| | |
|------------------------------|---|
| Important Information | <ul style="list-style-type: none"> ▶ You must have Adobe Flash Player version 8.0 or later installed on your machine to view Overview reports. For details, see “Viewing Reports with Adobe Flash Player” in <i>Reference Information</i>. ▶ For information about limitations on formatting reports, see “Formatting a Report” on page 87 in <i>Reference Information</i>. |
| Useful Links | For details on how to work with reports, see “Working in Reports” in <i>Reference Information</i> . |

Number of Changes Report

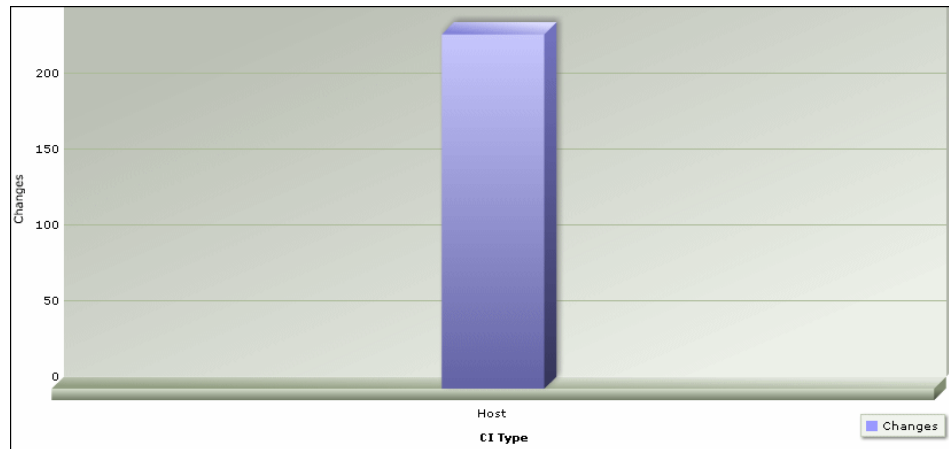

| | |
|--------------------|---|
| Description | <p>This report displays a bar graph showing the number of detected changes in a CIT within a defined period.</p> <p>Click the bar to view the breakdown of the types of changes that occurred for the CIT and its child CITs.</p> <p>To access: Select Applications > Overview Reports > Number of Changes.</p> |
|--------------------|---|

| | |
|-------------------------------------|--|
| <p>Important Information</p> | <ul style="list-style-type: none"> ▶ You must have Adobe Flash Player version 8.0 or later installed on your machine to view Overview reports. For details, see “Viewing Reports with Adobe Flash Player” in <i>Reference Information</i>. ▶ For information about limitations on formatting reports, see “Formatting a Report” in <i>Reference Information</i>. |
| <p>Useful Links</p> | <p>For details on how to work with reports, see “Working in Reports” in <i>Reference Information</i>.</p> |

Sample Change Type Breakdown Report

This example displays the breakdown of the types of changes that occurred for a CIT and its children.

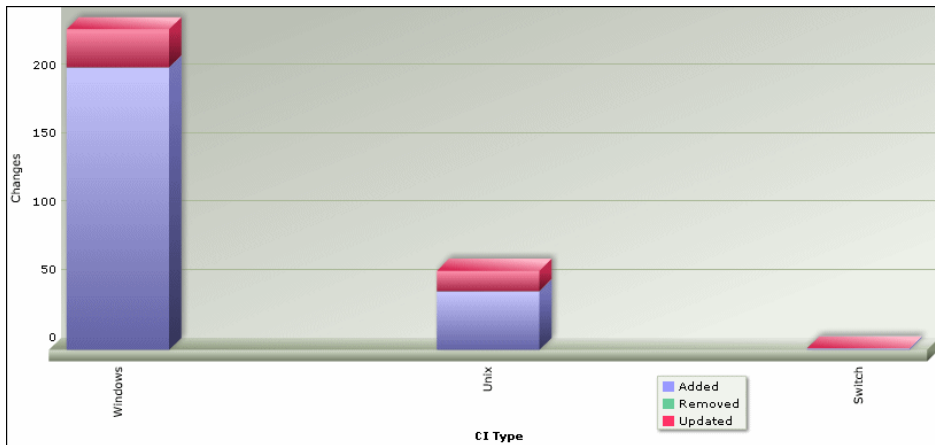

Each bar represents a different CI type. The CI type is displayed under the bar. Each color in the legend at the right of the bar graph represents a different type of change. You can display the number of each type of change by moving the cursor over the related color. The tooltip that appears displays the relevant number of changes that occurred.

Part IV

Users and Permissions

32

Users and Roles

This chapter provides information on Users and Roles.

This chapter includes:

Concepts

- ▶ Users and Roles Overview on page 639

Tasks

- ▶ Set Up Users on page 640

Reference

- ▶ Users and Roles User Interface on page 641

Troubleshooting and Limitations on page 648

Users and Roles Overview

When you create a user or role, you define which actions the user or role can perform. Roles enable you to assign permissions to users according to their responsibilities in the organization. For example, you could create a role that enables its users to create TQL queries, or you could create a role that enables its users to create views in View Manager but not to edit existing TQL queries.

You can assign administrator or guest access rights to these users or roles, and if necessary, specify additional permissions in the Security Manager, for example, which views a user can display. For details, see “Security Manager” on page 653.

Note: The Users and Roles pages are available only to those logged in with **admin** or **administrator** access rights.

Set Up Users

Use the following procedures to set up users in your system:

1 Define Roles

A role is a group of users to whom you assign the same access rights. For details, see “Users and Roles Overview” on page 639 and “Roles Tab” on page 645.

2 Assign Access Rights to the Roles

You assign permissions for roles to access HP Universal CMDB. For details, see “Set Up Security” on page 654 and “Security Manager Window” on page 656.

Note: From a best practices point of view, it is preferable to assign access rights to roles only, and to associate users with a role that has the appropriate access rights.

For details on assigning access rights to Web service users, see “Roles Tab” on page 645.

Example – Create a Role Hierarchy

One team maintains the Oracle databases in your organization and another maintains the Microsoft SQL Server databases. The team leader needs to be familiar with both databases. You can create a role hierarchy:

- a** Create two roles, `dba_oracle` and `dba_mssql`, and give the first role access rights to the Oracle view and the second role access rights to the SQL Server view. For details, see “Security Manager Window” on page 656 and “View Manager Window” on page 164.
- b** Create another role, `dba`, and give it rights to both the Oracle and SQL Server views.

3 Define Users

For details on defining a user, see “Users Tab” on page 646. When defining users, you associate a user with one or more roles. For details, see “Users and Roles Overview” on page 639.

4 Define a Profile for a User

You can set preferences, such as time zone and locale, for a specific user. For details, see “User Profile” on page 649.

Users and Roles User Interface

This section describes:

- Add New User Wizard on page 641
- New/Edit Role Dialog Box on page 644
- Roles Tab on page 645
- Users Tab on page 646

Add New User Wizard

| | |
|------------------------------|---|
| Description | Enables you to create a user. To access: Admin > Settings > Users and Roles > Users tab. Click the Add New User  button. |
| Important Information | It is recommended to define roles prior to defining new users. For details, see “Roles Tab” on page 645. |

| | |
|--------------------------|---|
| Included in Tasks | “Define Users” on page 641 |
| Wizard Map | The Add New User wizard contains: User Name and Password Page > User Details Page > Role List Page |

User Name and Password Page

| | |
|--------------------------|--|
| Description | Enables you to assign a name and password for the user. |
| Included in Tasks | “Define Users” on page 641 |
| Wizard Map | The Add New User Wizard contains: User Name and Password Page > User Details Page > Role List Page |

The following elements are included (unlabeled GUI elements are shown in angle brackets>):

| GUI Element (A-Z) | Description |
|--------------------------|---|
| Confirm Password | Type in the password you entered in the Password box. |
| Password | Type in a password. |
| User Name | Type a unique user name. |

User Details Page

| | |
|--------------------------|--|
| Description | Enables you to add the details of the user. |
| Included in Tasks | “Define Users” on page 641 |
| Wizard Map | The Add New User Wizard contains: User Name and Password Page > User Details Page > Role List Page |

The following elements are included (unlabeled GUI elements are shown in angle brackets):

| GUI Element (A-Z) | Description |
|-------------------------|--|
| Update recipient | Enables you to add the name and email address of the selected user to the Recipients Manager, or update the existing email address of a recipient currently listed in the Recipients Manager. For details, see “Recipients Manager” on page 507. |

Role List Page

| | |
|------------------------------|--|
| Description | Associate a user with one or more roles. |
| Included in Tasks | “Define Users” on page 641 |
| Important Information | If you do not select a role, you must assign permissions in the Security Manager to enable access rights for the user. For details, see “Security Manager Window” on page 656. |
| Useful Links | “Roles Tab” on page 645 |
| Wizard Map | The Add New User Wizard contains: User Name and Password Page > User Details Page > Role List Page |

The following elements are included (unlabeled GUI elements are shown in angle brackets):

| GUI Element (A-Z) | Description |
|-------------------|--|
| <List of roles> | Contains the list of default and custom roles. For details, see “Security Manager Window” on page 656. |

New/Edit Role Dialog Box

| | |
|--------------------------|--|
| Description | Enables administrators to create and manage roles, and assign permissions to each role to perform specific actions. For example, a role named <code>dba</code> could have permissions to view all database views and to create new views. To access: Click the New Role  or Edit button in the Roles tab. |
| Included in Tasks | “Set Up Users” on page 640 |



The following elements are included (unlabeled GUI elements are shown in angle brackets):

| GUI Element (A-Z) | Description |
|--------------------------|--|
| <Roles> | Contains the list of roles that appear in the Role list in the Roles tab. Select the roles whose permissions you want to assign to the new role. Note: If you do not select a role from the Role List, you must assign permissions in the Security Manager, to enable access rights for the role. For details, see “Security Manager Window” on page 656. |
| Description | Enter a description of the role you are defining. |
| Name | Enter a unique name for the role. |

Roles Tab

| | |
|--------------------------|--|
| Description | <p>Enables you to create, edit, and delete roles.</p> <p>For example, you can create a role that enables its users to create TQL queries, or you can create a role that enables its users to create views in the View Manager but not to edit existing TQL queries.</p> <p>To access: Admin > Settings > Users and Roles > Roles tab</p> |
| Included in Tasks | "Set Up Users" on page 640 |

The following elements are included (unlabeled GUI elements are shown in angle brackets>):







| GUI Element (A-Z) | Description |
|---|--|
|  | Click to add a new role. Opens the New Role dialog box. |
|  | Click to remove a selected role. You can make multiple selections. |
|  | Save the changes you have made. |

| GUI Element (A-Z) | Description |
|---|---|
|  | Click to edit an existing role. Opens the Edit Role dialog box. |
| <List of roles> | <p>Contains the list of default and custom roles.</p> <p>The default roles are:</p> <ul style="list-style-type: none"> ▶ Admin. Users with this role have unlimited access to all functions. ▶ Guests. Users with this role have permissions to display views in the Topology View. ▶ Web service roles. Users who are working with the HP Universal CMDB API or the Discovery and Dependency Mapping API to write data to the UCMDB must be given permissions to the UCMDB. <p>The following roles enable the API writer to work with the CMDB:</p> <ul style="list-style-type: none"> ▶ CmdbOpenApiClassModel. A user with this role can perform operations on CITs. ▶ CmdbOpenApiImpact. A user with this role can perform impact operations on the CMDB. ▶ CmdbOpenApiQuery. A user with this role can send queries to the CMDB and receive replies. ▶ CmdbOpenApiUpdate. A user with this role can update the CMDB with changes. <p>For details on writing APIs, see “The HP Universal CMDB Web Service API” in <i>Integrations</i>.</p> |

Users Tab

| | |
|---------------------|---|
| Description | <p>Enables you to define a user or edit an existing one.</p> <p>To access: Admin > Settings > Users and Roles > Users tab</p> |
| Useful Links | <ul style="list-style-type: none"> ▶ For details on the complete procedure for creating users and assigning roles and access permissions, see “Set Up Users” on page 640. ▶ For details on the Roles tab, see, “Roles Tab” on page 645. |

The following elements are included (unlabeled GUI elements are shown in angle brackets>):

| GUI Element (A-Z) | Description |
|---|--|
|  | Enables you to create a user. Opens the Add New User wizard. |
|  | Select a user and click to remove the user name. You can make multiple selections. |
|  | Save the changes you have made. |
|  | Refresh to update the data content that may have been modified by other users. |
|  | <p>Enables you to add the name and email address of the selected user to the Recipients Manager.</p> <p>You can make multiple selections. The button updates several recipients at one time. For details, see “Recipients Manager” on page 507.</p> |
| <List of users> | <p>Contains the list of default and custom users.</p> <ul style="list-style-type: none"> ▶  . Represents users that have Administrator access rights. ▶  . Represents users that do not have Administrator access rights. <p>The default users are:</p> <ul style="list-style-type: none"> ▶ Administrator. Users and roles with Administrator access rights have unrestricted access to all functions. Administrators can edit the access rights of the default users and roles. ▶ admin. Users and roles with admin access rights have the same access rights as Administrators. ▶ guest. Users and roles with guest access rights have permissions to display views in the Topology View. |
| Details tab | Edit the user details as required. For details, see “User Details Page” on page 642. |
| Full Name | The first and last name of the user as defined in the Details tab. For details, see “User Details Page” on page 642. |

| GUI Element (A-Z) | Description |
|--------------------|---|
| Roles tab | Associate a user with different roles. For details, see “Role List Page” on page 643. |
| Profile tab | Edit the preferences, such as time zone and locale, for a specific user. For details, see “User Profile” on page 649. |
| User Name | The name of the user. |

Troubleshooting and Limitations

You cannot create a new user if the name of the new user contains more than 16 Japanese characters. For details, see “Users Tab” on page 646.

33

User Profile

This chapter provides information on User Profile.

This chapter includes:

Concepts

- ▶ User Profile Overview on page 649

Tasks

- ▶ Define User Preferences on page 650

Concepts

- ▶ User Profile User Interface on page 650

User Profile Overview

You can configure the preferences of the currently logged in user, such as the time zone, or the editor to use when editing configuration files. For details, see “User Profile Dialog Box” on page 650.

Note: Administrators can configure profiles for all users using the Users page in Users and Roles. For details, see the “Users Tab” on page 646.

Define User Preferences

Configure preferences for the currently logged in user. For details, see “User Profile Dialog Box” on page 650.

User Profile User Interface



This section describes:

- ▶ User Profile Dialog Box on page 650

User Profile Dialog Box

| | |
|------------------------------|---|
| Description | Enables you to set preferences for the currently logged in user. To access: <ul style="list-style-type: none">▶ For admin users: Select a user and click the Profile button in the Users page in Users and Roles. For details, see “Users Tab” on page 646.▶ For non-admin users: Admin > Settings > User Profile. |
| Important Information | Non-admin users can change their own password here. |
| Included in Tasks | “Define User Preferences” on page 650 |

The following elements are included (unlabeled GUI elements are shown in angle brackets>):

| GUI Element (A-Z) | Description |
|---|--|
| Change Password | Click to open the Change Password dialog box. Enter the old and new passwords and click OK . |
| Label Transparency | <ul style="list-style-type: none"> ▶ Yes. If you drag one CI on top of another CI so that the text of one label overlaps the text of the other label, the text of both labels remains visible. ▶ No. The default. If you drag one CI on top of another CI so that the text of one label overlaps the text of the other label, the text of only one of the labels remains visible. |
| Max number of characters in a line | Enter the maximum size (in characters) of item labels. In the following example, a maximum number of 15 characters is defined: <div data-bbox="582 739 753 821" style="border: 1px solid black; padding: 5px; margin: 10px 0;">  labm2am172.dev1 </div> |
| Max number of lines | Enter the maximum number of lines for an item label. When the label is longer than the number of allocated characters, text flows to the next line. In the following example, a maximum number of 10 characters and three lines is defined: <div data-bbox="582 1025 719 1199" style="border: 1px solid black; padding: 5px; margin: 10px 0;">  labm1platt orm07.dev1 ab.ad </div> |
| Time zone | Select the appropriate time zone, according to the user's location. |

34

Security Manager

This chapter provides information on Security Manager.

This chapter includes:

Concepts

- ▶ Security Manager Overview on page 653

Tasks

- ▶ Set Up Security on page 654
- ▶ Assign Access Rights on page 654

Reference

- ▶ Security Manager User Interface on page 654

Security Manager Overview

You assign role access rights to TQL queries, views, domain instances, configuration item types, and customize options. Once the roles are assigned access rights, you create users and associate them with a role or roles, thus assigning the access rights to the users.

You must also assign access rights to the appropriate manager (Correlation Manager, CI Type Manager, Query Manager, and so on). For example, to give a role permissions for a view, give the role access rights to the View Manager.

When users launch HP Universal CMDB, the actions for which you gave them permissions are available. For example, if a user is not assigned permissions to create a new role, the Users and Roles option in the Settings tab is not available. If a user is not assigned permissions to view a certain manager, the manager does not appear in HP Universal CMDB.

Set Up Security

Choose the roles (recommended) or users for which you are assigning permissions. For details, see “Role and User Selector Dialog Box” on page 655.

Assign Access Rights

Enable permissions for a resource. For details, see “Security Manager Window” on page 656.

Security Manager User Interface







This section describes:

- ▶ Role and User Selector Dialog Box on page 655
- ▶ Security Manager Window on page 656

Role and User Selector Dialog Box

| | |
|------------------------------|---|
| Description | Enables you to choose the roles or users for which you are assigning access rights. To access: Click the Add button  in the Roles/Users pane. |
| Important Information | The roles and users that appear are defined in Users and Roles. For details, see “Users and Roles” on page 639. |
| Included in Tasks | “Set Up Security” on page 654 |

The following elements are included (unlabeled GUI elements are shown in angle brackets>):

| GUI Element (A-Z) | Description |
|--|--|
|  | Move the role or user to the Selected Roles and Users pane. |
|  | Move the role or user back to the Defined Roles and Users pane. |
|  | Move all the roles and user to the Selected Roles and Users pane. |
|  | Move all the roles and users back to the Defined Roles and Users pane. |
| Defined Roles and Users pane | Contains the list of the roles and users that are defined in Users and Roles. |
| Description | A description of the role or user. |
| Name | The name of the role or user. |
| Selected Roles and Users pane | The roles or users for which you are assigning permissions for the selected resource. |
| Type |  Represents a user.  Represents a role. |

Security Manager Window

| | |
|------------------------------|---|
| Description | Enables you to assign access rights to view, create, update, remove, or perform actions. To access: Select Admin > Settings > Security Manager . |
| Important Information | <ul style="list-style-type: none"> ▶ When assigning permissions, you must also assign access rights to the appropriate manager. For example, to give a role permissions for a view, give the role access rights to the View Manager. ▶ Do not give regular users access to the Admin > Settings > Users and Roles menu option. This is because an administrator can override any user's password from this menu option. Users can change their own passwords through the Change Password option. For details, see "User Profile" on page 649. ▶ It is recommended to assign access rights to roles only, and to associate users with a role that has the appropriate access rights. ▶ You cannot select an item at the folder level. ▶ If you make a selection at the root level, the user or role receives access rights to all items contained in the root. ▶ Child resources inherit the permissions assigned to their parents or the nearest ancestor to which permissions are assigned. For example, if you assign permissions to Host, its children (ATM Switch, Concentrator, and so on) inherit the permissions assigned to Host. |
| Included in Tasks | "Assign Access Rights" on page 654 |

The following elements are included (unlabeled GUI elements are shown in angle brackets>):

| GUI Element (A-Z) | Description |
|---------------------|---|
| CI Types tab | Give permissions to users to perform a specific operation on the selected CI types. |

| GUI Element (A-Z) | Description |
|----------------------|---|
| Customize tab | <p data-bbox="621 222 1213 314">Give permissions to users to view, update, or perform specific operations in the UCMDB Admin and Application menus.</p> <p data-bbox="621 331 778 357">CMDB Admin</p> <ul style="list-style-type: none"> <li data-bbox="621 374 1235 435">▶ Modeling. Grants permissions to access the UCMDB Managers. <li data-bbox="621 444 768 470">▶ Discovery: <ul style="list-style-type: none"> <li data-bbox="649 479 1263 609">▶ View. View the configuration of the DDM jobs in the Run Discovery tab, for example, which DDM job is active, and information and statistics about all active jobs and errors discovered during a run. <li data-bbox="649 618 1249 739">▶ Update. (Requires Execute permissions) Grants full permissions for all DDM operations, including updating and creating new DDM patterns, scripts, and configuration files. <li data-bbox="649 748 1249 878">▶ Execute. (Requires Execute permissions) Grants permissions to activate DDM jobs, run the DDM wizards, define a schedule for a DDM job, override DDM pattern behavior, and edit DDM TQLs. <li data-bbox="621 887 1178 947">▶ Settings: Grants permissions to users to view or perform operations in the selected application. <p data-bbox="621 965 749 991">Application</p> <p data-bbox="621 1008 1263 1164">Grants permissions to users to access Topology View Application and CI Lifecycle, to compare CIs, compare snapshots, to generate a Gold Master report, to generate Host Dependency, Change, System, and Asset reports, and to generate Overview reports.</p> <p data-bbox="621 1182 806 1208">General Actions</p> <ul style="list-style-type: none"> <li data-bbox="621 1225 1249 1286">▶ Search CIs Permission. Grants permissions to users to access the CI Selector search option. <li data-bbox="621 1295 1206 1355">▶ Get Related CIs Permission. Grants permissions to users to view data of related CIs. <li data-bbox="621 1364 1263 1425">▶ Data Modifier Permission. Grants permissions to users to change CIs in IT Universe Manager. |

| GUI Element (A-Z) | Description |
|-------------------|--|
| Domain tab | Give permissions to users to edit the DDM domain credentials and the range of network addresses for the DDM probe. |
| TQLs tab | Give permissions to users to view, update, or delete the selected TQLs. |
| Views tab | Give permissions to users to view, update, or delete the selected views. |

Resources Pane

| | |
|--------------------|--|
| Description | Contains the resource tree for the selected tab. |
|--------------------|--|



The following elements are included (unlabeled GUI elements are shown in angle brackets>):

| GUI Element (A-Z) | Description |
|----------------------------------|--|
| <Resources for the selected tab> | Select the resource to which you want to assign access rights. |

Roles/Users Pane

| | |
|--------------------|---|
| Description | Displays the users or roles for which you want to assign permissions for the selected resource. |
|--------------------|---|

The following elements are included (unlabeled GUI elements are shown in angle brackets>):

| GUI Element (A-Z) | Description |
|---|--|
|  | Choose users or roles to which you want to assign permissions for the selected resource. |
|  | Remove the selected user or role for the selected resource. |
|  | Remove all the users and roles for the selected resource. |

Permissions Pane

| | |
|--------------------|---|
| Description | Enables you to apply permissions to roles and users for specific resources and instances of those resources that are defined in the system. |
|--------------------|---|

The following elements are included (unlabeled GUI elements are shown in angle brackets>):

| GUI Element (A-Z) | Description |
|--------------------------|--|
| Permissions | <p>To enable permissions for a resource, you must first select the role or user to which you are assigning access rights. Then select the check box next the action that you want the user or role to perform.</p> <ul style="list-style-type: none"> ▶ View. The role or user can view the resource, but cannot make changes. ▶ Create. The role or user can define new resources. ▶ Update. The role or user can update an existing resource. ▶ Remove. The role or user can delete a resource from the CMDB. ▶ Execute. The role or user can perform actions, for example, running a script. <p>Note: Only those permissions that are relevant to the selected resource are enabled.</p> |

35

LDAP Manager

This chapter provides information on LDAP Manager.

This chapter includes:

Concepts

- ▶ LDAP Manager Overview on page 661

Tasks

- ▶ Synchronize User Groups With LDAP on page 662

Reference

- ▶ LDAP Manager User Interface on page 664

LDAP Manager Overview

The LDAP server can be used as a user repository for mapping user groups on the LDAP server to user groups in HP Universal CMDB. You can perform updates to users and groups in HP Universal CMDB via the LDAP server.

Synchronizing groups is done via the LDAP Manager in the Settings tab. The LDAP Manager only appears in the Settings tab if:

- ▶ The LDAP setting in HP Universal CMDB Infrastructure settings is configured to **Enabled**. For details, see “Infrastructure Settings Manager – Overview” on page 453.
- ▶ The user has the required permissions. For details, see “Users and Roles Overview” on page 639.

For details on synchronizing LDAP groups with HP Universal CMDB groups, see “Synchronize User Groups With LDAP” on page 662.

Synchronize User Groups With LDAP

This task describes how to synchronize LDAP user groups with HP Universal CMDB user groups:

This task includes the following steps:

- “Configure Infrastructure Settings to Set an LDAP Synchronization Strategy” on page 662
- “Create HP Universal CMDB Groups” on page 663
- “Map LDAP Groups to HP Universal CMDB Groups” on page 663

1 Configure Infrastructure Settings to Set an LDAP Synchronization Strategy

To set up an LDAP authentication synchronization, you must first modify the settings in the Infrastructure Settings Manager. Any changes you make remain in effect for all future Web sessions.

- a** Select **Admin > Settings > Infrastructure Settings Manager** and select **Foundations > LDAP Configuration**.
- b** In the **LDAP server URL** setting, enter the url of the LDAP server in the following format:
`ldap://<ldapHost>[:<port>]/[<baseDN>][??scope`
- c** In the **Remote users repository mode** setting, select **Enabled**.
- d** In the **Groups base DN setting**, enter the distinguished name of the general group.
- e** In the **Root groups base DN setting**, enter the distinguished name of the root group.
- f** Locate the **Enable User Synchronization** setting and verify that the value is set to **True**.

- g** Log out of UCMDB and log in again. LDAP Manager appears under the **Settings** tab.

For details on Infrastructure Settings Manager, see “Infrastructure Settings Manager – Overview” on page 453.

2 Create HP Universal CMDB Groups

You can create local HP Universal CMDB groups that can be assigned to the remote LDAP server.

3 Map LDAP Groups to HP Universal CMDB Groups

You map user groups on the LDAP server with groups in HP Universal CMDB to synchronization LDAP groups and HP Universal CMDB groups and enable management of your HP Universal CMDB groups via the LDAP server, as follows:

- a** Select **Admin > Settings > LDAP Manager**.
- b** In the **Corporate Directory Remote Repository** pane, select a remote group and click **Assign Groups**.

The HP Universal CMDB groups synchronized with the selected LDAP group are displayed in the **Corporate Directory Local Repository for Remote Group: <group name>** pane.

Existing synchronization of all LDAP groups is displayed in the **Local Groups to Remote Group Mapping** pane.

Important: When defining mappings, make sure to map at least one LDAP group to an Admin group in the CMDB before logging out. If this is not done, you may not have any remaining group with administration permissions.

LDAP Manager User Interface

This section describes:

- ▶ LDAP Manager on page 664

LDAP Manager

| | |
|------------------------------|---|
| Description | Enables you to map groups configured in HP Universal CMDB to groups configured on the LDAP server. To access: Select Admin > Settings > LDAP Manager . |
| Important Information | The LDAP Manager consists of the following panes: <ul style="list-style-type: none"> ▶ Corporate Directory Remote Repository Pane. For details, see “Corporate Directory Remote Repository Pane” on page 664. ▶ Corporate Directory Local Repository for Remote Group: <group name> Pane. For details, see “Corporate Directory Local Repository for Remote Group: <group name> Pane” on page 665. ▶ Local Groups to Remote Group Mappings. Displays a table of the LDAP groups and the HP Universal CMDB groups to which they are assigned. The LDAP groups are displayed in the Remote Group Name column, and the HP Universal CMDB Groups are listed in the Local Group Name column. |

Corporate Directory Remote Repository Pane

| | |
|------------------------------|--|
| Description | Enables you to assign HP Universal CMDB groups to LDAP groups, and to list the users in the LDAP groups. |
| Important Information | <ul style="list-style-type: none"> ▶ To synchronize LDAP groups with HP Universal CMDB groups, click Assign Groups to open the Select Local Groups for Remote Group dialog box. ▶ To view the list of users associated with the respective LDAP groups, click List Users. <p>You can also select either of these options by right clicking on the group.</p> |

**Corporate Directory Local Repository for Remote Group:
<group name> Pane**

| | |
|------------------------------|---|
| Description | Displays the HP Universal CMDB mapped to the LDAP group selected in the Corporate Directory Pane, and enables you to remove the mapped HP Universal CMDB groups. |
| Important Information | <ul style="list-style-type: none">▶ To remove groups, select the group you want to remove and click Remove Groups.▶ You can remove multiple groups at once by holding the CTRL button while selecting groups. |

Part V

View Explorer

36

Working with View Explorer

This chapter provides information on View Explorer.

Note: In IT Universe Manager, the Topology View Application, and the Modeling Studio, View Explorer is called CI Selector.

This chapter includes:

Concepts

- ▶ View Explorer Overview on page 670

Tasks

- ▶ Display a View in Browse Mode on page 670
- ▶ Search for CIs in Search Mode on page 671
- ▶ Modify View Explorer Display Options on page 674

Reference

- ▶ View Explorer User Interface on page 675

Troubleshooting and Limitations on page 685

View Explorer Overview

View Explorer presents the elements of the IT universe model in HP Universal CMDB through the medium of views. HP Universal CMDB displays View Explorer in the left pane of IT Universe Manager.

When you select a view in View Explorer, the configuration items (CIs) contained in the view are displayed in a hierarchical tree format according to the relationships defined between the CIs. A view may be empty if no CIs were found matching the TQL query. For details on views, see “View Formats” on page 130.

You can use View Explorer to select views and to locate CIs. You can select a view and browse through the list of CIs, or you can search for a CI if you do not know in which view the CI is included.

For information on the components of View Explorer, see “View Explorer User Interface” on page 675.

Display a View in Browse Mode

When View Explorer is set to **Browse** mode, you can display the contents of a selected view. For details on the View Explorer user interface in Browse mode, see “Browse Mode” on page 677.

This task includes the following steps:

- “Prerequisites” on page 670
- “Select a View to Display” on page 671

1 Prerequisites

In the View Explorer pane, select **Browse** mode. (In IT Universe Manager or Topology View, select **View Browser**.)

2 Select a View to Display



Click the ellipsis button to open the Select view dialog box and select the view you want to display. The name of the selected view is shown in the **View** box. The CIs in the view appear in the CI tree in the lower part of the View Explorer pane. The view remains selected when you move to other applications in HP Universal CMDB.

Search for CIs in Search Mode

The View Explorer search tool enables you to find the CI you need, so that you can shift the focus, in the application in which you are working, to that CI. You can set up searches based on any combination of the filter criteria described in the task. For details on the View Explorer search tool user interface, see “Search Mode” on page 681.

This task includes the following steps:

- “Prerequisites” on page 671
- “Search by CI Name” on page 671
- “Filter the Scope of the Search” on page 672
- “Search by Related Configuration Item” on page 672
- “Search by Configuration Item Type” on page 673
- “Run the Search and Sort the Results” on page 673

1 Prerequisites

In the View Explorer pane, select **Search** mode. (In IT Universe Manager or Topology View, select **CMDB Search**.)

2 Search by CI Name

To search for CIs by name, enter a string in the **Search for** box, representing the name of the CI, or part of the name. The search returns all CIs that contain the entered string somewhere in the name (within the boundaries of the other search criteria that you define).

When using this search option, note the following:

- ▶ The search by CI name option is not case sensitive.
- ▶ You can use the wildcard character asterisk (*) as follows:
 - ▶ If you enter `serv`, all CIs containing the string `serv` are returned.
 - ▶ If you enter `serv*`, only CIs with names beginning with `serv` are returned.

Note: The wildcard character asterisk is not relevant in search mode in IT Universe Manager or Topology View.

3 Filter the Scope of the Search

All searches in View Explorer must specify the locations in which to search (this option is not available in IT Universe Manager):

- ▶ **The current view only.** This option includes the view currently selected in Browse mode.
- ▶ **All views.** This option searches in the most recently accessed views. It does not include any views that are unavailable in the current application. For information on unavailable views, see “Unavailable Views and CIs” on page 685.
- ▶ **The entire CMDB.** This option enables you to find CIs that are not included in any view, or that are part of a view that is unavailable in IT Universe Manager. This option is only available if you are working in Change Report.

Note: In IT Universe Manager, the search is always run on the entire CMDB.

4 Search by Related Configuration Item

You can search for CIs using the **Related to** box (this option is not available in IT Universe Manager or Topology View). This search returns CIs that have defined relationships to the CI specified in the **Related to** box.

 Click the ellipsis button to open the Select Configuration Item dialog box and select the required CI. You cannot manually enter a CI in the **Related to** box.

Note: The results list includes only those relationships that exist in the CMDB and are included in a view.

After defining a CI in the **Related to** box, HP Universal CMDB remembers your selection until you move to a different application, or until you define a different value. The selection is shown as inactive; you activate it again for a search by selecting the check box.

5 Search by Configuration Item Type

You can search for CIs using the **CI type** box. This search returns CIs that are of the type specified in the **CI type** box.

 Click the ellipsis button to open the Select Configuration Item Type dialog box and select the required CI type. You cannot manually enter a CIT in the **CI type** box.

After defining a CI in the **CI type** box, HP Universal CMDB remembers your selection until you move to a different application, or until you define a different value.

6 Run the Search and Sort the Results

Run the search. The results are listed in the lower part of the View Explorer pane, showing the CI name and the name of the view that the CI appears in, for each entry. In IT Universe Manager and Topology View, the results display the CI name and the CI type. You can sort the search results by clicking the appropriate heading.

Modify View Explorer Display Options

You can modify the display options for View Explorer. These options are configured in the Infrastructure Settings Manager.

Important: Modifying certain settings in the Infrastructure Settings Manager can adversely affect the performance of HP Universal CMDB. Do not modify settings without first consulting HP Software Support or your HP Professional Services representative.

This task includes the following steps:

- “Prerequisites” on page 674
- “Modify Selected Settings” on page 674

1 Prerequisites

Access the Infrastructure Settings Manager by selecting **Admin > Settings > Infrastructure Settings Manager**. Select the **Foundations** context and choose **View Explorer** from the list.

2 Modify Selected Settings

The following settings can be modified:

- **Immediate Children Count.** Number of children immediately displayed when expanding their parent’s node in View Explorer.
- **Maximal Children Count.** Maximum number of children displayed under their parent’s node in View Explorer.
- **Maximal search results size.** Maximum number of CMDB instances that can be returned in one search operation.
- **Recently Used Views List size.** Maximal number of recently used views to store per user.

Note: Some of the settings are not relevant in IT Universe Manager and Topology View.

View Explorer User Interface

This section describes:

- CI Instances Dialog Box on page 675
- View Explorer on page 676

CI Instances Dialog Box

| | |
|------------------------------|---|
| Description | Enables you to view the CIs in your search results in a separate window. To access: In the CI Selector in IT Universe Manager, in CMDB Search mode, click Show CIs in table . |
| Important Information | The CI Instances dialog box displays the results of your CMDB search in tabular form. You can select the columns you want to appear in the table. The functionality of the CI Instances dialog box is the same as that for the Element Instances dialog box, which is available in the other managers. For details, see “Element Instances Dialog Box” on page 368. |













View Explorer





| | |
|------------------------------|---|
| Description | <p>Enables you to select views and to locate CIs.</p> <p>To access: Appears in the left pane of the IT Universe Manager window, Topology View, and Modeling Studio.</p> |
| Important Information | <p>View Explorer consists of two functional formats: Browse mode and Search mode.</p> <ul style="list-style-type: none"> ▶ In Browse mode you can search for and display a view, and browse through the view to locate a particular CI. You can also perform operations for the CI from a context menu. In IT Universe Manager, you access this mode by selecting View Browser from the drop-down window. ▶ In Search mode you can search for one or more CIs in the views or the CMDB, search for all occurrences of a CI, or filter the list of CIs that is displayed. In IT Universe Manager, you access this mode by selecting CMDB Search from the drop-down window. |
| Included in Tasks | <p>“Display a View in Browse Mode” on page 670</p> <p>“Search for CIs in Search Mode” on page 671</p> |



Browse Mode

The following elements are included (unlabeled GUI elements are shown in angle brackets>):

| GUI Element (A-Z) | Description |
|--|--|
|   | <p>Click to refresh the CI tree of the view.</p> <p>In IT Universe Manager and Topology View, the following options are available:</p> <ul style="list-style-type: none"> ▶ Refresh the data content of the hierarchical tree structure that may have been modified by other users. ▶ Rebuild the view by performing a full recalculation. <p>Note: The recalculation may take a long time.</p> |
|  | <p>Click Add selected CIs to model/view to add the selected CIs to the current model or view.</p> <p>Note: This button only appears in the Modeling Studio.</p> |
|  | <p>Click Add as related CI to add the selected CI to the model as a related CI.</p> <p>Note: This button is only active in the Model Editor of the Modeling Studio.</p> |
|  | <p>Click Open selected model in a new tab to open the selected model in the Model Editor.</p> <p>Note: This button is only active when a model is selected in the Modeling Studio.</p> |
|  | <p>Click Generate view for selected model to open the Creating New View dialog box which enables you to build a view based on the selected model.</p> <p>Note: This button is only active when a model is selected in the Modeling Studio.</p> |
|  | <p>Click Show View Definition to go directly to View Manager or the Modeling Studio for the current view.</p> <p>Note: This button only appears in IT Universe Manager.</p> |





| GUI Element (A-Z) | Description |
|---|--|
|  | <p>Click Show Discovery and Changes Summary to rediscover all the CIs in a selected view by manually starting the DDM jobs that originally discovered them. For details, see “Discovery and Changes Summary Dialog Box” on page 59.</p> <p>Note: This button only appears in IT Universe Manager.</p> |
|  | <p>Click Generate Direct Link to View to create a direct link to the view using the Direct Links wizard.</p> <p>Note: This button only appears in IT Universe Manager and Topology View.</p> |
|  | <p>Choose the export format for the table data. The available options are:</p> <ul style="list-style-type: none"> ▶ Excel. The table data is formatted as an .xls (Excel) file that can be displayed in a spreadsheet. ▶ PDF. The table data is exported in PDF format. ▶ RTF. The table data is exported in Rich Text Format. ▶ CSV. The table data is formatted as a comma-separated values (CSV) text file that can be displayed in a spreadsheet. <p>Note: For the CSV formatted table data to display correctly, the comma (,) must be defined as the list separator. In Windows, to verify or modify the list separator value, open Regional Options from the Control Panel, and on the Numbers tab ensure that the comma is defined as the List Separator value. In Solaris, you can specify the list separator in the application that opens the CSV file.</p> <ul style="list-style-type: none"> ▶ XML. The table data is formatted as an XML file that can be opened in a text or XML editor. <p>Tip: To extract HTML code from the report:</p> <ul style="list-style-type: none"> ▶ Save the file as HTML ▶ Open the file in an HTML editor ▶ Copy the relevant table into the target file |



| GUI Element (A-Z) | Description |
|---|--|
|  | <p>Opens the Save Snapshot dialog box, which enables you to save a snapshot of the view. For details, see “Save Snapshot Dialog Box” on page 531.</p> <p>Note: This button only appears in IT Universe Manager and Topology View.</p> |
|  | <p>Click Asset Report to open the Asset report for the selected view. For details, see “Asset Report Overview” on page 577.</p> <p>Note: This button only appears in IT Universe Manager and Topology View.</p> |
|  | <p>In IT Universe Manager and Topology View, this icon represents the Set View Parameters button. The Set View Parameters button is only active if at least one node in the selected view has a parameterized node condition. Displays the Set View Parameters dialog box where you can edit the parameter of each condition. For details, see “Set View Parameters/Set View Element Parameters Dialog Box” on page 163.</p> <p>In the Modeling Studio, this icon represents Open Selected View in Editor area. Click Open Selected View in Editor area to open the current view in a separate tab in the View Editor.</p> |
|  | <p>Click the Menu option button to display a context-sensitive menu containing the options you can perform on a selected CI. You can also display the menu by right-clicking a CI.</p> <p>Note: This button does not appear in IT Universe Manager, Topology View, or the Modeling Studio.</p> |
|  | <p>Click the Close/Open button to hide or display the View Explorer pane.</p> <p>Note: This button does not appear in IT Universe Manager, Topology View, or the Modeling Studio.</p> |

| GUI Element (A-Z) | Description |
|---|--|
|  | <p>Click the Select view from the folder tree button to the right of the View box, to open the Select View dialog box. You can browse through the folder tree to locate the view you want to display.</p> |
|  | <p>Enables you to move to the next or previous result of the search for the string entered in the Find</p> <p>Note: This feature only appears in IT Universe Manager, Topology View, and the Modeling Studio.</p> |
| <CIs> | <p>The CIs contained in the currently selected view.</p> |
| <Tooltip> | <p>Hold the cursor over a CI to display a tooltip with the relevant CI type.</p> |
| Find | <p>Enter a CI name or a portion of a CI name in the Find box to locate a CI in the CI tree. The search only works for layers that have previously been expanded. CIs in sublayers that have not been expanded in the tree are not included in the search.</p> <p>Note: This feature only appears in IT Universe Manager, Topology View, and the Modeling Studio.</p> |
| View | <p>The View box displays the currently selected view. To select a view to display, click the down arrow on the right side of the View box; this displays an abridged list of views, containing the most recently accessed views. Click the arrow at the bottom of the list to scroll through the entire list. (In IT Universe Manager, the recently accessed views appear at the top of the drop-down, above the dividing line. The complete list of views appears below the line.)</p> <p>Alternatively, place the cursor in the list and begin typing the view name. HP Universal CMDB completes the view name, if the first few letters that you type match an existing entry. If the names of several views begin with those letters, all matching views are displayed in the list.</p> |

Search Mode

The following elements are included (unlabeled GUI elements are shown in angle brackets>):

| GUI Element (A-Z) | Description |
|--|--|
|  | <p>Click Show CIs in Table to open a separate window with a table of the CIs in the search results.</p> <p>Note: This button only appears in IT Universe Manager and Topology View.</p> |
|  | <p>Click Add selected CIs to model/view to add the selected CIs to the current model or view.</p> <p>Note: This button only appears in the Modeling Studio.</p> |
|  | <p>Click Add as related CI to add the selected CI to the model as a related CI.</p> <p>Note: This button is only active in the Model Editor of the Modeling Studio.</p> |
|  | <p>Click Open selected model in a new tab to open the selected model in the Model Editor.</p> <p>Note: This button is only active when a model is selected in the Modeling Studio.</p> |
|  | <p>Click Generate View for Selected Model to open the Creating New View dialog box which enables you to build a view based on the selected model.</p> <p>Note: This button is only active when a model is selected in the Modeling Studio.</p> |

| GUI Element (A-Z) | Description |
|---|--|
|  | <p>Choose the export format for the table data. The available options are:</p> <ul style="list-style-type: none"> ▶ Excel. The table data is formatted as an .xls (Excel) file that can be displayed in a spreadsheet. ▶ PDF. The table data is exported in PDF format. ▶ RTF. The table data is exported in Rich Text Format. ▶ CSV. The table data is formatted as a comma-separated values (CSV) text file that can be displayed in a spreadsheet. <p>Note: For the CSV formatted table data to display correctly, the comma (,) must be defined as the list separator. In Windows, to verify or modify the list separator value, open Regional Options from the Control Panel, and on the Numbers tab ensure that the comma is defined as the List Separator value. In Solaris, you can specify the list separator in the application that opens the CSV file.</p> <ul style="list-style-type: none"> ▶ XML. The table data is formatted as an XML file that can be opened in a text or XML editor. <p>Tip: To extract HTML code from the report:</p> <ul style="list-style-type: none"> ▶ Save the file as HTML ▶ Open the file in an HTML editor ▶ Copy the relevant table into the target file |
|  | <p>In the Related to window, click to open the Select Configuration Item dialog box, where you select the required CI.</p> <p>In the CI type window, click to open the Select Configuration Item Type dialog box, where you select the required CIT to search for.</p> <p>Note: This is not relevant in IT Universe Manager, Topology View, or the Modeling Studio.</p> |
|  | <p>Enables you to move to the next or previous result of the search for the string entered in the Find field.</p> <p>Note: This feature only appears in IT Universe Manager, Topology View, and the Modeling Studio.</p> |

| GUI Element (A-Z) | Description |
|-------------------|--|
| <Search results> | <p>After you run the search, the results are listed in the lower part of the View Explorer pane. The results are shown in two columns:</p> <ul style="list-style-type: none"> ▶ Name. Contains the name of the CI. ▶ View. Contains the name of the view in which the CI appears. <p>(In IT Universe Manager, the search results columns shown are Name and CI Type.)</p> <p>If the CI or view name is abbreviated, hold the pointer over the entry to see the full name. You can sort the search results by clicking the appropriate heading.</p> |
| CI type | <p>To search for CIs related to a specified CI type, click the ellipsis button to select a CI from the Select Configuration Item Type dialog box and select the CI Type check box (the check box is not relevant in IT Universe Manager).</p> <p>In IT Universe Manager, you can search incrementally by typing the first few letters of the required CI type.</p> |
| Find | <p>Enter a CI name or a portion of a CI name in the Find box to locate a CI in the search results.</p> <p>Note: This feature only appears in IT Universe Manager, Topology View, and the Modeling Studio.</p> |
| Name filter box | <p>Enter a CI name or part of a name in the filter box under the Name column of the results and press Enter to filter the results by name.</p> <p>Note: This is not relevant in IT Universe Manager, Topology View, or the Modeling Studio.</p> |
| Related to | <p>To search for CIs of a specified CI, select the Related to check box and click the ellipsis button to select a CI from the Select Configuration Item dialog box.</p> <p>Note: This is not relevant in IT Universe Manager, Topology View, or the Modeling Studio.</p> |

| GUI Element (A-Z) | Description |
|--|---|
| Search  | Click to run the search. The search results are displayed in the lower part of the View Explorer pane. |
| Search for | In the Search for box, enter the name of the CI (or part of the name). For more information, see “Filter the Scope of the Search” on page 672. |
| Search in | Specify the scope of your search. You can limit your search to the current view, search in the most recently accessed views (by selecting All views), or search the entire CMDB. The default option is Current view . Select the required option. For more information, see “Filter the Scope of the Search” on page 672. Note: This is not relevant in IT Universe Manager, Topology View, or the Modeling Studio. |
| Search results count | The Search results count below the Find box displays the total number of CIs found in the search. Note: This feature only appears in IT Universe Manager, Topology View, and the Modeling Studio. |
| View filter box | Enter a view name or part of a name in the filter box under the View column of the results and press Enter to filter the results by view. Note: This is not relevant in IT Universe Manager, Topology View, or the Modeling Studio. |

Context Menu Options

| Menu Item | Description |
|--|---|
| <IT Universe Manager context menu options> | The regular context menu for the topology map in IT Universe Manager is also available from the View Explorer pane. For details on the menu options, see “IT Universe Manager Context Menu” on page 71. |
| Add | Adds the selected CI to the current model or view. Note: This feature only appears in the Modeling Studio. |

| Menu Item | Description |
|---------------------------------|--|
| Add as related CI | Adds the selected CI as a related CI to the current model. Note: This feature only appears in the Modeling Studio. |
| Generate View from Model | Select to create a view based on the current model. The Creating New View dialog box opens which enables you to select a perspective to apply. Note: This feature only appears in the Modeling Studio. |
| Get Related CIs | Select to view a related CIs map for the selected CI. For details, see “IT Universe Manager Context Menu” on page 71. Note: This feature only appears in the Modeling Studio. |
| Open Selected Model | Opens the selected model in the Model Editor. Note: This feature only appears in the Modeling Studio. |
| Properties | Opens the Properties page for the selected CI. For details, see “Configuration Item Properties Dialog Box” on page 53. |

Troubleshooting and Limitations

This section includes the following topics:

Unavailable Views and CIs

The View list in View Explorer may not display all views in the CMDB, or it may not display the contents of a view, for any of the following reasons:

- The View list includes only the views for which you have the necessary permissions. To set permissions, select **Admin > Settings > Users and Roles**. For more information, see “Users and Roles User Interface” on page 641.
- Views that are currently inactive appear in red in the View list, but they cannot be selected. In IT Universe Manager, inactive views appear in faded text.

- ▶ Out-of-the-box views for which you do not have a license may appear in the View list, but these views do not contain CIs. For information on the out-of-the-box views, see “Predefined Folders and Views” on page 132.

Note: After deleting one or more nodes from a TQL, it can take time for changes to be updated to the view; meanwhile, the removed CIs appear in the view. If you select one of these CIs before it is updated, an error message is displayed. Click the **Refresh** button to update the view.

Part VI

Topology Map

37

Working with Topology Map

This chapter provides information on Topology Map.

This chapter includes:

Concepts

- ▶ Topology Map Overview on page 689
- ▶ Handling Large Views on page 690

Reference

- ▶ Topology Map User Interface on page 690

Topology Map Overview

The Topology Map provides a graphical display of a view. All the CIs in a given layer of the view are represented by icons and the connecting lines represent relationships. You can select a CI in the Topology Map or in View Explorer in the left pane. You can also drill down in View Explorer to display different layers of the view in the Topology Map.



If an icon appears with a downward arrow in the Topology Map, there is an additional CI layer beneath it, created by a parent or child folding rule.

The toolbar and Main Menu above the Topology Map enable you to zoom in, change the layout of the Topology Map, and print the Topology Map. Additional functionality is available from the context menu by right-clicking a CI in the Topology Map or in View Explorer.

Handling Large Views

The Topology Map cannot display a view with more than 900 CIs in a single layer. When you select a view which contains a layer with more than this number of CIs, the Topology Map appears empty.

To handle large views, use one of the following methods:

- ▶ Reduce the TQL query results by redefining the view in View Manager. For details, see “Refine Node Type Dialog Box” on page 386.
- ▶ Define different folding rules or Group By rules for the view to redistribute the CIs among the view’s layers. For details on defining folding rules, see “Add Folding Rules to Relationships” on page 145.
- ▶ Reset the maximum number of CIs allowed in the configuration parameters. Select the **Foundations** context in Infrastructure Settings Manager. Select the **Max Object Count GUI for TS** parameter under **UCMDB common – Viewing Settings**. However, be aware that increasing the maximum number of CIs per layer may significantly slow down the redrawing of the Topology Map.

For details regarding Infrastructure Settings Manager, see “Infrastructure Settings Manager User Interface” on page 454.

Topology Map User Interface

This section describes:

- ▶ Export Map to Image Dialog Box on page 691
- ▶ Layout Properties Dialog Box on page 692
- ▶ Main Menu on page 713
- ▶ Print Dialog Box on page 714
- ▶ Print Preview Dialog Box on page 715
- ▶ Print Setup Dialog Box on page 715
- ▶ Toolbar Options on page 717

Export Map to Image Dialog Box

| | |
|--------------------------|---|
| Description | Enables you to save a topology map to a file. To access: From a topology map, select Operations > Export Map to Image . |
| Included in Tasks | “Print and Save a Topology Map to File” on page 526 |

The following elements are included (unlabeled GUI elements are shown in angle brackets>):

| GUI Element (A–Z) | Description |
|---|---|
|  | Move the indicator left or right to set the required quality of the printed map on the scale. 100 means that the quality is excellent. |
| Actual Size | Save the view so that the node sizes are at maximum. |
| Current Zoom Level | Save the view as you see it on the topology map. For example, if you have used the Interactive Zoom mode to decrease the view magnification, the nodes also appear smaller in the saved view. For details, see “Interactive Zoom” on page 720. |
| Custom | Specify the size of the view you want to save in the Width and Height boxes. |
| Draw Grid | Draw a grid in the graph. |
| File Name | Specify the required file name and location (or click Browse to search for the file and location). |
| Fit in Canvas | Expand or shrink the view so that it fits in the window. |
| Image Quality (0-100) | Enter a value to set the required quality of the printed map on the scale. 100 means that the quality is excellent. |
| Selected Objects Only | Saves only the nodes/CIs and their relationships that you selected in the map. |
| Type | Select the required file format. |
| Visible Window Only | Saves only the part of the graph that appears in the window. |



Layout Properties Dialog Box



| | |
|------------------------------|---|
| Description | <p>Enables you to customize the layout of a specific layer in a view, to achieve the clearest presentation possible and to better understand and monitor the managed data.</p> <p>You define the layout of a view's layers by assigning logical positions for the nodes and relationships that appear in a layer. You customize the layer layouts by modifying the default values.</p> <p>Note: You set layout definitions for a specific layer only. The definitions cannot be saved for a different layer or a different view.</p> <p>To access: Select Layout > Layout Properties.</p> |
| Important Information | Parameter values are in pixels. |

Circular Tab

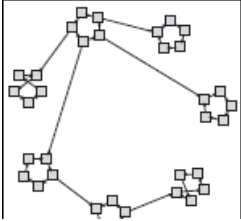

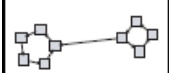
| | |
|--------------------|--|
| Description | <p>Enables you to group a graph's nodes into groups or clusters based on the grouping options you select. It is particularly suited for visualizing ring and star network topologies, and for link analysis.</p> <p>The Circular tab has the following areas:</p> <ul style="list-style-type: none"> ▶ Clustering area. Specifies the ratio between the average cluster size and the number of clusters as well as the minimum and maximum number of clusters in a layer. ▶ Cluster Layout Style area. Displays clusters either in a symmetric or circular layout style. ▶ Layout Quality area. Adjusts the quality of the layout produced to fit your application's needs. The quality reflects the number of steps or the method used to produce the layout. For example, high quality is sharper but takes more time to set the layout. ▶ Spacing area. Sets the spacing around each node within the same cluster and between clusters. <p>To access: Click the Circular tab in the Layout Properties dialog box.</p> |
|--------------------|--|

The following elements are included (unlabeled GUI elements are shown in angle brackets>):

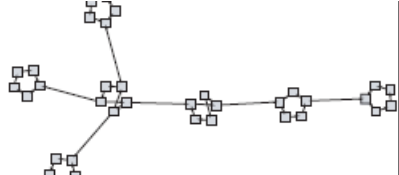
| GUI Element (A–Z) | Description |
|--------------------------------|--|
| Circular | <p>Displays clusters in a circular layout style.</p>  |
| Cluster Spacing | <p>Sets the spacing between clusters.</p> <p>Default value: 50</p> <p>This illustration shows smaller cluster spacing.</p>  <p>This illustration shows larger cluster spacing.</p>  |
| Cluster Size Multiplier | <p>Specifies the ratio between the average cluster size and the number of clusters. The size of a cluster is defined as the sum of the weights of all nodes in the cluster. You can assign a weight value to each node.</p> |
| Draft | <p>Sets the layout to draft quality.</p> |
| Default | <p>Sets the layout to default quality.</p> |
| Max Number of Clusters | <p>The maximum number of clusters in a layer.</p> |
| Min Number Of Clusters | <p>The minimum number of clusters in a layer.</p> |

| GUI Element (A–Z) | Description |
|----------------------------|--|
| <p>Node Spacing</p> | <p>Sets the spacing around each node within the same cluster. The larger the spacing, the more nodes there are on the cluster boundary.</p> <p>Default value: 10</p> <p>This illustration shows smaller node spacing.</p>  <p>This illustration shows larger node spacing.</p>  |
| <p>Proof</p> | <p>Sets the layout to proof quality.</p> |
| <p>Symmetric</p> | <p>Displays clusters in a symmetric layout style.</p>  |

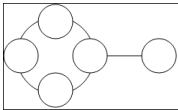
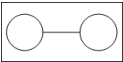
Disconnected Tab

| | |
|---------------------------|---|
| <p>Description</p> | <p>Enables you to define general layout parameters for disconnected nodes and connected components.</p> <ul style="list-style-type: none"> ▶ A disconnected node is a node that is not connected to any other node. ▶ A disconnected component is a component that is not connected to any other component. It contains a set of nodes that can be connected to each other. <p>This illustrates a connected component with five nodes:</p>  <p>This illustrates a connected component with two nodes:</p>  <p>This illustrates four disconnected components, each made up of a single, disconnected node:</p>  <p>The Disconnected tab has the following areas:</p> <ul style="list-style-type: none"> ▶ Aspect Ratio area. This setting affects the placement of components with respect to each other only, and not the layout of each individual component. The setting has no effect if the graph is connected. ▶ Components area. The spacing between the components in a disconnected graph consists of both a constant value and a proportional value based on the sizes of the components. ▶ Disconnected Nodes. The spacing between the nodes in a disconnected graph consists of both a constant value and a proportional value based on the sizes of the nodes. <p>To access: Click the Disconnected tab in the Layout Properties dialog box.</p> |
|---------------------------|---|

The following elements are included (unlabeled GUI elements are shown in angle brackets>):

| GUI Element (A–Z) | Description |
|----------------------------------|---|
| Automatic | The layout is performed automatically. |
| Constant Spacing | Set constant spacing (horizontal and vertical) around each disconnected component. Default value: 20 |
| Custom | Sets a specific aspect ratio. Default value: 1.0 |
| Detect Components | Select this option to view the disconnected components. You can specify that all components be laid out together or individually, regardless of the other components. If the grouping for components is selected, each component is laid out, and the resulting components are packed together. |
| Detect Disconnected Nodes | Select this option to view the disconnected nodes. You can specify that disconnected nodes be grouped into one component or laid out individually. |
| Proportional Spacing | Set spacing (horizontal and vertical) that is proportional to the size of the component around each disconnected component. Default value: 0.05 |

Hierarchical Tab

| | |
|-------------------------------------|---|
| <p>Description</p> | <p>Shows the precedence relationships that can represent organizational or information management system dependencies, as well as process models, software call graphs, and work flows. The hierarchical layout emphasizes dependencies by placing the nodes at different levels.</p> <p>The Hierarchical tab has the following areas:</p> <ul style="list-style-type: none"> ▶ Backward Edges area. Specifies how backward relationships are displayed in the hierarchical layout. ▶ Horizontal Spacing area. Enables you to set the minimum horizontal distance between two neighboring nodes at each level. ▶ Layout Quality area. Enables you to adjust the quality of the layout produced to fit your application's needs. The quality reflects the number of steps or the method used to produce the layout. For example, high quality is sharper but takes more time to set the layout. ▶ Level Alignment area. Enables you to set the way nodes are vertically aligned. ▶ Orientation. Enables you to set the orientation of the hierarchy. ▶ Orthogonal Routing area. Enables you to set the type of relationship between CIs. This option is useful when layers have nodes with a very large number of connecting relationships. ▶ Polyline Routing area. Routes edges as one or more straight line segments with arbitrary angles. Polyline routed edges are prevented from overlapping by adding extra segments. ▶ Vertical Spacing area. Enables you to set the minimum vertical distance between two neighboring nodes on different levels. <p>To access: Click the Hierarchical tab in the Layout Properties dialog box.</p> |
| <p>Important Information</p> | <p>Orthogonal Routing is currently not supported.</p> |

The following elements are included (unlabeled GUI elements are shown in angle brackets>):

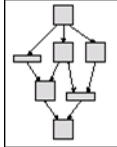
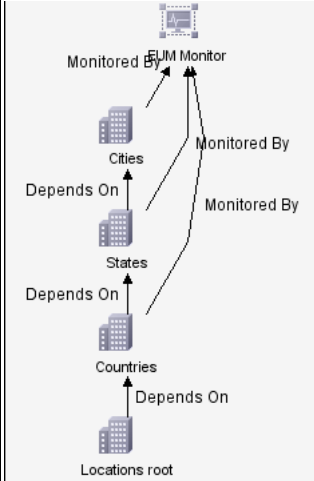
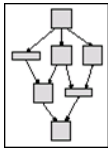
| GUI Element (A-Z) | Description |
|----------------------|---|
| Bottom | <p>This illustration shows that the bottom of the nodes at the same level of the hierarchy are aligned.</p>  |
| Bottom To Top | <p>The children are located below the parent (in the example, Alignment = Center).</p>  |
| Center | <p>This illustration shows that the center of the nodes at the same level of the hierarchy are aligned.</p>  |
| Default | Sets the layout to default quality. |

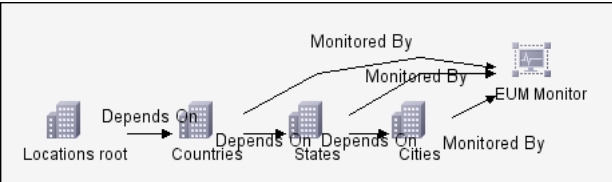
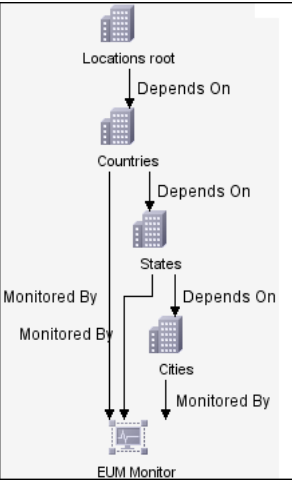
| GUI Element (A-Z) | Description |
|-----------------------------------|--|
| Draft | Sets the layout to draft quality. |
| Left To Right | <p>The children are located to the left of the parent (in the example, Alignment = Center).</p>  |
| Minimum Backward Edges | Sets the number of number of backward relationships displayed in a layer to a minimum. |
| Optimize For Feedback Flow | Sets the number of number of backward relationships displayed in a layer to a maximum. This mode is more appropriate for flow charts. |
| Orthogonal | <p>For orthogonal lines between nodes/CIs.</p>  |

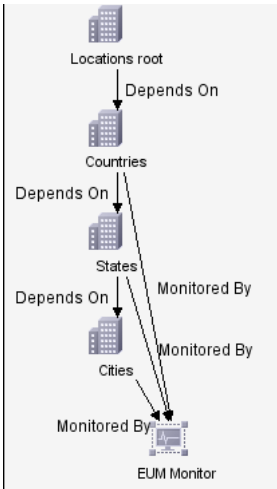
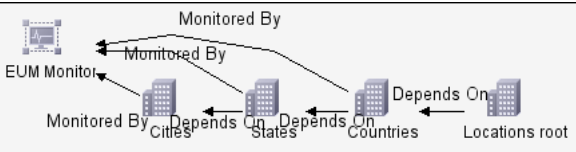
| GUI Element (A-Z) | Description |
|-----------------------------|---|
| <p>Polyline</p> | <p>For straight lines between nodes/CIs.</p>  <pre> graph TD LR[Locations root] -- Depends On --> C[Countries] C -- Depends On --> S[States] S -- Depends On --> CI[Cities] LR -- Monitored By --> EM[EUM Monitor] C -- Monitored By --> EM S -- Monitored By --> EM CI -- Monitored By --> EM </pre> |
| <p>Proof</p> | <p>Sets the layout to proof quality.</p> |
| <p>Right To Left</p> | <p>The children are located to the right of the parent (in the example, Alignment = Center).</p>  <pre> graph RL LR[Locations root] -- Depends On --> C[Countries] C -- Depends On --> S[States] S -- Depends On --> CI[Cities] LR -- Monitored By --> EM[EUM Monitor] C -- Monitored By --> EM S -- Monitored By --> EM CI -- Monitored By --> EM </pre> |

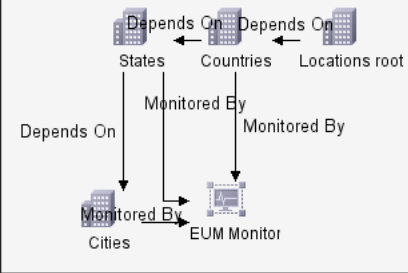
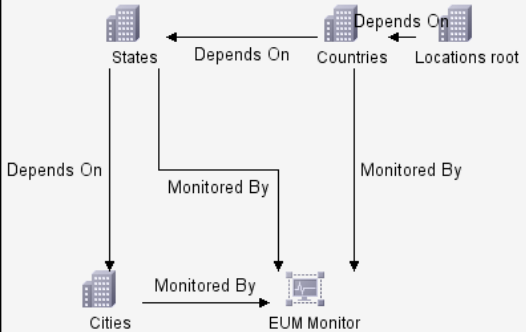
| GUI Element (A–Z) | Description |
|--|--|
| <p>Spacing Between Edges (in the Horizontal Spacing area)</p> | <p>This setting is available only when you select Routing > Orthogonal. It sets a horizontal space between edges in the graph.</p> <p>Default value: 12</p> <p>This illustration shows smaller edge spacing.</p>  <p>This illustration shows larger edge spacing.</p>  |

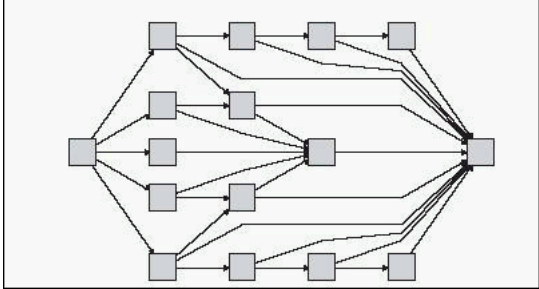
| GUI Element (A–Z) | Description |
|--|---|
| <p>Spacing Between Bends</p> | <p>This setting is available only when you select Routing > Polyline. Polyline routing routes edges (connecting lines) as one or more straight line segments with arbitrary angles. Path nodes are added automatically to prevent the edges (connecting lines) from overlapping.</p> <p>Default Value: 12</p>  |
| <p>Spacing Between Edges (in the Vertical Spacing area)</p> | <p>This setting is available only when you select Routing > Orthogonal. It sets a vertical space between edges in the graph.</p> <p>Default value: 12</p> |
| <p>Spacing Between Nodes (in the Vertical Spacing area)</p> | <p>Sets a vertical space around each node in the level.</p> <p>Default value: 28</p> |

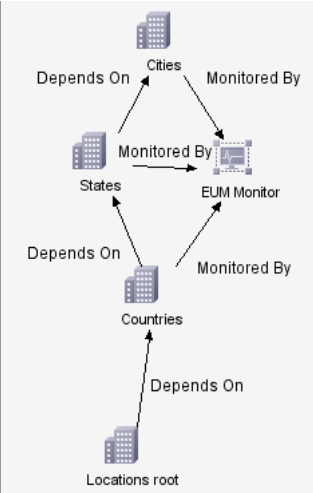
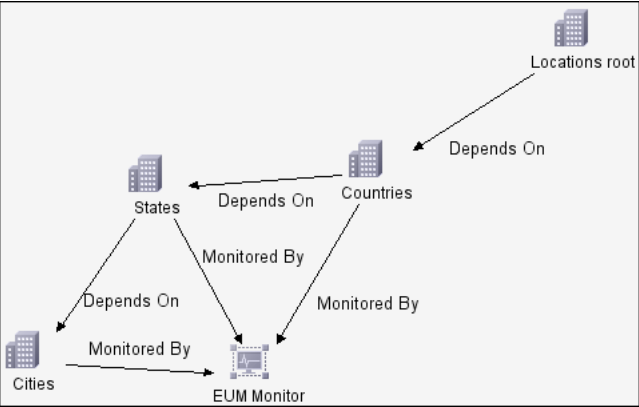
| GUI Element (A-Z) | Description |
|--|--|
| <p>Spacing Between Nodes (in the Horizontal Spacing area)</p> | <p>Sets a space around each node horizontally in the layer. Default value: 20</p> <p>This illustration shows smaller node spacing.</p>  <p>This illustration shows larger node spacing.</p>  |

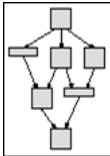
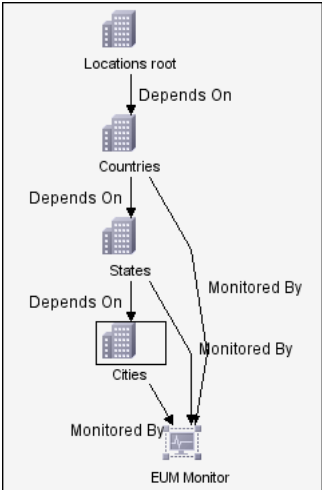
| GUI Element (A-Z) | Description |
|-----------------------------|--|
| <p>Top</p> | <p>This illustration shows that the top of the nodes at the same level of the hierarchy are aligned.</p>  |
| <p>Top To Bottom</p> | <p>The children are located above the parent (in the example, Alignment = Center).</p>  |

| GUI Element (A–Z) | Description |
|-------------------------------|--|
| Undirected Layout | Edge direction is not used to build the levels of the hierarchical drawing. |
| Variable Level Spacing | <p>Variable level spacing adjusts the spacing between pairs of neighboring levels according to the density of edges between the levels.</p> <p>If the drawing's edges are orthogonally routed, this ensures the desired vertical spacing between horizontal edges (in a top-to-bottom or bottom-to-top layout) routed between levels.</p> <p>If the routing is polyline, variable level spacing makes it easier to distinguish among edges in very dense drawings.</p> |

Orthogonal Tab

| | |
|--------------------|--|
| Description | <p>Enables you to set orthogonal layout route relationships horizontally and vertically. This results in relationships bending at 90-degree angles only.</p> <p>The Orthogonal tab has the following areas:</p> <ul style="list-style-type: none"> ▶ Aspect Ratio area. Enables you to set the layout's proportions. This only affects the placement of components with respect to each other, not the layout of each individual component. The layout's proportions have no effect if the graph is connected. ▶ Horizontal Spacing area. Enables you to set the minimum horizontal distance between nodes. ▶ Layout Quality area. Enables you to adjust the quality of the layout produced to fit your application's needs. The quality reflects the number of steps or the method used to produce the layout. For example, high quality is sharper but takes more time to set the layout. ▶ Vertical Spacing area. Enables you to set the minimum vertical distance between nodes. <p>To access: Click the Orthogonal tab in the Layout Properties dialog box.</p> |
|--------------------|--|

| | |
|------------------------------|--|
| Important Information | The Fix Node Sizes option is currently not supported. |
|------------------------------|--|

The following elements are included (unlabeled GUI elements are shown in angle brackets>):

| GUI Element (A–Z) | Description |
|---|---|
| Automatic | The layout is performed automatically. |
| Custom | Specify the aspect ratio. Default value: 1.0 |
| Default | Set the layout to default quality. |
| Disabled | Disables the aspect ratio. |
| Draft | Set the layout to draft quality. |
| Proof | Set the layout to proof quality. |
| Spacing Between Edges (in the Horizontal Spacing area) | Set a space between elements in the layer. Default value: 12 |
| Spacing Between Nodes (in the Horizontal Spacing area) | Set a space around each node in the layer. Default value: 20 |
| Spacing Between Edges (in the Vertical Spacing area) | Set a space between elements in the layer. Default value: 12 |
| Spacing Between Nodes (in the Vertical Spacing area) | Sets a space around each node in the layer. Default value: 20 |

Routing Tab

| | |
|---------------------------|--|
| <p>Description</p> | <p>Enables you to produce drawings that leave nodes essentially where they are, and reroute the lines orthogonally.</p> <div data-bbox="611 336 1206 795" style="text-align: center;"> <p>Before After</p> </div> <p>The Routing tab has the following areas:</p> <ul style="list-style-type: none"> ▶ Horizontal Spacing area. Enables you to set the horizontal space around each node. ▶ Vertical Spacing area. Enables you to set the vertical space around each node. <p>To access: Click the Routing tab in the Layout Properties dialog box.</p> |
|---------------------------|--|

The following elements are included (unlabeled GUI elements are shown in angle brackets>):

| GUI Element (A-Z) | Description |
|---------------------------|---|
| Fix Node Positions | Maintain the position of all the nodes in the display. Clear this option for the layout to move the nodes if it is necessary to improve the layout. The movement is minimal, avoids overlaps, and minimizes bend points. |
| Fix Node Sizes | Maintain the size of a node. Clear this option if you want the layout to increase the size of a node if it is necessary to maintain the specified relationship spacing when more than one relationship is attached to the same node side. |

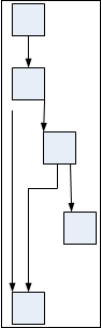
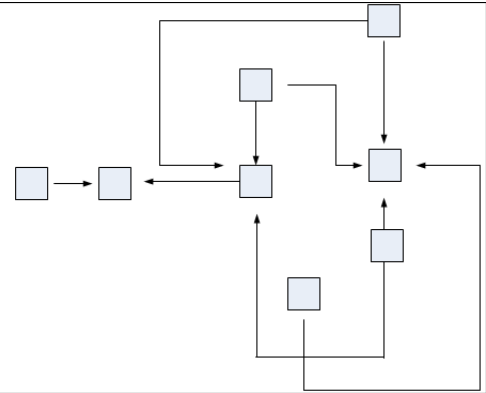
| GUI Element (A–Z) | Description |
|--|--|
| <p>Spacing Between Edges (in the Horizontal Spacing area)</p> | <p>Sets the horizontal space between any two neighboring parallel lines. Line spacing can also affect the size of a node to which many lines are attached, unless the node is set to remain fixed at its current size. The settings for line spacing are constant values.</p> <p>Default value: 12</p> <p>The following illustrates smaller line spacing:</p>  <p>The following illustrates larger line spacing:</p>  |
| <p>Spacing Between Edges (in the Vertical Spacing area)</p> | <p>Set the vertical space between any two neighboring parallel lines. Spacing between lines can also affect the size of a node to which many edges are attached, unless the node is set to remain fixed at its current size. The settings for edge spacing are constant values.</p> <p>Default value: 12</p> |

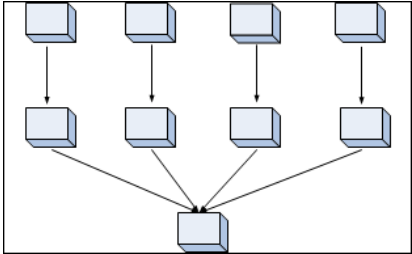
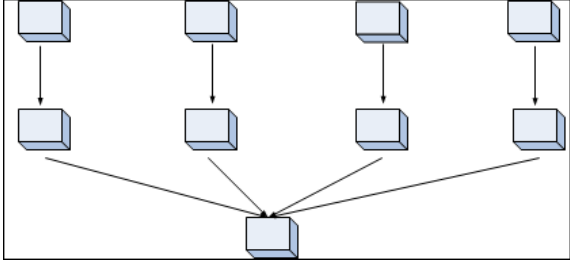
| GUI Element (A-Z) | Description |
|--|---|
| <p>Spacing Between Nodes (in the Horizontal Spacing area)</p> | <p>Sets the horizontal space around each node in the layer. Default value: 20</p> <p>The following illustrates smaller node spacing:</p>  <p>The following illustrates larger node spacing:</p>  |
| <p>Spacing Between Nodes (in the Vertical Spacing area)</p> | <p>Set the vertical space around each node in the layer. Default value: 20</p> |

Symmetric Tab

| | |
|--------------------|---|
| Description | <p>Displays a clear representation of complex networks. The symmetric layout emphasizes the symmetries that may occur in a graph.</p> <p>This tab consists of the following areas:</p> <ul style="list-style-type: none"> ▶ Layout Quality area. Adjusts the quality of the layout produced to fit your application's needs. The quality reflects the number of steps or the method used to produce the layout. For example, high quality is sharper but takes more time to set the layout. ▶ Spacing Options area. Enables you to adjust the spacing around each node in the layer. <p>To access: Click the Symmetric tab in the Layout Properties dialog box.</p> |
|--------------------|---|

The following elements are included (unlabeled GUI elements are shown in angle brackets>):

| GUI Element (A-Z) | Description |
|-------------------|------------------------------------|
| Default | Set the layout to default quality. |
| Draft | Set the layout to draft quality. |

| GUI Element (A-Z) | Description |
|----------------------------|---|
| <p>Node Spacing</p> | <p>Allows you to set constant horizontal and vertical spacing around each node in the layer. The value you specify is a guideline for the layout, so that it is possible that the spacing for a particular pair of nodes might be different from the one you specified. The larger the node spacing, the farther apart the nodes are spaced in the final layout.</p> <p>Default value: 10</p> <p>The following figure illustrates smaller and larger spacing.</p> <div data-bbox="576 591 1138 852" style="border: 1px solid black; padding: 5px;"> </div> |
| <p>Proof</p> | <p>Set the layout to proof quality.</p> |

 **Main Menu**

| | |
|------------------------------|---|
| Description | Contains the options for working with the topology map. |
| Important Information | The specific options contained within the Main Menu drop-downs are detailed in “Toolbar Options” on page 717. |

The following elements are included (unlabeled GUI elements are shown in angle brackets>):

| GUI Element (A–Z) | Description |
|--------------------------|--|
| Edit | Contains selection options for the topology map. |
| Layout | Contains options for changing the layout of the topology map. |
| Map Item | Contains the topology map context menu options for the current manager. |
| Operations | Contains options for printing or exporting the topology map. |
| Resources | Contains the left pane context menu options for the current manager. Note: In IT Universe Manager, this drop-down is called Configuration Items and in CI Type Manager it is called CI Types . |
| View | Enables you to hide or display the different panes of the topology map. |

 **Print Dialog Box**

| | |
|------------------------------|--|
| Description | Enables you to print the contents of the topology map. To access: Select Operations > Print . |
| Important Information | The results of printing a topology map is similar to a screen capture. Therefore, before printing, it is recommended to: <ul style="list-style-type: none"> ▶ Define your print settings and arrange the contents of the topology map according to your requirements. For details, see “Print Setup Dialog Box” on page 715. ▶ Arrange the contents of the topology map for print. You can use the Layout option and Layout Properties. For details about the layout options, see “Layout” on page 721. For details about layout properties, see “Layout Properties Dialog Box” on page 692. |
| Included in Tasks | “Print and Save a Topology Map to File” on page 526 |

The following elements are included (unlabeled GUI elements are shown in angle brackets>):

| GUI Element (A–Z) | Description |
|--------------------------|---|
| Number of copies | Enter the number of copies you want to print. |
| Properties | Define document properties as required. |

Print Preview Dialog Box

| | |
|--------------------------|--|
| Description | Enables you to preview the content of the topology map before printing. To access: Select Operations > Print Preview . |
| Included in Tasks | “Print and Save a Topology Map to File” on page 526 |

The Print Preview dialog box includes the following menu options (listed alphabetically):

| Menu Item | Description |
|----------------------|---|
| Fit in Canvas | Fit the complete view in the window. |
| Print | Print the map. For details, see “Print Dialog Box” on page 714. |
| Print Setup | Define the print settings for the map. For details, see “Print Setup Dialog Box” on page 715. |
| Zoom | Focus on specific details of the map. For details, see “Interactive Zoom” on page 720. |

Print Setup Dialog Box

| | |
|--------------------------|---|
| Description | Enables you to define the print settings for a topology map. To access: Select Operations > Print Setup . |
| Included in Tasks | “Print and Save a Topology Map to File” on page 526 |





The following elements are included (unlabeled GUI elements are shown in angle brackets>):



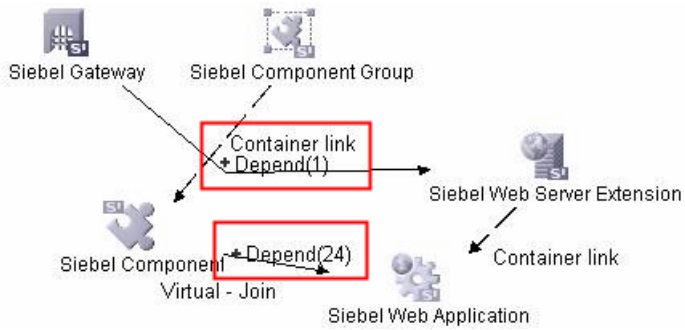

| GUI Element (A–Z) | Description |
|--------------------|---------------------------------|
| Actual Size | Print the view as it really is. |
| Color | Set the text color. |





| GUI Element (A–Z) | Description |
|--------------------------------|---|
| Font | Set the required font. |
| Page Setup | Set the printer settings. |
| Pages | Divide the map into rows and columns and print each section separately. Enter the number of columns and rows in the Page Columns and Page Rows boxes. |
| Position | Select the position of the caption from the Position list. |
| Print Background | Print the background behind the view. |
| Print Border | Print the map with a border. Click Color to select the required border color. |
| Print Caption | Enter the caption in the text area and click Font to select the required custom font. |
| Print Crop Marks | Print the crop marks. |
| Print Current Selection | Print the selected nodes and their relationships. |
| Print Current Window | Print the part of the view that appears in the window. |
| Print Entire Drawing | Print the complete view. |
| Print Page Numbers | Print the page numbers. |
| Zoom Level | Print the view at the current zoom level. |

Toolbar Options



The following table contains a description of each Topology Map toolbar option, organized alphabetically.



| Button | Option Name | Use This Option to... |
|---|-----------------------------------|---|
| | Add Background Image | <p>Add a background image to a view. For details, see “Add Background Image Dialog Box” on page 50.</p> <p>To access: Select Layout > Add Background Image.</p> <p>Note: This option is only active in IT Universe Manager and Topology View application.</p> |
|  | Additions Count | <p>Calculate the number of instances that are created as a result of an Enrichment Rule. The number of TQL node instances and relationships that are created appear next to the Enrichment nodes/relationships, as seen in the figure below.</p>  <p>Note: This option appears in the toolbar in Enrichment Manager only.</p> |
|  | Calculate TQL Result Count | <p>Calculate the number of instances found for each TQL node/relationship.</p> |
|  | Candidates for Deletion | <p>Identify the CIs in the current view which are candidates for deletion with the following icon  .</p> <p>Note: This option appears in the toolbar in the Topology View application only.</p> |







| Button | Option Name | Use This Option to... |
|---|--------------------------------|--|
| | Change Label Length | Enter the maximum number of characters that the labels should contain. To access: Select Layout > Change label length . |
|  | Change Timeframe | Open the Change Timeframe dialog box, which enables you to set the period for the display of added or changed CI indicators. Note: This option appears in the toolbar in Topology View application only. |
| | CI Types Tree | Toggle between hiding and displaying the CI Type Selector at the right of the screen. To access: Select View > CI Types Tree . |
|  | Clear Correlation | Clear the Topology View of the statuses of the trigger and affected CIs for the state Change . CI statuses appear only after using the Run Correlation dialog box to run an Impact Analysis report on a set of existing Correlation rules. For details, see “Run Correlation Dialog Box” on page 528. For details on Correlation rules, see “Correlation Manager User Interface” on page 185. Note: This option appears in the toolbar in the Topology Map in the Topology View application only. |
|  | Create Relationship | In most managers, create a relationship between two existing TQL nodes. For details, see “Add Nodes and Relationships to a TQL Query” on page 330. In IT Universe Manager, create a relationship between existing CIs. For details, see “Attaching Existing CIs” on page 43. |
|  | Delete Selected Item(s) | Delete a CI from IT Universe Manager, a node from View Manager, a TQL node from Query Manager, Correlation Manager, Report Manager, or Enrichment Manager. |
| | Direct Links Wizard | Open the Direct Links wizard, which enables you to create a direct link to a specific CI or view. For details, see “Generate Direct Link User Interface” on page 413. |
| | Drag Map | Drag the view. To access: Open the drop-down menu in the Mode box or select View > Drag Map . |

| Button | Option Name | Use This Option to... |
|---|------------------------------------|---|
|  | Drill Down One Layer | <p>Move down one level in the topology map. This option is enabled only if there is an additional CI layer below it, created by a parent or child folding rule as defined in View Manager. For details on folding rules, see “Adding Folding Rules to Relationships” on page 44.</p> <p>Note: This option appears only in IT Universe Manager and Topology View application.</p> |
| | Entities Tree | <p>Toggle between hiding and displaying the manager specific entities tree at the left of the screen.</p> <p>To access: Select View > Entities Tree.</p> |
| | Export Map to Image | <p>Save the topology map to a file. For details, see “Export Map to Image Dialog Box” on page 691.</p> <p>To access: Select Operations > Export Map to Image.</p> |
|  | Filter DB Results | <p>Open a dialog box which displays the number of related CIs by type. Select the CI type you want to appear in the Topology Map results.</p> <p>Note: This option appears only in IT Universe Manager and the Topology View application.</p> |
|  | Fit to Window | <p>Fit the complete map in the window.</p> |
|  | Generate Related CIs Report | <p>Display the Get Related CIs Report for the selected CI. For details, see “Get Related CIs Report” on page 60.</p> <p>Note: This option appears only in IT Universe Manager and Topology View application.</p> |
|  | Go Up One Layer | <p>Move up one level in the topology map. This option is enabled only if there is an additional CI layer above it, created by a parent or child folding rule as defined in View Manager. For details on folding rules, see “Adding Folding Rules to Relationships” on page 44.</p> <p>Note: This option appears only in IT Universe Manager and the Topology View application.</p> |

| Button | Option Name | Use This Option to... |
|---|--------------------------------------|--|
| | Hide All Inheritance From Map | <p>Toggle between showing and hiding Inheritance_f relationships and their connecting node.</p> <p>To access: Select Layout > Hide All Inheritance From Map.</p> <p>Note: This option is only active in the toolbar in CI Type Manager.</p> |
| | Hide All Node Labels | <p>Toggle between showing or hiding the CI/CIT/node/pattern labels.</p> <p>To access: Select Layout > Hide All Node Labels.</p> |
| | Hide All Relationship Labels | <p>Toggle between showing or hiding the relationship labels.</p> <p>To access: Select Layout > Hide All Relationship Labels.</p> |
| | Hide All Relationships | <p>Toggle between showing and hiding the relationships in the displayed map.</p> <p>To access: Select Layout > Hide All Relationships.</p> |
|  | Hide Panes/Restore Panes | <p>Toggle between the regular display and a full-screen display of the topology map.</p> |
| | Information Pane | <p>Toggle between hiding and displaying the Information Pane at the bottom center of the screen.</p> <p>To access: Select View > Information Pane.</p> |
| | Interactive Zoom | <ul style="list-style-type: none"> ▶ Decrease the view magnification by clicking and pushing the pointer upwards. ▶ Magnify the view by clicking and pulling the pointer downwards. <p>To access: Open the drop-down menu in the Mode box or select View > Interactive Zoom.</p> |
| | Layout Properties | <p>Define the view's layer layout, by assigning positions for the nodes and relationships of the view. For details, see "Layout Properties Dialog Box" on page 692.</p> <p>To access: Select Layout > Layout Properties.</p> |

| Button | Option Name | Use This Option to... |
|---|-----------------------|--|
| | Layout | <p>Select the layout display from the list. The options are:</p> <ul style="list-style-type: none"> ▶ Hierarchical. Enables you to display the precedence relations in the topology map. ▶ Symmetric. Enables you to display clear representations of complex networks. ▶ Circular. Groups a graph's nodes into groups or clusters. ▶ Manual. Enables you to display the changes you have made manually to the topology map. ▶ Orthogonal. Enables you to display views of outstanding clarity that are achieved by employing only horizontal and vertical edge routing. <p>Note: Select Layout > Save Layout to save the selected layout. For further details about each of the options, see “Layout Properties Dialog Box” on page 692.</p> |
| | Map overview | <p>Open a small window with a copy of the topology map. This is useful in large views when zooming in.</p> <p>To access: Select Layout > Map Overview.</p> |
| | Navigation | <p>Take the pointer to the next connected CI/CIT/TQL node in a clockwise direction.</p> <ul style="list-style-type: none"> ▶ Left-click to move in a clockwise direction. ▶ Right-click to point to the next CI/CIT/node/pattern in a clockwise direction. <p>To access: Open the drop-down menu in the Mode box or select View > Navigation.</p> <p>Note: You can use this option only on CI/CIT/nodes/patterns that are connected by relationships.</p> |
|  | New CI | <p>Define a new unrelated CI. For details, see “Working with CIs” on page 37.</p> <p>Note: This option appears in the toolbar in IT Universe Manager only.</p> |
|  | New Related CI | <p>Define a new related CI. For details, see “Working with CIs” on page 37.</p> <p>Note: This option appears in the toolbar in IT Universe Manager only.</p> |

| Button | Option Name | Use This Option to... |
|---|----------------------------------|---|
| | Place in Center | Place the selected CI/node/CIT/pattern in the center of the map. To access: Select Layout > Place in Center . |
| | Print | Print the contents of the topology map. For details, see “Print Dialog Box” on page 714. To access: Select Operations > Print... |
| | Print Preview | Preview the contents of the map before printing. To access: Select Operations > Print Preview . |
| | Print Setup | Define print settings for printing the topology map. For details, see “Print Setup Dialog Box” on page 715. To access: Select Operations > Print Setup... |
|  | Remove Enrichment Results | Remove the instances created from an Enrichment rule from the CMDB. Note: This option appears in the toolbar in Enrichment Manager only. |
| | Save Layout | Save changes to the layout. To retrieve the layout you have saved, select Manual Layout . To access: Select Layout > Save Layout . Note: This option appears in the toolbar in IT Universe Manager and Topology View application only. |
|  | Select | Select a CI/CIT/TQL node or multiple CIs/CITs/TQL nodes. To access: Open the drop-down menu in the Mode box or select View > Select . |
| | Select All | Select all the CIs and relationships in a selected layer. To access: Select Edit > Select All . |
| | Select All Nodes | Select all the nodes in a selected layer. To access: Select Edit > Select All Nodes . |
|  | Select Columns | Enables you to select the columns to be displayed. For details, see, “Select Columns Dialog Box” in <i>Reference Information</i> . Note: This option is displayed in Text mode of IT Universe Manager only. |

| Button | Option Name | Use This Option to... |
|---|----------------------------|---|
|  | Set Number of Hops | <p>Open a dialog box which enables you to set the degree of separation of the related CIs to appear in the Related in DB selection.</p> <p>Note: This option appears in the toolbar in IT Universe Manager and Topology View application only.</p> |
|  | Show Changes in Map | <p>Display an indicator next to each CI that was added or changed within the selected period as follows:</p> <ul style="list-style-type: none"> ▶  Indicator for an added CI ▶  Indicator for a changed CI <p>You can toggle between hiding and displaying the indicators by clicking the button. When the indicators are displayed, you can double-click on the indicator to open the CI History dialog box, which displays the history for the CI over the selected period.</p> <p>For details on selecting the period, see “Change Timeframe” on page 718.</p> <p>Note: This option appears in the toolbar in Topology View application only.</p> |
|  | Show Schedule Info | <p>Display the scheduling information for the selected job. For details, see “Discovery Scheduler Dialog Box” in <i>Discovery and Dependency Mapping Guide</i>.</p> <p>Note: This option appears in the toolbar in the Dependency Map tab of DDM. For details, see “Dependency Map Tab” in <i>Discovery and Dependency Mapping Guide</i>.</p> |
|  | Sort Order | <p>Enables you to set the order of the visible columns. For details, see, “Sort Column Content Dialog Box” in <i>Reference Information</i>.</p> <p>Note: This option is displayed in Text mode of IT Universe Manager and the Topology View application only.</p> |
| | Straighten | <p>Straightens any selected relationship between two nodes that has angles.</p> <p>To access: Select Layout > Straighten.</p> |

| Button | Option Name | Use This Option to... |
|--------|-------------------------|---|
| | User Preferences | <p>Opens the User Preferences dialog box which enables you to reset warning message preferences. For details, see “User Preferences Dialog Box” on page 400.</p> <p>To access: Select Edit > User Preferences.</p> |
| | Zoom | <p>Zoom in on a specific section of the topology map by clicking and drawing a selection rectangle around the part to magnify. The area you select is displayed at the highest percentage that fits in the topology map.</p> <p>To access: Open the drop-down menu in the Mode box or select View > Zoom.</p> |

Index

A

- access rights
 - assigning 654
- Action Definition dialog box
 - Scheduler 489, 508
- adapters
 - packages 460
- Add /Edit Relationship Folding Rule dialog box 146
- Add Attributes dialog box
 - Topology Report Manager 257
- Add Background Image dialog box 50
- Add Calculated Relationship dialog box 353
- Add Compound Relationship dialog box 355
- Add Function dialog box
 - Topology Report Manager 258
- Add Join Relationship dialog box 359
- Add New User Wizard
 - Role List page 643
 - User Details page 642
 - User Name and Password page 642
- Add Triplet dialog box 364
- Add/Edit Attribute dialog box 217
- Add/Edit Relationship dialog box 362
- Add/Remove Relationship dialog box 221
- adding
 - Enrichment nodes and relationships to a TQL query 331
 - nodes and relationships to a TQL query 330
- Affected Nodes dialog box
 - Correlation Manager 186
- aging
 - and the CI Lifecycle 535
 - overview 536
- aging mechanism
 - for CIs 40

- Aging Status tab
 - in CI Lifecycle window 542
- Asset report
 - overview 577
- Asset report page 578
- assigning
 - access rights 654
- Attribute Columns dialog box
 - Topology Report Manager 259
- attribute operator definitions 346
- attribute properties
 - grouping CIs by 137
- attribute states
 - defining 500
- Available Templates 149, 150, 153, 155, 157

B

- browse mode
 - displaying a view 670
- business CI models 86
 - building 94
- business view
 - building 133

C

- calculated relationship types 409
- Calculated relationships
 - creating 212
- calculated relationships
 - overview 407
- change history of a CI
 - viewing 588
- change history of a relationship
 - viewing 589

Index

- Change report 585
 - CI History page 590
 - overview 585
- Change Report page 586
- Changed Applications report 619
- Changed Views report 621
- Choose Operation for Selected Item dialog box 98
- Choose Resources to Export dialog box
 - Package Manager 469
- CI comparison
 - overview 567
- CI Conditional Search dialog box 100
- CI History page
 - Change report 590
- CI Lifecycle
 - aging 535
 - Aging Status tab 542
 - Filter dialog box 549
 - filter results 540
 - generate data 540
 - overview 537
- CI Lifecycle page 548
- CI Lifecycle report 543
- CI Properties dialog box 53
- CI Selector
 - see View Explorer
- CI Type log 24
- CI Type Manager 205, 221
 - Attached Menu tab 235
 - Attributes tab 228
 - context menu 225
 - Default Label tab 238
 - Details tab 227
 - Icon tab 233
 - Qualifiers tab 230
 - Triplets tab 232
- CI Types
 - assigning a calculated relationship 212
 - assigning icons 210
 - assigning qualifiers 210, 211, 212
 - attributes 207
 - creating 209
 - customizing the menu 210, 211
 - defining 209, 211, 212
 - defining default labels 210, 212
 - overview 206
 - relationships 208
 - setting attributes 209, 211
 - view descriptions 216
- CI/Relationship History dialog box 51
- Circular tab
 - Layout Properties dialog box 692
- CIs
 - adding to Discovery job 71, 82
 - attaching existing 43
 - automatic deletion with aging mechanism 40
 - comparing 568
 - creating 45
 - creating new in view 37
 - creating non-related CIs 38
 - creating related CIs 38
 - deleting 39, 71
 - properties 39
 - removing from Discovery job 71, 82
- CMDB Utilization report 623
- CMDB 19
 - audit short log 26
 - concepts 19
 - creating new CIs 37
 - DAL Log 28
 - enrichment log 27
 - general log 23
 - log files 21
 - notification logs 25
 - Operation Statistics Log 29
 - plug-in log 28
 - relationships for CIs 41
 - server parameters 22
- Compare CIs
 - Find CI by Label dialog box 572
 - Select CI dialog box 573
- Compare CIs user interface 569
- Compare CIs window 570
- Compare Snapshots
 - Find CI by Label dialog box 564
 - Snapshot of <View> dialog box 565
- Compare Snapshots user interface 559
- Compare Snapshots window 559
- comparing CIs 568

- comparing snapshots 557
 - compound relationship 326
 - compound relationships
 - defining 332
 - Conditions of Related CIs dialog box 101
 - configuration items 21
 - configuration management database (CMDB) 19
 - contents and format
 - of packages 459
 - context menu options
 - TQL 339
 - Correlation Definition dialog box
 - Correlation Manager 187
 - Correlation Manager
 - Affected Nodes dialog box 186
 - Correlation Definition dialog box 187
 - Details dialog box 198
 - overview 177
 - Correlation Manager user interface 185
 - Correlation Manager window 189
 - Correlation results
 - retrieving 516
 - Correlation rules
 - create 179
 - validation of TQL queries 403
 - Correlation Rules window 527
 - Correlation State and Trigger Severity dialog box 439
 - create
 - a package 461
 - Create Calculated Relationship wizard 226
 - Create Configuration Item Type wizard 226
 - Attached Menu page 235
 - Attributes page 228
 - Default Label page 238
 - Details page 227
 - Icon page 233
 - Qualifiers page 230
 - Create Custom Package/Edit Package wizard
 - Package Manager 470
 - Create Enumeration Definition dialog box
 - 240
 - Enumeration definition area 242
 - Create List Definition dialog box 240
 - list definition area 241
 - Create New Correlation Rule/ Correlation Rule Properties/ Save As Correlation Rule wizard
 - Rule Groups page 202
 - Create New Correlation Rule/Correlation Rule Properties/Save As Correlation Rule wizard
 - Rule Base TQL Attributes page 201
 - Rule General Attributes page 200
 - Create New Enrichment Rule wizard
 - Rule Base TQL page 317
 - Rule General Attributes page 315
 - Create New Package/Edit Package wizard
 - Package Properties page 470
 - Resource Selection page 471
 - Selection Summary page 476
 - Create New Report wizard
 - Report Base TQL page 265
 - Report Completion page 266
 - Report General Attributes page 263
 - Report Titles page 264
 - Create Relationship wizard 226
 - Create Reveal Path dialog box 103
 - Creating New View dialog box 104
 - Cron expressions 487
- D**
- Database Breakdown report 624, 628
 - DDM
 - login credentials of user with permissions on DDM resources 656
 - define an email recipient
 - Recipients Manager 507
 - defining
 - compound relationships 332
 - join relationships 335
 - map printing settings 715
 - subgraph definitions 337
 - user preferences 650
 - Delete Candidates Overview Report 626
 - deploy
 - a package 462
 - deployed packages
 - displaying using the JMX console 467

Index

- deploying
 - packages using the JMX console 465
- Details dialog box
 - Correlation Manager 198
- Direct Link Parameters – CI Type Selector page
 - Generate Direct Link wizard 418
- Direct Link Parameters – Show Change Report on View page
 - Generate Direct Link wizard 422
- Direct Link Parameters – Show Change Report page
 - Generate Direct Link wizard 420
- Direct Link Parameters – Show CI Neighborhood page
 - Generate Direct Link wizard 424
- Direct Link Parameters – Show CI Properties page
 - Generate Direct Link wizard 425
- Direct Link Parameters – Show Impact Map page
 - Generate Direct Link wizard 427
- Direct Link Parameters – Show Instances Grid page
 - Generate Direct Link wizard 428
- Direct Link Parameters – Show Topology Report page
 - Generate Direct Link wizard 431
- Direct Link Parameters – Start in Mode page
 - Generate Direct Link wizard 436
- Direct Link Parameters page – Show View
 - Generate Direct Link wizard 433
- Direct Link Parameters page – Show View Topology
 - Generate Direct Link wizard 435
- Direct Link Parameters – Show Related CIs page
 - Generate Direct Link wizard 430
- Disconnected tab
 - Layout Properties dialog box 695
- Discovery job
 - adding to a CI 71
 - removing from CIs 71
- Discovery Status tab
 - in Model Management 59

- displaying deployed packages
 - using the JMX console 467

E

- Edit Attribute dialog box
 - Topology Report Manager 260
- Edit Calculated Relationship dialog box 353
- Edit Compound Relationship dialog box 355
- Edit Join Relationship dialog box 359
- Edit Reveal Path dialog box 103
- editing pane
 - View Manager 168
- Element Instances dialog box 368
- Element Instances page
 - TQL Node wizard 399
- Enrichment Manager
 - Node/Relationship Definition dialog box 318
 - overview 297
- Enrichment Manager user interface 303
- Enrichment Manager window 304
- Enrichment nodes and relationships
 - adding to a TQL query 331
- Enrichment rules
 - define 300
 - validations 331
- enumeration definitions 243
 - creating 213
 - workflow 214
- Export Class Model to UML tool 443
 - overview 444
 - plugin input 447
- Export Class Model to UML wizard 448
- Export package dialog box
 - Package Manager 476
- export packages 462
 - using the JMX console 468
- Export Selected Items 450
- Export the Class Model tool 444
- Exporting the Class Model to a UML Tool user interface 448

F

- favorite filters
 - wizard 605
 - wizard, filter properties page 605
 - wizard, filter setting page 606
 - wizard, preview page 608
- Filter CI Instances dialog box 371
- Filter CIs dialog box
 - Topology Report Manager 260
- Filter dialog box
 - CI Lifecycle 549
 - Package Manager 477
 - Scheduler 490
- Find CI by Label dialog box
 - Compare CIs 572
 - Compare Snapshots 564
- Find dialog box
 - Package Manager 478
- Finish page
 - Generate Direct Link wizard 440
- folders
 - predefined 132
- folding rules
 - adding to relationships 44

G

- Generate Direct Link
 - dialog box 414
 - overview 411
 - scenario 413
 - user interface 413
 - wizard 415
- Generate Direct Link wizard
 - Direct Link Parameters – CI Type
 - Selector page 418
 - Direct Link Parameters – Show
 - Change Report on View page 422
 - Direct Link Parameters – Show
 - Change Report page 420
 - Direct Link Parameters – Show CI
 - Neighborhood page 424
 - Direct Link Parameters – Show CI
 - Properties page 425
 - Direct Link Parameters – Show Impact
 - Map page 427

- Direct Link Parameters – Show
 - Instances Grid page 428
- Direct Link Parameters – Show Related
 - CIs page 430
- Direct Link Parameters – Show
 - Topology Report page 431
- Direct Link Parameters – Start in Mode
 - page 436
- Direct Link Parameters page – Show
 - View page 433
- Direct Link Parameters page – Show
 - View Topology page 435
- Finish page 440
- Select CIs dialog box 437
- Select Command page 415
- Get Related CIs report 60
- Gold Master report
 - overview 551
- Gold Master report definition
 - creating 256
- Gold Master report page 552
- Gold Master report pane 261
- group by
 - nested groups 137

H

- Hidden CIs dialog box 104
- Hierarchical tab
 - Layout Properties dialog box 697
- History database log 27
- Host Dependency report
 - overview 581
- Host Dependency report page 582
- Host OS Breakdown report 631

I

- impact map
 - setting state and trigger severity for 439
- infrastructure settings
 - overview 453
- Infrastructure Settings Manager
 - Edit Setting dialog box 455
- Infrastructure Settings Manager page 454

Index

- Insert Relationship dialog box 61
 - Relationship page 62
- instance views. See perspective based views
- IT Universe
 - large views 690
 - relationships 41
 - views 35, 36
- IT Universe Manager
 - CI Properties dialog box 53
 - overview 34
 - Topology Map 67
- IT Universe Manager window 66
- IT Universe model
 - populating 34

J

- Job Definitions dialog box
 - Scheduler 491
- Job Scheduler window
 - Scheduler 495
- join relationship 327
- Join Relationship Condition dialog box 372
- join relationships
 - defining 335

L

- Layout Properties dialog box 692
 - Circular tab 692
 - Disconnected tab 695
 - Hierarchical tab 697
 - Orthogonal tab 705
 - Routing tab 707
 - Symmetric tab 711
- Layout Settings dialog box 374
- LDAP Manager
 - overview 661
 - synchronizing user groups 662
 - user interface 664
- LDAP Manager user interface 664
- linking nodes to application CIs 134
- list definitions 243
 - creating 213
- List of Dependent Views dialog box 147
- log files 21

- logs
 - changing log levels 30
 - lifecycle 23
 - quota 24
 - severity levels 30

M

- Major Application Type Breakdown report 632
- Manage CI Watchpoints dialog box 105
- managed views
 - persistent 127, 151, 154, 158
- map printing settings
 - defining 715
- merging identical instances 138
- Model Editor 106
- Model Management
 - Discovery Status tab 59
- Modeling Studio
 - overview 86
- Modeling Studio page 113

N

- Network Device Breakdown report 634
- New CI dialog box 74
- New Correlation Rule /Correlation Rule
 - Properties/Save As Correlation Rule wizard 199
- New Enrichment Rule/Enrichment Rule
 - Properties/Save As Enrichment Rule wizard 314
- New Model dialog box 114
- New Perspective wizard 148
- New Report/Report Properties/Save As Report wizard
 - 263
- New Template wizard 151
- New TQL Node page
 - TQL Node wizard 393
- New TQL Relationship page
 - TQL Node wizard 395
- New View wizard 154
- New Watchpoint dialog box 115

- Node/Relationship Definition dialog box
 - Enrichment Manager 318
 - Node/Relationship Properties dialog box 375
 - nodes
 - and relationships 21
 - nodes and relationships
 - adding to a TQL query 330
 - Number of Changes report 635
- O**
- Open Model dialog box 116
 - Open Saved Reveal Path dialog box 117
 - Open View dialog box 118
 - Orthogonal tab
 - Layout Properties dialog box 705
 - overview
 - Topology Query Language 324
 - View Explorer 670
 - Overview reports 617
 - overview 617
 - Overview reports user interface 618
- P**
- package
 - create 461
 - deploy 462
 - Package Manager
 - Choose Resources to Export dialog box 469
 - Create Custom Package/Edit Package wizard 470
 - Export package dialog box 476
 - Filter dialog box 477
 - Find dialog box 478
 - Package Manager user interface 469
 - Package Manager window 479
 - Package Properties page
 - Create New Package/Edit Package wizard 470
 - packages
 - administration overview 458
 - contents and format 459
 - deploying using the JMX console 465
 - export 462
 - export using the JMX console 468
 - for federated cmdb adapters 460
 - resources 462
 - troubleshooting and limitations 483
 - undeploying using the JMX console 467
 - pattern views
 - creating 144
 - perspective based views
 - building 88
 - including and excluding child CIs 89
 - Perspective Properties wizard 148
 - perspectives
 - creating 141
 - predefined 133
 - previewing topology map
 - before printing 715
 - printing
 - topology map contents 714
- Q**
- Query Definition/Save Query As/Query Properties dialog box
 - Query Manager 285
 - Query Manager
 - overview 283
 - Query Definition/Save Query As/Query Properties 285
 - user interface 285
 - Query Manager window 288
- R**
- Recipient Manager user interface 508
 - Recipients Manager
 - define an email recipient 507
 - overview 507
 - Recipients Manager window 509
 - Refine Node Type dialog box 386
 - regular expressions
 - adding to default label 239
 - Related CIs in Database Map 80
 - Related CIs in View Map 80
 - Relationship Folding Rules dialog box 162

Index

- relationship rules
 - defining multiple 162
 - Relationships
 - creating 210
 - relationships
 - about 41
 - adding folding rules 44
 - creating 41, 45
 - deleting 44
 - hierarchical 42
 - view descriptions 216
 - visible, in TQL queries 358, 361
 - Remove Resources page
 - Undeploy Package Resource wizard 481
 - Report Base TQL page
 - Create New Report wizard 265
 - Report Completion page
 - Create New Report wizard 266
 - Report General Attributes page
 - Create New Report wizard 263
 - report manager 597
 - creating a schedule 604
 - favorite filters wizard 605
 - favorite filters wizard, filter properties page 605
 - favorite filters wizard, filter setting page 606
 - favorite filters wizard, preview page 608
 - main page 608
 - user interface 605
 - working with 600
 - Report Node Definition dialog box
 - Topology Report Manager 276
 - Report rule
 - defining 246
 - Report Titles page
 - Create New Report wizard 264
 - reports
 - report manager 597
 - report schedules 599
 - reports scheduling a report 599
 - Resource Selection page
 - Create New Package/Edit Package wizard 471
 - resources in packages 462
 - Reveal CIs dialog box 119
 - revealing CIs 90
 - Role and User Selector dialog box 655
 - Role dialog box 644
 - Role List page
 - Add New User Wizard 643
 - Roles page 645
 - root causes 178
 - Routing tab
 - Layout Properties dialog box 707
 - Rule Base TQL Attributes page
 - Create New Correlation Rule/Correlation Rule Properties/Save As Correlation Rule wizard 201
 - Rule Base TQL page
 - Create New Enrichment Rule wizard 317
 - Rule General Attributes page
 - Create New Correlation Rule/Correlation Rule Properties/ Save As Correlation Rule wizard 200
 - Create New Enrichment Rule wizard 315
 - Rule Groups page
 - Create New Correlation Rule/Correlation Rule Properties/ Save As Correlation Rule wizard 202
 - Run Correlation dialog box 528
 - run tasks periodically
 - Scheduler 485
- ## S
- Save As Perspective wizard 148
 - Save As Template wizard 151
 - Save As View wizard 154
 - Save Reveal Path dialog box 103
 - Save Snapshot dialog box 531
 - saving to file
 - Topology Map 691
 - Scheduler
 - Action Definition dialog box 489, 508
 - define tasks to run periodically 485
 - Filter dialog box 490
 - Job Definitions dialog box 491

- Job Scheduler window 495
 - Select Days dialog box 497
 - Select Hours dialog box 497
 - Scheduler user interface 488
 - search tool
 - using 671
 - security
 - setting up 654
 - Security Manager 653
 - Security Manager overview 653
 - Security Manager user interface 654
 - Security Manager window 656
 - Select CI dialog box
 - Compare CIs 573
 - Select CIs dialog box
 - Generate Direct Link wizard 437
 - Select Command page
 - Generate Direct Link wizard 415
 - Select Days dialog box
 - Scheduler 497
 - Select Hours dialog box
 - Scheduler 497
 - Select Relationship Type dialog box 387
 - Select Valid Links 449
 - Selection Summary page
 - Create New Package/Edit Package wizard 476
 - Undeploy Package Resource wizard 482
 - Set Node Order dialog box
 - Topology Report Manager 279
 - Set Parameter Values dialog box
 - Topology report 593
 - Set Parameterized Values Summary page
 - Set Report Parameters wizard 281
 - Set Parameters on page
 - Set Report Parameters wizard 280
 - Set Report Parameter dialog box
 - Topology Report Manager 280
 - Set Report Parameters wizard
 - Set Parameterized Values Summary page 281
 - Set Parameters on page 280
 - Set View Parameters dialog box 163
 - Set View-specific Report dialog box
 - Topology Report Manager 281
 - setting parameters 158
 - snapshot comparison
 - overview 557
 - Snapshot of <View> dialog box
 - Compare Snapshots 565
 - snapshots
 - comparing 557
 - taking of view 525
 - Software Elements Search dialog box 121
 - State Manager
 - overview 499
 - State Manager dialog box 501
 - State Manager user interface 500
 - Subgraph Condition Definition dialog box 388
 - subgraph definition 328
 - Subgraph Definition dialog box 390
 - subgraph definitions
 - defining 337
 - Symmetric tab
 - Layout Properties dialog box 711
 - System Type Manager 208
 - System Type Manager dialog box 243
- T**
- template based views
 - creating 142
 - Template Properties wizard 151
 - templates
 - creating 139
 - Topology Map 67, 689
 - Main menu 713
 - overview 689
 - previewing before printing 715
 - printing and saving 526
 - saving to file 691
 - toolbar options 717
 - topology map contents
 - printing 714
 - Topology Query Language 324
 - overview 324
 - Topology Query Language (TQL) user
 - interface 352
 - Topology report
 - overview 591

Index

- Set Parameter Values dialog box 593
 - topology report
 - send at defined intervals 592
 - Topology Report Manager
 - Add Attributes dialog box 257
 - Add Function dialog box 258
 - Attribute Columns dialog box 259
 - Edit Attribute dialog box 260
 - Filter CIs dialog box 260
 - Report Node Definition dialog box 276
 - Set Node Order dialog box 279
 - Set Report Parameter dialog box 280
 - Set View-specific Report dialog box 281
 - troubleshooting and limitations 282
 - Topology Report Manager overview 246
 - Topology Report Manager user interface 256
 - Topology Report Manager window 267
 - Topology Report page 594
 - Topology reports user interface 593
 - Topology View
 - overview 516
 - Topology View Application user interface 526
 - Topology View Application window 532
 - TQL
 - audit short/detailed log 350
 - circular queries 402
 - context menu options 339
 - incremental detailed logs 352
 - incremental splitter logs 351
 - incremental statistics log 350
 - logs 348
 - pattern log 348
 - pattern statistics log 349
 - queries, circular 402
 - queries, validation restrictions 401
 - queries, visible relationships 358, 361
 - queries, visible TQL nodes 376, 398
 - self relationships 354, 361, 363, 401
 - TQL Node Properties page
 - TQL Node wizard 396
 - TQL Node wizard 392
 - Element Instances page 399
 - New TQL Node page 393
 - New TQL Relationship page 395
 - TQL Node Properties page 396
 - TQL nodes
 - visible, in TQL queries 376, 398
 - TQL query
 - define 285, 328
 - trigger node 178
 - troubleshooting and limitations
 - packages 483
 - Topology Report Manager 282
 - users and roles 648
 - View Explorer 685
 - views 175
- ## U
- UML tool
 - export to 444
 - Undeploy Package Resource wizard 481
 - Remove Resources page 481
 - Selection Summary page 482
 - undeploying packages
 - using the JMX console 467
 - Update Enumeration Definition dialog box 240
 - enumeration definition area 242
 - Update List Definition dialog box 240
 - list definition area 241
 - User Details page
 - Add New User Wizard 642
 - User Manager overview 639
 - User Manager user interface 641
 - User Name and Password page
 - Add New User Wizard 642
 - user preferences
 - defining 650
 - User Preferences dialog box 400
 - User Profile dialog box 650
 - User Profile overview 649
 - users and roles
 - troubleshooting and limitations 648
 - Users page 646

V

- validation restrictions
 - TQL queries 401
- View Base TQL 149, 152, 156
- View Editor 122
- View Explorer 669, 676
 - Browse mode 677
 - configuration 674
 - displaying a view 670
 - limitations and troubleshooting 685
 - overview 670
 - Search mode 681
 - unavailable views 685
 - using the search tool 671
- view formats 130
- View General Attributes 148, 152, 155
- View Manager
 - defining multiple relationship rules 162
 - editing pane 168
 - Node/Relationship Grouping dialog box 159
 - overview 130
 - page 164
- View Properties dialog box 126
- View Properties wizard 154
- view-based discovery 46
- views
 - based on a CI collection 96
 - based on a model 96
 - creating new CIs 37
 - creating non-related CIs 38
 - creating related CIs 38
 - displaying 670
 - factory 132
 - in IT Universe 35
 - large 690
 - lifecycle 36
 - limitations and troubleshooting 175
 - predefined 132
 - rediscovering 46
 - relationships in 41
 - tree structure 36
 - unavailable views 685
- visible node 398
- visible relationship 358, 361

W

- watchpoints 90
- Watchpoints Updates dialog box 127
- working with Topology Map 689

