

# HP Business Availability Center

for the Windows and Solaris operating systems

Software Version: 7.50

---

## Solutions and Integrations

Document Number: BACSOL7.50/01

Document Release Date: May 2008

Software Release Date: May 2008



# Legal Notices

## Warranty

The only warranties for HP products and services are set forth in the express warranty statements accompanying such products and services. Nothing herein should be construed as constituting an additional warranty. HP shall not be liable for technical or editorial errors or omissions contained herein.

The information contained herein is subject to change without notice.

## Restricted Rights Legend

Confidential computer software. Valid license from HP required for possession, use or copying. Consistent with FAR 12.211 and 12.212, Commercial Computer Software, Computer Software Documentation, and Technical Data for Commercial Items are licensed to the U.S. Government under vendor's standard commercial license.

## Third-Party Web Sites

HP provides links to external third-party Web sites to help you find supplemental information. Site content and availability may change without notice. HP makes no representations or warranties whatsoever as to site content or availability.

## Copyright Notices

© Copyright 2005 - 2008 Mercury Interactive (Israel) Ltd.

## Trademark Notices

Adobe® and Acrobat® are trademarks of Adobe Systems Incorporated.

Intel®, Pentium®, and Intel® Xeon™ are trademarks of Intel Corporation in the U.S. and other countries.

Java™ is a US trademark of Sun Microsystems, Inc.

Microsoft®, Windows®, Windows NT®, and Windows® XP are U.S registered trademarks of Microsoft Corporation.

Oracle® is a registered US trademark of Oracle Corporation, Redwood City, California.

Unix® is a registered trademark of The Open Group.

## Documentation Updates

This manual's title page contains the following identifying information:

- Software version number, which indicates the software version
- Document release date, which changes each time the document is updated
- Software release date, which indicates the release date of this version of the software

To check for recent updates, or to verify that you are using the most recent edition of a document, go to:

**<http://h20230.www2.hp.com/selfsolve/manuals>**

# Support

You can visit the HP Software Support Web site at: **[www.hp.com/go/hpsoftwaresupport](http://www.hp.com/go/hpsoftwaresupport)**

HP Software online support provides an efficient way to access interactive technical support tools. As a valued support customer, you can benefit by using the support site to:

- Search for knowledge documents of interest
- Submit and track support cases and enhancement requests
- Download software patches
- Manage support contracts
- Look up HP support contacts
- Review information about available services
- Enter into discussions with other software customers
- Research and register for software training

Most of the support areas require that you register as an HP Passport user and sign in. Many also require a support contract. To find more information about access levels, go to:

**[http://h20230.www2.hp.com/new\\_access\\_levels.jsp](http://h20230.www2.hp.com/new_access_levels.jsp)**

To register for an HP Passport ID, go to:

**<http://h20229.www2.hp.com/passport-registration.html>**

---

# Table of Contents

<b>Welcome to This Guide .....</b>	<b>11</b>
How This Guide Is Organized .....	11
Who Should Read This Guide .....	13
Getting More Information .....	13

## **PART I: HP BUSINESS AVAILABILITY CENTER FOR SOA**

<b>Chapter 1: HP Business Availability Center for SOA.....</b>	<b>17</b>
SOA Solution Overview .....	18
HP Business Availability Center for SOA Architecture.....	19
SOA Discovery and Dependency Mapping Modules .....	21
Integration of HP Diagnostics Data with SOA .....	24
Integration of HP SOA Systinet .....	26
SiteScope Monitors for SOA .....	28
SOA Views and Reports .....	29
Anti-Aging Enrichment .....	37
Monitor SOA Environment in Dashboard – Workflow .....	38
Monitor SOA Environment in Dashboard – Scenarios .....	43
Enrich the SOA Model From Scripts Defined in Monitor Administration .....	51
Deploy SiteScope SOA Monitors .....	55
Run Business Process Monitor Transactions for SOA .....	57
Customize SOA Reports.....	59
Service-Oriented Architecture User Interface .....	60
Troubleshooting and Limitations .....	110

**PART II: HP BUSINESS AVAILABILITY CENTER FOR SAP APPLICATIONS**

**Chapter 2: HP Business Availability Center for SAP Applications ... 113**  
HP Business Availability Center for SAP Applications – Overview... 114  
HP Business Availability Center for SAP Applications License ..... 115  
HP Business Availability Center for SAP Applications  
    Architecture..... 116  
Business Process Monitor Measurements in SAP Systems View  
    – Details..... 118  
SiteScope Measurements in SAP Systems View ..... 124  
SAP Systems View ..... 126  
SAP Service..... 129  
Collecting SAP System Information ..... 130  
CCMS Counters..... 131  
Deploy HP Business Availability Center for SAP Applications ..... 133  
Deploy the SAP CCMS Monitor to Retrieve Measurements  
    from the SAP System ..... 135  
Activate the SAP Service ..... 140  
Install HP Business Availability Center for SAP Applications ..... 141  
Create Monitors ..... 146  
Use a Business Process Monitor Profile to Simulate SAP Users..... 147  
Display SAP Information in Dashboard..... 154  
Default CIs in the SAP Systems View ..... 155  
SAP-Related KPIs..... 159  
SAP-Related Menu Options ..... 160  
HP Business Availability Center for SAP Applications User  
    Interface ..... 160  
Troubleshooting and Limitations ..... 172

**PART III: HP BUSINESS AVAILABILITY CENTER FOR SIEBEL APPLICATIONS**

<b>Chapter 3: HP Business Availability Center for Siebel Applications</b>	
<b>Applications</b> .....	<b>179</b>
HP Business Availability Center for Siebel Applications	
– Overview .....	180
Diagnostics Tools.....	182
License .....	186
Architecture .....	187
Working with Firewalls .....	188
Siebel Monitors.....	189
The Siebel Service .....	190
Siebel Views .....	191
Deploy HP Business Availability Center for Siebel	
Applications – Workflow .....	194
Configure HP Business Availability Center for Siebel	
Applications .....	211
Verify Diagnostics-Related Settings.....	212
Delete Links Between Siebel Applications and Business	
Process Steps.....	216
Deploy the SiteScope Siebel Monitors.....	216
Display Siebel Information in Dashboard.....	225
Create Customized Deployment Validator Tests .....	228
Customize HP Business Availability Center for Siebel	
Applications .....	230
Context Menu Options .....	232
Default CITs in the Siebel View.....	234
HP Business Availability Center for Siebel Applications	
User Interface .....	237
Troubleshooting and Limitations .....	274

**PART IV: BUSINESS AVAILABILITY CENTER APIS**

**Chapter 4: HP Business Availability Center APIs.....299**

**Chapter 5: Working with the Generic Reporting Engine API ..... 301**

Introducing the Generic Reporting Engine API..... 302

Data Returned ..... 303

Querying with a Browser..... 304

Using the Web Service..... 305

Supported SQL Syntax..... 305

Query Limitations ..... 306

Date-Time Values ..... 307

byTime Function ..... 308

Query Examples..... 309

Legacy Queries..... 310

**Chapter 6: Working with the HP Universal CMDB API ..... 325**

Conventions ..... 326

Using the HP Universal CMDB API..... 327

HP UCMDB API Reference ..... 328

Call the Web Service ..... 329

Create Queries to Return Unambiguous TopologyMap Elements.... 329

Query the HP UCMDB Module..... 333

Update the HP UCMDB Module ..... 350

Query the HP UCMDB Module Class Model ..... 355

Query for Impact Analysis..... 357

Use Cases ..... 360

Examples..... 361

UCMDB General Parameters ..... 388

UCMDB Output Parameters ..... 392

**Chapter 7: Working with the Dashboard API..... 395**

Building Queries..... 395

Query Examples..... 398



**PART V: EMS INTEGRATIONS**

<b>Chapter 8: Enterprise Management Systems Integration</b> .....	<b>401</b>
Enterprise Management Systems and the EMS Integrations	
Application Overview .....	402
Understanding the Application<-->Host or Host Integration	
Adapters .....	403
Reconciliation of Hosts .....	405
Integrate Data from Third-Party Sources (EMS Data) into	
HP Business Availability Center.....	407
EMS User Interface .....	414
<b>Chapter 9: HP OVO Integration</b> .....	<b>425</b>
Understanding the HP OVO Integration .....	425
Use the EMS Integration Tool for HP OVO Server Events .....	429
<b>Chapter 10: Configure HP ServiceCenter for Integration with</b>	
<b>HP Business Availability Center</b> .....	<b>435</b>
Configure HP ServiceCenter.....	435
Before you Upgrade HP ServiceCenter From Previous Versions .....	449
<b>Chapter 11: HP ServiceCenter Integration</b> .....	<b>451</b>
Understanding the HP ServiceCenter Integration .....	451
Use the EMS Integration Tool for HP ServiceCenter Data .....	456
<b>Chapter 12: NetScout nGenius Integration</b> .....	<b>461</b>
NetScout Integration Overview .....	461
Use the EMS Integration Tool for NetScout Data .....	463

**PART VI: DIAGNOSTICS INTEGRATION**

<b>Chapter 13: HP Diagnostics and HP Business Availability</b>	
<b>Center Integration</b> .....	<b>469</b>
HP Diagnostics and HP Business Availability Center	
Integration Overview .....	470
Access Online Help for HP Diagnostics in HP Business	
Availability Center .....	470
View HP Diagnostics Data in HP Business Availability Center.....	471
Troubleshooting and Limitations .....	472

**PART VII: APPLICATION PERFORMANCE LIFECYCLE**

**Chapter 14: Application Performance Lifecycle .....475**  
Application Performance Lifecycle Overview .....476  
Application Performance Lifecycle Reports .....476  
Application Performance Lifecycle Workflow .....480  
Analyze the Business Process Distribution Report .....481  
Replay a Session.....484  
Generate a Script Template .....485  
Analyze a Typical Transaction Load Report.....486  
Analyze the Location Load Analysis Report.....488  
Use Application Performance Lifecycle Reports – A Case  
Scenario.....489  
Refine Your Script Template in VuGen.....492  
Configure and Run a Load Test.....496  
Work with the Central Repository Service (CRS).....501  
Application Performance Lifecycle User Interface .....505

**Chapter 15: Business Process Recognition .....521**  
Business Process Recognition Application – Overview .....521  
Business Process Recognition Architecture .....523  
Convert Real User Monitor Data into Business Process  
Recognition Data .....524  
Deploy Business Process Recognition and Analyze the Results.....525  
Customize Business Process Recognition.....527  
Business Process Recognition User Interface.....528

**Index.....547**

---

# Welcome to This Guide

This guide describes various solutions and integrations available for HP Business Availability Center.

**This chapter includes:**

- ▶ How This Guide Is Organized on page 11
- ▶ Who Should Read This Guide on page 13
- ▶ Getting More Information on page 13

## How This Guide Is Organized

The guide contains the following parts:

**Part I HP Business Availability Center for SOA**

Describes the tasks to perform in HP Business Availability Center to monitor your Service-Oriented Architecture (SOA) enterprise environment.

**Part II HP Business Availability Center for SAP Applications**

Describes how to install the SAP solution, the specific tasks involved in administering it, how the SAP discovery job discovers SAP-related CIs and general CIs (such as hosts) that are related to them, and provides information that can help troubleshooting the HP Business Availability Center SAP solution.

### **Part III HP Business Availability Center for Siebel Applications**

Describes how to administer Business Availability Center for Siebel Applications solution, the specific tasks involved in administering it, how the Siebel discovery job discovers Siebel-related CIs and general CIs that are related to them, and provide information that can help troubleshooting Business Availability Center for Siebel Applications solution.

### **Part IV Business Availability Center APIs**

Describes how to use the HP Business Availability Center generic data engine API to extract data from HP Business Availability Center for use with third-party or custom tools, as well as how to use the CMDB API to read/write data from/to the CMDB and the Dashboard API to retrieve information about one or more views in an HP Business Availability Center system through a URL-based query to the database.

### **Part V EMS Integrations**

Describes how to build new integrations or customize out-of-the-box integrations for EMS (Enterprise Management Systems) applications, and how to integrate HP OVO data, HP ServiceCenter data, and NetScout nGenius data into HP Business Availability Center.

### **Part VI Diagnostics Integration**

Describes how to configure the integration between HP Diagnostics and HP Business Availability Center.

### **Part VII Application Performance Lifecycle**

Describes how to use the Application Performance Lifecycle to integrate between HP Business Availability Center and HP Performance Center, enabling you to construct load tests based on real-user transaction data collected by the Real User Monitor, and how to use the Business Process Recognition tool to discover business processes that can help you monitor what really matters.

## Who Should Read This Guide

This guide is intended for the following users of HP Business Availability Center:

- HP Business Availability Center administrators
- HP Business Availability Center platform administrators
- HP Business Availability Center application administrators
- HP Business Availability Center data collector administrators
- HP Business Availability Center end users

Readers of this guide should be knowledgeable about navigating and using enterprise applications, and be familiar with HP Business Availability Center and enterprise monitoring and management concepts.

## Getting More Information

For a complete list of all online documentation included with HP Business Availability Center, additional online resources, information on acquiring documentation updates, and typographical conventions used in this guide, see the the *HP Business Availability Center Deployment Guide* PDF.

Welcome to This Guide

# Part I

---

## HP Business Availability Center for SOA





# 1

---

## HP Business Availability Center for SOA

This chapter describes Business Availability Center for SOA.

### **This chapter includes:**

#### **Concepts**

- ▶ SOA Solution Overview on page 18
- ▶ HP Business Availability Center for SOA Architecture on page 19
- ▶ SOA Discovery and Dependency Mapping Modules on page 21
- ▶ Integration of HP Diagnostics Data with SOA on page 24
- ▶ Integration of HP SOA Systinet on page 26
- ▶ SiteScope Monitors for SOA on page 28
- ▶ SOA Views and Reports on page 29
- ▶ Anti-Aging Enrichment on page 37

#### **Tasks**

- ▶ Monitor SOA Environment in Dashboard – Workflow on page 38
- ▶ Monitor SOA Environment in Dashboard – Scenarios on page 43
- ▶ Enrich the SOA Model From Scripts Defined in Monitor Administration on page 51
- ▶ Deploy SiteScope SOA Monitors on page 55
- ▶ Run Business Process Monitor Transactions for SOA on page 57
- ▶ Customize SOA Reports on page 59

#### **Reference**

- ▶ Service-Oriented Architecture User Interface on page 60

**Troubleshooting and Limitations** on page 110

## **SOA Solution Overview**

HP Business Availability Center enables you to monitor your SOA environment, by monitoring the performance of SOA components within the environment. The data is collected by different HP Business Availability Center components:

- ▶ Discovery and Dependency Mapping jobs identify and map the SOA-based applications in your system from the UDDI registry, and from the Web services deployed onto IBM WebSphere, BEA WebLogic, Oracle Application Server, and IIS containers. For more information, see “SOA Discovery and Dependency Mapping Modules” on page 21.
- ▶ Dedicated SiteScope monitors collect Web service metrics and UDDI server health data. For more information, see “SiteScope Monitors for SOA” on page 28.

SiteScope data is displayed in the SOA reports and in the SOA views.

- ▶ Business Process Monitors collect Web service performance data using Business Process Monitor transactions that run Web services scripts. For more information, see “Run Business Process Monitor Transactions for SOA” on page 57.
- ▶ Diagnostics probes collect Web service performance and availability metrics directly on the Web server machines. For more information, see “Integration of HP Diagnostics Data with SOA” on page 24.

Diagnostics data is displayed in the SOA reports and in the SOA views.

Business Process Monitor and SiteScope are used for synthetic monitoring of Web services while Diagnostics is used for real monitoring of Web services calls.

The collected data is used to build the SOA views and reports available from **Applications > Business Availability Center for SOA**. For details, see “SOA Views and Reports” on page 29.

You can create SLAs centered around your HP Business Availability Center for SOA Web Services CIs to gain visibility into performance or availability issues that affect these SLAs. For details about SLAs, see “Service Level Management - Overview” in *Using Service Level Management*.

CIs that originate from Systinet (they represent HP SOA Systinet Web Services) can also be added to SLAs. For details about Systinet CIs, see “Integration with HP SOA Systinet” in *Using Service Level Management*. You can drill down to HP SOA Systinet during agreement creation or editing to view contract information for Web services in HP SOA Systinet. For details about the drill down, see “Systinet Web Service Data” in *Using Dashboard*.

## HP Business Availability Center for SOA Architecture

The following illustration shows the components of the HP Business Availability Center for SOA:

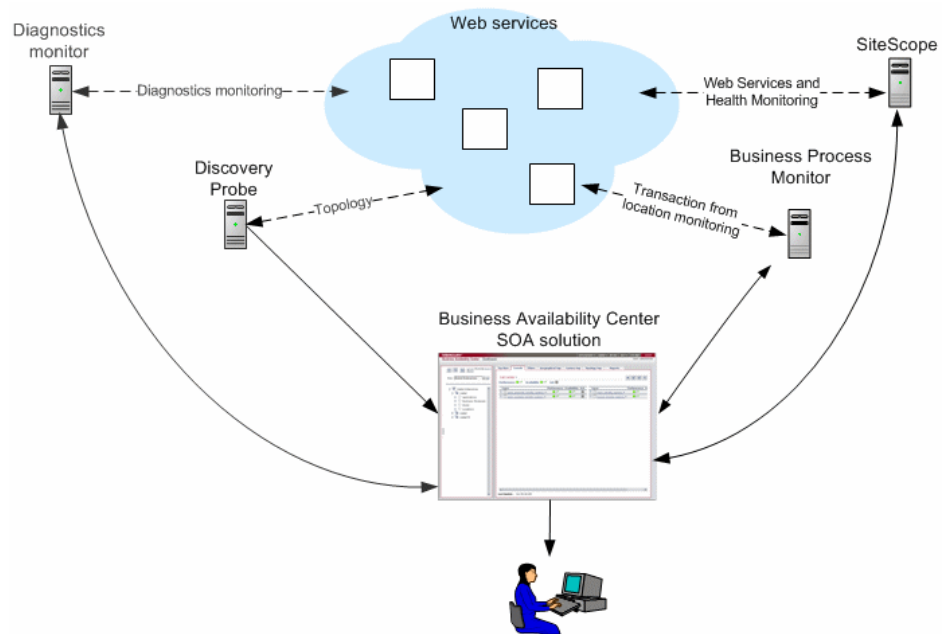

All monitors create their own topology in the CMDB. In addition to the user transactions, Business Process Monitor also sends topology data and SOA samples (events and performance) to the CMDB. Automatic discovery adds more information about the SOA CIs and their relationships in the CMDB.

The architecture of the HP Business Availability Center for SOA solution includes the following components:

- ▶ The DDM Probe communicates with HP Universal CMDB. In such a case, HP Universal CMDB and HP Business Availability Center use the same CMDB. HP Universal CMDB server collects information on changes made to a CI's properties (changes of the SOA infrastructure: hosts, application servers, and so on) and functional changes of the Web services (changes to WSDL; for example if a new parameter or a new operation was added or if an operation was removed). This information is stored in the History database, and is available in the SOA-related views in HP Business Availability Center. For details about the History database, see the *HP Business Availability Center Database Guide* PDF. For details about the change feature, see "View Changes Made to SOA CIs" on page 43.

The discovery jobs are used by the DDM Probe to discover, identify, and map the SOA-based applications in your system, starting from the UDDI registry, and from Web services deployed onto IBM Websphere, BEA WebLogic, Oracle Application Server, and IIS (Internet Information Services). This information is then used to create SOA-related CIs and other CIs in the CMDB. It also creates the hierarchy of CIs displayed in the SOA UDDI Registry, the SOA Web Services, the SOA Rogue Services, and other views. A rogue service is a service which is not registered in the UDDI registry.

- ▶ Business Process Monitor collects data on the performance and availability of the Web services by running transactions that run Web services scripts. The CIs and relationships for the incoming Business Process Monitor samples are created by the Business Process Monitoring source adapter (described in "Business Process Monitoring Source Adapter Details" in *Model Management*). For details about the samples, see "Data Samples for Business Process Monitor" in *Reference Information*.

- ▶ The Diagnostics Monitor monitors real user traffic to the Web services and operations and sends the information to the Diagnostics server. The Diagnostics server sends, using SDK, the topology to the CMDB and the samples to HP Business Availability Center. Depending on the incoming Diagnostics samples, the appropriate KPIs and rules are assigned to the CIs by the SOA KPI Assignment group. Diagnostics data is available in the SOA reports when you select the **Real Data** parameter. For details, see each report description in “Service-Oriented Architecture User Interface” on page 60.
- ▶ SiteScope monitors the Web services and retrieves Web services metrics and UDDI server health data. When working with SiteScope 9.50, the CIs and relationships for the incoming SiteScope samples are created by the SiteScope KPI Assignments (described in “SiteScope KPI Assignment Group Overview” in *Using Dashboard*). SiteScope data is available in the SOA reports when you select the **Synthetic** parameter. For details, see each report description.
- ▶ Dashboard tabs and reports are used as the central console for viewing all of the data and performing analysis of the data. For details, see “Introduction to Dashboard” in *Using Dashboard*.

## SOA Discovery and Dependency Mapping Modules

HP Business Availability Center includes discovery patterns for monitoring your SOA environment.

The Discovery and Dependency Mapping modules (containing discovery jobs/patterns), listed in this section, are involved in discovering the Web services and WSDL files that relate to your SOA infrastructure. When a module is run, it creates CIs for the discovered elements in the CMDB. The appropriate HP Business Availability Center views are automatically populated with the created CIs, according to the TQL for each view.

---

**Note:** HP Business Availability Center supports nested WSDL files (mapped to Configuration File CIs). A WSDL file contains several sections that can be mapped to different Configuration File CIs. For example the service operations can be mapped to one CI and the service binding information to a different CI. This practice enables sharing similar definitions across Web services.

---

The modules are listed in the following table:

Module (A - Z)	Description
Application - Webservices Module	<p>The module contains the UDDI Registry pattern and is mainly responsible for mapping the service providers, Web services, and WSDL files that are discovered from the UDDI registry (for UDDI versions 2 and 3). This information is presented in the SOA UDDI view.</p> <p>For information on the Application - Webservices module, see “Universal Description Discovery and Integration (UDDI) Discovery” in <i>Discovery and Dependency Mapping Guide</i>.</p> <p>For details about the SOA UDDI view, see “SOA Views and Reports” on page 29.</p> <p><b>Note:</b> WSDL files should be placed in the UDDI registry according to the following UDDI hierarchy (from the UDDI technical specification by OASIS): <b>BusinessService &gt; TemplateBinding &gt; TModel &gt; OverViewDoc</b>. They cannot be found in any other location.</p>

Module (A - Z)	Description
J2EE - WebLogic module	<p>The module discovers Web services and their WSDL files, deployed onto BEA WebLogic servers. The resulting CIs for the Web services, Web service operations, and configuration files are presented in the WebLogic Topology view (along with other components discovered on the WebLogic servers) and added to the SOA Web Services view and SOA UDDI view, as relevant.</p> <p>For information on the J2EE - WebLogic module, see “WebLogic Discovery” in <i>Discovery and Dependency Mapping Guide</i>.</p> <p>For details about the SOA UDDI and SOA Web Services views, see “SOA Views in Dashboard” on page 29.</p>
J2EE - WebSphere module	<p>The module discovers WSDL files deployed onto IBM WebSphere servers, and parses the WSDL to identify the Web service components. The resulting CIs for the Web services, Web service operations, and configuration files are presented in the WebSphere Topology view (along with other components discovered on the WebSphere servers) and added to the SOA Web Services view and SOA UDDI view, as relevant.</p> <p>For information on the J2EE - WebSphere module, see “WebSphere Discovery” in <i>Discovery and Dependency Mapping Guide</i>.</p> <p>For details about the SOA UDDI and SOA Web Services views, see “SOA Views in Dashboard” on page 29.</p>
Oracle Application Server module	<p>The module discovers the Oracle E-Business Suite.</p>

Module (A - Z)	Description
Web Servers - IIS module	<p>The module discovers Web services and their WSDL files deployed onto Microsoft IIS servers. The discovery process creates CIs for the discovered Web services, Web service operations, and configuration (WSDL) files. These CIs are added to the SOA Web Services view and SOA UDDI view, as relevant, and the Web service CIs are presented in the IIS Topology view (along with other components discovered on the IIS servers).</p> <p>For information on the Web Servers - IIS module, see “Internet Information Services (IIS) Discovery” in <i>Discovery and Dependency Mapping Guide</i>.</p> <p>For details about the SOA UDDI and SOA Web Services views, see “SOA Views in Dashboard” on page 29.</p>

## Integration of HP Diagnostics Data with SOA

HP Business Availability Center with HP Diagnostics, enables you to view end-to-end performance information in HP Business Availability Center applications, for Web services that are monitored by HP Diagnostics. You can also directly access the HP Diagnostics application to view Web services reports.

The Web service information is collected by HP Diagnostics probes installed on the Web Server machine. The probes detect Web service traffic on the machine and identify Web service operations for the Web services. Part of the monitoring data, collected for each Web service operation, is stored in HP Diagnostics, the rest of the data is stored in HP Business Availability Center.

HP Diagnostics sends the topology of Web services, which includes the Web service, its operations and also the monitors, to the CMDB, but does not send the WSDL files. The SOA KPI Assignment group assigns the KPIs and rules appropriate for each CI in the topology depending on the samples received by HP Business Availability Center.



The key attributes of a Web service are its target name space and service name. (For information on the view, see “SOA Views in Dashboard” on page 29.)

For information on deploying the HP Diagnostics probes, and accessing the HP Diagnostics application from HP Business Availability Center, see the *HP Diagnostics User's Guide* (accessible from the HP Business Availability Center Help menu after registering the HP Diagnostics server).

---

**Note:** HP Diagnostics monitoring is supported for Web services based on SOAP over HTTP/S protocols.

---

## Availability Calculation

The availability of a Web service/operation is calculated using the **error\_count** field of the SOA Performance sample. Depending on the data source, the availability errors may include SOAP faults. The data sources fill in the **error\_count** field according to the following table:

Data Source (Types of Samples)	Error_count Field (part of the SOA Performance sample)		
	SOAP Services		REST Web Services
	SOAP Faults	HTTP Errors	
Business Process Monitor (performance and error samples)	ALL All errors generated by the Business Process Monitor are real errors.	ALL Reported as an error in the Performance sample.	None
SiteScope (performance sample)	ALL All errors generated by the SiteScope scripts are real errors.	ALL Reported as an error in the Performance sample.	None

Data Source (Types of Samples)	Error_count Field (part of the SOA Performance sample)		
	SOAP Services		REST Web Services
	SOAP Faults	HTTP Errors	
Diagnostics (performance, event, and error samples)	<p>Only configured SOAP faults</p> <p>The <b>Receiver</b> SOAP faults is considered as an error by default. The <b>VersionMismatch</b>, <b>MustUnderstand</b>, <b>DataEncoding</b>, and <b>UnknownSender</b> SOAP faults are not considered as errors for the Performance sample but are sent as events in the event sample.</p> <p>The payload capture information is stored only in Diagnostics.</p>	<p>None</p> <p>Diagnostics does not have the ability to recognize HTTP errors.</p>	<p>HTTP status code 5xx-6ss are considered as server side errors and are reported in <b>error_count</b> towards availability calculation</p>

## Integration of HP SOA Systinet

HP Business Availability Center supports integration with the HP SOA Systinet platform, enabling you to better manage and monitor your business services, and to understand the business impact of Web services. The integration also enables you to streamline the contracts information defined in HP SOA Systinet with your SLAs in HP Business Availability Center.

For details on enabling the integration, see “Enable HP SOA Systinet Integration” on page 40.

The integration with HP SOA Systinet provides the capabilities described in the following sections:

- ▶ **HP SOA Systinet service model is available in HP Business Availability Center**

You can run the discovery UDDI registry pattern to discover the content of your HP SOA Systinet Registry, so that the HP SOA Systinet service model is available in HP Business Availability Center. For details, see “Universal Description Discovery and Integration (UDDI) Discovery” in *Discovery and Dependency Mapping Guide*.

- **You can use the links available in Dashboard, Service Level Management and HP Business Availability Center for SOA, to open HP SOA Systinet directly at the page for the selected Web service**

HP SOA Systinet provides information on the Web service, such as the contracts on the service, policies and their compliancy, usage plans, and other general information. This can be useful for problem isolation and understanding the business impact.

When defining an SLA in Service Level Management, you can use the link to HP SOA Systinet to view the contract information in HP SOA Systinet and then configure the SLA accordingly in HP Business Availability Center. For details on the link, see “Integration with HP SOA Systinet” in *Using Service Level Management*.

In Dashboard, you can link to HP SOA Systinet to open the page for the selected Web service. For details on the link, see “Go to Report” in *Using Dashboard*.

- **In HP SOA Systinet, you can view service performance status (availability, performance, and so on) derived from HP Business Availability Center**

You can also link to the health report in HP Business Availability Center for the selected service. This information can help consumers understand and evaluate service status.

For information on HP SOA Systinet, including service contracts and how to view service performance status derived from HP Business Availability Center, see the HP SOA Systinet documentation.

## SiteScope Monitors for SOA

You deploy dedicated SiteScope monitors to collect Web service metrics and UDDI server health data. The collected data is used to calculate KPI values in the SOA views, and can be viewed in reports of the HP Business Availability Center for SOA application.

SiteScope monitors for SOA monitoring can be deployed from the Monitor Deployment Wizard, or from System Availability Management.

The SiteScope monitors used to monitor your SOA environment are:

- ▶ **UDDI Monitor.** Used to perform a search in the UDDI Server. Each time that the monitor is run, SiteScope checks if the UDDI Server can find a business entity. For details, see “UDDI Monitor Overview” in *Using System Availability Management*.
- ▶ **Web Service Monitor.** Used to check the availability of a Web service accepting Simple Object Access Protocol (SOAP) requests. The Web Service Monitor checks that the service can send a response to the client in a certain amount of time and verifies that the SOAP response is correct based on match specifications. For details, see “Web Service Monitor Overview” in *Using System Availability Management*.
- ▶ **Technology Web Service Integration Monitor.** Used to integrate Web service event data or metrics data from an existing EMS system to HP Business Availability Center. This monitor can only be deployed from System Availability Management, not from the Monitor Deployment Wizard. For details, see “Technology Web Service Integration Monitor Overview” in *Using System Availability Management*.

## SOA Views and Reports

The SOA views present Web services performance, availability, and throughput (load on the Web service) information collected by SiteScope, Business Process Monitor, and Diagnostics monitors, about monitoring traffic to selected Web services, operations, endpoints, or servers. The data enables you to analyze the detected performance issues, and helps you to identify the cause of delays. In addition, the views display information about the system status impacting the Web service as well as change information.

If the Web service is discovered on an application server (WebLogic, WebSphere, Oracle Application Server, or IIS) the Web service has a relationship with its host (the host is a child of the Web service; if you monitor the host CPU for example, it has a System KPI that propagates to the Web service). This helps to triage Web service problems, when the Web service has a performance/availability problem due to a system issue.

This section includes the following topics:

- “SOA Views in Dashboard” on page 29
- “SOA Topology Discovered by SiteScope” on page 33
- “Accessing Other Information” on page 33
- “CIs Discovered by the Discovery Process” on page 34
- “HP Business Availability Center for SOA Reports” on page 35

### **SOA Views in Dashboard**

HP Business Availability Center for SOA displays information about the performance, availability, and throughput of the UDDI registry, Web services, operations, SiteScope monitors, SiteScope Web services monitors, and nested WSDL in the following views:

► **SOA Monitored Web Services View**

Includes all of the web services that were discovered by Discovery and Dependency Mapping or created by SiteScope, Business Process Monitor or HP Diagnostics, and stored in the CMDB and that are currently monitored.

The TQL for the view is built as follows:

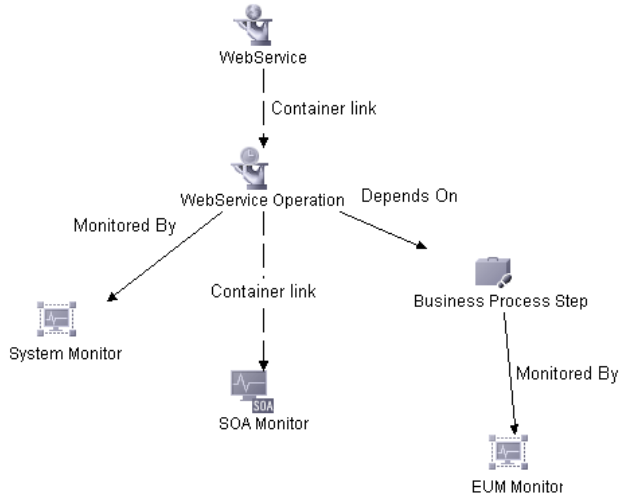

► **SOA Web Service View**

Includes all of the web services that were discovered and stored in the CMDB.

The TQL for the view is built as follows:

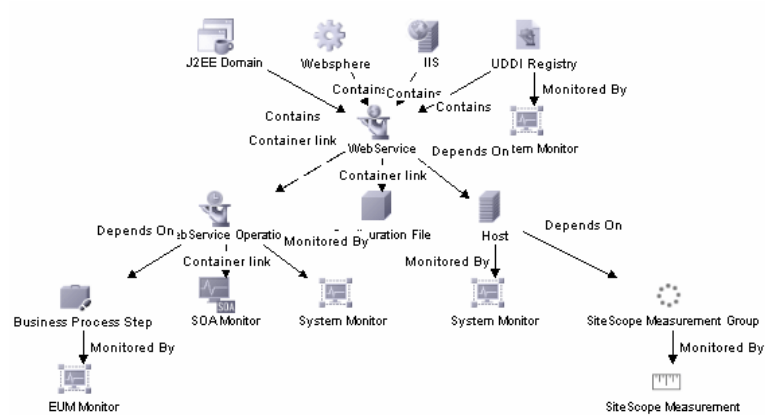

► **SOA Rogue Services View**

Includes all of the web services that were discovered and stored in the CMDB and that are not registered in the UDDI registry. They also appear in the SOA Web Services View.

The TQL for the view is built as follows:

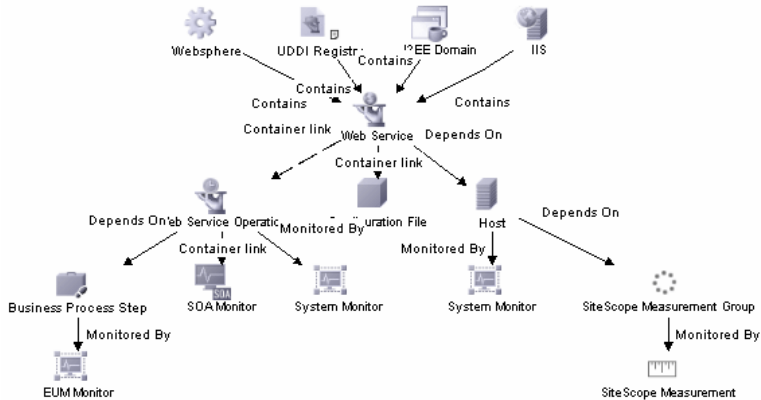

► **The SOA UDDI View**

The SOA UDDI view represents information obtained by running the UDDI discovery. The SOA UDDI view includes the UDDI registries and all the Web services that were discovered from the UDDI registries. It also includes their operations and WSDL. The Web service providers (represented by the business unit) are also discovered and related to their respective Web services. The business unit level represents the service provider.

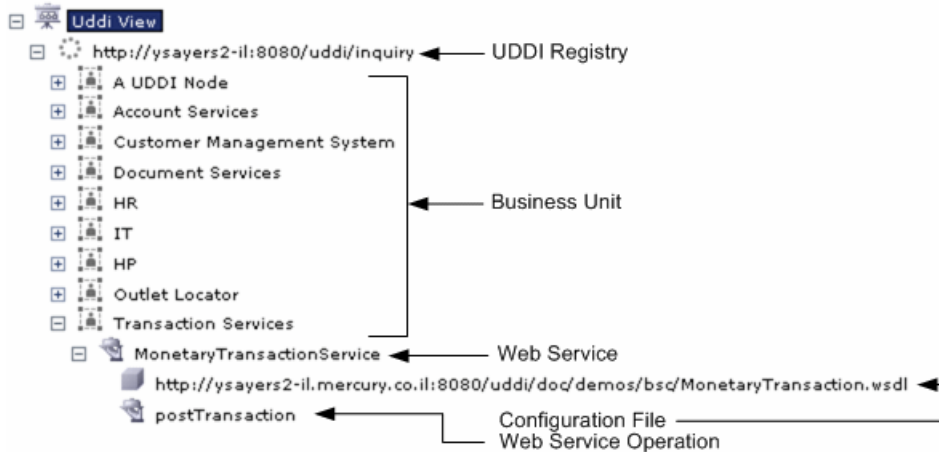

**Note:** Nested WSDL files are mapped to the Configuration File CIs. For details, see “View Configuration File CI Details” on page 42.

The TQL for the view is built as follows:

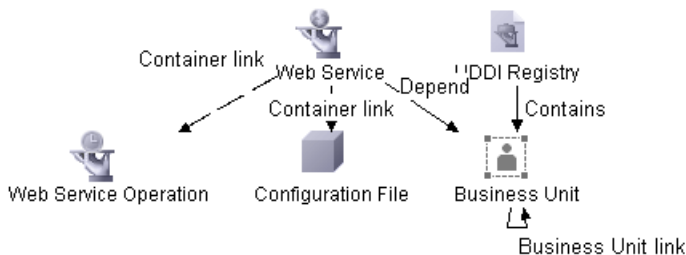



## SOA Topology Discovered by SiteScope

In addition, the SOA UDDI view includes the following topology, which is created for the SiteScope Web Service monitor. The CIs are created only for the monitored entities according to the counters that you selected.

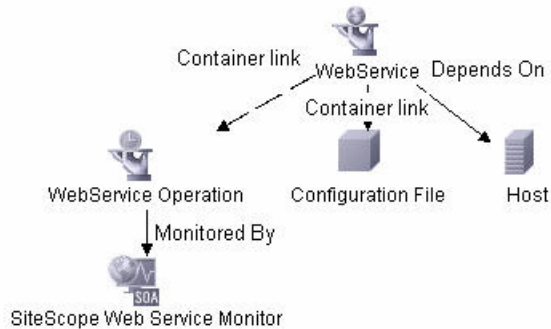

---

**Note:** The SiteScope Web Service Monitor CI replaces the legacy SiteScope Monitor CI for the Web Service monitor instances when upgrading from previous versions of SiteScope to SiteScope 9.50. During the upgrade, the SiteScope Monitor CI is removed from the CMDB, which causes it to also be removed automatically from instance views that included it or from SLAs to which it was attached.

---

## Accessing Other Information

From the SOA views you can:

- Drill down to the HP Business Availability Center for SOA reports that present detailed metrics information about the performance, availability, and throughput over time, as well as the total number of calls, the number of calls that are slow or end with a SOAP fault, the least available Web services/operations, the slowest Web services/operations, consumer information, and server information, and so on.
- Use the context menu to access additional information; for example to access the HP Diagnostics application. For details, see “Menu Options” in *Using Dashboard*.







- ▶ Access User reports. User reports provide a list of all of the defined custom reports, trend reports, and custom links that have been defined in the system, that the current user has permissions to view. You can display the reports in Excel format, create custom reports, and trend reports, and so on. For details, see “Report Manager Overview” in *Reports*.

## CI s Discovered by the Discovery Process

The following CI s are discovered by the SOA discovery processes. For details, see “SOA Discovery and Dependency Mapping Modules” on page 21.

The default KPI s are described in “List of Dashboard KPI s and Their Details” in *CI Attribute Customization*.

The CI s discovered by the discovery process are:

CI Name	Icon	Description
UDDI Registry		The UDDI Registry CI represents all of the UDDI registries that were discovered in your network.
Business Unit		The Business Unit CI represents the service providers discovered in your network.
Web Service Monitor		The Web Service Monitor CI represents the Web services monitors discovered in your network.
Web Services		The Web Services CI represents the Web services discovered in your network.
Web Service Operation		The Web Service Operation CI s represent the operations discovered in your network.
Configuration File		The Configuration File CI s represent the URL of the WSDL page used by the Web service.

## HP Business Availability Center for SOA Reports

The HP Business Availability Center for SOA reports enable you to proactively monitor the availability, response time, throughput, number of calls, number of SOAP faults, and number of slow calls, to selected Web services or operations, by selected consumer or server.

You use the SOA reports to view and analyze the health of access to Web services or operations.

For details on working with HP Business Availability Center reports, see “Reports User Interface” in *Reports*.

This section includes the following topics:

- “Report Access and Permissions” on page 35
- “Business Availability Center for SOA Reports” on page 36
- “Data Aggregation” on page 36

### Report Access and Permissions

The availability of report data for a specific user is dependent on the profile access permissions granted that user. Furthermore, access to specific data within a profile can also be limited by the administrator using report filters. For details on granting permissions, see “Permissions Tab” in *Platform Administration*.

For details on setting report filters, see “Profile Entity Maintenance Overview” in *Platform Administration* and “Active Filter Dialog Box” on page 61.

In addition, the SOA reports permissions is based on the views permissions. An SOA report (except for the Top Metrics Report) is dependent on the selected view. You are able to display only views for which you have permission.

Only views that are assigned to SOA are available in the SOA reports. A view can be assigned to SOA in the view properties. For details, see “Create New View/View Properties Dialog Box” in *Model Management*.

## **Business Availability Center for SOA Reports**

The Business Availability Center for SOA tab includes the following reports:

- ▶ **Health report.** Displays health metrics for the selected Web services, operations, consumers, or endpoints in a selected view. For details, see “Health Report” on page 71.
- ▶ **Top Metrics report.** Displays the top metrics information about the traffic to and from all of the monitored Web services or operations. For details, see “Top Metrics Report” on page 97.
- ▶ **Metrics Over Time report.** Displays the performance, over time, measuring access to selected Web services or operations, by an endpoint, or a consumer. For details, see “Metrics Over Time Report” on page 85.
- ▶ **Consumer Summary report.** Displays specific metrics for all of the consumers accessing the selected Web services or operations in a selected view. For details, see “Consumer Summary Report” on page 65.
- ▶ **Server and Endpoint Summary report.** Displays a drillable summary of the metrics for all of the servers on which the selected Web services or operations of a selected view are running. For details, see “Server and Endpoint Summary Report” on page 90.

The data displayed in some of the reports is obtained from the Diagnostics, or SiteScope monitors.

## **Data Aggregation**

HP Business Availability Center uses data aggregation to make data handling and management more efficient and to improve the speed and performance of report generation. For more information on data aggregation in HP Business Availability Center, see “Data Aggregation” in *Reference Information*.

## Anti-Aging Enrichment

When you run a Web services script, the script checks the CMDB for the Web service CIs mentioned in the script. If the CI already exists, the script adds the Business Process Monitor CI subtree to the Web Service CI -> Operations CI topology. If the CI does not exist, the Business Process Monitor creates the **Web Service CI -> Operations CI -> Business Process Monitor CI** topology.

The BPM\_WS\_ANTI\_AGING anti-aging TQL is run periodically in the CMDB. It searches for the **Web Service CI -> Operations CI -> Business Process Monitor CI** graph. When it encounters the graph, it automatically postpones the deletion of those CIs.

When you erase the script from Monitor Administration, the Business Process Monitor CI is erased from the CMDB, the **Web Service CI -> Operations CI** topology becomes incomplete and is therefore automatically deleted by the aging mechanism.

## Monitor SOA Environment in Dashboard – Workflow

This section describes the processes to monitor an SOA environment in Dashboard, and gives examples.

---

**Note:**

- ▶ If you want to discover all the Web Services attached to your network, or if you are working with a large amount of Web Services, you must use Discovery and Dependency Mapping to discover the SOA architecture on your network.
  - ▶ If you want to Monitor Web Services without discovering them first or if you know the Web Services WSDL files, you do not need to perform Discovery and Dependency Mapping as the SiteScope and Business Process Monitor monitors are able to build the CI topology and to transfer data directly from the WSDL files.
  - ▶ Diagnostics analyzes the calls and detects the Web Services, and uses that knowledge to build the CI topology and to transfer data to HP Business Availability Center.
- 

This task includes the following steps:

- ▶ “Valid License” on page 39
- ▶ “Perform Discovery and Dependency Mapping – Optional” on page 39
- ▶ “Enable HP Diagnostics Integration and Deploy Diagnostics Probes” on page 39
- ▶ “Enable HP SOA Systinet Integration” on page 40
- ▶ “Deploy SiteScope Monitors” on page 40
- ▶ “Create Business Process Profiles” on page 40
- ▶ “Customize How you Monitor SOA in Dashboard” on page 41
- ▶ “Enrich the SOA Model From Scripts Defined in Monitor Administration” on page 41
- ▶ “Customize SOA Reports” on page 41

- “View SOA Information in Dashboard” on page 41
- “View Configuration File CI Details” on page 42
- “View Changes Made to SOA CIs” on page 43

## 1 Valid License

To view the HP Business Availability Center for SOA application, you must have an HP Business Availability Center for SOA license. For details, see “License Management Overview” in *Platform Administration*.

## 2 Perform Discovery and Dependency Mapping – Optional

You can deploy the appropriate discovery patterns to discover the SOA architecture on your network. HP Business Availability Center includes discovery patterns for monitoring your SOA environment. The discovery patterns are deployed from **Admin > Universal CMDB > Discovery > Job Configuration**.

- **UDDI Monitor.** Used to discover Web Services in the UDDI Server. Each time that the monitor is run, SiteScope checks if the UDDI Server can find a Web Service. For details, see “UDDI Monitor Overview” in *Using System Availability Management*.
- **Application Server.** Discover Web Services running on application servers instances (IIS, Weblogic and others).

For information on deploying and running discovery, see “Package Administration Overview” in *Model Management* and “Discovery and Dependency Mapping – Overview” in *Discovery and Dependency Mapping Guide*.

For information on the SOA discovery modules, see “SOA Discovery and Dependency Mapping Modules” on page 21.

## 3 Enable HP Diagnostics Integration and Deploy Diagnostics Probes

To view metrics collected by HP Diagnostics probes installed on the Web server machines, register the Diagnostics server in HP Business Availability Center. For details, see “HP Diagnostics and HP Business Availability Center Integration” on page 469.

**Note:** HP Diagnostics monitoring is supported for Web services based on SOAP over HTTP/S protocols.

---

#### **4 Enable HP SOA Systinet Integration**

If you are running HP SOA Systinet, you can integrate it with HP Business Availability Center to enable more unified management and monitoring of your business services, and to understand the business impact of Web services. The integration also enables you to streamline the contracts information defined in HP SOA Systinet with your SLAs in HP Business Availability Center.

To enable the HP SOA Systinet and HP Business Availability Center integration, you must register the HP SOA Systinet server in HP Business Availability Center. Select **Admin > Platform > Setup and Maintenance > Infrastructure Settings**, choose **Applications**, select **BAC for SOA**, and locate the **Systinet server host and port** entry in the **BAC for SOA - Systinet Settings** table. Define the host name and port, if required.

#### **5 Deploy SiteScope Monitors**

If you want dedicated SiteScope monitors to provide metrics on your SOA components, you must deploy the monitors. For details, see “Deploy SiteScope SOA Monitors” on page 55.

#### **6 Create Business Process Profiles**

If you want your SOA views to include performance metrics for running transactions on your Web servers, you must define the Business Process profiles and transactions. For details, see “Run Business Process Monitor Transactions for SOA” on page 57.



## **7 Customize How you Monitor SOA in Dashboard**

You can customize the KPI assignment groups that attach to pre-defined CIs, KPIs, rules, tooltips, context menus, and context menu items, under specified conditions. You can modify the following KPI assignment groups:

- ▶ The Business Process Monitor KPI assignment group and the Diagnostics KPI assignment group. For details, see “SOA KPI Assignment Group Details” in *Using Dashboard*.
- ▶ The SiteScope KPI assignment groups. For details, see “SiteScope KPI Assignment Group Overview” in *Using Dashboard*.

## **8 Enrich the SOA Model From Scripts Defined in Monitor Administration**

If required, you can enrich the SOA model using scripts that define Web Services. Those scripts are created in Virtual User Generator and run in Monitor Administration. For details, see “Enrich the SOA Model From Scripts Defined in Monitor Administration” on page 51.

## **9 Customize SOA Reports**

You can customize SOA reports. For details, see “Customize SOA Reports” on page 59.

## **10 View SOA Information in Dashboard**

Once your SOA monitoring environment is set up, you can view SOA monitoring data in Dashboard, Service Level Management, and the HP Business Availability Center for SOA application using views and reports. For details, see “SOA Views and Reports” on page 29.

## 11 View Configuration File CI Details

Right-click a Configuration File CI in the SOA UDDI View, select **Properties**, and click **Show document content** to display the contents of the configuration file that displays the contents of the WSDL page corresponding to the URL. For details, see “Properties Dialog Box” in *Model Management*.

---

**Note:** Nested WSDL files are mapped to the Configuration File CIs.

---

### Example

```
<?xml version="1.0" encoding="UTF-8"?>
<!-- edited with XMLSpy v2005 U (http://www.xmlspy.com) by mrkef (mrkef) -->
<wsdl:definitions xmlns:impl="http://company.com/accountsvc/account"
xmlns:intf="http://company.com/accountsvc/account" xmlns:wSDL="http://schemas.xmlsoap.org/wsdl/"
xmlns:wSDLsoap="http://schemas.xmlsoap.org/wsdl/soap/"
xmlns:wSD="http://www.w3.org/2001/XMLSchema" xmlns:http="http://schemas.xmlsoap.org/wsdl/http/"
xmlns:mime="http://schemas.xmlsoap.org/wsdl/mime/"
targetNamespace="http://company.com/accountsvc/account">
  <wsdl:types>
    <schema elementFormDefault="qualified"
targetNamespace="http://company.com/accountsvc/account"
xmlns="http://www.w3.org/2001/XMLSchema">
      <element name="getAccount">
        <complexType>
          <sequence/>
        </complexType>
      </element>
      <element name="getAccountResponse">
        <complexType>
          <sequence/>
        </complexType>
      </element>
    </schema>
  </wsdl:types>
</wsdl:definitions>
```

Nested WSDL appear in View Explorer as a list of Configuration File CIs under the main Configuration File CI. For example:

```
http://<server_name>/uddi/doc/wsdl/account.wsdl
http://<server_name>/uddi/doc/wsdl/account_binding.wsdl
http://<server_name>/uddi/doc/wsdl/account_portType.wsdl
```

## 12 View Changes Made to SOA CIs

Changes made to the properties of all types of CIs (changes of the SOA infrastructure: hosts, application servers, and so on) and functional changes of the web services (changes to WSDL; for example if a new parameter or a new operation were added or if an operation was removed) are discovered by different types of discoveries. Those changes are displayed in the Change report available as a context menu option for each one of the relevant CI types.

For details about the Change report, see “Change Report Page” in *Model Management*.

For details about the UDDI Registry, WebSphere, WebLogic, and IIS discoveries, see “Discovery and Dependency Mapping Content” in *Discovery and Dependency Mapping Guide*.

## Monitor SOA Environment in Dashboard – Scenarios

This section provides scenarios that show how you can use the Business Availability Center for SOA reports to find the source of problems.

This section includes the following topics:

- ▶ “Availability Problem – Scenario” on page 43
- ▶ “Performance Problem – Scenario” on page 46
- ▶ “Throughput Problem – Scenario” on page 49

### Availability Problem – Scenario

The Dashboard Console page displays, in the SOA Web Services view, a service availability problem. There is no problem with the system. The problem seems to be with the MedRecWebServices web service.

You want to drill down to the SOA Health report to understand where the problem is located. Click the down arrow to the right of the CI and select **Go to Report > Web Services Health**.

The Health Report displays the health of the operations.

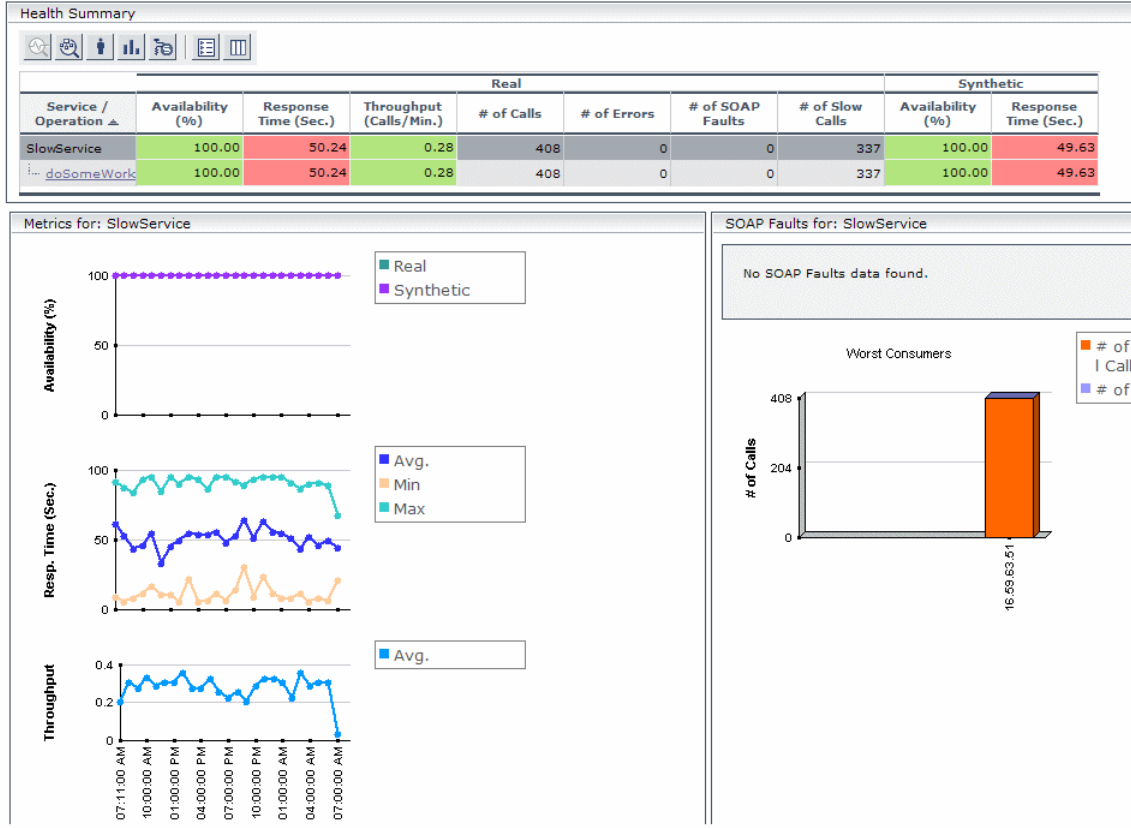



A suspect operation is found. Select the appropriate operation and click the button to access Diagnostics for the selected operation.

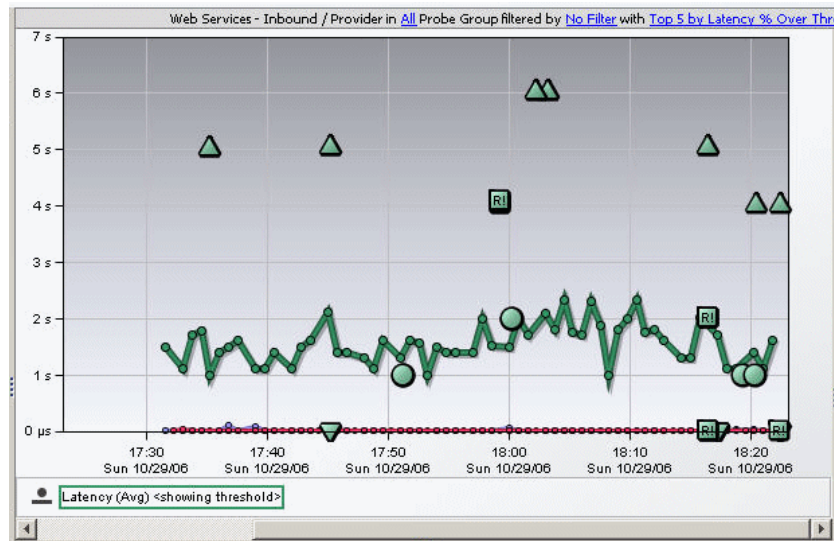

Diagnostics displays the SOAP fault that caused the problem.

Call Profile [Receiver SOAP Fault Instance of SimpleWebService::startCallChain ending at 10/29/06 5:59:10 PM for Default]

Call Profile **SOAP Fault**

**Code:**  
Receiver

**Reason:**  
Exception during processing: java.lang.ArrayIndexOutOfBoundsException (see Fault Detail for stacktrace)

**Detail:**

```
java.lang.ArrayIndexOutOfBoundsException
    at SimpleWebService.CallNextMethod(SimpleWebService.java:365)
    at SimpleWebService.CallNextMethod(SimpleWebService.java:405)
    at SimpleWebService.CallChain(SimpleWebService.java:414)
    at SimpleWebService.startCallChain(SimpleWebService.java:422)
    at jrockit.reflect.VirtualNativeMethodInvoker.invoke(Ljava.lang.Object;[Ljava.lang.Object;)Ljava.lang.Object;(Unknown Source)
    at java.lang.reflect.Method.invoke(Ljava.lang.Object;[Ljava.lang.Object;)Ljava.lang.Object;(Unknown Source)
    at weblogic.webservice.component.javaclass.JavaClassInvocationHandler.invoke(JavaClassInvocationHandler.java:134)
    at weblogic.webservice.core.handler.InvokeHandler.handleRequest(InvokeHandler.java:105)
    at weblogic.webservice.core.HandlerChainImpl.handleRequest(HandlerChainImpl.java:144)
    at weblogic.webservice.core.DefaultOperation.process(DefaultOperation.java:551)
    at weblogic.webservice.server.Dispatcher.process(Dispatcher.java:204)
    at weblogic.webservice.server.Dispatcher.doDispatch(Dispatcher.java:175)
```

You can view the SOAP fault information to find the root cause of the problem. For details, see HP Diagnostics documentation.

## Performance Problem – Scenario

The Dashboard Console page displays, in the SOA Web Services view, a service performance problem. There is no problem with the system. The problem seems to be with the SlowService web service.

To drill down to the SOA Health report, click the down arrow to the right of the CI in the Console page, and select **Go to Report > Web Services Health**.

The Health Report opens.

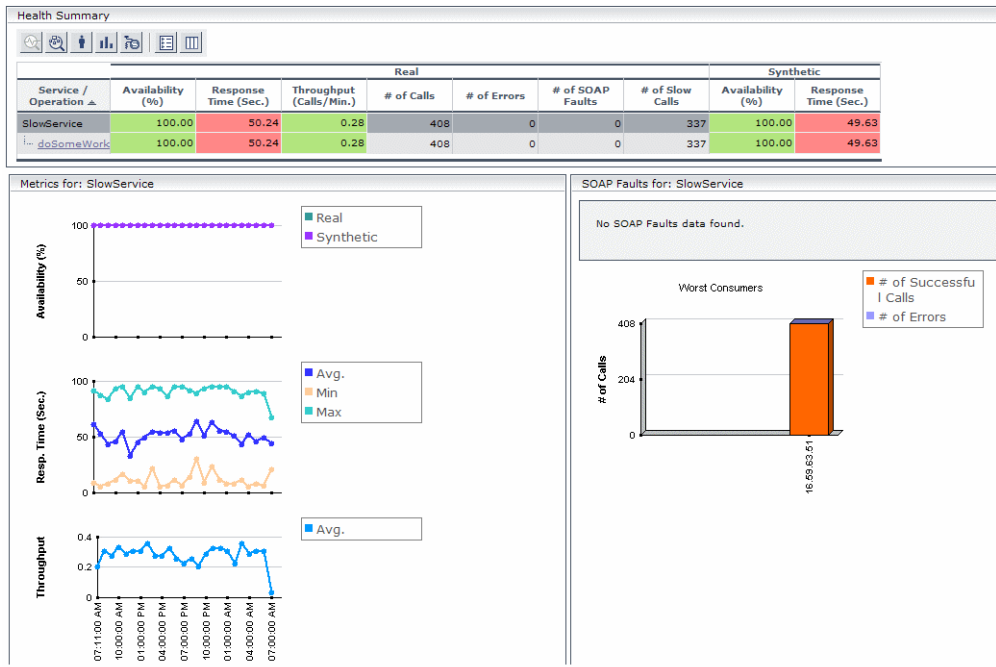

A suspect operation is found. Click the appropriate operation.

The Health report for the relevant operation opens. Scroll down and view the graphs.

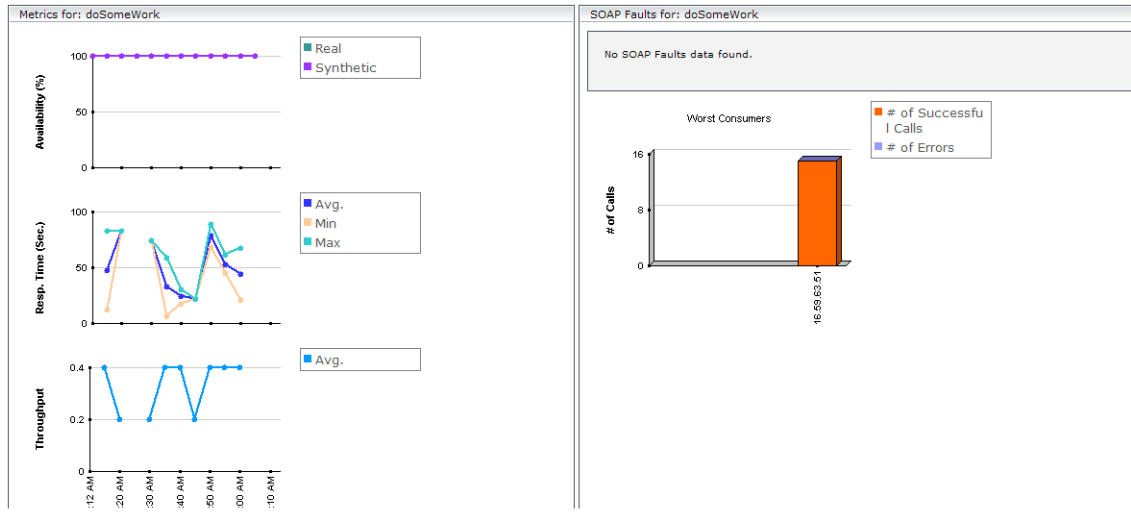

The **Throughput** graph does not indicate service overload.



Select the operation and click the **Drill down to Diagnostics Operations View** button to drill down to Diagnostics.

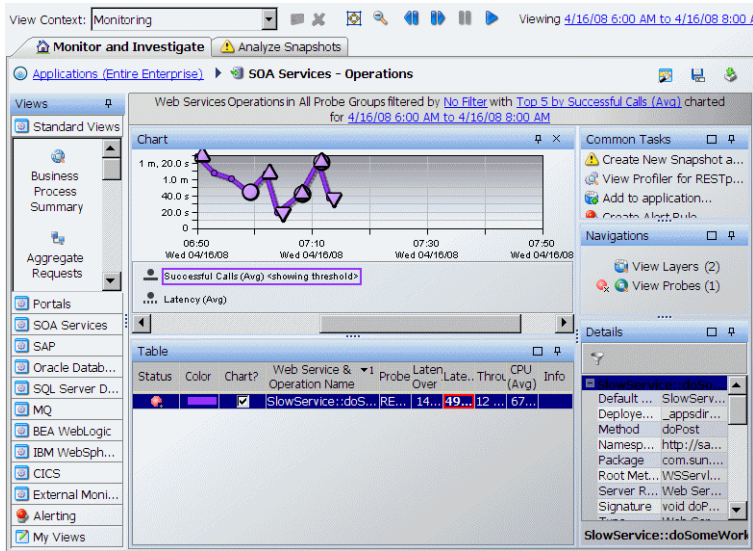

In Diagnostics, you can drill down from each instance to its call profile.

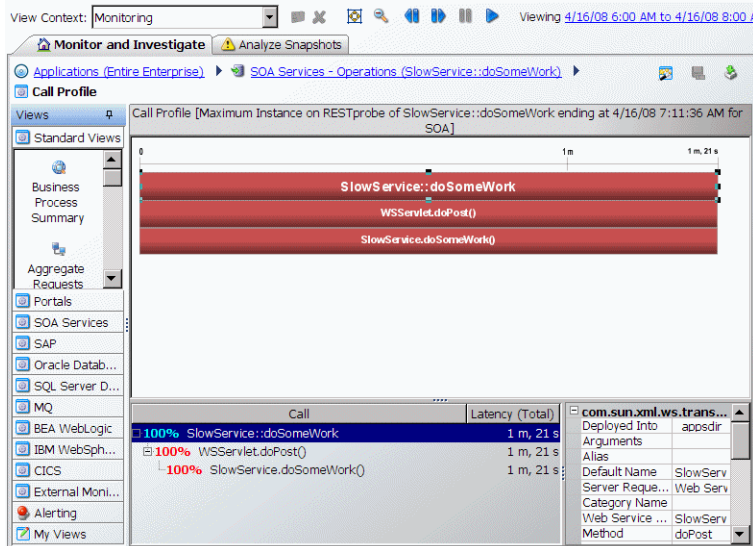



You can then view the layers breakdown of the Web Service operations and find out how much time was spent in each layer (Web Service, database, and so on). For details, see HP Diagnostics documentation.

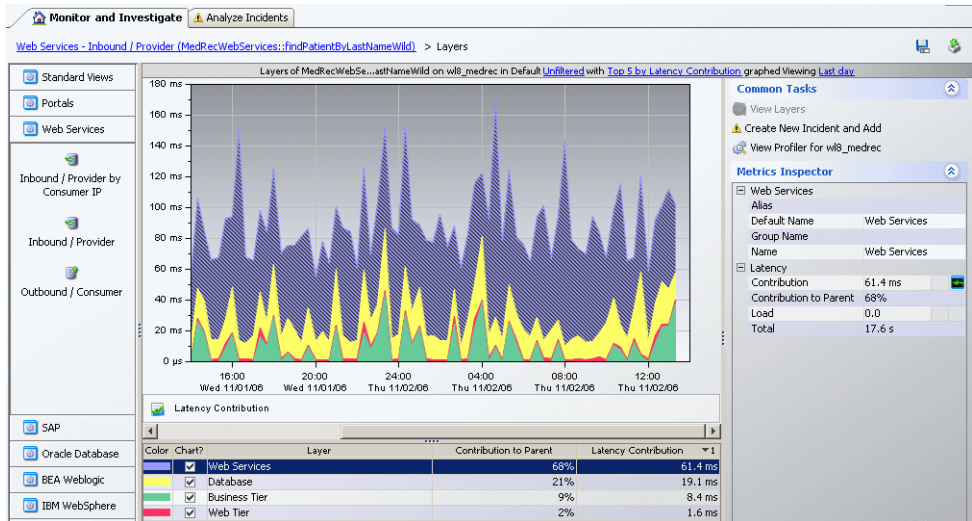

## Throughput Problem – Scenario

The Dashboard Console page displays, in the SOA Web Services view, a service performance problem. There is no problem with the system. The problem seems to be with the MedRecWebServices web service.

To drill down to the SOA Health report, click the down arrow to the right of the CI in the Console page, and select **Go to Report > Web Services Health**.

A problematic operation (addRecord) is found. Both the response time and throughput of the operation indicate a problem. A suspected reason for the problem would be an overloaded service. You can view the correlation between the response time and the throughput in the Metrics section.

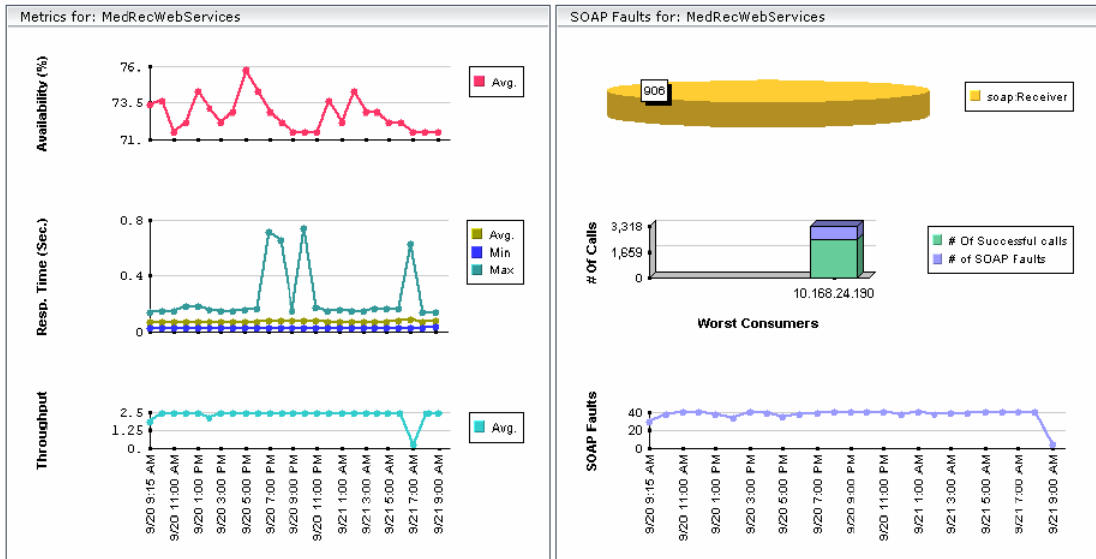

After you assess that the reason is a throughput problem, you can drill down and find the consumers that overload the service.

## Enrich the SOA Model From Scripts Defined in Monitor Administration

Enrich the SOA model with scripts to create a relationship between Host CIs and Web Service CIs, and to view status changes for the Web Service CI when the status of the Host CI monitored by SiteScope changes.

This feature is supported for Virtual User Generator/Service Test 9.10, LoadRunner 9.10, and Business Process Monitor 7.50.

Business Process Monitor sends SOA data via HTTP, using the BAC API. Web Data Entry (WDE) converts the data into two UDX samples: SOA Performance and SOA Event (errors are reported in this sample). The samples are sent according to the schedule.

When Business Process Monitor sends samples, the data is displayed in the HP Business Availability Center for SOA Application under the **Synthetic** data type.

---

### Limitations:

- ▶ To be supported, a Web Service script must have a WSDL version 1.1, and the WSDL file, which describes the Web Service and the Web Service operations, supplied with the script should use WSDL version 1.1.
  - ▶ REST Web Services can be monitored by Business Process Monitor, but SOA data reporting is not supported (they do not have a WSDL file); only regular errors are reported. SOAP\_request calls are not supported as they do not have WSDL.
  - ▶ Virtual User Generator/LoadRunner do not support WebServices protocols on Unix.
  - ▶ Drilldown operations are not supported between SOA and End User Management reports.
-

This task includes the following steps:

- “Record a Script in Virtual User Generator” on page 52
- “Add the Web Service Script to Monitor Administration” on page 53
- “Run the Web Service Script” on page 53

## 1 Record a Script in Virtual User Generator

You can define Web Services inside scripts in Virtual User Generator/Service Test 9.10 or LoadRunner 9.10. You can record Web Service calls with different operations. Each operation call is then reported as a different transaction. For details about defining scripts in Virtual User Generator, see Virtual User Generator documentation.

A Web Service script does not need to include user transactions to produce data. If more than one script uses the same CI, a single CI is created. A CI is deleted if none of the scripts uses it.

For each SOA script, Virtual User Generator creates a file. The file is used by the End User Management administrator to add the relevant SOA CIs to the model (Web Service, Operation, and Monitor CIs). The file is generated or updated after each save/update operation is done using Virtual User Generator/Service Test. The file is included in the runtime files used for exporting to a zip file using Virtual User Generator.

---

**Note:** If you are using legacy scripts recorded with Virtual User Generator up to version 9.0, data reporting is supported by Business Process Monitor, but the SOA CIs must be added to the model. To add the SOA CIs, download the script from CRS, open the script in Virtual User Generator 9.10 once and save the script (the script is saved to the new format), upload the new script version in CRS, and reload script version in End User Management for relevant monitors.

---

For each web service call, the following line is added to the file, regardless of the status of the web service call:

```
<operation_name>; <web_service_name>; <target_namespace>;  
<wsdl_name/location>
```

where `<wsdl_name/location>` is required to locate the relevant WSDL if there is more than one WSDL.

An operation called more than once in the script is represented by one line in the file. The order of the operations in the script is not important.

WSDL files should be imported into the script.

If you override manually the endpoint (name of port) address in Virtual User Generator, the new address is reported to Business Process Monitor.

Business Process Monitor ignores the **Define each step as a transaction** option in Virtual User Generator settings.

The WSDL file and the Operations file are zipped together with other script files.

If more than one WSDL file is created for one Web Service script (set of hierarchic WSDL files), Virtual User Generator places them in one folder.

## 2 Add the Web Service Script to Monitor Administration

To add the Web Service script to Monitor Administration, upload it to the Central Repository Service (CRS), and assign it to a specific Business Process Monitor profile and host with a specific scheduling. For details about CRS, see “Central Repository Service - Overview” in *Platform Administration*.

## 3 Run the Web Service Script

If you have set the SOA license, you are running the script in Virtual User Generator, and the operations file appears in the script, the **Enable SOA breakdown** option is automatically enabled in Monitor Administration, and the SOA Performance and SOA Events samples from the operation are reported to HP Business Availability Center.

Business Process Monitor sets the **Define each step as a transaction option = true** when the script is a Web Service script.

Business Process Monitor plays the script and reports SOA samples by wrapping each operation call within an automatic transaction. The automatic transaction is provided by LoadRunner. The automatic transactions are not displayed in Monitor Administration and are not counted in the licensed number of transactions for Business Process Monitor.

Business Process Monitor can distinguish between SOA faults and other faults (HTTP or other).

If the operation already exists (added to the CMDB by Discovery and Dependency Mapping), the SOA KPI assignment group uses the existing operations CIs. The SOA Monitor CI and the BPM Web Service Monitor CIs, as well as their performance and the event, are displayed in the SOA UDDI view in Dashboard.

When you attach a Web Service script to a profile, a CI is created. The CI status is changed to **No data** when the profile is stopped, when you do not attach it to a monitor, or if the script is old.

The following topology is created in the CMDB: **Web Service CI** -> **Operations CI** -> **Business Process Monitor CI**. The topology is maintained by the anti-aging enrichment mechanism. For details, see “Anti-Aging Enrichment” on page 37.

**BPM for SOA** CIs are included in the model only when the CMDB includes the following information:

- ▶ **WS name**, **OP name**, and **target name space** CIs exist and the **enable field** value is **true** for these CIs.
- ▶ Each operation (add/remove/update script, version/change check box) in Monitor Administration updates this information.

## Deploy SiteScope SOA Monitors

---

**Note:** Perform this task only when working with SiteScope 9.0.

---

You deploy dedicated SiteScope monitors to collect Web service metrics and UDDI server health data. The collected data is used to calculate KPI values in the SOA views, and can be viewed in reports of the HP Business Availability Center for SOA application.

SiteScope monitors for SOA monitoring can be deployed from the Monitor Deployment Wizard, or from System Availability Management.

This task includes the following steps:

- ▶ “Use the Monitor Deployment Wizard” on page 55
- ▶ “Manually Attach SiteScope Monitors” on page 57

### **1 Use the Monitor Deployment Wizard**

You can create and map SiteScope monitors directly onto the SOA CIs created by the discovery process, using the Monitor Deployment Wizard. The SiteScope monitoring CIs generated by the SiteScope monitors are then deployed onto the UDDI Registry and Web Service Operation CIs, creating a **Monitored By** relationship between them. For details, see “Monitor Deployment Wizard” in *Using System Availability Management*.

#### **Example**

- a** Proceed as explained in “Monitor Deployment Wizard” in *Using System Availability Management*.
- b** In the left pane of the Select Configuration Items to Monitor page, select the relevant SOA view. Select the CIs you would like monitored and move them to the right pane.

---

**Note:** You can map Web service operations to Web Service Monitors and UDDI Registry CIs to the UDDI Registry Monitors.

---

If the Web Service Operation CIs that you move to the right pane are already monitored, then they are displayed in italics with an **Already monitored** message.

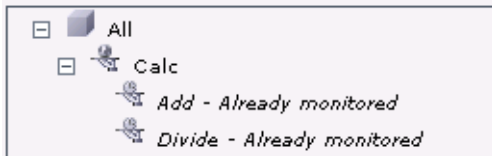

- c** Click **Next**. The Select Templates to Apply page opens. The left pane lists all the available templates in the wizard, including the Web Services Monitors and UDDI Monitors templates used for the SOA monitors, and the SiteScope templates for host if the hosts on which the Web services are deployed are also selected. Expand the template to see the monitors that are deployed by the template. The right pane lists the CI types (CITs) for the CIs selected in the previous page of the wizard.

If you added Web Service Operation CIs to the right pane at the previous stage of the wizard, then the wizard automatically matches them with the Web Services Monitors template, and displays the Web Service Operation CIT in the right pane with the template attached.

- d** Proceed with the wizard as indicated in “Monitor Deployment Wizard” in *Using System Availability Management*.

The added Web Service Monitor CIs are given default names as follows:  
Synthetic Monitor On <name of relevant Web Service Operation CI>



## 2 Manually Attach SiteScope Monitors

If the monitors are deployed from System Availability Management, you must manually attach them to SOA discovery CIs. This is done in **Admin > Universal CMDB > Modeling > IT Universe Manager**. For details, see “Working with CIs” in *Model Management*.

For details about the SiteScope monitors used to monitor your SOA environment, see “SiteScope Monitors for SOA” on page 28.

## Run Business Process Monitor Transactions for SOA

You can deploy Business Process profiles containing transaction monitors to actively monitor Web service performance. The transaction monitors run scripts that emulate Web service requests from end users, supplying end-to-end availability and response time metrics from varied and remote locations. The metrics are used for the BPM Transaction from Location CIs that are created in the CMDB.

You map the created business process monitoring CIs to the SOA CIs created by the discovery process, to produce an integrated SOA Web Services view.

---

**Note:** Business process monitoring data is not available in the HP Business Availability Center for SOA application.

---

This task includes the following steps:

- “Create Scripts in HP Virtual User Generator” on page 58
- “Define Business Process Profiles” on page 58
- “View Business Process Monitoring CIs in the Views” on page 58

## 1 Create Scripts in HP Virtual User Generator

Create scripts in HP Virtual User Generator that emulate the Web service requests. For details, see *HP Virtual User Generator User's Guide*.

## 2 Define Business Process Profiles

Use the following steps:

- a** Define Business Process profiles in **Admin > System Availability Management**, using the Business Process Profile Wizard.
- b** Add to the profiles, the relevant transaction monitors that run the HP Virtual User Generator scripts for Web service requests.
- c** Assign the profiles to Business Process Monitor machines/instances at the required locations.

For details, see “Creating Business Process Profiles and Monitors Overview” in *Using End User Management*.

## 3 View Business Process Monitoring CIs in the Views

To see the business process monitoring CIs immediately in the views, synchronize the Business Process Monitoring source adapter in the **Admin > Universal CMDB > Source Manager** page. (Alternatively, wait for the automatic synchronization to take place.)

---

**Note:** To include location information in the business process monitoring CI hierarchy, set the Business Process Monitoring source adapter to use the **Transaction/Location** hierarchy structure. For more information, see “Business Process Monitoring Source Adapter Details” in *Model Management*.

---

Once Business Process Monitor has run the scripts, the resulting BPM Transaction from Location CIs are added to the CMDB and displayed in the monitors views and the End Users views. For information on the hierarchy of these views, see “Business Process Monitoring Source Adapter Details” in *Model Management*.

To map the SOA CIs in the SOA Web Services view (discovered during the discovery process) to the relevant Business Process Step CIs and BPM Transaction from Location CIs, you must manually attach the business process monitoring CIs to the higher level CIs. This is done in **Admin > Universal CMDB > Modeling > IT Universe Manager**. For details, see “Attaching Existing CIs” in *Model Management*.

## Customize SOA Reports

You can customize SOA reports.

---

**Note:** All the steps in the task are optional and can be performed in any order.

---

This task includes the following steps:

- “Customize the Number of Web Services or Operations Displayed in the SOA Reports” on page 59
- “Customize the Number of Elements Displayed in the Top Metrics Reports” on page 60

### **1 Customize the Number of Web Services or Operations Displayed in the SOA Reports**

You can customize the number of Web services or operations that can be displayed in an SOA report. The default value is 20.

To customize the number of Web services or operations that can be displayed in an SOA report, access the **Admin > Platform > Setup and Maintenance > Infrastructure Settings** page, click choose **Applications**, select **BAC for SOA**, locate the **BAC for SOA - General Settings** table, and set the required value of the **Max. number of selectable CIs in SOA reports** parameter.

## 2 Customize the Number of Elements Displayed in the Top Metrics Reports

You can customize the number of elements that can be displayed in a Top Metrics report. The default value is 5.

To customize the number of elements that can be displayed in a Top Metrics report, access the **Admin > Platform > Setup and Maintenance > Infrastructure Settings** page, click choose **Applications**, select **BAC for SOA**, locate the **BAC for SOA - General Settings** table, and set the required value of the **Top Metrics Size** parameter.

## Service-Oriented Architecture User Interface

### **This section describes:**

- Active Filter Dialog Box on page 61
- Consumer Summary Report on page 65
- Health Report on page 71
- Metrics Over Time Report on page 85
- Server and Endpoint Summary Report on page 90
- Top Metrics Report on page 97

## Active Filter Dialog Box

<b>Description</b>	<p>Enables you to filter SOA reports. The Active Filter includes the following tabs:</p> <ul style="list-style-type: none"> <li>▶ Web Services/Operations</li> <li>▶ Metrics when you access the dialog box from the Metrics Over Time report.</li> <li>▶ Endpoint/Consumers</li> <li>▶ Views when you access the dialog box from the Top Metrics report. The dialog box displays the Views that you allowed to see.</li> </ul> <p><b>To Access:</b> In the Health, Top Metrics, Metrics Over Time, Consumer Summary, or Server and Endpoint Summary reports, click <b>Active Filters</b>.</p>
<b>Important Information</b>	You can also select items from both tabs to create more complex filters.

### Web Service/Operations Tab

The following elements are included (unlabeled GUI elements are shown in angle brackets>):

GUI Element (A-Z)	Description
<b>Number of Selected Operations</b>	Indicates the number of Operation CIs that you have selected.
<b>Number of Selected Web Services</b>	Indicates the number of Web Service CI that you have selected.
<b>Search</b>	Click to search for a specific CI in the current view or in all views. For details, see “Search for CIs in Search Mode” in <i>Model Management</i> .

GUI Element (A-Z)	Description
<b>Selected CIs</b>	<p>Select one of the following:</p> <ul style="list-style-type: none"> <li>▶ <b>Web Services.</b> Displays a check box only for the Web services CIs appearing in the view.</li> <li>▶ <b>Operations.</b> Displays a check box only for the operation CIs appearing in the view.</li> </ul> <p>You can select up to 20 Web services or operations. This number can be modified in the Infrastructure Settings. For details, see “Customize the Number of Web Services or Operations Displayed in the SOA Reports” on page 59.</p>
<b>View</b>	<p>Select the appropriate view and select the relevant CIs in the view. Only views for which the user has permission and that have been assigned to SOA are displayed in the list. For additional information on the available views, see “SOA Views in Dashboard” on page 29.</p>

### Metrics Tab

<b>Important Information</b>	The Metrics tab is displayed when you click <b>Active Filter</b> in the Metrics Over Time report.
------------------------------	---

The following elements are included (unlabeled GUI elements are shown in angle brackets):

GUI Element (A-Z)	Description
<Metrics>	Select the metrics you want to display in the report.

## Endpoint/Consumer Tab

The following elements are included (unlabeled GUI elements are shown in angle brackets>):

GUI Element (A-Z)	Description
Consumer	<p>You can:</p> <ul style="list-style-type: none"> <li>▶ Filter by consumer information, for consumers registered in HP Diagnostics, by entering one of the following:               <ul style="list-style-type: none"> <li>▶ The consumer ID (it can be an IP address, IP range, HTTP header, or payload in SOAP requests).</li> <li>▶ The consumer subunit name, which is the name of the IP range where the customer is located.</li> <li>▶ The consumer details taken from the payload; for example Web Service http custom header value or Web service SOAP payload value (soap-header/soap-envelope/soap-body).</li> </ul> </li> </ul> <p>The consumer information can be any string, up to 100 characters, including wildcards.</p> <p><b>Note:</b> For performance reasons, the wildcard can only be located on the right most side on the string.</p> <p>For details, see <i>HP Diagnostics Installation and Configuration Guide</i>.</p> <ul style="list-style-type: none"> <li>▶ Enter <b>Other</b> to search for all non-registered consumers that access the server or endpoint listed in the Server IP or End Point box.</li> </ul>

GUI Element (A-Z)	Description
<b>Endpoint</b>	<p>Enter the monitored endpoint. The value depends on the data source.</p> <p>For HP Diagnostics, it is the application server instance name (defined in HP Diagnostics).</p> <p>For Business Process Monitor and SiteScope, it is the port name/endpoint (depending on the WSDL version) that the user select from the WSDL when creating the script/monitor.</p>
<b>Server IP</b>	<p>Enter the server IP number to display information about the consumers accessing specific servers.</p> <p>You can also use a wildcard (*) as the end of the string.</p>

## Views

The following elements are included (unlabeled GUI elements are shown in angle brackets):

GUI Element (A-Z)	Description
<Views>	<p>Select a view.</p> <p>The View box lists the views you are allowed to display.</p> <p>This dialog box is displayed when you click <b>Active Filters</b> in the Top Metrics report.</p>



## Consumer Summary Report

<b>Description</b>	<p>Displays specific metrics for all of the consumers accessing the selected Web services or operations in a selected view.</p> <p><b>To Access:</b> Select <b>Application &gt; Business Availability Center for SOA</b>, click the <b>Business Availability Center for SOA</b> tab, and select the <b>Consumer Summary Report</b> option in the Business Availability Center for SOA tab.</p>
<b>Important Information</b>	<p>When you select <b>Real</b>, the Consumer Summary Report displays information only for the consumers that were registered in the Diagnostics system. All other consumers are aggregated and presented as <b>Others</b>.</p> <p><b>Note:</b> You can add this report as a portlet in My BAC. For details, see “Add Portlets to &lt;page_name&gt;/Add Portlets Dialog Box” in <i>Using My BAC</i>.</p>
<b>Included in Tasks</b>	“Monitor SOA Environment in Dashboard – Workflow” on page 38

### Report Settings

GUI Element (A-Z)	Description
<Common report settings>	For details, see “Common Report Elements” in <i>Reports</i> .
<b>Active Filter</b>	If relevant, click to select the appropriate conditions for the report. For details, see “Active Filter Dialog Box” on page 61.
<b>Real/Synthetic</b>	<p>Select one of the following:</p> <ul style="list-style-type: none"> <li>▶ <b>Real.</b> To display data from the Diagnostics data collector.</li> <li>▶ <b>Synthetic.</b> To display data from the SiteScope and Business Process monitors.</li> </ul> <p><b>Note:</b> When you generate an SOA report, the <b>Data Type</b> selection is displayed in the top part of the report.</p>

## Consumer Summary Area

Consumer Summary							
Consumer ▲	Availability (%)	Response Time (Sec.)	Throughput	# of Calls	# of Errors	# of SOAP Faults	# of Slow Calls
16.59.44.183	60.00	0.04	236.12	340,013	136,004	136,004	0
Other	59.96	0.07	2.21	3,177	1,272	1,272	0

<b>Description</b>	Displays the health metrics for all of the consumers accessing the selected Web services or operations. If, in the Active Filters, you also select specific consumer, endpoint or server, the health metrics are further filtered by these selections.
<b>Important Information</b>	The Consumer Summary area is the same in the View as Graph and View as Table tabs.
<b>Useful Links</b>	“Availability Calculation” on page 25

The following elements are included (unlabeled GUI elements are shown in angle brackets>):

GUI Element (A-Z)	Description
	Click to drill down to the Health Report for the selected element. For details, see “Health Report” on page 71.
<b># of Calls</b>	The total number of calls accessed by the specific consumer.
<b># of Errors</b>	The total number of failed calls by the specific consumer. A failed call is a call that was not performed due to the unavailability of the Web services or operations. <b>Configurable:</b> The SOAP faults affecting the availability can be configured in HP Diagnostics when the call is monitored by HP Diagnostics.

GUI Element (A-Z)	Description
# of Slow Calls	<p>The number of slow calls by the specific consumer. A slow call is a call with a response time longer than the predefined threshold.</p> <p><b>Note:</b> The value displayed by # of Slow Calls is different from the value of the <b>Total Threshold Violation</b> in HP Diagnostics. In HP Diagnostics the <b>Total Threshold Violation</b> includes the overall number of violation from all the calls and in HP Business Availability Center # of <b>Slow Calls</b> includes only the violations of the successful calls.</p>
# of SOAP Faults	<p>The total number of SOAP faults that occurred in calls by the specific consumer.</p>
Availability	<p>The availability of the selected Web services or operations accessed by the specific consumer. The availability is calculated as the number of successful calls made by the specific consumer divided by the total number of calls made by the specific consumer, multiplied by 100.</p> <p>The background is colored according to the comparison between the Web service worst availability and the threshold specified in the Availability KPI definition. For details, see “How Dashboard KPIs Work” in <i>Using Dashboard</i>.</p>
Consumer	<p>The consumer information. For details on the different consumer details, see the Consumer description in the End Point/Consumer Tab in “Active Filter Dialog Box” on page 61.</p> <p>Click the consumer name to drill down to the Health Report for the selected element. For details, see “Health Report” on page 71.</p>

GUI Element (A-Z)	Description
<b>Response Time (sec.)</b>	<p>The average response time (in seconds) of the selected Web services or operations accessed by the specific consumer.</p> <p>The background is colored according to the comparison between the Web service worst response time and the threshold specified in the Response Time KPI definition. For details, see “How Dashboard KPIs Work” in <i>Using Dashboard</i>.</p>
<b>Throughput (calls per min.)</b>	<p>The number of calls, per minute by the specific consumer.</p> <p>The background is colored according to the comparison between the Web service worst throughput and the threshold specified in the Throughput KPI definition. For details, see “How Dashboard KPIs Work” in <i>Using Dashboard</i>.</p>

## Worst Consumer Area

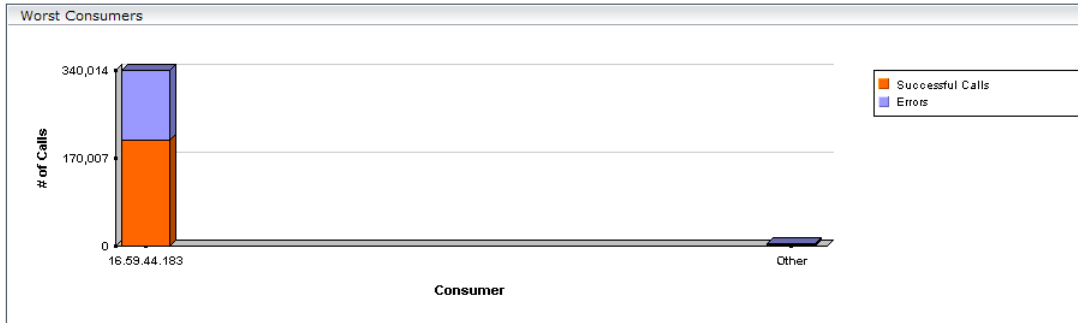

<b>Description</b>	Displays the successful and faulty calls of the worst five consumers accessing the selected Web services, operations, or servers.
<b>Important Information</b>	<p>The Worst Consumer displays the same information in the View as Graph and View as Table tabs.</p> <p>Each tab in the graph represents a different consumer and displays the number of successful calls (in green) and the number of failed calls (in purple).</p> <p>Move the mouse over a tab in the graph to display a tooltip. Hover above a tab to display a tooltip that indicates the consumer, the number of errors, successful calls, SOAP faults, and the number of successful calls.</p> <div data-bbox="625 1046 888 1206" style="border: 1px solid gray; padding: 5px; margin: 10px 0;"> <p><b>Consumer:</b> 16.59.44.183  <b># of Errors:</b> 166,702  <b># of Successful calls:</b> 250,055  <b># of SOAP faults:</b> 166,702  <b># of Calls:</b> 416,757</p> <hr/> <p><a href="#">Drill Down to Health Report</a></p> </div> <p>The X-axis displays the consumer information while the Y-axis displays the number of calls.</p>

The following elements are included (unlabeled GUI elements are shown in angle brackets):

GUI Element (A-Z)	Description
# of Calls	The total number of calls accessed by the specific consumer.
# of Errors	<p>The total number of failed calls by the specific consumer. A failed call is a call that was not performed due to the unavailability of the Web services or operations.</p> <p><b>Configurable:</b> The SOAP faults affecting the availability can be configured in HP Diagnostics when the call is monitored by HP Diagnostics.</p>
# of SOAP Faults	The total number of SOAP faults that occurred in calls by the specific consumer.
# of Successful calls	The number of successful consumer calls.
<drill down>	Click a bar to access the Health report filtered for the consumer.
Consumer	<p>The consumer information. For details on the different consumer details, see “Active Filter Dialog Box” on page 61.</p> <p>Click the consumer name to drill down to the Health Report for the selected element. For details, see “Health Report” on page 71.</p>



## Health Report

<p><b>Description</b></p>	<p>Displays health metrics for the selected Web services, operations, server, endpoint, or consumer in a selected view.</p> <p><b>To Access:</b> Select:</p> <ul style="list-style-type: none"> <li>▶ <b>Applications &gt; Dashboard</b>, select a view in View Explorer: <ul style="list-style-type: none"> <li>▶ In View Explorer, right-click a specific Web Service or Operation CI, and select the <b>Go to Report &gt; Health Report</b> option. The Health Report is filtered by the specific Web service or operation. For details, see “Customize Dashboard Display and Refresh Rate” in <i>Using Dashboard</i></li> <li>▶ In the <b>Console</b>, or <b>Filters</b> tab, right-click a specific Web Service or Operation CI, and select <b>Go to Report &gt; Health Report</b>. The Health Report is filtered by the specific Web service or operation. For details, see “Customize Dashboard Display and Refresh Rate” in <i>Using Dashboard</i></li> </ul> </li> <li>▶ <b>Applications &gt; Business Availability Center for SOA</b>, and select the <b>Health Report</b> option in the Business Availability Center for SOA tab.</li> </ul>
---------------------------	---

<p><b>Important Information</b></p>	<p>To enable you to uncover all available Web Services/operations, the Health report automatically shows all selected Web Services/operations even when they do not have data. You can also check if the Web Service/operation has only <b>Synthetic</b> data or no data at all (<b>Real</b> or <b>Synthetic</b>) and decide to remove the Web Service/operation from the list in the filter.</p> <p><b>Note:</b> You must configure the REST Web Services in the HP Diagnostics application. Once configured, their topology is sent by HP Diagnostics to the UCMDB. REST Web Services are not SOAP Web Services, therefore they provide errors and not SOAP faults. Consequently, the Health report does not display REST Web Services in the report areas that display SOAP faults. The Health report displays how many requests were made to the URL corresponding to the REST Web Service and how many of those requests failed.</p> <p><b>Note:</b> You can add this report as a portlet in My BAC. For details, see “Add Portlets to &lt;page_name&gt;/Add Portlets Dialog Box” in <i>Using My BAC</i>.</p>
<p><b>Included in Tasks</b></p>	<p>“Monitor SOA Environment in Dashboard – Workflow” on page 38</p>
<p><b>Useful Links</b></p>	<p>“Availability Calculation” on page 25</p>









## Report Settings







GUI Element (A-Z)	Description
<Common report settings>	For details, see “Common Report Elements” in <i>Reports</i> .
<b>Active Filter</b>	If relevant, click to select the appropriate conditions for the report. For details, see “Active Filter Dialog Box” on page 61.
<b>Real/Synthetic</b>	<p>Select one of the following:</p> <ul style="list-style-type: none"> <li>▶ <b>Real.</b> To display data from the Diagnostics data collector.</li> <li>▶ <b>Synthetic.</b> To display data from the SiteScope and Business Process monitors.</li> </ul> <p><b>Note:</b> When you generate an SOA report, the <b>Data Type</b> selection is displayed in the top part of the report. When you select <b>Real</b>, each level of the report (except for <b>Endpoint</b>) also displays data for <b>Synthetic</b>. When you select <b>Synthetic</b>, the report displays only information relevant to <b>Synthetic</b>.</p>

## Health Summary Area

When you select more than one service in the Active Filter, the report displays the following data:



Health Summary									
      									
Service ▲	Real							Synthetic	
	Availability (%)	Response Time (Sec.)	Throughput (Calls/Min.)	# of Calls	# of Errors	# of SOAP Faults	# of Slow Calls	Availability (%)	Response Time (Sec.)
com.merc.echo	100.00	0.09	0.01	344	0	0	0	-	-
MedRecWebServ	60.00	0.15	28.23	1,258,616	503,438	503,438	0	98.64	0.26



When you select one service in the Active Filter, the report displays the following data:

Health Summary									
      									
Service / Operation ▲	Real							Synthetic	
	Availability (%)	Response Time (Sec.)	Throughput (Calls/Min.)	# of Calls	# of Errors	# of SOAP Faults	# of Slow Calls	Availability (%)	Response Time (Sec.)
MedRecWebServ	60.00	0.15	28.23	1,258,616	503,438	503,438	0	98.64	0.26
findPatientBy	100.00	0.30	5.65	251,726	0	0	0	100.00	0.22
findPatientBy	100.00	0.08	5.65	251,726	0	0	0	96.03	0.42
getRecord	100.00	0.07	5.65	251,726	0	0	0	100.00	0.12
getRecordsSu	0.00	-	5.65	251,722	251,722	251,722	0	-	-
updatePatien	0.00	-	5.65	251,716	251,716	251,716	0	-	-

<b>Description</b>	<p>Depending on the selection you made in the Active filter, the Health summary area can display:</p> <ul style="list-style-type: none"> <li>▶ A list of same level items (Web services, operations, endpoints, consumers).</li> <li>▶ A tree (Web service/Operations, Operation/Endpoints, Endpoints).</li> </ul> <p>To display other metrics information, click the required item. See above for details.</p>
<b>Important Information</b>	<p>The Health Summary area is the same in the View as Graph and View as Table tabs.</p> <p>Click the required element in the Health Summary report to access details about the health of the element's components. For details about the elements' components, see "Health Summary Area" on page 74.</p> <p>Use the breadcrumbs to go back up the levels you drilled down.</p>

The following elements are included (unlabeled GUI elements are shown in angle brackets>):

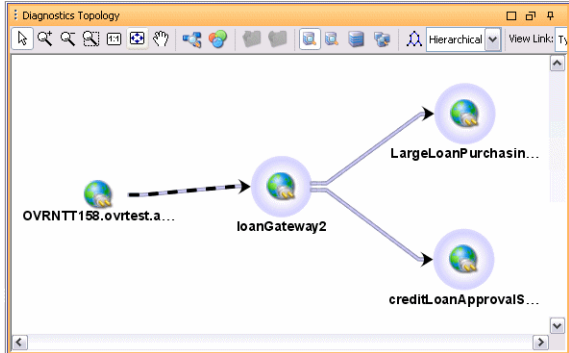
GUI Element (A-Z)	Description
	Click to access the Consumer Summary report for the selected element. For details, see "Consumer Summary Report" on page 65.
	Click to access the Metrics Over Time report for the selected element. For details, see "Metrics Over Time Report" on page 85.
	<p><b>Note:</b> This drill down (<b>Diagnostics Operations</b>) is available only for non-Web Service CIs.</p> <p>Select a CI in the table, and click the button to access the Diagnostics report relevant for the CI (for example the Diagnostics Operations view for an Operation CI) for the selected element. For details, see the <i>HP Diagnostics User's Guide</i>.</p>

GUI Element (A-Z)	Description
	<p><b>Note:</b> This drill down (<b>Diagnostics Web Service Topology</b>) is available only for Web Service CIs.</p> <p>Select a Web Service CI, and click the button to access the Diagnostics Service Topology view for the selected Web Service CI. The graph displays the real-time connections that exist between the selected Web Service CI and other Web Service CIs, for the same timeframe as the report. For details, see <i>HP Diagnostics User's Guide</i>.</p> 
	<p>Click to access the HP SOA Systinet application, focused on the relevant Web service. This option is relevant only when there is an integration between HP Business Availability Center and HP SOA Systinet. For details on the integration with HP SOA Systinet, see “Integration of HP SOA Systinet” on page 26.</p>
<p><b>&lt;Real&gt; # of Calls</b></p>	<p>The total of calls to the specific item. This is a metrics taken from the Diagnostics sample.</p>
<p><b>&lt;Real&gt; # of Errors</b></p>	<p>The total number of failed calls based on the data from the Diagnostics data collector. A failed call is a call that was not performed due to availability problems of the Web services operations. It can be a receiver SOAP fault or an HTTP status code of 5xx-6xx if the call is to a REST service. Note that not all REST services use HTTP status code to indicate failure.</p>

GUI Element (A-Z)	Description
<Real> # of SOAP Faults	The total number of SOAP faults that occurred in calls by the specific consumer based on the data from the Diagnostics data collector.
<Real> Availability	The availability of the item based on the data from the Diagnostics data collector. The background is colored according to the thresholds specified in the Availability KPI definition. The availability is calculated as the number of successful calls to the item, divided by the total number of calls to the item, and multiplied by 100.
<Real> Throughput (Calls/Min.)	The number of calls to the item per minute based on the data from the Diagnostics data collector. The background is colored according to the thresholds specified in the Throughput KPI definition. For details, see “How Dashboard KPIs Work” in <i>Using Dashboard</i> .
<Real> Response Time (sec.)	The response time (in seconds) of the item based on the data from the Diagnostics data collector. The background is colored according to the thresholds specified in the Response Time KPI definition. For details, see “How Dashboard KPIs Work” in <i>Using Dashboard</i> .
<Synthetic> Response Time (sec.)	The response time (in seconds) of the item based on the data from the SiteScope or Business Process monitors. The background is colored according to the thresholds specified in the Response Time KPI definition. For details, see “How Dashboard KPIs Work” in <i>Using Dashboard</i> .

GUI Element (A-Z)	Description
<p><b>Service Operation Service/Operations Operation/Endpoint Endpoint</b></p>	<p>The name of the item whose health metrics are provided in the Health Summary.</p> <p>Click the required element to access details about the health of the element's components. For details about the elements' components, see "Health Summary Area" on page 74.</p>
<p><b>Synthetic Availability (%)</b></p>	<p>The availability of the item based on the data from the SiteScope or Business Process monitors. The background is colored according to the thresholds specified in the Availability KPI definition. The availability is calculated as the number of successful calls to the item, divided by the total number of calls to the item, and multiplied by 100.</p> <p><b>Note:</b> If you monitor the same Web Service with both SiteScope and Business Process Monitor (not recommended), the threshold defined in Business Process Monitor is used to color the background.</p>

### Metrics Area

<p><b>Description</b></p>	<p>The Metrics area displays metrics information for the item listed in the first row of the Health Summary area. If multiple items were selected in the Active Filters, the SOAP Faults area displays the average information for all of the selected items.</p>
<p><b>Important Information</b></p>	<p>You can drill down from each point in the graphs to display more detailed information about the period of time represented by that point. You can drill down to the smallest unit of time (1 hour).</p>

## Graph Format

The following elements are included (unlabeled GUI elements are shown in angle brackets>):

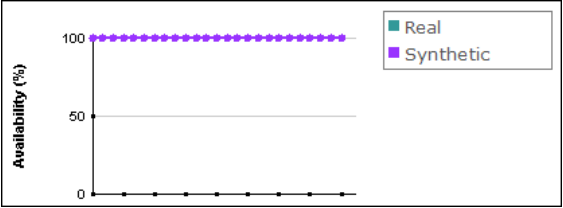
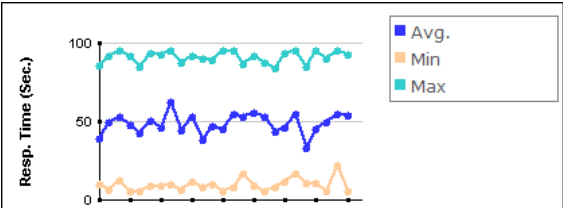
GUI Element (A-Z)	Description
<p><b>Availability (%)</b></p>	<p>The graph displays the availability of the item over the selected time frame of the report in graph format. It displays both real and synthetic data when the <b>Real</b> Data Type is selected, or only synthetic data when the <b>Synthetic</b> Data Type is selected. The legend indicates what is displayed.</p>  <p><b>Note:</b> The Availability of a service in a <b>Real</b> data source does not always display the reality. For example, if the server is down, the calls do not get to the Web service, the Availability of a service in a <b>Real</b> data source indicates that no one called the Web service while the Availability of a service under <b>Synthetic</b> data source indicates that the situation is bad.</p>
<p><b>Response Time (sec)</b></p>	<p>The graph displays the response time (in seconds) of the item over the selected time frame of the report in graph format.</p> <p>The Response Time graph displays information about the <b>Average Response Time (sec.)</b> (purple line), the <b>Max Response Time (sec.)</b> (turquoise line), and the <b>Min Response Time (sec.)</b> (orange line).</p> 

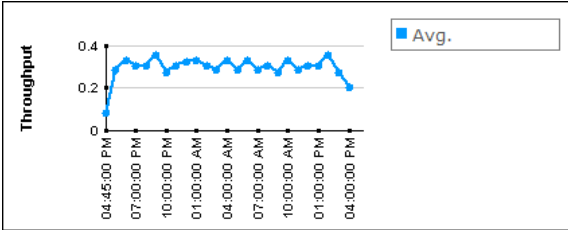
GUI Element (A-Z)	Description																																																																																														
<p><b>Throughput</b></p>	<p>The graph displays the number of calls to the item per minute, over the selected time frame of the report in graph format.</p> <p>The title line of the Metrics area includes the name of the item whose metrics are displayed. If the Health Summary area displays a tree of Operation/Servers the title line of the Metrics area is <b>Aggregated data for selected operations.</b></p>  <table border="1"> <caption>Approximate data points from the Throughput graph</caption> <thead> <tr> <th>Time</th> <th>Throughput (Avg.)</th> </tr> </thead> <tbody> <tr><td>04:45:00 PM</td><td>0.00</td></tr> <tr><td>05:00:00 PM</td><td>0.35</td></tr> <tr><td>05:15:00 PM</td><td>0.32</td></tr> <tr><td>05:30:00 PM</td><td>0.35</td></tr> <tr><td>05:45:00 PM</td><td>0.30</td></tr> <tr><td>06:00:00 PM</td><td>0.32</td></tr> <tr><td>06:15:00 PM</td><td>0.30</td></tr> <tr><td>06:30:00 PM</td><td>0.32</td></tr> <tr><td>06:45:00 PM</td><td>0.30</td></tr> <tr><td>07:00:00 PM</td><td>0.32</td></tr> <tr><td>07:15:00 PM</td><td>0.30</td></tr> <tr><td>07:30:00 PM</td><td>0.32</td></tr> <tr><td>07:45:00 PM</td><td>0.30</td></tr> <tr><td>08:00:00 PM</td><td>0.32</td></tr> <tr><td>08:15:00 PM</td><td>0.30</td></tr> <tr><td>08:30:00 PM</td><td>0.32</td></tr> <tr><td>08:45:00 PM</td><td>0.30</td></tr> <tr><td>09:00:00 PM</td><td>0.32</td></tr> <tr><td>09:15:00 PM</td><td>0.30</td></tr> <tr><td>09:30:00 PM</td><td>0.32</td></tr> <tr><td>09:45:00 PM</td><td>0.30</td></tr> <tr><td>10:00:00 PM</td><td>0.32</td></tr> <tr><td>10:15:00 PM</td><td>0.30</td></tr> <tr><td>10:30:00 PM</td><td>0.32</td></tr> <tr><td>10:45:00 PM</td><td>0.30</td></tr> <tr><td>11:00:00 PM</td><td>0.32</td></tr> <tr><td>11:15:00 PM</td><td>0.30</td></tr> <tr><td>11:30:00 PM</td><td>0.32</td></tr> <tr><td>11:45:00 PM</td><td>0.30</td></tr> <tr><td>12:00:00 AM</td><td>0.32</td></tr> <tr><td>12:15:00 AM</td><td>0.30</td></tr> <tr><td>12:30:00 AM</td><td>0.32</td></tr> <tr><td>12:45:00 AM</td><td>0.30</td></tr> <tr><td>01:00:00 AM</td><td>0.32</td></tr> <tr><td>01:15:00 AM</td><td>0.30</td></tr> <tr><td>01:30:00 AM</td><td>0.32</td></tr> <tr><td>01:45:00 AM</td><td>0.30</td></tr> <tr><td>02:00:00 AM</td><td>0.32</td></tr> <tr><td>02:15:00 AM</td><td>0.30</td></tr> <tr><td>02:30:00 AM</td><td>0.32</td></tr> <tr><td>02:45:00 AM</td><td>0.30</td></tr> <tr><td>03:00:00 AM</td><td>0.32</td></tr> <tr><td>03:15:00 AM</td><td>0.30</td></tr> <tr><td>03:30:00 AM</td><td>0.32</td></tr> <tr><td>03:45:00 AM</td><td>0.30</td></tr> <tr><td>04:00:00 AM</td><td>0.20</td></tr> </tbody> </table>	Time	Throughput (Avg.)	04:45:00 PM	0.00	05:00:00 PM	0.35	05:15:00 PM	0.32	05:30:00 PM	0.35	05:45:00 PM	0.30	06:00:00 PM	0.32	06:15:00 PM	0.30	06:30:00 PM	0.32	06:45:00 PM	0.30	07:00:00 PM	0.32	07:15:00 PM	0.30	07:30:00 PM	0.32	07:45:00 PM	0.30	08:00:00 PM	0.32	08:15:00 PM	0.30	08:30:00 PM	0.32	08:45:00 PM	0.30	09:00:00 PM	0.32	09:15:00 PM	0.30	09:30:00 PM	0.32	09:45:00 PM	0.30	10:00:00 PM	0.32	10:15:00 PM	0.30	10:30:00 PM	0.32	10:45:00 PM	0.30	11:00:00 PM	0.32	11:15:00 PM	0.30	11:30:00 PM	0.32	11:45:00 PM	0.30	12:00:00 AM	0.32	12:15:00 AM	0.30	12:30:00 AM	0.32	12:45:00 AM	0.30	01:00:00 AM	0.32	01:15:00 AM	0.30	01:30:00 AM	0.32	01:45:00 AM	0.30	02:00:00 AM	0.32	02:15:00 AM	0.30	02:30:00 AM	0.32	02:45:00 AM	0.30	03:00:00 AM	0.32	03:15:00 AM	0.30	03:30:00 AM	0.32	03:45:00 AM	0.30	04:00:00 AM	0.20
Time	Throughput (Avg.)																																																																																														
04:45:00 PM	0.00																																																																																														
05:00:00 PM	0.35																																																																																														
05:15:00 PM	0.32																																																																																														
05:30:00 PM	0.35																																																																																														
05:45:00 PM	0.30																																																																																														
06:00:00 PM	0.32																																																																																														
06:15:00 PM	0.30																																																																																														
06:30:00 PM	0.32																																																																																														
06:45:00 PM	0.30																																																																																														
07:00:00 PM	0.32																																																																																														
07:15:00 PM	0.30																																																																																														
07:30:00 PM	0.32																																																																																														
07:45:00 PM	0.30																																																																																														
08:00:00 PM	0.32																																																																																														
08:15:00 PM	0.30																																																																																														
08:30:00 PM	0.32																																																																																														
08:45:00 PM	0.30																																																																																														
09:00:00 PM	0.32																																																																																														
09:15:00 PM	0.30																																																																																														
09:30:00 PM	0.32																																																																																														
09:45:00 PM	0.30																																																																																														
10:00:00 PM	0.32																																																																																														
10:15:00 PM	0.30																																																																																														
10:30:00 PM	0.32																																																																																														
10:45:00 PM	0.30																																																																																														
11:00:00 PM	0.32																																																																																														
11:15:00 PM	0.30																																																																																														
11:30:00 PM	0.32																																																																																														
11:45:00 PM	0.30																																																																																														
12:00:00 AM	0.32																																																																																														
12:15:00 AM	0.30																																																																																														
12:30:00 AM	0.32																																																																																														
12:45:00 AM	0.30																																																																																														
01:00:00 AM	0.32																																																																																														
01:15:00 AM	0.30																																																																																														
01:30:00 AM	0.32																																																																																														
01:45:00 AM	0.30																																																																																														
02:00:00 AM	0.32																																																																																														
02:15:00 AM	0.30																																																																																														
02:30:00 AM	0.32																																																																																														
02:45:00 AM	0.30																																																																																														
03:00:00 AM	0.32																																																																																														
03:15:00 AM	0.30																																																																																														
03:30:00 AM	0.32																																																																																														
03:45:00 AM	0.30																																																																																														
04:00:00 AM	0.20																																																																																														



**Table Format**

The following elements are included (unlabeled GUI elements are shown in angle brackets>):

GUI Element (A-Z)	Description
<b># of Calls</b>	The total number of calls to the item, per time unit.
<b># of Errors</b>	The total number of calls to the item, that failed due to availability problems of the item, per time unit. <b>Configurable:</b> The SOAP faults affecting the availability can be configured in HP Diagnostics when the call is monitored by HP Diagnostics.
<b># of SOAP Faults</b>	The total number of calls to the item, that failed due to a SOAP fault, per time unit.
<b>Availability (%)</b>	The availability of the item, based on the data from the Diagnostics data collector, per time unit.
<b>Max Response Time (sec.)</b>	The highest response time (in seconds) of the item, per time unit.
<b>Min Response Time (sec.)</b>	The lowest response time (in seconds) of the item, per time unit.
<b>Response Time (sec.)</b>	The response time (in seconds) of the item, per time unit.
<b>Synthetic Availability (%)</b>	The availability of the item, based on the data from the SiteScope monitors, per time unit.
<b>Throughput (Calls/Min)</b>	The number of calls to the item per minute of the time unit.
<b>Time</b>	The time units (hour) of the selected time period.

## SOAP Faults Area

<p><b>Description</b></p>	<p>The SOAP Faults area displays information for the item listed in the first row of the Health Summary area. If multiple items were selected in the Active Filters, the SOAP Faults area displays average information for all of the selected items.</p>
<p><b>Important Information</b></p>	<ul style="list-style-type: none"> <li>▶ If you have selected to display synthetic data, the SOAP Faults area displays only the <b>Worst Consumers</b> graph.</li> <li>▶ If you have selected to display real data, the SOAP Faults area displays all the graphs listed below.</li> </ul>

## Graph Format

The following elements are included (unlabeled GUI elements are shown in angle brackets>):

GUI Element (A-Z)	Description																					
<p><b># of Errors</b></p>	<p>Shows the number of calls to the specific item that ended in a SOAP fault over the selected time period.</p> <p>The title line of the SOAP Faults area or of the SOAP Faults table includes the name of the item whose metrics are displayed. If the Health Summary area displays a tree of Operation/Servers the title line of the SOAP Faults area is <b>Aggregated data for selected operations</b>.</p> <div data-bbox="575 1100 1132 1324" data-label="Figure"> <table border="1"> <caption>Graph Data</caption> <thead> <tr> <th>Date</th> <th># of Errors</th> <th># of SOAP Faults</th> </tr> </thead> <tbody> <tr> <td>3/15</td> <td>500,000</td> <td>500,000</td> </tr> <tr> <td>3/17</td> <td>500,000</td> <td>500,000</td> </tr> <tr> <td>3/24</td> <td>500,000</td> <td>500,000</td> </tr> <tr> <td>3/31</td> <td>500,000</td> <td>500,000</td> </tr> <tr> <td>4/7</td> <td>500,000</td> <td>~505,000</td> </tr> <tr> <td>4/14</td> <td>500,000</td> <td>500,000</td> </tr> </tbody> </table> </div> <p><b>Configurable:</b> The SOAP faults affecting the availability can be configured in HP Diagnostics when the call is monitored by HP Diagnostics.</p>	Date	# of Errors	# of SOAP Faults	3/15	500,000	500,000	3/17	500,000	500,000	3/24	500,000	500,000	3/31	500,000	500,000	4/7	500,000	~505,000	4/14	500,000	500,000
Date	# of Errors	# of SOAP Faults																				
3/15	500,000	500,000																				
3/17	500,000	500,000																				
3/24	500,000	500,000																				
3/31	500,000	500,000																				
4/7	500,000	~505,000																				
4/14	500,000	500,000																				

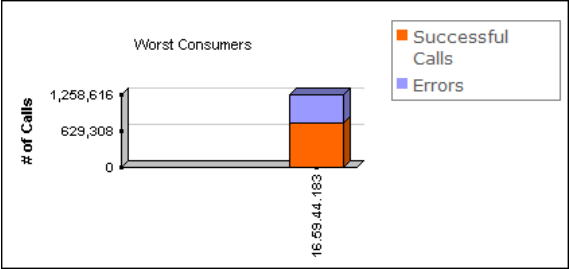
GUI Element (A-Z)	Description
<p><b>Pie chart</b></p>	<p>Represents the faults distribution by type of SOAP fault that occurred when accessing the item during the specified time period. The types of error are: <b>VersionMismatch</b>, <b>MustUnderstand</b>, <b>Sender</b>, <b>Receiver</b>, and <b>DataEncodingUnknown</b>. The tooltip displays the number of faults of the type represented by the slice. The legend lists the SOAP Fault types.</p> 
<p><b>Worst Consumers</b></p>	<p>Displays, for the five worst consumers (with the largest number of faulty calls), the number of successful calls (in orange) and the number of calls that ended in error or SOAP faults (in purple) to the item.</p> 

**Table Format**

The following elements are included (unlabeled GUI elements are shown in angle brackets>):

GUI Element (A-Z)	Description
<b>SOAP Faults Distribution</b>	Shows the percentage of the occurrence of each type of SOAP fault compared to the total number of SOAP faults: <b>VersionMismatch</b> , <b>MustUnderstand</b> , <b>Sender</b> , <b>Receiver</b> , or <b>DataEncodingUnknown</b> .
<b>SOAP Faults and Errors Overtime</b>	Displays the total number of calls to the selected item that ended in a SOAP fault and the total number of calls to the selected item that ended in an error, over the selected time period, per unit of time.
<b>Worst Consumers</b>	Displays the number of calls to the selected item that ended in an error in the <b># of Errors</b> column, the number of calls to the selected item that ended in a SOAP fault in the <b># of SOAP Faults</b> column, the number of successful calls to the selected item in the <b># of Successful Calls</b> column, and the total number of calls in the <b># of Calls</b> column, per consumer, for the five worst consumers (with the largest number of faulty calls).

## Metrics Over Time Report

<b>Description</b>	<p>Displays the performance of selected metrics related to a selected view and selected CIs, over time.</p> <p><b>To Access:</b> Select <b>Applications &gt; Business Availability Center for SOA</b>, and select the <b>Metrics Over Time Report</b> option in the Business Availability Center for SOA tab.</p>
<b>Important Information</b>	<p>Move the mouse over a tab in the appropriate graphs to display the tooltip that includes the information listed in the table.</p> <ul style="list-style-type: none"> <li>➤ For a Web service:           <div data-bbox="618 612 958 760" style="border: 1px solid black; padding: 5px; margin: 10px 0;"> <p style="text-align: center;"><b>Details</b></p> <p><b>Namespace:</b> http://www.bea.com/medrec <b>Web Service:</b> MedRecWebServices</p> <hr/> <p><b>Availability (%):</b> 60.00 <b>Time:</b> 4/15 02:00:00 AM</p> </div> </li> <li>➤ For an operation:           <div data-bbox="618 812 1093 977" style="border: 1px solid black; padding: 5px; margin: 10px 0;"> <p style="text-align: center;"><b>Details</b></p> <p><b>Namespace:</b> http://sampleweb.com/services/SlowService <b>Web Service:</b> SlowService <b>Operation:</b> doSomeWork</p> <hr/> <p><b>Availability (%):</b> 100.00 <b>Time:</b> 4/7</p> </div> </li> </ul> <p>The tooltip displays the following information:</p> <ul style="list-style-type: none"> <li>➤ <b>Namespace.</b> The namespace of the Web service.</li> <li>➤ <b>Web Service/Operation.</b> The name of the selected Web service/operation.</li> <li>➤ <b>&lt;metric&gt;.</b> The value of the metric at this point.</li> </ul> <p><b>Note:</b> You can add this report as a portlet in My BAC. For details, see “Add Portlets to &lt;page_name&gt;/Add Portlets Dialog Box” in <i>Using My BAC</i>.</p>
<b>Included in Tasks</b>	<p>“Monitor SOA Environment in Dashboard – Workflow” on page 38</p>

## Report Settings

GUI Element (A-Z)	Description
<Common report settings>	For details, see “Common Report Elements” in <i>Reports</i> .
Active Filter	If relevant, click to select the appropriate conditions for the report. For details, see “Active Filter Dialog Box” on page 61.
Real/Synthetic	<p>Select one of the following:</p> <ul style="list-style-type: none"> <li>▶ <b>Real.</b> To display data from the Diagnostics data collector.</li> <li>▶ <b>Synthetic.</b> To display data from the SiteScope and Business Process monitors.</li> </ul> <p><b>Note:</b> When you generate an SOA report, the <b>Data Type</b> selection is displayed in the top part of the report.</p>

## Graph and Table Settings

The following elements are included (unlabeled GUI elements are shown in angle brackets):

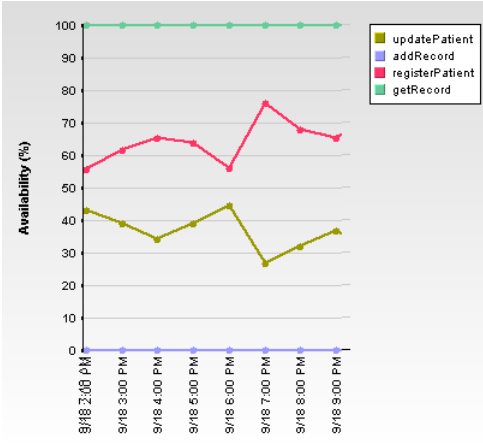
GUI Element (A-Z)	Description																																													
<graph details>	<p>The View as Graph tab displays the selected metric performance of the selected Web services, operations, endpoints, or consumers, during the selected time frame of the report.</p> <p>The graph legend indicates the color used to display the metric information of the Web services if Web services were selected or operations if Operations were selected in the Active Filters.</p>  <table border="1"> <caption>Availability (%) Data</caption> <thead> <tr> <th>Time</th> <th>updatePatient (%)</th> <th>addRecord (%)</th> <th>registerPatient (%)</th> <th>getRecord (%)</th> </tr> </thead> <tbody> <tr> <td>9/18 2:00 PM</td> <td>45</td> <td>0</td> <td>55</td> <td>100</td> </tr> <tr> <td>9/18 3:00 PM</td> <td>38</td> <td>0</td> <td>62</td> <td>100</td> </tr> <tr> <td>9/18 4:00 PM</td> <td>35</td> <td>0</td> <td>65</td> <td>100</td> </tr> <tr> <td>9/18 5:00 PM</td> <td>38</td> <td>0</td> <td>63</td> <td>100</td> </tr> <tr> <td>9/18 6:00 PM</td> <td>45</td> <td>0</td> <td>55</td> <td>100</td> </tr> <tr> <td>9/18 7:00 PM</td> <td>25</td> <td>0</td> <td>75</td> <td>100</td> </tr> <tr> <td>9/18 8:00 PM</td> <td>32</td> <td>0</td> <td>68</td> <td>100</td> </tr> <tr> <td>9/18 9:00 PM</td> <td>38</td> <td>0</td> <td>65</td> <td>100</td> </tr> </tbody> </table>	Time	updatePatient (%)	addRecord (%)	registerPatient (%)	getRecord (%)	9/18 2:00 PM	45	0	55	100	9/18 3:00 PM	38	0	62	100	9/18 4:00 PM	35	0	65	100	9/18 5:00 PM	38	0	63	100	9/18 6:00 PM	45	0	55	100	9/18 7:00 PM	25	0	75	100	9/18 8:00 PM	32	0	68	100	9/18 9:00 PM	38	0	65	100
Time	updatePatient (%)	addRecord (%)	registerPatient (%)	getRecord (%)																																										
9/18 2:00 PM	45	0	55	100																																										
9/18 3:00 PM	38	0	62	100																																										
9/18 4:00 PM	35	0	65	100																																										
9/18 5:00 PM	38	0	63	100																																										
9/18 6:00 PM	45	0	55	100																																										
9/18 7:00 PM	25	0	75	100																																										
9/18 8:00 PM	32	0	68	100																																										
9/18 9:00 PM	38	0	65	100																																										
<right-click a point in the graph>	<p>To display the Available Drilldowns menu, and select:</p> <ul style="list-style-type: none"> <li>➤ <b>Drill Down to Health Report.</b> To display the Health report for the selected Web service or operation for the selected time period. For details, see “Health Report” on page 71</li> <li>➤ <b>Time Range Drill Down.</b> To display the metrics for the selected Web service or operation for the selected time period.</li> </ul>																																													

GUI Element (A-Z)	Description
<table details>	The View as Table tab displays the selected Web services, or operations performance of the selected metric, during the selected time frame of the report.  The table displays the Web service and/or operation, the namespace of the Web service, and the value of the metric per time unit.
<b>Generate</b>	Click to generate the report.



GUI Element (A-Z)	Description
<b>Metrics</b>	<p>Select the metric whose performance during the selected time period, you want to display. You can select:</p> <ul style="list-style-type: none"> <li>▶ <b>Availability.</b> The average availability (in percentage) of the selected Web services or operations, running on the selected servers, and accessed by the selected consumer during the selected time frame of the report.</li> <li>▶ <b>Throughput.</b> The number of calls running on the selected server, by the selected consumer, per minute, during the selected time frame of the report.</li> <li>▶ <b>Avg. Response Time (sec.).</b> The average response time (in seconds) of the selected Web services or operations, running on the selected server, by the selected consumer during the selected time frame of the report.</li> <li>▶ <b># of Calls.</b> The total number of calls, running on the selected server, by the selected consumer, during the selected time frame of the report.</li> <li>▶ <b># of Errors.</b> The total number of faulty calls, running on the selected server, by the selected consumer, during the selected time frame of the report. A faulty call is a call that fails due to the unavailability of the called item.</li> <li>▶ <b># of Slow Calls.</b> The total number of slow calls, running on the selected server, by the selected consumer, during the selected time frame of the report. A slow call is a call with a response time that is longer than the predefined threshold.</li> <li>▶ <b># of SOAP Faults.</b> The total number of SOAP faults that occurred in calls by the specific consumer.</li> </ul>
<b>View as Graph tab</b>	Click to display the report in graph format.
<b>View as Table tab</b>	Click to display the report in table format.

## Server and Endpoint Summary Report

<p><b>Description</b></p>	<p>Displays a drillable summary of the metrics for all of the servers or endpoints on which the selected Web services or operations of a selected view are running.</p> <p><b>To Access:</b> Select <b>Application &gt; Business Availability Center for SOA</b>, click the <b>Business Availability Center for SOA</b> tab, and select the <b>Server and Endpoint Summary Report</b> option in the Business Availability Center for SOA tab.</p>
<p><b>Important Information</b></p>	<p>When you select <b>Real</b>, the report displays information only for the consumers that were registered in the Diagnostics system. All other consumers are aggregated and presented as <b>Others</b>.</p> <p>The report is available only if the Server IP field exists in the sample.</p> <p>Move the mouse over a tab in a graph to display a tooltip that indicates the number of errors, successful calls, SOAP faults, and the total number of calls to the selected server.</p> <div data-bbox="582 881 859 1050" style="border: 1px solid black; padding: 5px; margin: 10px 0;"> <p>Server IP: 16.59.56.159                  # of Errors: 0                  # of Successful calls: 5,549                  # of SOAP faults: 0                  # of Calls: 5,549</p> <hr/> <p><b>Available Drilldowns:</b>                  Drill Down to Health Report                  Drill Down to Endpoint Summary report</p> </div> <p><b>Note:</b> You can add this report as a portlet in My BAC. For details, see “Add Portlets to &lt;page_name&gt;/Add Portlets Dialog Box” in <i>Using My BAC</i>.</p>
<p><b>Included in Tasks</b></p>	<p>“Monitor SOA Environment in Dashboard – Workflow” on page 38</p>

### Report Settings

GUI Element (A-Z)	Description
<Common report settings>	For details, see “Common Report Elements” in <i>Reports</i> .

GUI Element (A-Z)	Description
<b>Active Filter</b>	If relevant, click to select the appropriate conditions for the report. For details, see “Active Filter Dialog Box” on page 61.
<b>Real/Synthetic</b>	Select one of the following: <ul style="list-style-type: none"> <li>▶ <b>Real.</b> To display data from the Diagnostics data collector.</li> <li>▶ <b>Synthetic.</b> To display data from the SiteScope and Business Process monitors.</li> </ul> <b>Note:</b> When you generate an SOA report, the <b>Data Type</b> selection is displayed in the top part of the report.
<b>Report Granularity</b>	Select one of the following: <ul style="list-style-type: none"> <li>▶ <b>Servers.</b> To display the Server and Endpoint Summary report with information about the servers.</li> <li>▶ <b>Endpoints.</b> To display the Server and Endpoint Summary report with information about the endpoints.</li> </ul>

## Server/Endpoint Summary Area

Server Summary								
Server ▲	Availability (%)	Response Time (Sec.)	Throughput	# of Calls	# of Errors	# of SOAP Faults	# of Slow Calls	
15.8.153.82 ▼	100.00	0.99	0.77	34,389	0	0	0	▲
15.8.155.186 ▼	100.00	0.43	0.97	43,026	0	0	0	5
16.59.56.159 ▼	99.98	8.51	0.73	32,441	8	8	3,059	
16.59.63.27 ▼	99.81	1.98	1.80	80,295	154	154	311	
16.59.63.51 ▼	99.82	0.02	0.13	6,017	11	11	0	
16.59.63.58 ▼	99.93	0.04	0.03	1,536	1	1	0	
16.59.63.70 ▼	71.04	0.78	6.84	305,067	88,349	88,349	40	
16.59.63.72 ▼	88.53	0.01	3.42	152,478	17,482	80,289	7	

Endpoint Summary								
Endpoint	Server ▲	Availability (%)	Response Time (Sec.)	Throughput	# of Calls	# of Errors	# of SOAP Faults	# of Slow Calls
JavaTrader2_hps	15.8.153.82	100.00	0.99	0.77	34,389	0	0	0
AquaLogic_hpswr	15.8.155.186	100.00	0.43	0.97	43,026	0	0	5

<b>Description</b>	Displays the health metrics for all of the servers/endpoints on which the selected Web services or operations are running. If, in the Active Filters, you also select specific endpoint or consumer, the health metrics are further filtered by the selected endpoint or consumer.
<b>Important Information</b>	The Server Summary area is the same in the View as Graph and View as Table tabs.

The following elements are included (unlabeled GUI elements are shown in angle brackets>):

GUI Element (A-Z)	Description
	Select an elements and click the button to drill down to the Health Report for the selected element. For details, see “Health Report” on page 71.
<b># of Calls</b>	The total number of calls to the server accessed by the Web services, operations, or consumer.

GUI Element (A-Z)	Description
# of Errors	<p>The total number of errors that occurred in calls by the specific consumer.</p> <p><b>Configurable:</b> The SOAP faults affecting the availability can be configured in HP Diagnostics when the call is monitored by HP Diagnostics.</p>
# of Slow Calls	<p>The number of slow calls that occurred in calls by the specific consumer.</p> <p>A slow call is a call with a response time that is longer than a predefined threshold.</p> <p><b>Note:</b> The value displayed by # of Slow Calls is different from the value of the <b>Total Threshold Violation</b> in HP Diagnostics. In HP Diagnostics the <b>Total Threshold Violation</b> includes the overall number of violation from all the calls and in HP Business Availability Center # of <b>Slow Calls</b> includes only the violations of the successful calls.</p>
# of SOAP Faults	<p>The total number of SOAP faults that occurred in calls by the specific consumer.</p>
Availability (%)	<p>The availability of the server accessed by the selected Web services, operations, or consumer. The availability is calculated as the number of successful calls made to the server divided by the total number of calls made to the server, multiplied by 100.</p> <p>The background is colored according to the threshold specified in the Availability KPI definition. For details, see “How Dashboard KPIs Work” in <i>Using Dashboard</i>.</p>
Endpoint	<p>The name of the endpoint.</p> <p><b>Note:</b> This column is displayed only when you select the <b>Endpoints</b> report granularity.</p> <p>Click the endpoint to drill down to the Health Report for the selected element. For details, see “Health Report” on page 71.</p>

GUI Element (A-Z)	Description
<p><b>Response Time (sec.)</b></p>	<p>The average response time (in seconds) of the server accessed by the selected Web services, operations, or consumer.</p> <p>The background is colored according to the threshold specified in the Response Time KPI definition. For details, see “How Dashboard KPIs Work” in <i>Using Dashboard</i>.</p>
<p><b>Server</b></p>	<p>The IP number of the server.</p> <p>Click the gray arrow to the right of the server to display drill down menu options where you can select the <b>Drill Down to Health Report</b> or <b>Drill Down to Endpoint Summary Report</b> options to access the relevant report for the element.</p>
<p><b>Throughput (calls per min.)</b></p>	<p>The number of calls, per minute, to the server by the selected Web services, operations, or consumer.</p> <p>The background is colored according to the threshold specified in the Throughput KPI definition. For details, see “How Dashboard KPIs Work” in <i>Using Dashboard</i>.</p>

## Worst Server Area

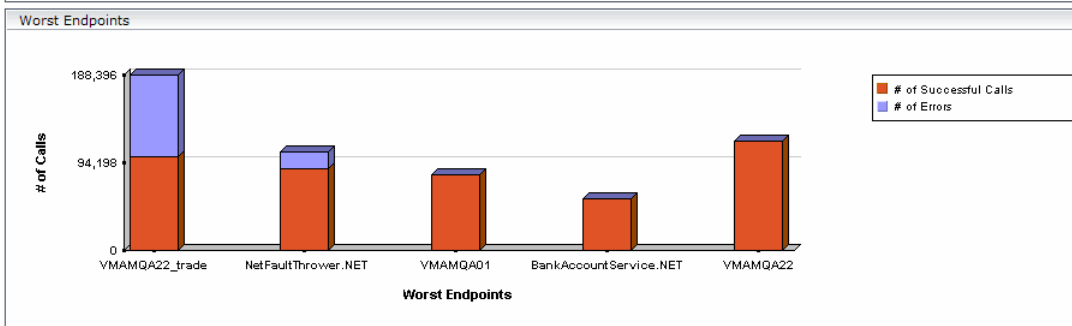
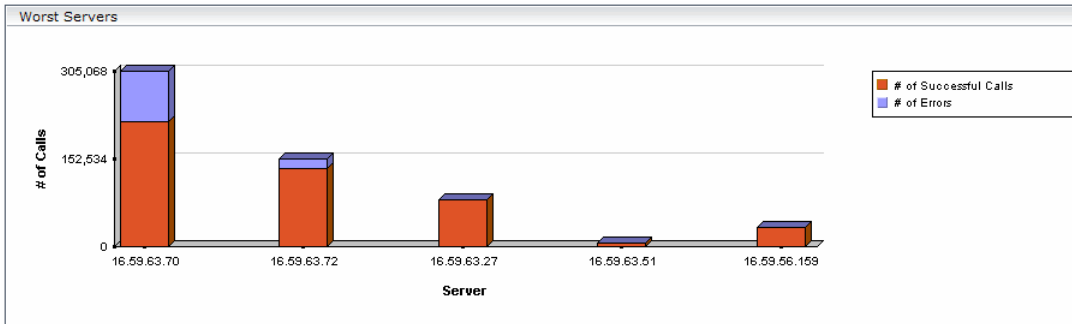

<b>Description</b>	Displays the successful and faulty calls of the worst five servers/endpoints accessed by the selected Web services, operations, or consumer.
<b>Important Information</b>	<p>The Worst Server area and the Worst Endpoint area display the same information in the View as Graph and View as Table tabs.</p> <p>Each tab in the graph represents one of the five worst servers or endpoints and displays the number of successful calls (in red) and the number of faulty calls (in purple).</p>

The following elements are included (unlabeled GUI elements are shown in angle brackets>):

GUI Element (A-Z)	Description
# of Calls	The total number of calls to the server accessed by the Web services, operations, or consumer.
# of Errors	The number of calls to the server that ended with an error. <b>Configurable:</b> The SOAP faults affecting the availability can be configured in HP Diagnostics when the call is monitored by HP Diagnostics.
# of SOAP Faults	The total number of SOAP faults that occurred in calls by the specific consumer.
# of Successful calls	The number of calls to the server that were successful.
Endpoint	The name of the worst endpoint.
Server	The IP number of the worst server.



## Top Metrics Report

<b>Description</b>	<p>Displays the top metrics information about the traffic to and from all of the monitored Web services or operations in a specific view.</p> <p><b>To Access:</b> Select <b>Applications &gt; Business Availability Center for SOA</b>, and select the <b>Top Metrics</b> option in the Business Availability Center for SOA tab.</p>
<b>Important Information</b>	<p>Move the mouse over a tab in the appropriate graphs to display the tooltip that includes the information listed in the table.</p> <div data-bbox="615 557 861 782" style="border: 1px solid black; padding: 5px;"> <p style="text-align: center; margin: 0;"><b>Details</b></p> <p>Namespace: http://example.org Name: creditLoanApprovalService</p> <hr/> <p>Availability (%): 100.00 Avg. Response Time (Sec.): 0.00 # of Calls: 9,921 # of Errors: 0 # of SOAP Faults: 0 # of Slow Calls: 1</p> <hr/> <p style="text-align: center; font-size: small;">Drill Down to Health Report</p> </div> <p><b>Note:</b> You can add this report as a portlet in My BAC. For details, see “Add Portlets to &lt;page_name&gt;/Add Portlets Dialog Box” in <i>Using My BAC</i>.</p>
<b>Included in Tasks</b>	“Monitor SOA Environment in Dashboard – Workflow” on page 38

### Report Settings

The following elements are included (unlabeled GUI elements are shown in angle brackets):

GUI Element (A-Z)	Description
<Common report settings>	For details, see “Common Report Elements” in <i>Reports</i> .

GUI Element (A-Z)	Description
<b>Active Filter</b>	If relevant, click to select the appropriate conditions for the report. For details, see “Active Filter Dialog Box” on page 61.
<b>Real/Synthetic</b>	Select one of the following: <ul style="list-style-type: none"> <li>➤ <b>Real.</b> To display data from the Diagnostics data collector.</li> <li>➤ <b>Synthetic.</b> To display data from the SiteScope and Business Process monitors.</li> </ul> <p><b>Note:</b> When you generate an SOA report, the <b>Data Type</b> selection is displayed in the top part of the report.</p>

### Top Area

The following elements are included (unlabeled GUI elements are shown in angle brackets>):

GUI Element (A-Z)	Description
	From the View as Table tab, click the <b>Health report drill down</b> button corresponding to: <ul style="list-style-type: none"> <li>➤ a specific Web service to open the Health Report of the Web service’s operation in table format.</li> <li>➤ a specific operation, to open the Health Report of the operation’s servers in table format.</li> </ul>
<bar in graph>	From the View as Graph tab, click the bar that corresponds to: <ul style="list-style-type: none"> <li>➤ a specific Web service to open the Health Report of the Web service’s operations in graph format.</li> <li>➤ a specific operation to open the Health Report of the operation’s servers in graph format.</li> </ul>
<b>Report Granularity</b>	Select: <ul style="list-style-type: none"> <li>➤ <b>Web services</b> to display the top metrics information for the selected Web services.</li> <li>➤ <b>Operations</b> to display the top metrics information for the selected operations.</li> </ul>

## Web Services-Related Graphs

The following elements are included (unlabeled GUI elements are shown in angle brackets>):

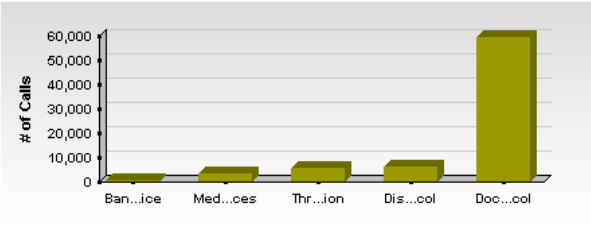
GUI Element (A-Z)	Description												
<p><b>Least Active Web Services</b></p>	<p>Displays the five Web services that received the lowest number of calls (that is, were least used), during the selected time frame of the report. Each tab represents the total number of calls to the Web service.</p> <div data-bbox="621 520 1235 807" style="border: 1px solid gray; padding: 5px;"> <p style="text-align: center; margin: 0;">Least Active Web Services</p>  <table border="1" style="display: none;"> <caption>Data for Least Active Web Services Graph</caption> <thead> <tr> <th>Service</th> <th>Approximate # of Calls</th> </tr> </thead> <tbody> <tr> <td>Ban...ice</td> <td>~2,000</td> </tr> <tr> <td>Med...ces</td> <td>~5,000</td> </tr> <tr> <td>Thr...ion</td> <td>~8,000</td> </tr> <tr> <td>Dis...ool</td> <td>~10,000</td> </tr> <tr> <td>Doc...ool</td> <td>~58,000</td> </tr> </tbody> </table> </div> <p>This graph is displayed if you have selected the <b>Web Services</b> report granularity.</p> <p>For details about the table columns, see “Web Services-Related Table” on page 103.</p>	Service	Approximate # of Calls	Ban...ice	~2,000	Med...ces	~5,000	Thr...ion	~8,000	Dis...ool	~10,000	Doc...ool	~58,000
Service	Approximate # of Calls												
Ban...ice	~2,000												
Med...ces	~5,000												
Thr...ion	~8,000												
Dis...ool	~10,000												
Doc...ool	~58,000												

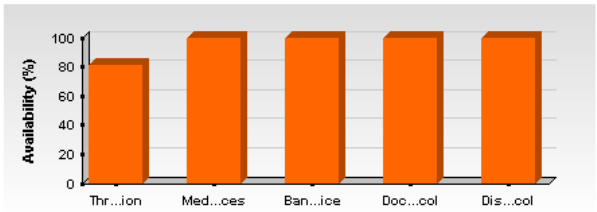
GUI Element (A-Z)	Description												
<p><b>Least Available Web Services</b></p>	<p>Displays the availability of the five Web services with the lowest availability, during the selected time frame of the report. The availability is calculated as the number of successful calls to the Web service, divided by the total number of calls to the Web service, and multiplied by 100.</p> <div data-bbox="576 444 1196 736" style="border: 1px solid gray; padding: 5px;"> <p style="text-align: center; margin: 0;">Least Available Web Services</p>  <table border="1" style="margin-top: 10px; width: 100%; border-collapse: collapse;"> <caption>Data from Least Available Web Services Chart</caption> <thead> <tr> <th>Web Service</th> <th>Availability (%)</th> </tr> </thead> <tbody> <tr> <td>Thr...ion</td> <td>~85</td> </tr> <tr> <td>Med...ces</td> <td>100</td> </tr> <tr> <td>Ban...ice</td> <td>100</td> </tr> <tr> <td>Doc...col</td> <td>100</td> </tr> <tr> <td>Dis...col</td> <td>100</td> </tr> </tbody> </table> </div> <p>This graph is displayed if you have selected the <b>Web Services</b> report granularity.</p> <p>For details about the table columns, see “Web Services-Related Table” on page 103.</p>	Web Service	Availability (%)	Thr...ion	~85	Med...ces	100	Ban...ice	100	Doc...col	100	Dis...col	100
Web Service	Availability (%)												
Thr...ion	~85												
Med...ces	100												
Ban...ice	100												
Doc...col	100												
Dis...col	100												

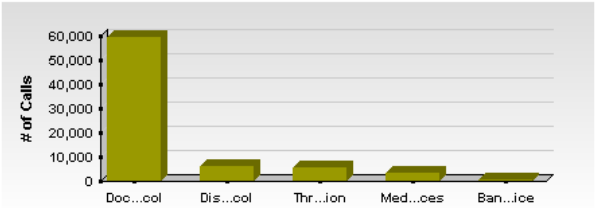
GUI Element (A-Z)	Description												
<p><b>Most Active Web Services</b></p>	<p>Displays the five Web services with the highest number of calls, during the selected time frame of the report. Each tab represents the total number of calls to the Web service.</p> <div data-bbox="621 378 1239 668" style="border: 1px solid gray; padding: 5px;"> <p style="text-align: center; margin: 0;">Most Active Web Services</p>  <table border="1" style="margin: 5px auto; border-collapse: collapse;"> <caption>Data from 'Most Active Web Services' Chart</caption> <thead> <tr> <th>Web Service</th> <th>Approximate # of Calls</th> </tr> </thead> <tbody> <tr> <td>Doc...ool</td> <td>60,000</td> </tr> <tr> <td>Dis...ool</td> <td>10,000</td> </tr> <tr> <td>Thr...ion</td> <td>8,000</td> </tr> <tr> <td>Med...ces</td> <td>5,000</td> </tr> <tr> <td>Ban...ice</td> <td>2,000</td> </tr> </tbody> </table> </div> <p>This graph is displayed if you have selected the <b>Web Services</b> report granularity.</p> <p>For details about the table columns, see “Web Services-Related Table” on page 103.</p>	Web Service	Approximate # of Calls	Doc...ool	60,000	Dis...ool	10,000	Thr...ion	8,000	Med...ces	5,000	Ban...ice	2,000
Web Service	Approximate # of Calls												
Doc...ool	60,000												
Dis...ool	10,000												
Thr...ion	8,000												
Med...ces	5,000												
Ban...ice	2,000												

GUI Element (A-Z)	Description												
<p><b>Slowest Web Services</b></p>	<p>Displays the five slowest Web services in the selected time frame of the report. A slow Web service is defined as having the longest response time (no matter the threshold value). Each tab represents the average of the response times for the Web service during the time frame of the report.</p> <div data-bbox="582 442 1196 732" data-label="Figure"> <table border="1"> <caption>Slowest Web Services</caption> <thead> <tr> <th>Web Service</th> <th>Avg. Response Time (Sec.)</th> </tr> </thead> <tbody> <tr> <td>Med...ces</td> <td>0.10</td> </tr> <tr> <td>Ban...ice</td> <td>0.02</td> </tr> <tr> <td>Thr...ion</td> <td>0.01</td> </tr> <tr> <td>Doc...col</td> <td>0.01</td> </tr> <tr> <td>Dis...col</td> <td>0.01</td> </tr> </tbody> </table> </div> <p>This graph is displayed if you have selected the <b>Web Services</b> report granularity. For details about the table columns, see “Web Services-Related Table” on page 103.</p>	Web Service	Avg. Response Time (Sec.)	Med...ces	0.10	Ban...ice	0.02	Thr...ion	0.01	Doc...col	0.01	Dis...col	0.01
Web Service	Avg. Response Time (Sec.)												
Med...ces	0.10												
Ban...ice	0.02												
Thr...ion	0.01												
Doc...col	0.01												
Dis...col	0.01												
<p><b>Web Services with Most Errors</b></p>	<p>Displays the five Web services with the largest number of failed values, during the selected time frame of the report. Each tab represents the total number of calls that ended in errors, received by the Web service.</p> <div data-bbox="582 1067 1196 1357" data-label="Figure"> <table border="1"> <caption>Web Services with Most Errors</caption> <thead> <tr> <th>Web Service</th> <th># of Errors</th> </tr> </thead> <tbody> <tr> <td>Thr...ion</td> <td>1000</td> </tr> <tr> <td>Med...ces</td> <td>100</td> </tr> <tr> <td>Ban...ice</td> <td>50</td> </tr> <tr> <td>Doc...col</td> <td>50</td> </tr> <tr> <td>Dis...col</td> <td>50</td> </tr> </tbody> </table> </div> <p>This graph is displayed if you have selected the <b>Web Services</b> report granularity. For details about the table columns, see “Web Services-Related Table” on page 103.</p>	Web Service	# of Errors	Thr...ion	1000	Med...ces	100	Ban...ice	50	Doc...col	50	Dis...col	50
Web Service	# of Errors												
Thr...ion	1000												
Med...ces	100												
Ban...ice	50												
Doc...col	50												
Dis...col	50												

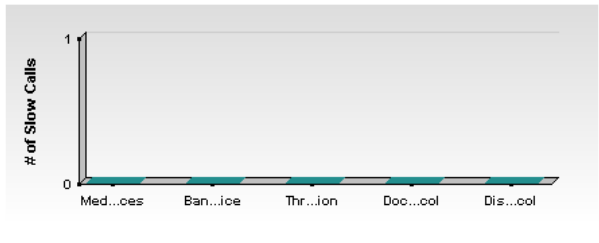
GUI Element (A-Z)	Description
<p><b>Web Services with Most Slow Calls</b></p>	<p>Displays the five Web services with the highest number of slow calls, in the selected time frame of the report. A slow call is defined as a call that lasts longer than a predefined threshold. Each tab represents the total number of slow calls received by the Web service.</p> <div data-bbox="614 413 1232 699" style="border: 1px solid black; padding: 5px;"> <p style="text-align: center; margin: 0;">Web Services With Most Slow Calls</p>  </div> <p>This graph is displayed if you have selected the <b>Web Services</b> report granularity.</p> <p>For details about the table columns, see “Web Services-Related Table” on page 103.</p>

### Web Services-Related Table

The Least Active Web Services, Slowest Web Services, Web Services with Most SOAP Faults, Web Services with Most Slow Calls, Most Active Web Services, or Least Active Web Services table in the Top Metrics Report screen includes the following elements:

GUI Element (A-Z)	Description
# of Calls	<p>The total number of calls to the specific Web service during the selected time frame of the report.</p>
# of Errors	<p>The number of calls to the specific Web service, during the selected time frame of the report, that failed due to the unavailability of the Web service.</p> <p><b>Configurable:</b> The SOAP faults affecting the availability can be configured in HP Diagnostics when the call is monitored by HP Diagnostics.</p>

GUI Element (A-Z)	Description
# of Slow Calls	<p>The number of slow calls to the specific Web service during the selected time frame of the report. A slow call is a call with a response time that is longer than a predefined threshold.</p> <p><b>Note:</b> The value displayed by <b># of Slow Calls</b> is different from the value of the <b>Total Threshold Violation</b> in HP Diagnostics. In HP Diagnostics the <b>Total Threshold Violation</b> includes the overall number of violation from all the calls and in HP Business Availability Center <b># of Slow Calls</b> includes only the violations of the successful calls.</p>
# of SOAP Faults	<p>The number of calls to the specific Web service, during the selected time frame of the report, that ended in SOAP faults.</p>
Availability (%)	<p>The average availability of the Web service during the selected time frame of the report. The availability is calculated as the number of successful calls to the Web service, divided by the total number of calls to the Web service, and multiplied by 100.</p>
Avg. Response Time (sec.)	<p>The average response time (in seconds) of the Web service during the selected time frame of the report.</p>
Name	<p>The name of the selected Web service.</p>
NameSpace	<p>The name space of the Web service.</p>



## Operations-Related Graphs

The following elements are included (unlabeled GUI elements are shown in angle brackets>):

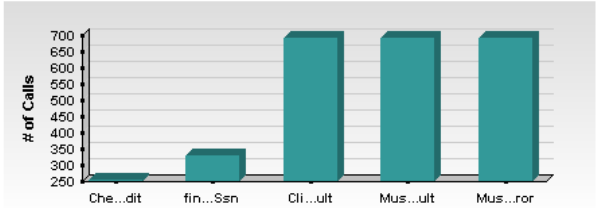
GUI Element (A-Z)	Description												
<p><b>Least Active Operations</b></p>	<p>Displays the five operations that received the lowest number of calls (that is, were least used), during the selected time frame of the report. Each tab represents the total number of calls to the operation.</p> <div data-bbox="618 522 1238 812" style="border: 1px solid gray; padding: 5px;"> <p style="text-align: center; margin: 0;">Least Active Operations</p>  <table border="1" style="margin-top: 10px; width: 100%; border-collapse: collapse;"> <caption>Data for Least Active Operations Graph</caption> <thead> <tr> <th>Operation</th> <th>Number of Calls (Approximate)</th> </tr> </thead> <tbody> <tr> <td>Che...dit</td> <td>250</td> </tr> <tr> <td>fin...Ssn</td> <td>350</td> </tr> <tr> <td>Cli...ult</td> <td>680</td> </tr> <tr> <td>Mus...ult</td> <td>680</td> </tr> <tr> <td>Mus...ror</td> <td>680</td> </tr> </tbody> </table> </div> <p>This graph is displayed if you have selected the Operations report granularity.</p> <p>For details about the table columns, see “Operations-Related Table” on page 109.</p>	Operation	Number of Calls (Approximate)	Che...dit	250	fin...Ssn	350	Cli...ult	680	Mus...ult	680	Mus...ror	680
Operation	Number of Calls (Approximate)												
Che...dit	250												
fin...Ssn	350												
Cli...ult	680												
Mus...ult	680												
Mus...ror	680												

GUI Element (A-Z)	Description												
<p><b>Least Available Operations</b></p>	<p>Displays the availability of the five <b>operations</b> with the lowest availability, during the selected time frame of the report. The availability is calculated as the number of successful calls to the <b>operation</b>, divided by the total number of calls to the operation, and multiplied by 100.</p> <div data-bbox="582 442 1200 732" data-label="Figure"> <table border="1"> <caption>Least Available Operations Data</caption> <thead> <tr> <th>Operation</th> <th>Availability (%)</th> </tr> </thead> <tbody> <tr> <td>Ser...ult</td> <td>~2</td> </tr> <tr> <td>fin...Ssn</td> <td>100</td> </tr> <tr> <td>getRecord</td> <td>100</td> </tr> <tr> <td>get...ary</td> <td>100</td> </tr> <tr> <td>Che...dit</td> <td>100</td> </tr> </tbody> </table> </div> <p>This graph is displayed if you have selected the Operations report granularity. For details about the table columns, see “Operations-Related Table” on page 109.</p>	Operation	Availability (%)	Ser...ult	~2	fin...Ssn	100	getRecord	100	get...ary	100	Che...dit	100
Operation	Availability (%)												
Ser...ult	~2												
fin...Ssn	100												
getRecord	100												
get...ary	100												
Che...dit	100												
<p><b>Most Active Operations</b></p>	<p>Displays the five operations with the highest number of calls, during the selected time frame of the report. Each tab represents the total number of calls to the operation.</p> <div data-bbox="582 1058 1200 1348" data-label="Figure"> <table border="1"> <caption>Most Active Operations Data</caption> <thead> <tr> <th>Operation</th> <th># of Calls</th> </tr> </thead> <tbody> <tr> <td>Doc...ion</td> <td>~60,000</td> </tr> <tr> <td>Discover</td> <td>~10,000</td> </tr> <tr> <td>Ser...ult</td> <td>~5,000</td> </tr> <tr> <td>getRecord</td> <td>~5,000</td> </tr> <tr> <td>get...ary</td> <td>~5,000</td> </tr> </tbody> </table> </div> <p>This graph is displayed if you have selected the Operations report granularity. For details about the table columns, see “Operations-Related Table” on page 109.</p>	Operation	# of Calls	Doc...ion	~60,000	Discover	~10,000	Ser...ult	~5,000	getRecord	~5,000	get...ary	~5,000
Operation	# of Calls												
Doc...ion	~60,000												
Discover	~10,000												
Ser...ult	~5,000												
getRecord	~5,000												
get...ary	~5,000												

GUI Element (A-Z)	Description												
<p><b>Operations with Most Errors</b></p>	<p>Displays the five <b>operations</b> with the largest number of calls with errors, during the selected time frame of the report. Each tab represents the total number of errors received by the <b>operation</b>.</p> <div data-bbox="621 355 1235 642" data-label="Figure"> <table border="1"> <caption>Operations with Most Errors</caption> <thead> <tr> <th>Operation</th> <th># of Errors</th> </tr> </thead> <tbody> <tr> <td>Ser...ult</td> <td>~1,000</td> </tr> <tr> <td>fin...Ssn</td> <td>~50</td> </tr> <tr> <td>getRecord</td> <td>~50</td> </tr> <tr> <td>get...ary</td> <td>~50</td> </tr> <tr> <td>Che...dit</td> <td>~50</td> </tr> </tbody> </table> </div> <p>This graph is displayed if you have selected the Operations report granularity. For details about the table columns, see “Operations-Related Table” on page 109.</p>	Operation	# of Errors	Ser...ult	~1,000	fin...Ssn	~50	getRecord	~50	get...ary	~50	Che...dit	~50
Operation	# of Errors												
Ser...ult	~1,000												
fin...Ssn	~50												
getRecord	~50												
get...ary	~50												
Che...dit	~50												
<p><b>Operations with Most Slow Calls</b></p>	<p>Displays the five operations with the highest number of slow calls, in the selected time frame of the report. A slow call is defined as a call that lasts longer than a predefined threshold. Each tab represents the total number of slow calls received by the operation.</p> <div data-bbox="621 1024 1235 1310" data-label="Figure"> <table border="1"> <caption>Operations With Most Slow Calls</caption> <thead> <tr> <th>Operation</th> <th># of Slow Calls</th> </tr> </thead> <tbody> <tr> <td>fin...ild</td> <td>~1</td> </tr> <tr> <td>fin...Ssn</td> <td>~0.1</td> </tr> <tr> <td>getRecord</td> <td>~0.1</td> </tr> <tr> <td>get...ary</td> <td>~0.1</td> </tr> <tr> <td>Che...dit</td> <td>~0.1</td> </tr> </tbody> </table> </div> <p>This graph is displayed if you have selected the Operations report granularity. For details about the table columns, see “Operations-Related Table” on page 109.</p>	Operation	# of Slow Calls	fin...ild	~1	fin...Ssn	~0.1	getRecord	~0.1	get...ary	~0.1	Che...dit	~0.1
Operation	# of Slow Calls												
fin...ild	~1												
fin...Ssn	~0.1												
getRecord	~0.1												
get...ary	~0.1												
Che...dit	~0.1												

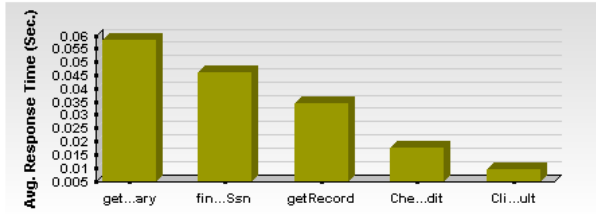
GUI Element (A-Z)	Description												
<p><b>Slowest Operations</b></p>	<p>The Slowest Operations graph displays the five slowest operations in the selected time frame of the report. A slow operation is defined as having the longest response time (no matter the threshold value). Each tab represents the average of the response times for the operation during the time frame of the report.</p> <div data-bbox="579 442 1196 730" style="border: 1px solid black; padding: 5px;"> <p style="text-align: center; margin: 0;">Slowest Operations</p>  <table border="1" style="margin: 5px auto; border-collapse: collapse;"> <caption>Data for Slowest Operations Graph</caption> <thead> <tr> <th>Operation</th> <th>Avg. Response Time (Sec.)</th> </tr> </thead> <tbody> <tr> <td>get...ary</td> <td>~0.058</td> </tr> <tr> <td>fin...Ssn</td> <td>~0.045</td> </tr> <tr> <td>getRecord</td> <td>~0.035</td> </tr> <tr> <td>Che...dit</td> <td>~0.018</td> </tr> <tr> <td>Cli...ult</td> <td>~0.008</td> </tr> </tbody> </table> </div> <p>This graph is displayed if you have selected the Operations report granularity.</p> <p>For details about the table columns, see “Operations-Related Table” on page 109.</p>	Operation	Avg. Response Time (Sec.)	get...ary	~0.058	fin...Ssn	~0.045	getRecord	~0.035	Che...dit	~0.018	Cli...ult	~0.008
Operation	Avg. Response Time (Sec.)												
get...ary	~0.058												
fin...Ssn	~0.045												
getRecord	~0.035												
Che...dit	~0.018												
Cli...ult	~0.008												

## Operations-Related Table

The Least Active Operations, Slowest Operations, Operations with Most SOAP Faults, Operations with Most Slow Calls, Most Active Operations, or Least Active Operations tables includes the following elements:

GUI Element (A-Z)	Description
# of Calls	The total number of calls to the specific operation during the selected time frame of the report.
# of Errors	<p>The number of calls to the specific operation, during the selected time frame of the report, that failed due to the unavailability of the operation.</p> <p><b>Configurable:</b> The SOAP faults affecting the availability can be configured in HP Diagnostics when the call is monitored by HP Diagnostics.</p>
# of Slow Calls	<p>The number of slow calls to the specific operation during the selected time frame of the report. A slow call is a call with a response time that is longer than a predefined threshold.</p> <p><b>Note:</b> The value displayed by # of Slow Calls is different from the value of the <b>Total Threshold Violation</b> in HP Diagnostics. In HP Diagnostics the <b>Total Threshold Violation</b> includes the overall number of violation from all the calls and in HP Business Availability Center # of Slow Calls includes only the violations of the successful calls.</p>
# of SOAP Faults	<p>The total number of SOAP faults that occurred in calls by the specific consumer.</p> <p>The column is displayed only when you select the <b>Real</b> data type.</p>
Availability (%)	The average availability of the operation during the selected time frame of the report. The availability is calculated as the number of successful calls to the operation, divided by the total number of calls to the operation, and multiplied by 100.

GUI Element (A-Z)	Description
<b>Avg. Response Time (sec.)</b>	The average response time (in seconds) of the operation during the selected time frame of the report.
<b>Name</b>	The name of the operation.
<b>NameSpace</b>	The name space of the Web service that runs the operation.
<b>Web Service</b>	The name of the Web service that runs the operation.

## Troubleshooting and Limitations

The SOA reports reflect the relative view of the user. Therefore, if in a customized view, specific operations are attached to a Web service, the SOA reports based on the view display information related only to the Web service and the selected operations. Other operations connected to the Web service in the CMDB are not displayed.

If the monitors attached to the operations are not added to the customized view, the SOA reports display information that does not take into consideration the thresholds defined in the monitors.

# Part II

---

## HP Business Availability Center for SAP Applications





# 2

---

## HP Business Availability Center for SAP Applications

This chapter includes information about deploying HP Business Availability Center for SAP Applications solution.

### **This chapter includes:**

#### Concepts

- HP Business Availability Center for SAP Applications – Overview on page 114
- HP Business Availability Center for SAP Applications License on page 115
- HP Business Availability Center for SAP Applications Architecture on page 116
- Business Process Monitor Measurements in SAP Systems View – Details on page 118
- SiteScope Measurements in SAP Systems View on page 124
- SAP Systems View on page 126
- SAP Service on page 129
- Collecting SAP System Information on page 130
- CCMS Counters on page 131

#### Tasks

- Deploy HP Business Availability Center for SAP Applications on page 133
- Deploy the SAP CCMS Monitor to Retrieve Measurements from the SAP System on page 135
- Activate the SAP Service on page 140

- ▶ Install HP Business Availability Center for SAP Applications on page 141
- ▶ Create Monitors on page 146
- ▶ Use a Business Process Monitor Profile to Simulate SAP Users on page 147
- ▶ Display SAP Information in Dashboard on page 154

#### Reference

- ▶ Default CIs in the SAP Systems View on page 155
- ▶ SAP-Related KPIs on page 159
- ▶ SAP-Related Menu Options on page 160
- ▶ HP Business Availability Center for SAP Applications User Interface on page 160
- ▶ Troubleshooting and Limitations on page 172

## **HP Business Availability Center for SAP Applications – Overview**

The HP Business Availability Center for SAP Applications, integrating SiteScope, Business Process Monitor, and HP Universal CMDB enables you to gain visibility and control over your mission-critical SAP systems and applications.

The SAP solution provides:

- ▶ A single operation console consolidating all SAP monitoring information.
- ▶ Automatic discovery and modeling of SAP-related elements, as well as their relations to other systems in the organization's IT.
- ▶ Change discovery and notification, for quicker problem resolution.
- ▶ Display of transport deployment impact, for move-to-production risk analysis.
- ▶ Proactive monitoring of end-user experience in SAP systems.
- ▶ A bridge between IT and line-of-business people using SAP Solution Manager business processes hierarchy monitoring.

- ▶ The ability to distinguish between SAP-specific problems and general ones.
- ▶ Examination, over time, of SAP CCMS monitoring data.
- ▶ Service Level Management of SAP systems' service level commitments.

In addition, you can create SLAs centered around your HP Business Availability Center for SAP Applications SAP transaction CIs to gain visibility into performance or availability issues that affect these SLAs. For details about SLAs, see “Service Level Management - Overview” in *Using Service Level Management*.

## **HP Business Availability Center for SAP Applications License**

The HP Business Availability Center for SAP Applications license unlocks the following functionality in HP Business Availability Center, helping to shorten time-to-value and minimize MTTR:

- ▶ The SAP Systems pattern view, displaying a hierarchical view of SAP applications and infrastructure.
- ▶ Automatic linkage of Business Process Monitor transactions to the SAP transactions they are monitoring.
- ▶ Automatic linkage of SiteScope measurements to their respective SAP infrastructure.
- ▶ SAP-specific KPIs that allow differentiation between SAP-related issues and non-SAP ones.
- ▶ **Show Impact** and **Problem Isolation** access from the Dashboard for quick visualization of change impact.
- ▶ SAP-specific change reports, summarizing the impact transports have on transactions in the SAP system.

## HP Business Availability Center for SAP Applications Architecture

The architecture of HP Business Availability Center for SAP Applications is illustrated in the following diagram:

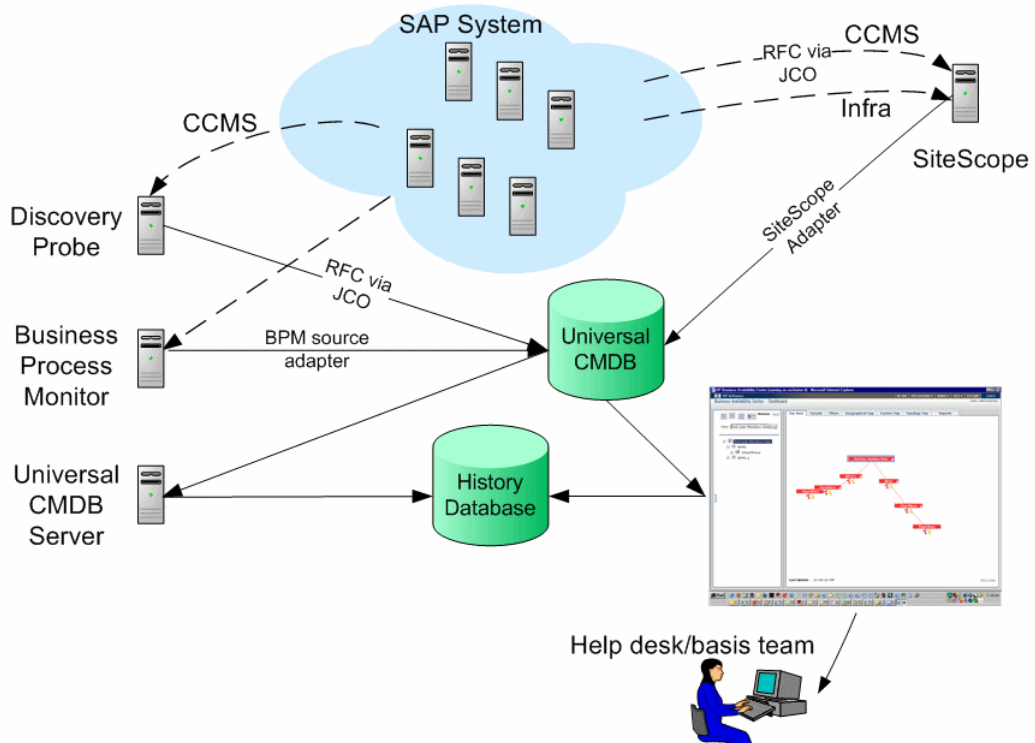

Most of the SAP CIs are created by automatic discovery. The configuration for these CIs is saved into the CMDB. Some of the relationships to Business Process Monitor and SiteScope CIs are created by automatic mechanisms unique to HP Business Availability Center for SAP Applications.

The architecture of HP Business Availability Center for SAP Applications includes the following components:

- ▶ The DDM Probe discovers SAP-related entities and the general entities (such as hosts) that are related to them using CCMS. The DDM Probe communicates with the CMDB using a Remote Function Call (RFC) with a Java Connector (JCo).
- ▶ SiteScope SAP CCMS Solution Set communicates with the SAP system and retrieves CCMS monitoring data using a Remote Function Call (RFC) with a Java Connector (JCo).
- ▶ Business Process Monitor collects data on the performance and availability of Business Process Monitor transactions carried out on the SAP system.
- ▶ HP Universal CMDB Server collects change information from the CMDB and stores it in the History database.
- ▶ Dashboard tabs and reports are used as the central console for viewing all of the data and performing analysis of the data. For details, see “Introduction to Dashboard” in *Using Dashboard*.

## Business Process Monitor Measurements in SAP Systems View – Details

You can view the Business Process Measurement in the SAP Systems view in different locations in the SAP hierarchy.

### View Hierarchy When Adhering to the Naming Conventions for Business Process Steps and When Using the Transaction/Location Hierarchy Structure

If you have used the naming convention for the Business Process Step, and you have set the Hierarchy structure of the Business Process Monitoring source adapter to **Transaction/Location** then the view displays the following structure:

- ▶ The BPM Monitor (BPM transaction from location CIT) is displayed under a Business Process Step CI, under a SAP Transaction CI, under several levels of SAP Application Component CIs, under a SAP System CI. For example:

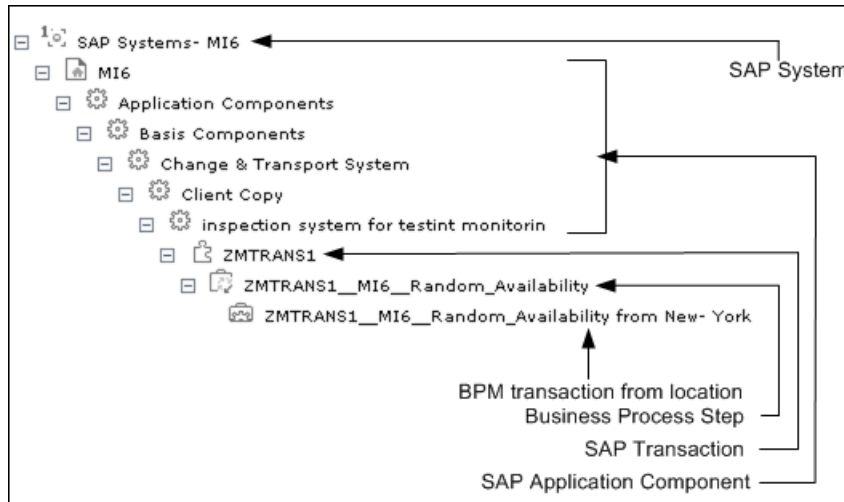

- ▶ The BPM Monitor (BPM transaction from location CIT) is also displayed under a Business Process Step CI under the Contained group CI (Business Processes). For example:

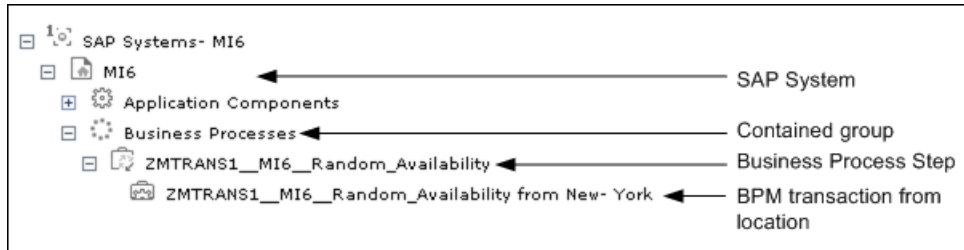

- ▶ The BPM Monitor (BPM transaction from location CIT) is displayed under a Contained Location CI itself under a Contained group CI (Locations) under the SAP System CI. For example:

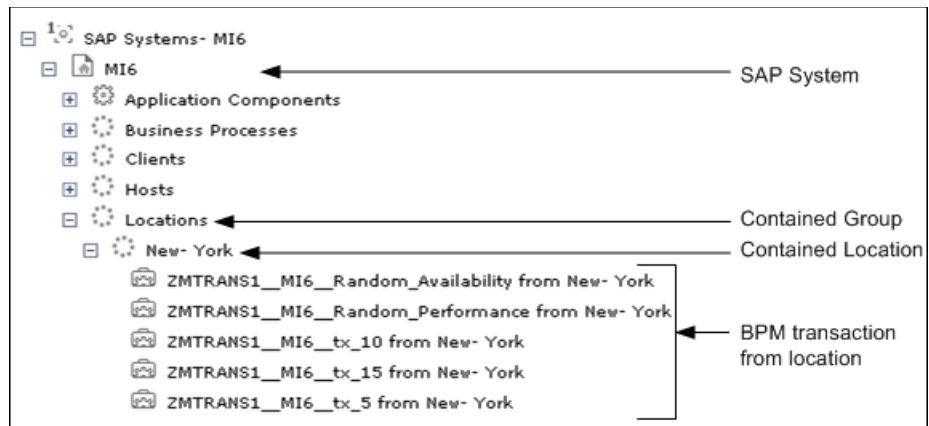

For details on the types of hierarchy, see “New/Edit Source Adapter Dialog Box” in *Model Management*.

## View Hierarchy When Not Adhering to Naming Convention for Business Process Steps and When Using the Transaction/Location Hierarchy Structure

If the Business Process Steps do not follow the naming conventions, and you have set the Hierarchy structure of the Business Process Monitoring source adapter to **Transaction/Location**, then the view displays the following structure:

- ▶ The BPM Monitor (BPM transaction from location CIT) is displayed under a Business Process Step CI, under a SAP Transaction CI, under several levels of SAP Application Component CIs, under a SAP System CI. For example:

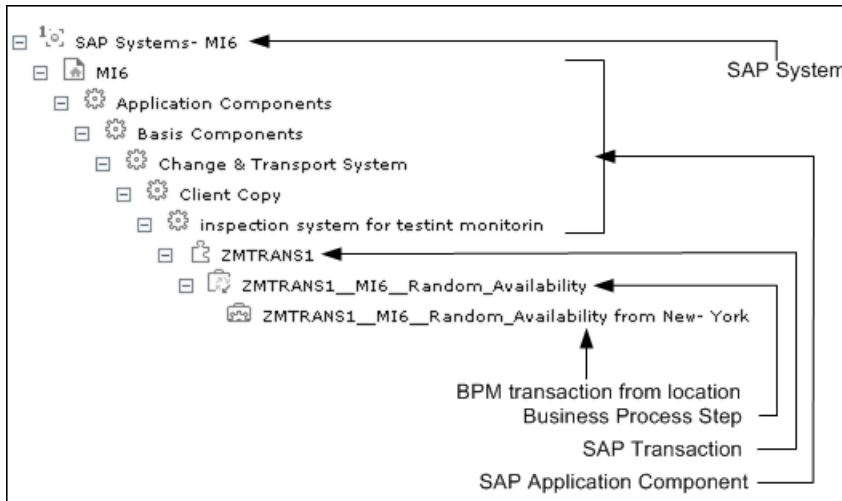



- ▶ The BPM Monitor (BPM transaction from location CIT) is also displayed under a Business Process Step CI under the Contained group CI (Business Processes). For example:

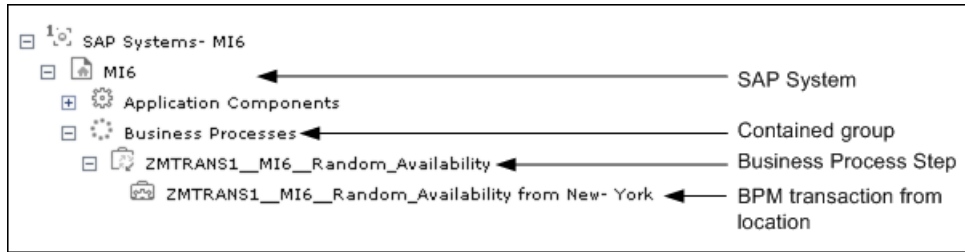

- ▶ The BPM Monitor (BPM transaction from location CIT) is also displayed under a Contained Location CI, under a Contained group CI (Locations), under a SAP System CI. For example:

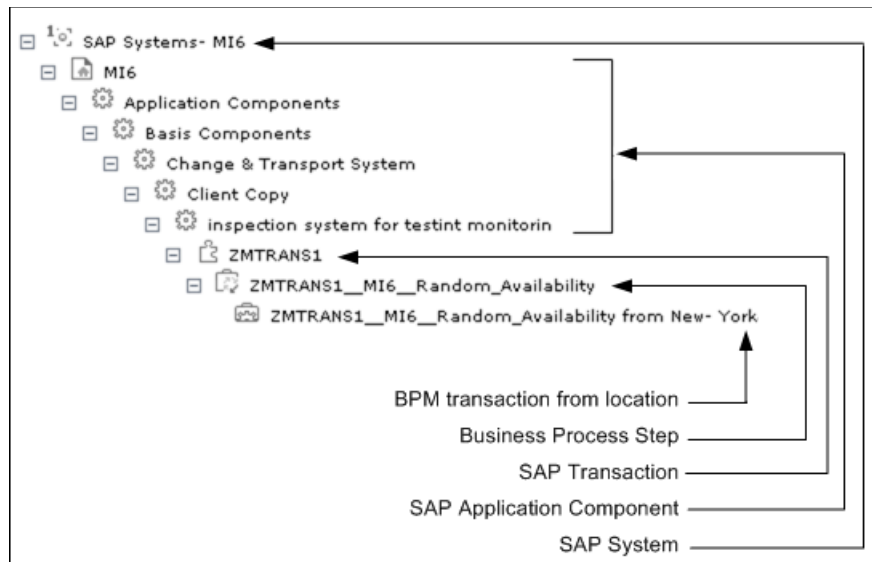

For details on the types of hierarchy, see “New/Edit Source Adapter Dialog Box” in *Model Management*.

## View Hierarchy When Adhering to Naming Conventions for Business Process Steps and Regular Hierarchy Structure

If the Business Process Steps follow the naming conventions and you have set the Hierarchy structure of the Business Process Monitoring source adapter to **Regular**, then the view displays the following structure:

- The BPM Monitor (BPM transaction from location CIT) is displayed without the location information, under a Business Process Step CI, under a SAP Transaction CI, under several levels of SAP Application Component CIs, under a SAP System CI. For example:

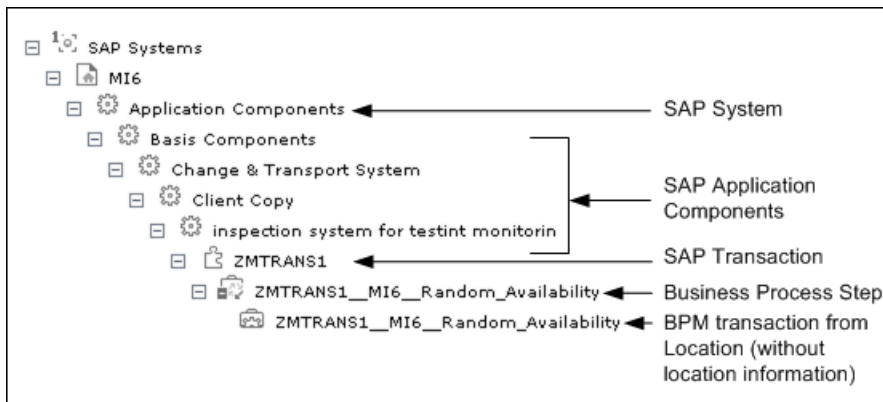

- The BPM Monitor (BPM transaction from location CIT) without location information, is also displayed under a Business Process Step CI under the Contained group CI (Business Processes). For example:

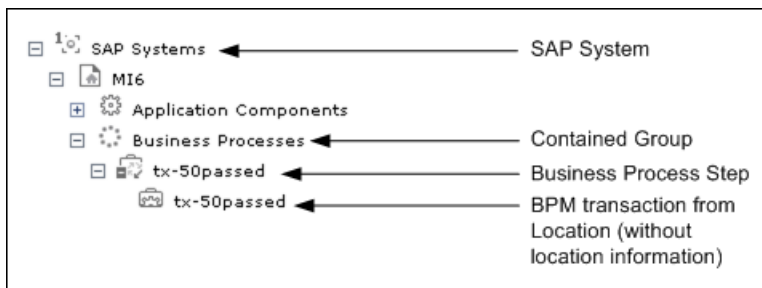

## View Hierarchy When Not Adhering to the Naming Convention for Business Process Steps and Regular Hierarchy Structure

If a Business Process Step does not follow the naming conventions and you have set the Hierarchy structure of the Business Process Monitoring source adapter to **Regular**, then the view displays the following structure:

- The BPM Monitor (BPM transaction from location CIT) is displayed under a Business Process Step CI, under a SAP Transaction CI, under several levels of SAP Application Component CIs, under a SAP System CI, without the location information. For example:

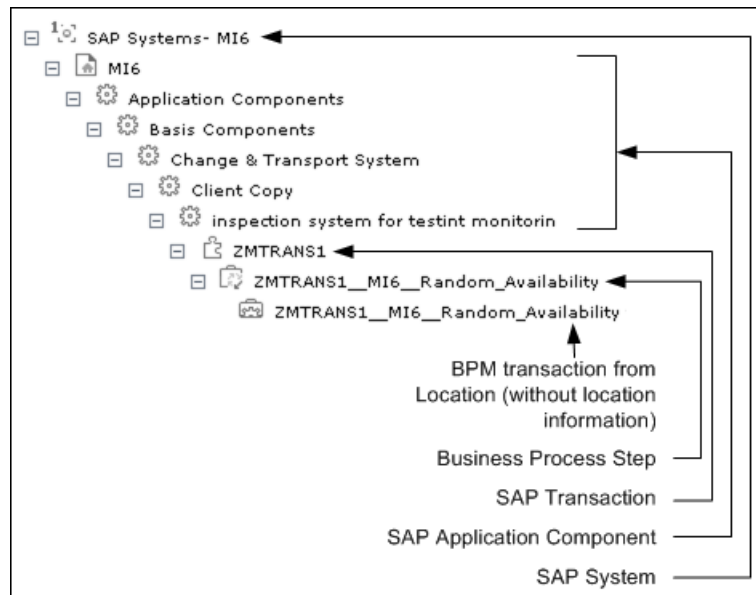

- The BPM Monitor (BPM transaction from location CIT) without location information, is also displayed under a Business Process Step CI under the Contained group CI (Business Processes). For example:

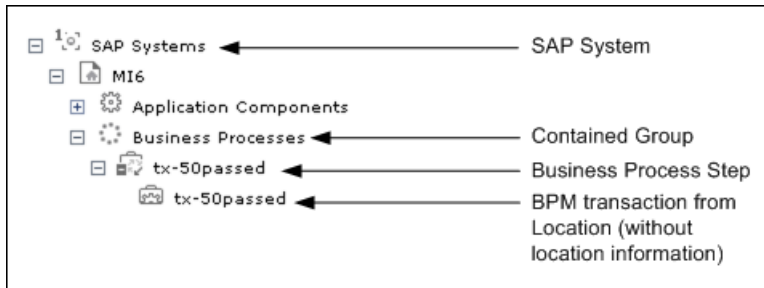

For details on the types of hierarchy, see “New/Edit Source Adapter Dialog Box” in *Model Management*.

## SiteScope Measurements in SAP Systems View

SiteScope monitors are displayed in the SAP Systems view only if they are linked to hosts. To display them elsewhere in the hierarchy, advanced users must modify the TQL of the SAP System.

- The SiteScope Measurement is displayed under a SAP Work Process CI, under SAP R/3 Application Server CI, under an instance of a Contained Group CI, under a SAP System CI. For example:

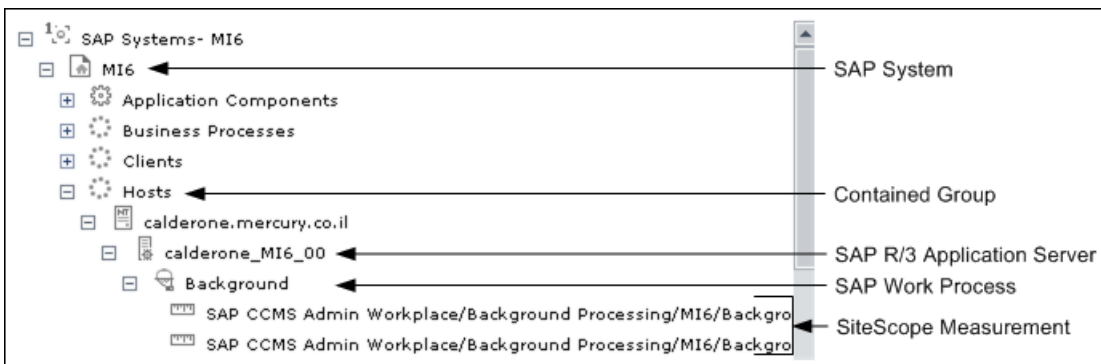

- The SiteScope Measurement is displayed under a SAP R/3 Application Server CI, under an instance of a Contained Group CI, under a SAP System CI. For example:

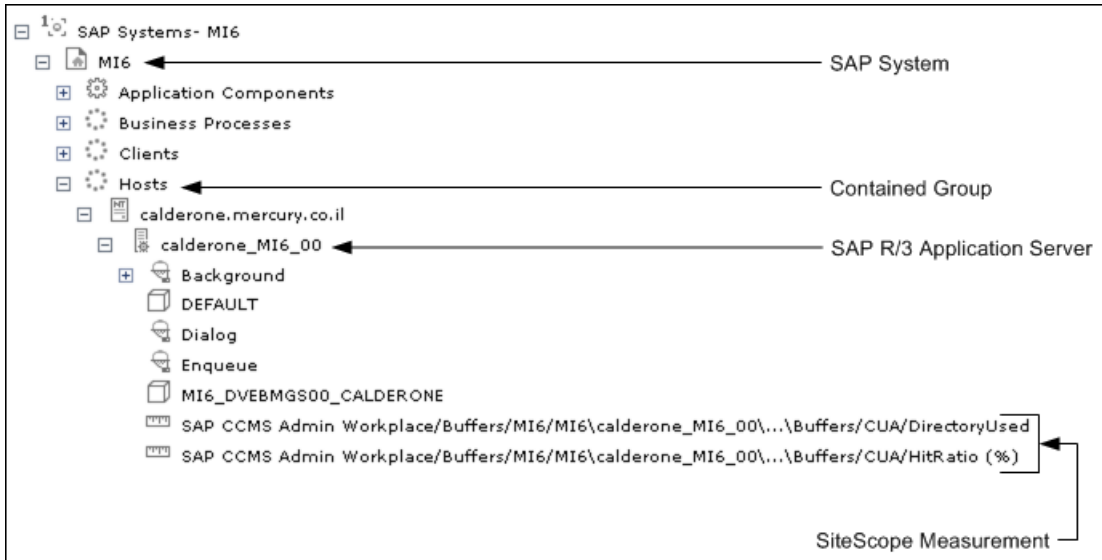

- The SiteScope Measurement is displayed under a SAP System CI. For example:

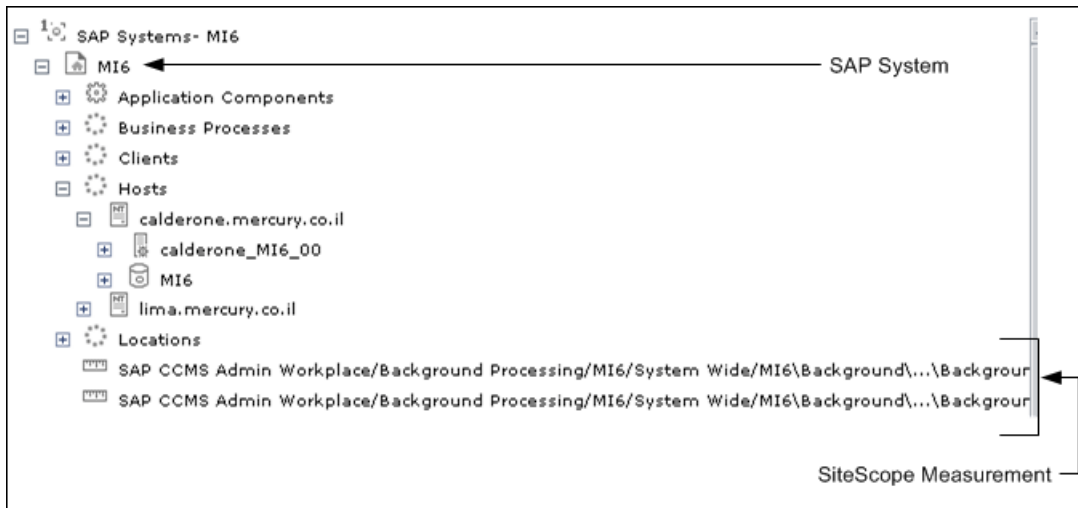

- ▶ The SiteScope Measurement is displayed under a Database CI, under an instance of a Contained Group CI, under a SAP System CI. For example:

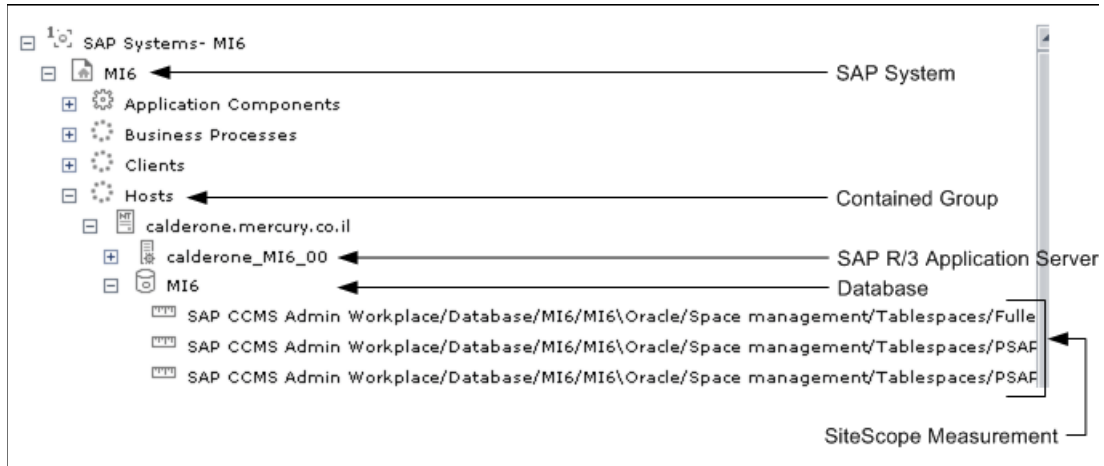

## SAP Systems View

You can view SAP information in the SAP Systems view in Dashboard. For details about how to work with the Console tab, see “Console Page” in *Using Dashboard*.

The SAP Systems view in View Explorer appears as follows:

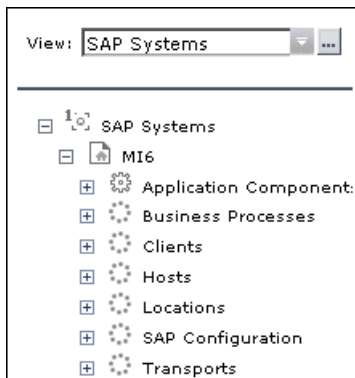

The following graph describes the various layers and drill-downs available in the topology of the SAP Systems view:

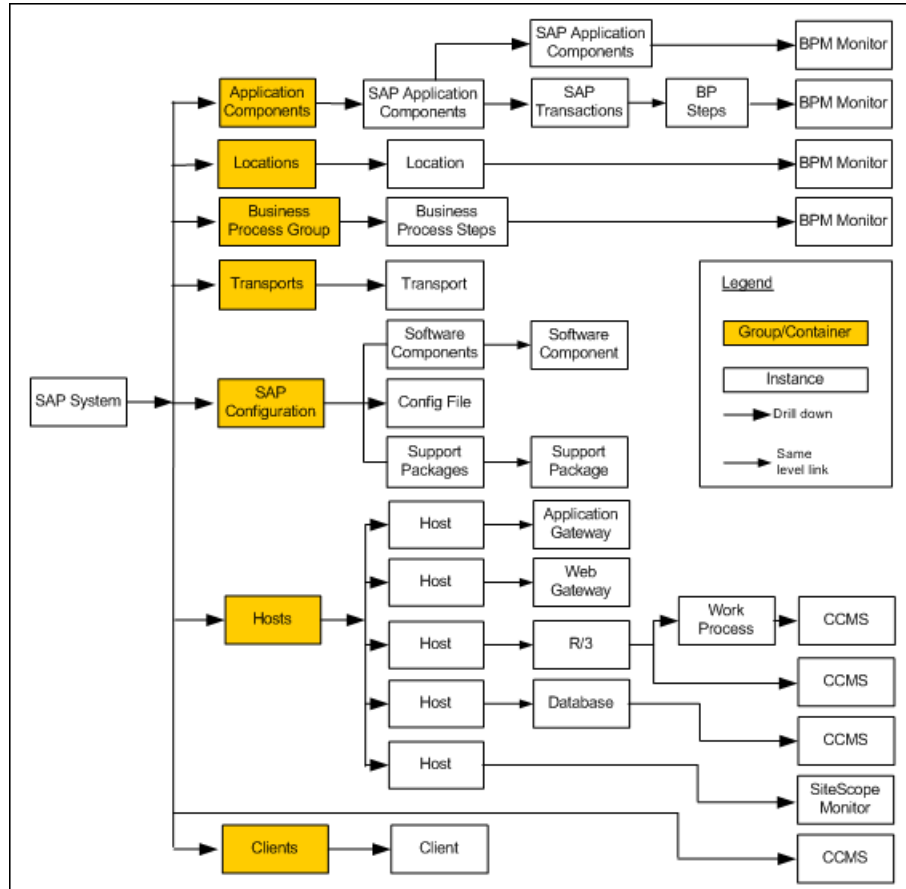

## Topologies

In addition, the SAP Systems view includes the following topologies, which are created by specific SiteScope monitors:

► **SAP CCMS topology discovered by SiteScope:**

SiteScope creates the following topology for the SiteScope SAP CCMS monitor. The CIs are created only for the monitored entities according to the counters that you selected.

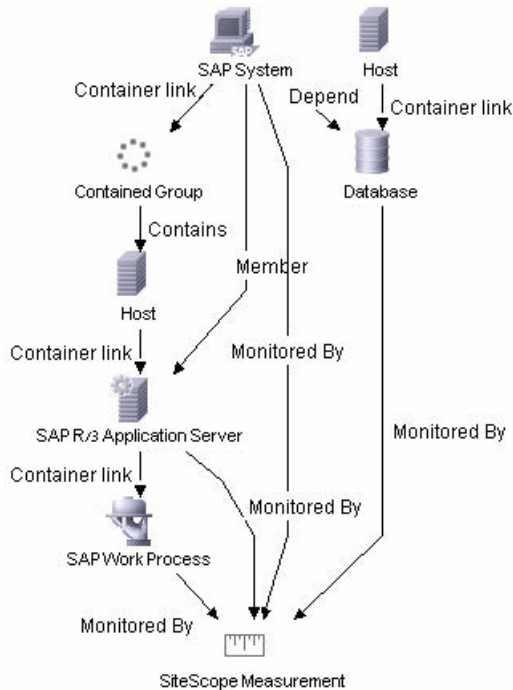

---

**Note:** The Database CI is always a child of the Host CI that you specified in the monitor definition even if it is actually running on another host.

---



► **SAP Work Processes topology discovered by SiteScope:**

SiteScope creates the following topology for the SiteScope SAP Work Processes monitor. The CIs are created only for the monitored entities according to the counters that you selected.

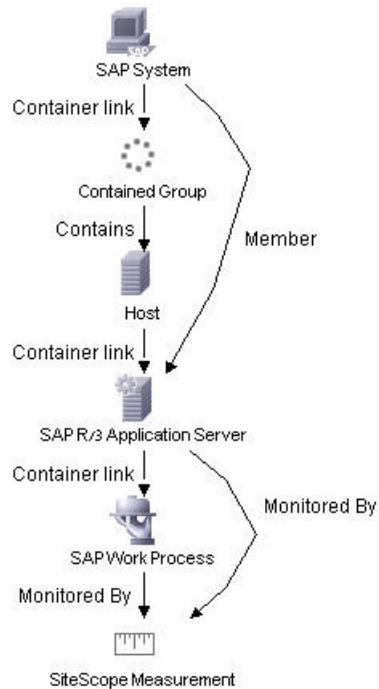

## SAP Service

The SAP service is assigned to the Modeling Data Processing Server. It is a configuration service that enables HP Business Availability Center to work with data that is in SAP format.

For details about how to view a service status using the JMX Web console, see “High Availability for the Data Processing Server” in the *HP Business Availability Center Deployment Guide* PDF.

The SAP Service is responsible for the following advantages:

- ▶ Intelligent relation of monitoring information.
- ▶ Installation on the modeling processing server (5 server installation).
- ▶ Loading occurs after the CMDB and Viewing System services are loaded.
- ▶ Registration on 3 TQLs and notification on every change in each one of those TQLs.
- ▶ Check of the service activity in the JMX console. For details, see “Activate the SAP Service” on page 140.
- ▶ Automatic linkage of SiteScope measurements or BPM scripts with standardized names. For details, see “Follow the Naming Conventions for Naming Business Process Steps” on page 150.
- ▶ Creation of Business Process and Locations container and connection of the appropriate Business Process Steps to the containers. A Business Process Step connected manually to the SAP transaction would also be connected to these containers. For details, see “Attach Business Process Steps to a SAP Transaction without Following the Naming Conventions” on page 151.
- ▶ Works after the BPM source adapter and SiteScope source adapters (when you are working with SiteScope 9.0) have been synchronized.

## **Collecting SAP System Information**

The Automatic Discovery component discovers the actual SAP IT entities and stores them as CIs in the CMDB.

All configuration actions of SAP CIs are performed inside the CMDB Administration application. All SAP CIs appear in the SAP Systems view under a root CI called SAP Systems.

All SAP system metrics are monitored by SiteScope monitors.

SAP business processes/transactions are simulated using Business Process Monitor pre-recorded VUGen scripts. Each script includes one or more Business Process Steps and are executed from a specific location. All Business Process Monitor-related CIs are stored in the CMDB as non-SAP-related CIs with links to the appropriate SAP-related CIs.

Information about the SAP System is available in Dashboard in all of the relevant tabs like other information.

The SAP Systems views includes information from the SAP IT entities, SAP system metrics monitored by SiteScope monitors, and information about the SAP business processes/transactions simulated by Business Process Monitor scripts.

## CCMS Counters

The CCMS Counters Dynamic Nodes collect the samples from SiteScope and display them as CIs under the elements they are monitoring.

To view these CIs, select **Applications > Dashboard**, click **Console**, select **SAP Systems** in the **View** list, and click **Background**.

The Console page displays the samples from SiteScope.

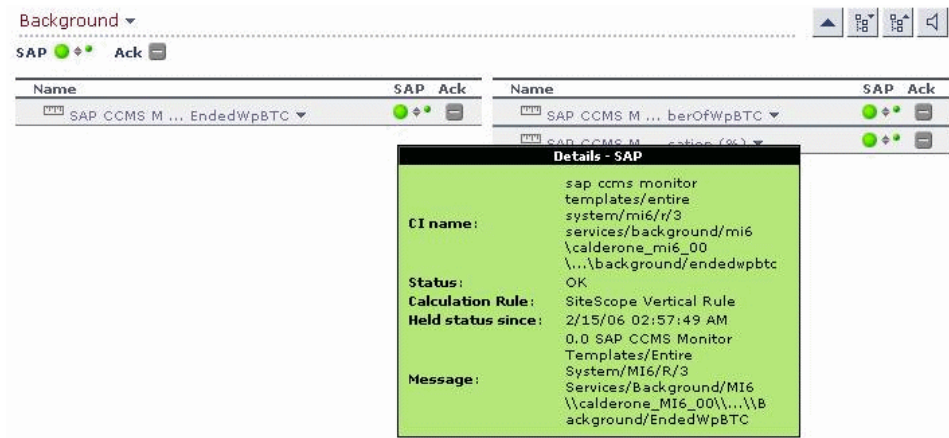

The screenshot shows the 'Background' console view in SiteScope. It displays a table of CIs with columns for Name, SAP status, and Ack. A detailed view for a specific CI is shown below the table.

Name	SAP	Ack
SAP CCMS M ... EndedWpBTC	OK	
SAP CCMS M ... berOfWpBTC	OK	
SAP CCMS M ... enties (%)	OK	

Details - SAP	
<b>CI name:</b>	sap_ccms_monitor templates/entire system/mi6/r/3 services/background/mi6 \\calderone_mi6_00 \\...\\background/endedwpbtc
<b>Status:</b>	OK
<b>Calculation Rule:</b>	SiteScope Vertical Rule
<b>Held status since:</b>	2/15/06 02:57:49 AM
<b>Message:</b>	0.0 SAP CCMS Monitor Templates/Entire System/MI6/R/3 Services/Background/MI6 \\calderone_MI6_00\\...\\B ackground/EndedWpBTC

Move the mouse over the CI to display a tooltip that provides information about the CI, its status, the rule that calculates the status of the SAP KPI, the values returned by the monitor the last time it ran, the measurement names, and the monitor type. The tooltip includes the following information:

- **CI Name.** The name of the CI.
- **Status.** The status of the CI (calculated according to one of the status calculation methods). It may also display:
  - **Not up to date** for decayed CIs, indicating that the CI has passed its timeout period. (For a SiteScope CI, this status is displayed after a SiteScope monitor is disabled.)
  - **Stopped** when a Business Process profile is stopped.
- **Calculation Rule.** The name of the rule that calculates the KPI status or value.
- **Held Status Since.** The date and time since which this CI has held its current operational status.
- **Message.** The values returned by the monitor the last time it ran, as displayed in SiteScope. This may simply be the retrieval time and file size or it may include specific parameters for a server component.
- **Last Update.** The date and time that the last update for the CI was received by Dashboard. This information is not always displayed.
- **Measurement.** The name of the measurement from SiteScope. This information is not always displayed.
- **Monitor.** The monitor type that the CI represents. This information is not always displayed.

## Deploy HP Business Availability Center for SAP Applications

This section describes the processes to follow to display SAP information in Dashboard, and gives examples.

This task includes the following steps:

- “Prerequisites” on page 133
- “Install HP Business Availability Center for SAP Applications” on page 134
- “Run SAP Discovery” on page 134
- “Create a Business Process Monitor Profile” on page 134
- “Create Monitors” on page 134
- “Modify SiteScope KPI Assignment Group” on page 134
- “Display SAP Information in Dashboard” on page 135
- “Add an Application Server to the SAP System” on page 135

### 1 Prerequisites

Ensure that the following software is installed before you install the SAP solution:

- **DDM Probe.** Used to perform the discovery of SAP topology in your organization. For details, see “Discovery and Dependency Mapping” in *Discovery and Dependency Mapping Guide*.
- **SiteScope.** Used to integrate the SiteScope data collector into the HP Business Availability Center for SAP Applications solution. For details, see the *HP SiteScope Deployment Guide* PDF.
- **Business Process Monitor.** Used to integrate the Business Process Monitor data into the HP Business Availability Center for SAP Applications solution. For details, see “Introducing Business Process Monitor” in *HP Business Process Monitor Administrator’s Guide*.

**Note:** You must have a SAP license to view the SAP Systems view in HP Business Availability Center.

---

## **2 Install HP Business Availability Center for SAP Applications**

Install HP Business Availability Center for SAP Applications.

For details, see “Install HP Business Availability Center for SAP Applications” on page 141.

## **3 Run SAP Discovery**

You can run SAP discovery to discover SAP elements and SAP topology. For details, see “SAP Discovery” in *Discovery and Dependency Mapping Guide*.

## **4 Create a Business Process Monitor Profile**

Business Process Monitor profiles are used to simulate SAP users to obtain performance and availability information on the SAP transactions.

For details, see “Use a Business Process Monitor Profile to Simulate SAP Users” on page 147.

## **5 Create Monitors**

You can create a SAP CCMS monitor and general SiteScope monitors to get the complete picture: Database Query Monitor, Ping Monitor, and so on. For details, see “Create Monitors” on page 146.

## **6 Modify SiteScope KPI Assignment Group**

If required, when you are working with SiteScope 9.50, you can modify the existing SiteScope KPI assignments. For details, see “Assignment Groups Page” in *Using Dashboard*.

## 7 Display SAP Information in Dashboard

You can display SAP information in Dashboard in different views and reports. For details, see “Display SAP Information in Dashboard” on page 154.

## 8 Add an Application Server to the SAP System

When you add a new application server to the SAP System, you must clear the **Report SAP Topology to HP Business Availability Center** option, save the Monitor definition, and then select the option again and save the monitor definition, in order for the monitor to recognize the new application server.

## Deploy the SAP CCMS Monitor to Retrieve Measurements from the SAP System

The SAP CCMS monitor retrieves and reports measurements from SAP's centralized monitoring system CCMS. CCMS is used to monitor all servers, components and resources in the SAP R/3® System from one single centralized server, facilitating problem discovery and problem diagnosis. For details, see “SAP CCMS Monitor Overview” in *Using System Availability Management*.

---

**Note:** The SAP CCMS Monitor is an optional SiteScope feature whose license is provided with the SAP solution.

---

This task includes the following steps:

- ▶ “Deploy a CCMS Monitor Using the SiteScope CCMS Solution Template” on page 136
- ▶ “Attach SiteScope to HP Business Availability Center” on page 137
- ▶ “Check That the Monitor Is Set to Report All Monitors and Measurements” on page 137

- “Synchronize the SiteScope Source Adapter” on page 137
- “Connect the SAP CCMS Measurements to the Appropriate Elements of the SAP Hierarchy” on page 138
- “Check/View the SiteScope Measurements in the SAP View” on page 140

## 1 Deploy a CCMS Monitor Using the SiteScope CCMS Solution Template

The **MonitorSetSSServer.mset** solution template is the most effective way to deploy a CCMS monitor.

To deploy a CCMS monitor using the SiteScope CCMS solution template:

- a** Access SiteScope using System Availability Management in HP Business Availability Center or directly using the URL: **http://<SiteScope\_server>:8080/<HP\_BAC\_web\_application\_context\_name (usually topaz)>/**.
- b** Select **Admin > System Availability Center**.
- c** Right-click the appropriate SiteScope in the Enterprise tree, and select **New Group**.
- d** Enter the name of the group in the **Group Name** box in the Main Settings area.
- e** Click **OK**.
- f** Expand **Solution Sets**, right-click **SAPR3Solution**, and select **Copy**.
- g** Right-click the new group you have created, and select **Paste**.
- h** In the Main Settings area, enter the following information:
  - The name of the SAP System in the **TARGET\_SERVER\_NAME** box.
  - The user name in the **USER\_NAME** box.
  - The password in the **Password** box.
  - The number of the SAP system in the **SYSTEM\_NUMBER** box.
  - The number of the client to which you connect SiteScope in the **CLIENT\_NUMBER** box.
- i** Click **OK**.



## 2 Attach SiteScope to HP Business Availability Center

Make sure that SiteScope is attached to HP Business Availability Center. For details, see “New SiteScope Page” in *Using System Availability Management*.

## 3 Check That the Monitor Is Set to Report All Monitors and Measurements

To view SiteScope measurements, you must check that the monitor is set to report all monitors and measurements information.

To check that the monitor is set to **Report All Monitors and Measurements**:

- a** Select **Admin > System Availability Center**.
- b** Double-click the appropriate CCMS monitor under the appropriate group, select **Properties**, and expand the HP Business Availability Center Login area.
- c** Check that the value of the **Logging to HP Business Availability Center** is set to **Report everything (all monitors and all measurements)**.

HP BAC Logging	
Logging to HP Business Availability Center	<input type="radio"/> Do not report to HP Business Availability Center
	<input checked="" type="radio"/> Report everything (all monitors and all measurements)
	<input type="radio"/> Report monitor level data (no measurements)
	<input type="radio"/> Report monitor level data and measurements with thresholds
	<input type="radio"/> Report status changes (no measurements)

## 4 Synchronize the SiteScope Source Adapter

If you are working with SiteScope 9.0, you can synchronize the SiteScope source adapter immediately or you can wait for the automatic synchronization to take place. For details, see “Source Manager Page” in *Model Management*.

## 5 Connect the SAP CCMS Measurements to the Appropriate Elements of the SAP Hierarchy

The SAP CCMS measurements are connected to the appropriate elements of the SAP hierarchy as follows:

- a** A SAP CCMS measurement can reside only under a System, R/3 Application Server, Work Process, or Database CIT.
- b** The linkage is performed based on the CCMS measurement's name that includes the name of the appropriate CI.

A CCMS measurement name has the following syntax: <field1>/<field2>/<field3>. If the fields in the CCMS name include the name of an R/3 Application Server, System ID, Work Process name, or Database name, the CCMS measurement is attached to the appropriate CI as follows:

<field1>	<field2>	<field3>	Attached to CI
R/3 Application Server name	System ID	Work Process name	Attached to the specified work process
R/3 Application Server name	System ID	N/A	Attached to the specified R/3 application server
System ID	N/A	N/A	Attached to the specified SAP system
System ID	Database name	N/A	Attached to the specified database

For more details about the SAP hierarchy, see “Default CIs in the SAP Systems View” on page 155.

## Example

If you have the following CCMS measurements, the first three CCMS measurements are attached to the Background CI (Work Process) under the R/3 Services CI (R/3 Application Server), under the Host CI, and the other group of measurements are attached to the Dialog Work Process under the R/3 Services (R/3 Application Server) under the Host calderone\_MI6\_00.

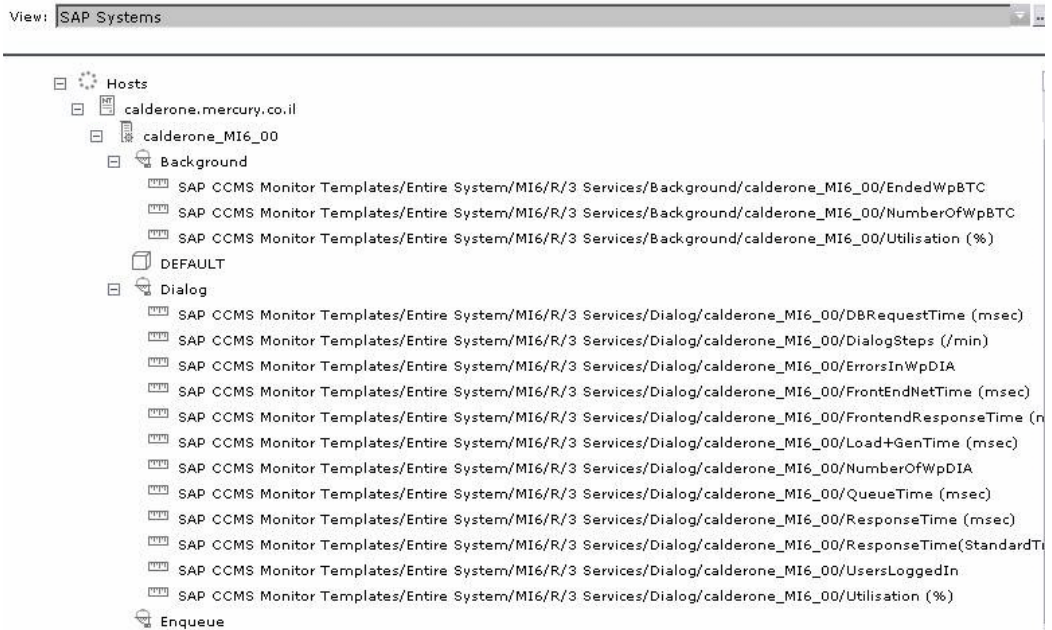

## 6 Check/View the SiteScope Measurements in the SAP View

SiteScope monitors are displayed in the SAP view only if they are connected to hosts. To display them elsewhere in the hierarchy, advanced users must modify the TQL of the SAP System. For details, see “SiteScope Measurements in SAP Systems View” on page 124.

---

**Note:** If SiteScope measurements names are too long and are truncated in Dashboard, you can change the CIT default label to **RegExp(data\_name, (.\*[/].\*[/].\*[/])(.\*),2)** instead of just **data\_name**. Only the beginning of the path and the last part of the measurement's name are displayed instead of the entire measurement name (including the path). If you change the CIT default label, you must also change all references in the code and in the TQL layout from **display\_label** to **data\_name**.

---

## Activate the SAP Service

Check that the SAP Service is activated (it is activated by default). If necessary, activate it manually. For details, see “High Availability for the Data Processing Server” in the *HP Business Availability Center Deployment Guide* PDF.

**To manually activate the SAP Service:**

- 1 In the browser, enter (using JMX login credentials):  
**http://<HP Business Availability Center server name>:8080/jmx-console/**
- 2 Double-click **service=Verticals External Enrichment Service** listed under **Topaz**.
- 3 The JMX MBean View for Verticals External Enrichment Service opens.

**4** Specify:

- **performLinkage.** The customer ID and the relevant linkage used to perform (CCMS/BPM AUTO/BPM manual).
- **createTqllListeners.** Use for debugging.
- **Start.** Starts the service.
- **Stop.** Stops the service.

## **Install HP Business Availability Center for SAP Applications**

---

**Note:** An existing Business Process Monitor machine can be leveraged for running SAP scripts as well.

---

Deploying the SAP solution includes setting the appropriate licenses, connecting SAP Java Connector on the SiteScope machine, and setting the DDM Probe.

This task includes the following steps:

- “Set the License for the SAP Solution” on page 142
- “Install the SAP Java Connector on the SiteScope Machine” on page 143
- “Set the SiteScope License” on page 143
- “Perform the DDM Probe Post-Installation Procedure” on page 144
- “Restart the Discovery Agent” on page 145

## 1 Set the License for the SAP Solution

Do the following:

► **Set the license for the SAP solution.**

Log in to HP Business Availability Center, select **Admin > Platform > Setup and Maintenance > License Management**. Click **New License Key** to open the New License Key page, and enter a valid license key in the **License key** box. The license key includes the SAP solution. Click **OK** to save the change. Verify that the value of **Business Availability Center for SAP** in the **Applications** area is **Licensed**. It is recommended to restart HP Business Availability Center at this point.

When setting the SAP solution license, verify that the license also contains the Auto Discovery license (customers with HP Business Availability Center for SAP license also receive the Auto Discovery license).

If the SAP solution license was set while installing HP Business Availability Center, the SAP jobs are automatically deployed and added to the CMDB.

If the SAP solution license was set after installing HP Business Availability Center, you must deploy the jobs manually or restart HP Business Availability Center so the SAP jobs are deployed automatically (this is the recommended procedure).

---

**Note:** The SAP-related jobs: SAP.zip, SAP\_discovery.zip, and SAP\_monitoring.zip are at the following location on the machine where CMDB is installed:  
<HP Business Availability Center root directory>\mam\_lib\packages.

---

► **Check that the jobs are deployed:**

Select **Admin > Universal CMDB > Modeling > It Universe Manager** and check that the SAP views are listed in the View list in View Explorer.

## 2 Install the SAP Java Connector on the SiteScope Machine

Once SiteScope is installed, install SAP Java connector on the SiteScope machine, as follows:

- a** Download the SAP JCo package from the Tools & Services window of SAP JCo in SAP Service Marketplace:  
[https://websmp101.sap-ag.de/~form/sapnet?\\_SHORTKEY=01100035870000463649](https://websmp101.sap-ag.de/~form/sapnet?_SHORTKEY=01100035870000463649)
- b** Extract **sapjco-ntintel-2.0.8.zip** to a temporary directory (for example, C:\temp) on the SiteScope machine.
- c** Copy **sapjco.jar** from the temporary directory to the **<SiteScope root directory>\SiteScope\WEB-INF\lib** directory on the SiteScope machine.
- d** Copy **sapjcorfc.dll** from the temporary directory to the **<SiteScope root directory>\SiteScope\bin** directory on the SiteScope machine.
- e** Copy **librfc32.dll** from the temporary directory, in the SiteScope machine to:
  - the **%winnt%\system32** directory
  - the **<SiteScope root directory>\SiteScope\bin** directory

If there is an old version of the **librfc32.dll** file already in the **<SiteScope root directory>\bin** or in the **%winnt%\system32** directory, you should replace it.
- f** Restart SiteScope as follows: on the SiteScope machine, go to **Start > Programs > Administration Tools > Services**, find SiteScope service and restart it.

## 3 Set the SiteScope License

To set the SiteScope license appropriate for your system:

- a** Launch SiteScope by entering the following URL in a browser:  
[http://<SiS\\_machine\\_name>:8080](http://<SiS_machine_name>:8080)
- b** Choose **Preferences > General Preferences**.
- c** Click **Edit**.
- d** Click **Insert valid license keys**.

- e** In the **License Number** box, enter a valid SiteScope license key.
- f** In the **Option Licenses** box, enter the SiteScope license keys appropriate for the SAP solution.  
  
Make sure to insert a license for: EMS monitors, SAP monitors, and the SAP R/3 solution template.
- g** Click **OK** to approve the changes.

#### 4 Perform the DDM Probe Post-Installation Procedure

After installing the DDM Probe, perform the post-installation procedure (see below) and restart the DDM Probe. If the DDM Probe is already running before you perform the post-installation procedure, stop it and restart it afterwards.

To perform the DDM Probe post-installation:

- a** Download the SAP JCo package from the Tools & Services window of SAP JCo in SAP Service Marketplace:  
[https://websmp101.sap-ag.de/~form/sapnet?\\_SHORTKEY=01100035870000463649](https://websmp101.sap-ag.de/~form/sapnet?_SHORTKEY=01100035870000463649)
- b** Extract **sapjco-ntintel-2.0.8.zip** to a temporary directory (for example: C:\temp) on the HP Business Availability Center machine.
- c** Create a new **sap** directory (in lowercase) in the **<HP Business Availability Center root directory>** **\DiscoveryProbe\root\ext\** directory on the machine where the DDM Probe is installed.
- d** Copy **sapjco.jar** from the temporary directory to the **<HP Business Availability Center root directory>** **\DiscoveryProbe\root\ext\sap\** directory on the machine where the DDM Probe is installed.
- e** Copy **sapjcorfc.dll** from the temporary directory to the **<HP Business Availability Center root directory>** **\DiscoveryProbe\root\ext\sap\** directory on the machine where the DDM Probe is installed.
- f** Copy **librfc32.dll** from the temporary directory to the **%winnt%\system32** directory.



- g Verify that the `MSVCR71.dll` and `MSVCP71.dll` files are located in the `%windnt%\system32` directory.

## 5 Restart the Discovery Agent

Use the following steps:

- a On the DDM Probe machine, access: **Start > Programs > Business Availability Center > Administration > Discovery Agent**
- b This starts the DDM Probe and opens a CMD console.
- c Wait until the console displays the following lines: **Finished startup sequence**

```

Discovery Agent
jvm 1      | <2005-07-12 19:11:15,643> 4391 [INFO ] [WrapperSimpleAppMain] <ProbeT
asksDistributorPull.java94> - Pull tasks distributor has started successfully
jvm 1      | <2005-07-12 19:11:15,643> 4391 [INFO ] [WrapperSimpleAppMain] <ProbeD
ownLoader.java89> - The Probe DownLoader has started successfully
jvm 1      | <2005-07-12 19:11:16,408> 5156 [INFO ] [WrapperSimpleAppMain] <Domain
ScopeManager.java23> - reloading document domainScopeDocument
jvm 1      | <2005-07-12 19:11:16,408> 5156 [INFO ] [WrapperSimpleAppMain] <Domain
ScopeManager.java47> - processing document domainScopeDocument
jvm 1      | <2005-07-12 19:11:16,440> 5188 [INFO ] [ThreadService-0] <DomainScope
Manager.java23> - reloading document domainScopeDocument
jvm 1      | <2005-07-12 19:11:16,440> 5188 [INFO ] [ThreadService-0] <DomainScope
Manager.java47> - processing document domainScopeDocument
jvm 1      | <2005-07-12 19:11:16,471> 5219 [INFO ] [WrapperSimpleAppMain] <Protoc
oldictionaryManager.java65> - no domain_protocolist attribute for domain niceDo
main
jvm 1      | <2005-07-12 19:11:16,471> 5219 [INFO ] [WrapperSimpleAppMain] <Domain
ScopeManager.java63> - processing document domainScopeDocument is done!
jvm 1      | <2005-07-12 19:11:16,471> 5219 [INFO ] [ThreadService-0] <ProtocolDic
tionaryManager.java65> - no domain_protocolist attribute for domain niceDomain
jvm 1      | <2005-07-12 19:11:16,471> 5219 [INFO ] [ThreadService-0] <DomainScope
Manager.java63> - processing document domainScopeDocument is done!
jvm 1      | <2005-07-12 19:11:16,502> 5250 [INFO ] [WrapperSimpleAppMain] <MainPr
obeAgent.java120> - Main probe started succesfully
jvm 1      | =====
jvm 1      | Finished startup sequence
jvm 1      | Please press <CTRL-c> for an orderly and clean exit ...
jvm 1      | =====

```

## Create Monitors

You create a SAP CCMS monitor and general SiteScope monitors to get the complete picture.

This task includes the following steps:

- ▶ “Create a SAP CCMS Monitor” on page 146
- ▶ “Create General Monitors” on page 146

### **1 Create a SAP CCMS Monitor**

The SAP CCMS monitor retrieves and reports measurements using SAP centralized monitoring system CCMS. CCMS is used to monitor all servers, components, and resources in the SAP R/3<sup>®</sup> System from one single centralized server facilitating problem discovery and problem diagnosis.

For details on creating a SAP CCMS Monitor, see “SAP CCMS Monitor Overview” in *Using System Availability Management*.

SAP CCMS Monitor solution template is the most effective way to deploy a CCMS monitor. For details, see “Deploy a CCMS Monitor Using the SiteScope CCMS Solution Template” on page 136.

### **2 Create General Monitors**

You create general SiteScope monitors to get the complete picture. For example, use:

- ▶ Database Query monitor. For details, see “Database Query Monitor Overview” in *Using System Availability Management*.
- ▶ Ping monitor, and so on. For details, see “Ping Monitor Overview” in *Using System Availability Management*.

## Use a Business Process Monitor Profile to Simulate SAP Users

Use Business Process Monitor profiles to simulate SAP users and obtain performance and availability information on the SAP transactions.

You can view Business Process Steps under the SAP view to enable you to analyze what happens in the SAP system.

This task includes the following steps:

- ▶ “Create a Business Process Monitor Profile” on page 147
- ▶ “Select the Appropriate Protocol” on page 147
- ▶ “Select the Appropriate Run-Time Settings” on page 147
- ▶ “Edit the Script” on page 148
- ▶ “Synchronize the Business Process Monitoring Source Adapter” on page 149
- ▶ “Attach Business Process Monitor Transactions to SAP Application Components” on page 150
- ▶ “Check/View the Business Process Monitor Measurements in the SAP Systems View” on page 153

### 1 Create a Business Process Monitor Profile

You create a business process profile in End User Management. For details, see “Creating Business Process Profiles and Monitors Overview” in *Using End User Management*.

### 2 Select the Appropriate Protocol

In HP Virtual User Generator (VuGen), SAP scripts are recorded using the SAPGUI protocol. You must select the SAPGUI protocol when you create a new script. For details, see *HP Virtual User Generator User's Guide*.

### 3 Select the Appropriate Run-Time Settings

In VuGen, open the Run-Time settings window, and select the **SAPGUI:General** node. Select **Show SAP client during replay** and clear **Take Active screenshots during replay** to give more accurate user experience times. For details, see *HP Virtual User Generator User's Guide*.

## 4 Edit the Script

You can edit the script to make sure the password is recorded properly and to check and correct the script's connection parameters.

To edit the script:

- a** Make sure the password is recorded correctly. Remove the stars and replace with the required password.

```

MI7_VA01 - SAPGUI
vuser_in1
Action
vuser_end
k_stings.h
globals.h

sapgui_select_active_connection("con[0]");
sapgui_select_active_session("ses[0]");
sapgui_select_active_window("wnd[0]");

sapgui_window_maximize(
    BEGIN_OPTIONAL,
    "AdditionalInfo=sapgui104",
    END_OPTIONAL);

sapgui_login("junior01",
    "*****",
    "800",
    "en",
    BEGIN_OPTIONAL,
    "AdditionalInfo=sapgui105",
    END_OPTIONAL);

lr_start_transaction("va01_mi7_enter");

lr_think_time(52);

sapgui_set_ok_code("va01",
    BEGIN_OPTIONAL,
    "AdditionalInfo=sapgui106",
    END_OPTIONAL);

sapgui_send_vkey(ENTER,
    BEGIN_OPTIONAL,
    "AdditionalInfo=sapgui107",
    END_OPTIONAL);

lr_end_transaction("va01_mi7_enter",LR_AUTO);

lr_start_transaction("va01_mi7_initial_screen");
  
```

For Help, press F1. Col:18 Line:28 INS CAP NUM SCRL

- b** Check the script's connection parameters and if necessary, delete the string that appears after the system number in the first parameter.

The result is as follows:

```

noname5 - SAPGUI
Script Title      :
Script Description :

Recorder Version  : 1008
-----
vuser_init()
{
    sapgui_open_connection_ex("/SAP_CODEPAGE=1100 /FULLMENU Pipeline 00",
        "Pipeline - 4.7",
        "con[0]");

    sapgui_select_active_connection("con[0]");

    sapgui_select_active_session("ses[0]");

    sapgui_select_active_window("wnd[0]");

    sapgui_window_maximize(
        BEGIN_OPTIONAL,
        "AdditionalInfo=sapgui104",
        END_OPTIONAL);

    sapgui login("junior01").
}

```

Execution Log

```

Starting iteration 1.
Starting action Action.
Ending action Action.
Ending iteration 1.
Ending Vuser...
Starting action vuser_end.
Ending action vuser_end.
Vuser Terminated.

```

For Help, press F1. Col:76 Line:12 INS CAP NUM SCRL

## 5 Synchronize the Business Process Monitoring Source Adapter

You can synchronize the Business Process Monitoring source adapter immediately or you can wait for the automatic synchronization to take place. For details, see “Source Manager Page” in *Model Management*.

## 6 Attach Business Process Monitor Transactions to SAP Application Components

To display Performance and Availability information, Business Process Steps must be attached to SAP transactions.

You can connect BMP transactions to a SAP transaction in two different ways:

- Follow the naming conventions for the BMP transaction names. For details, see “Follow the Naming Conventions for Naming Business Process Steps” on page 150.
- Do **not** follow the naming conventions for the BMP transaction names and manually link a Business Process Step to a SAP transaction. For details, see “Attach Business Process Steps to a SAP Transaction without Following the Naming Conventions” on page 151.

If you do not follow the naming conventions, be careful when deleting links between SAP transactions and Business Process Steps. For details, see “Delete Links Between SAP Transactions and Business Process Steps” on page 152.

### Follow the Naming Conventions for Naming Business Process Steps

To logically connect Business Process Steps to a SAP transaction, the Business Process Step name should have the following format:

`<tran_name>_<sys_name>_<BPM_tran_name>`

- **tran\_name.** The name of the SAP transaction to which you want to attach the Business Process Step.
- **sys\_name.** The name of the SAP System on which the transaction is run (for example, MI7).
- **BPM\_tran\_name.** The unique name of the Business Process Step.

Any set of alphanumeric and mixed case characters are supported (special characters are not allowed). It is good practice to name the transaction so that the name indicates what occurs in that set of dialog steps.

**Note:** You assign the appropriate name to a Business Process Step when you record it. For details, see *HP Virtual User Generator User's Guide*.

---

For example, the names of the Business Process Steps assigned to the SAP transaction VA01 in the MI7 SAP System should start with: va01\_\_mi7\_

In the SAP Systems View, a **Business Process Steps** node that is displayed under a specific SAP transaction is a container under which all relevant transactions are located.

It is important to split a SAP transaction into a few Business Process Monitor transactions so that you are able to pinpoint the problem. For example, if each step of the SAP transaction is a separate Business Process Monitor transaction, you can find the exact part of the SAP transaction where the problem occurs.

### **Attach Business Process Steps to a SAP Transaction without Following the Naming Conventions**

If you do not want to follow the naming conventions for the Business Process Steps, go to System Availability Management and build a Business Process Monitor profile.

You can then manually connect Business Process Steps with SAP transactions. Select **Admin > Universal CMDB > Modeling > IT Universe Manager**, and select **SAP View** in the **View** list. Right-click the SAP transaction that you want to monitor using the BPM profile and select **Attach Related CI** to open the **Attach Related CIs** wizard. Select one of the monitor views (System Monitors view or End User Monitors view) in the **Views** list. Expand and select the Business Process Step to which you want to connect the SAP transaction, and select the **Monitored By for SAP** relationship type, as well as the **Allow CI Update** option.

For details, see “Attach Related CIs Wizard” in *Model Management*.

## Delete Links Between SAP Transactions and Business Process Steps

SiteScope measurements and Business Process Monitor transactions are attached under the appropriate level of the SAP hierarchy. For details, see “Default CIs in the SAP Systems View” on page 155.

A TQL runs in the background and returns:

- **CCMS measurements that are not linked to SAP entities.** Most of the CCMS measurements’ names indicate to which SAP entities they should be attached in the hierarchy.

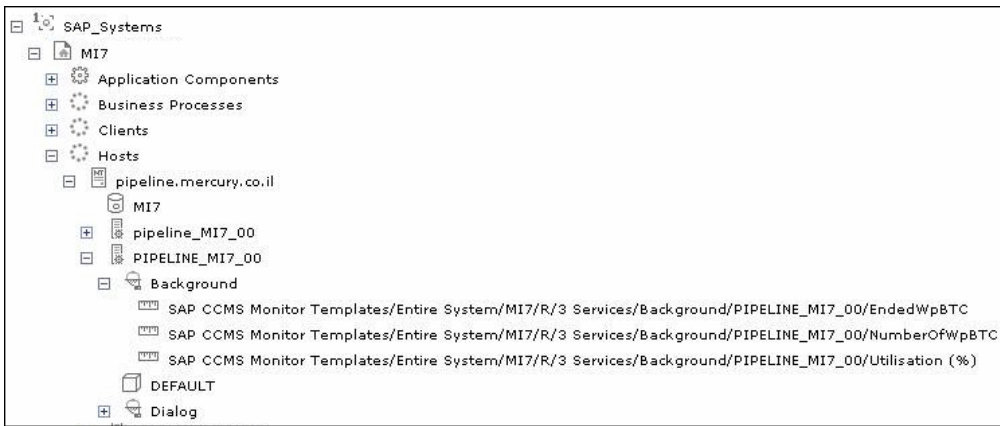

- **Business Process Monitor transactions that are not attached to a SAP and follow the naming convention.** The name of the Business Process Monitor transaction indicates to which SAP entity it should be attached.
- **Business Process steps that are manually attached to a SAP transaction.** A Business Process Step is automatically attached to the Business Process container that was created by the Business Process Step, the Business Process Step is monitored by SAP. For details, see “Attach Business Process Steps to a SAP Transaction without Following the Naming Conventions” on page 151.

If the Business Process Monitor source adapter was assigned the **Transaction/Location** option, a copy of the location information is attached to the Locations container. For details on these types of hierarchy, see “New/Edit Source Adapter Dialog Box” in *Model Management*.



If you delete a link between a SAP transaction and its child Business Process Step transaction, then the following happens:

- ▶ If you followed the naming convention for the Business Process Step transaction, the link between the SAP transaction and its child Business Process Step is automatically recreated at the next synchronization.
- ▶ If you did not follow the naming convention and created a manual link between the SAP transaction and a Business Process Step transaction, then when you delete the link:
  - ▶ If the Business Process Monitoring source adapter was assigned the **Transactions/locations** option, the Location container is not deleted. You can manually delete it. Delete the Location container only if the deleted Business Process Step transaction is the only CI attached to this location. If other Business Process Step transactions are attached to this location, delete only the links between the Business Process Monitor (BPM transaction from location) and the Location container.
  - ▶ If the Business Process Monitoring source adapter was assigned the **Regular** option, the Business Process container is not deleted. You must manually delete the links between the Business Process container and the detached Business Process Step transaction.

For details about the **Transactions/locations** or **Regular** options, see “New/Edit Source Adapter Dialog Box” in *Model Management*.

## **7 Check/View the Business Process Monitor Measurements in the SAP Systems View**

You can view the Business Process Measurement in the SAP Systems view in different locations in the SAP hierarchy. For details, see “Business Process Monitor Measurements in SAP Systems View – Details” on page 118.

## Display SAP Information in Dashboard

You can display SAP information in Dashboard using one of the following views or reports:

- ▶ **View SAP data in Dashboard.** For details, see “SAP Systems View” on page 126.
- ▶ **View the CIs affected by a root cause CI.** Select a CI, which is defined by a correlation rule as a root cause CI, and to display all of the CIs that are affected by it. For details, see “Show Impact Report” on page 162.
- ▶ **View the root cause CIs.** Retrieve root cause information for CIs that are affected by a chain of correlation rules. For details, see “Troubleshooting and Limitations” on page 172.
- ▶ **View Changes Made to SAP System CIs.** Changes made to the properties of all types of CIs are discovered by different types of discoveries. For details, see *Performing a SAP Discovery in Application Administration*. Those changes are displayed in the Change report available as a right-click menu option for each one of the relevant CI types. For details, see “Change Report Page” in *Model Management*.

Some of the changes made to the SAP Transactions CIs are caused by the corresponding Transport CIs. Those specific changes are processed by correlation rules in discovery and are displayed in the SAP Transaction Changes report and the SAP Transport Changes report:

- ▶ **Display a SAP Transaction Changes report.** The report displays and track changes made to a SAP Transaction CI when a transport was discovered. For details, see “SAP Transaction Changes Report” on page 166.
- ▶ **Display a SAP Transport Changes report.** The report includes the transports discovered in the past week, the changes that are included in each transport, and under each change the SAP transaction that is impacted by this change. For details, see “SAP Transport Changes Report” on page 169.

► **Display Configuration File, Software Component File, and Support Package File Information.** You can display additional information for specific CIs:

- **Configuration File information.** For details, see “Configuration File Page” on page 161.
- **Software components file information.** For details, see “Software Components File Information” on page 163.
- **Support packages file information.** For details, see “Support Packages File Information” on page 164.

You can also access this information by selecting **Admin > Universal CMDDB > Modeling > IT Universe Manager > Properties**. For details, see “Properties Dialog Box” in *Model Management*.

## **Default CIs in the SAP Systems View**

The SAP System CIs are listed in the following table:

CI Type (A-Z)	Description
<b>Application Gateway</b>	An Internet Transaction Server (ITS) component. The CI establishes the connection to the R/3 System and performs the processing of tasks that are required to move data between R/3 applications and the Internet.
<b>BPM Monitor</b>	Represents Business Process Monitor entities.
<b>Business Process Step</b>	These CIs (BPM transactions inside a script) are emulated SAP transactions executed on a Business Process Monitor machine. They are used to supply proactive monitoring of end user experience.
<b>Business Processes</b>	A logical container that contains all of the Business Process steps attached to all of the SAP transactions.
<b>CCMS Counters</b>	These CIs (also called Measurements) are information elements, relevant to SAP, retrieved from SAP CCMS (Computer Center Management System).

CI Type (A-Z)	Description
<b>Client</b>	An organizational and legal CI in the SAP system. The main objective of the client is to keep the data isolated. The data in a client can only be visible within that client; it cannot be displayed or changed by another client. Each client on a system can represent a unique working environment.
<b>Configuration File</b>	The system/servers configuration parameters.
<b>Contained Locations</b>	These CIs are created as part of the Business Process Monitor hierarchy when working with the Transactions/locations option.
<b>Database</b>	A database management system holding the data tier, including all of the SAP elements: SAP transactions, programs, work processes, and so on. This is not a SAP-specific CI.
<b>Hosts</b>	<p>A logical unit, grouping together Host CIs.</p> <p>A Host CI represents the physical machine on which a server is installed. This is not a SAP-specific element.</p>
<b>Locations</b>	<p>A logical unit, grouping together Contained Locations CIs.</p> <p>To separate the SAP Business Process steps locations status from the Location CI (from the Business Process Monitor), the Contained Locations CIs are created by the SAP solution and are connected to the SAP Business Process steps (identified by following the naming convention or by manually linking them).</p> <p>The regular Location CI is connected to all Business Process steps both regular and SAP, but the Contained Location CI is connected only to the SAP Business Process steps.</p> <p>The Locations information represents the locations specified in <b>Admin &gt; Universal CMDB</b>, select the CI and click the Properties tab, locate the <b>Location Name</b> property.</p>

CI Type (A-Z)	Description
<b>Monitor</b>	SiteScope entities used to monitor the various CIs that exist in the CMDB. The monitors that are most likely to appear in the SAP view are host monitors: CPU, memory, disk space, and so on. These monitors appear in the SAP view only if they are manually attached to the Host CI.
<b>R/3 Application Server</b>	SAP R/3 Application Server is SAP's integrated software solution for client/server and distributed open systems. R/3 Application servers and databases are displayed under Hosts. You can also have several levels of hosts under the Hosts CI, SiteScope Monitor CIs, and CCMS Monitor CIs.
<b>SAP Application Component</b>	May include other SAP Application Components and some SAP transactions with some common denominator.
<b>SAP Applications</b>	A logical unit, grouping together Application Components.
<b>SAP System</b>	A logical unit, grouping together SAP-related CIs (and possibly other CIs as well) into one homogeneous SAP deployment.
<b>SAP Transaction</b>	Part of a business process defined in the SAP System. It is comprised of request-response couples called dialog steps. The end user uses SAP transactions to carry out actions on the SAP System.
<b>Software Component</b>	Represents a software component installed on the SAP System, for example: SAP_ABA (cross-application component), SAP_HR (human resources), and so on.
<b>Solution Manager Projects</b>	Includes SAP Business Project CIs, SAP Scenario CIs, SAP Business Process CIs, and SAP Business Process Step CIs. Solution Manager Projects hierarchy is specified by the user in SAP Solution Manager.
<b>Support Package</b>	Contains quality improvements for the SAP system, or adjustments due to legal changes.

CI Type (A-Z)	Description
<b>Transports</b>	Represents packaged change requests that include the changes that are to be deployed onto the system.
<b>Web Gateway</b>	An Internet Transaction Server (ITS) component. A web server extension that establishes the connection between ITS and the Web server and forwards user requests to the Application Gateway.
<b>Work Processes</b>	<p>A logical, single-instance representation of all of the work processes of the same type existing on the R/3 server.</p> <p>Several types of work processes are available:</p> <ul style="list-style-type: none"> <li>▶ <b>Dialog Work Process.</b> Executes dialog programs (ABAP).</li> <li>▶ <b>Update Work Process.</b> Responsible for asynchronous database changes (controlled by a COMMIT WORK statement in a dialog work process).</li> <li>▶ <b>Update2 Work Process.</b> Used for statistical, non-critical updates (for example, result calculations).</li> <li>▶ <b>Background Work Process.</b> Executes time-dependent or event-controlled background jobs.</li> <li>▶ <b>Enqueue Work Process.</b> Executes locking operations (if SAP transactions have to synchronize themselves).</li> <li>▶ <b>Spool Work Process.</b> Performs print formatting (to printer, file, or database).</li> </ul>

## SAP-Related KPIs

Different Key Performance Indicators (KPIs) are displayed depending on the selected CI. For details about the displayed KPIs, see “Default CIs in the SAP Systems View” on page 155.

The following table lists the SAP-related KPIs displayed in the Console tab:

GUI Element (A-Z)	Description
<b>SAP</b>	The SAP KPI indicates problems related to the SAP infrastructure that are reported by CCMS.
<b>Transactions</b>	At the group level, displays the worst status of all of the child CIs. At the monitor level, displays the worst status of the <b>Performance</b> and <b>Availability</b> KPIs for the CI.
<b>Locations</b>	At the group level, displays the worst status of all of the child CIs. At the monitor level, displays the worst status of the <b>Performance</b> and <b>Availability</b> KPIs for the CI.

The other KPIs displayed in the views are not SAP-related. For more details about those KPIs, see “List of Dashboard KPIs and Their Details” in *CI Attribute Customization*.

## SAP-Related Menu Options

A list of all of the context menu options available in the SAP Systems view is available in “Customize Dashboard Display and Refresh Rate” in *Using Dashboard*.

Different menu options are available depending on the type of CIs:

Context Menu Option	Type of CI
Show Impact	All SAP-specific CI types
Problem Isolation	All SAP-specific CI types
SAP Transport Changes Report	SAP System and SAP Transports CIs
SAP Transaction Changes Report	SAP System and SAP Transaction CIs

## HP Business Availability Center for SAP Applications User Interface

### **This section describes:**

- Configuration File Page on page 161
- Show Impact Report on page 162
- Software Components File Information on page 163
- Support Packages File Information on page 164
- Problem Isolation Report on page 165
- SAP Transaction Changes Report on page 166
- SAP Transport Changes Report on page 169



## Configuration File Page

```
MI6_DVEBMGS00_CALDERONE (read-only)
#parameter created          by: DNISSANI   17.12.2002 20:36:03
login/system_client = 800
SAPSYSTEMNAME = MI6
INSTANCE_NAME = DVEBMGS00
SAPSYSTEM = 00
SAPGLOBALHOST = calderone
rdisp/wp_no_dia = 8
rdisp/wp_no_vb = 5
rdisp/wp_no_vb2 = 2
rdisp/wp_no_enq = 1
rdisp/wp_no_btc = 4
rdisp/wp_no_spo = 1
zcsa/system_language = E
PHYS_MEMSIZE = 768

sapgui/user_scripting = TRUE
```

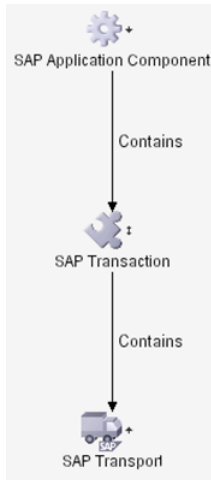

<b>Description</b>	<p>Displays the contents of the configuration file. Details about the SAP configuration file are provided in the SAP product documentation.</p> <p><b>To Access:</b> Right-click a Configuration File CI in the SAP Systems View, select <b>Properties</b>, and click <b>Show document content</b>.</p>
--------------------	---

## Show Impact Report



<p><b>Description</b></p>	<p>Enables you to display all of the CIs that are affected by the selected CI, which is defined as a root cause by a correlation rule. The report also displays the CI's statuses.</p> <p><b>To Access:</b> In Dashboard, access the <b>SAP Systems</b> view, and in View Explorer, click the gray arrow ▼ to the right of the element, or right-click a SAP System CI or a SAP Transaction CI and select <b>Application Mapping &gt; Show Impact</b>.</p>
<p><b>Important Information</b></p>	<p>For details about correlation rules, see “Correlation Manager” in <i>Model Management</i>.</p>
<p><b>Included in Tasks</b></p>	<p>“Display SAP Information in Dashboard” on page 135</p>

The following elements are included (unlabeled GUI elements are shown in angle brackets>):

GUI Element (A-Z)	Description
	Indicates the root cause CI.
	Indicates a CI that is part of the correlation rule, but is neither the root cause CI nor an affected CI.
	Indicates an affected CI.

## Software Components File Information

```
software_components (read-only)
Name = IDES
Package Level =
Type = Main component
Description =
Release = 4.6C

Name = PI
Package Level = A
Type = Main component
Description = PI 2003_1_46C : Add-On Delta Upgrade
Release = 2003_1_46C

Name = SAP_ABA
Package Level =
Type = Main component
Description = Componente multiplicaciones
Release = 46C
```

<b>Description</b>	Displays the contents of the software components file. <b>To Access:</b> Right-click a Software Component CI in the SAP Systems View, select <b>Properties</b> , and click <b>Show document content</b> .
--------------------	--

The following elements are included (unlabeled GUI elements are shown in angle brackets>):

GUI Element (A-Z)	Description
<b>Description</b>	The description of the package.
<b>Name</b>	The name of the software component.
<b>Package Level</b>	The level of the package.
<b>Release</b>	The release number.

## Support Packages File Information

```

support_packages (read-only)
Name = DM1K900013
Type = Patch has been applied
Description = Sprachenexport Z1 16.09.2002 (BUCHERT)

Name = SAPK-03A7GINSDF
Type = Patch has been applied
Description = Solution Tools Plugin (ST-PI 003A_620)

Name = SAPK-10001INLSOFE
Type = Patch has been applied
Description = LSOFE 100 (Learning Solution - Front End)
    
```

<b>Description</b>	Displays the contents of the support packages file. <b>To Access:</b> Right-click a Support Package CI in the SAP Systems View, select <b>Properties</b> , and click <b>Show document content</b> .
--------------------	--

The following elements are included (unlabeled GUI elements are shown in angle brackets>):

GUI Element (A-Z)	Description
<b>Description</b>	The description of the package.
<b>Name</b>	The name of the support package.
<b>Type</b>	The type of support package.

## Problem Isolation Report

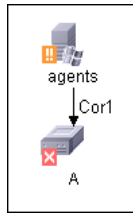

<b>Description</b>	<p>Enables you to retrieve root cause information for CIs that are affected by a chain of correlation rules. The report displays a logical map that describes a chain of trigger/affected CITs that affect the CI.</p> <p><b>To Access:</b> In Dashboard, access the <b>SAP Systems</b> view, and in View Explorer, click the gray arrow ▼ to the right of the element, or right-click a SAP System CI or a SAP Transaction CI and select <b>Application Mapping &gt; Problem Isolation</b>. For details, see “Customize Dashboard Display and Refresh Rate” in <i>Using Dashboard</i>.</p>
<b>Included in Tasks</b>	“Display SAP Information in Dashboard” on page 135
<b>Important Information</b>	For details about correlation rules, see “Correlation Manager” in <i>Model Management</i> .

GUI Element (A-Z)	Description
<Relationship>	The relationships represent the Correlation rule you defined in Correlation Manager. For details, see “Correlation Definition Dialog Box” in <i>Model Management</i> .
<The statuses and the colors that represent each one>	The statuses that appear and the colors that represent each status are the ones that were defined in the severity list for that state in System Type Manager. For details, see “Create/Update List/Enumeration Definition Dialog Box” in <i>CI Attribute Customization</i> .

## SAP Transaction Changes Report

System Report for: SAP_Transaction_Change						
<b>MI6(SAP System)</b>						
Name	MI6					
<b>ZMTRANS1(SAP Transaction)</b>						
Name	ZMTRANS1	Devclass	ZINSPECTION_FOR_MAM	Program	ZMPROG1	
Program Version		Screen	0100			
<b>CIT Name = SAP Transport</b>						
Title	Name	Description	Creation Date	User	Target System	
MI6K900518 (SAP Transport)	MI6K900518		2006.02.21 14:15:05:00	Sigalit Sade	TRN	
MI6K900370 (SAP Transport)	MI6K900370		2006.01.17 11:20:49:00	Sigalit Sade		
MI6K900516 (SAP Transport)	MI6K900516		2006.02.20 15:54:11:00	Ofer Mekmal	TRN	
MI6K900508 (SAP Transport)	MI6K900508		2006.02.20 14:53:25:00	Sigalit Sade	TRN	
MI6K900416 (SAP Transport)	MI6K900416		2006.01.26 10:06:18:00	Sigalit Sade		
MI6K900432 (SAP Transport)	MI6K900432		2006.01.26 11:22:40:00	Sigalit Sade		
MI6K900422 (SAP Transport)	MI6K900422		2006.01.26 11:09:22:00	Sigalit Sade		
MI6K900442 (SAP Transport)	MI6K900442		2006.01.26 12:20:52:00	Sigalit Sade		
<b>ZMTRANS2(SAP Transaction)</b>						
Name	ZMTRANS2					
Program Version		Screen	0100			
<b>CIT Name = SAP Transport</b>						
Title	Name	Description	Creation Date	User	Target System	
MI6K900418 (SAP Transport)	MI6K900418		2006.01.26 10:09:11:00	Sigalit Sade		
MI6K900434 (SAP Transport)	MI6K900434		2006.01.26 11:29:58:00	Sigalit Sade		
MI6K900516 (SAP Transport)	MI6K900516		2006.02.20 15:54:11:00	Ofer Mekmal	TRN	
MI6K900373 (SAP Transport)	MI6K900373		2006.01.17 11:38:02:00	Sigalit Sade		
MI6K900424 (SAP Transport)	MI6K900424		2006.01.26 11:11:19:00	Sigalit Sade		
MI6K900520 (SAP Transport)	MI6K900520		2006.02.21 14:37:58:00	Sigalit Sade	TRN	
<b>ZMTRANS3(SAP Transaction)</b>						
Name	ZMTRANS3					
Program Version		Screen	0100			

<p><b>Description</b></p>	<p>Enables you to display and track changes made to a SAP Transaction CI when a transport was discovered. The SAP Transaction Change report displays information about the SAP systems with changed transactions, and under each transaction the SAP transports that have changed during the past week (you can modify the default).</p> <p><b>To Access:</b> In Dashboard, access the <b>SAP Systems</b> view, and in View Explorer, click the gray arrow ▼ to the right of the element, or right-click a SAP System CI or a SAP Transaction CI and select <b>Application Mapping &gt; SAP Transaction Changes report</b>.</p> <p>For details, see “Customize Dashboard Display and Refresh Rate” in <i>Using Dashboard</i>.</p>
<p><b>Included in Tasks</b></p>	<p>“Display SAP Information in Dashboard” on page 135</p>

### SAP System Level Area

The following elements are included (unlabeled GUI elements are shown in angle brackets>):

GUI Element (A-Z)	Description
<p><b>Name</b></p>	<p>The name of the SAP system with a new transaction.</p>

### SAP Transaction Level Area

The following elements are included (unlabeled GUI elements are shown in angle brackets>):

GUI Element (A-Z)	Description
<b>Devclass</b>	The development class that includes the transaction.
<b>Name</b>	The name of the SAP transaction that has changed.
<b>Program</b>	The name of the program that runs the transaction.
<b>Program Version</b>	The version of the program that runs the transaction.
<b>Screen</b>	The first screen that opens when you load the transaction.

### SAP Transport Level Area

The following elements are included (unlabeled GUI elements are shown in angle brackets>):

GUI Element (A-Z)	Description
<b>Creation Date</b>	The date when the transport was created.
<b>Description</b>	The description of the transport.
<b>Name</b>	The name of the transport that has changed.
<b>Target System</b>	The target system for non-local transport.
<b>User</b>	The name of the user who created the transport.



## SAP Transport Changes Report

System Report for: SAP\_Transports

**MI6(SAP System)**

Name MI6

**MI6K900424(SAP Transport)**

Name MI6K900424 Description Table called by Include & Program-ZMTRANS2\_3 User Sigalit Sade

Creation Date 2006.01.26 11:11:19:00 Target System

**Table:ZMTAB\_BY\_INCL2\_3(SAP Transport Change)**

Object Name ZMTAB\_BY\_INCL2\_3 Object Type Table

**CIT Name = SAP Transaction**

Title	Name	Devclass	Program	Program Version	Screen
ZMTRANS3 (SAP Transaction)	ZMTRANS3	ZINSPECTION_FOR_MAM	ZMPROG2_3		0100
ZMTRANS2 (SAP Transaction)	ZMTRANS2	ZINSPECTION_FOR_MAM	ZMPROG2_3		0100

**Table:ZMTAB\_BY\_PROG2\_3(SAP Transport Change)**

Object Name ZMTAB\_BY\_PROG2\_3 Object Type Table

**CIT Name = SAP Transaction**

Title	Name	Devclass	Program	Program Version	Screen
ZMTRANS2 (SAP Transaction)	ZMTRANS2	ZINSPECTION_FOR_MAM	ZMPROG2_3		0100
ZMTRANS3 (SAP Transaction)	ZMTRANS3	ZINSPECTION_FOR_MAM	ZMPROG2_3		0100

**MI6K900516(SAP Transport)**

Name MI6K900516 Description transporting inspection of MAM User Ofer Mekmal

Creation Date 2006.02.20 15:54:11:00 Target System TRN

**Transaction:ZMTRANS2(SAP Transport Change)**

Object Name ZMTRANS2 Object Type Transaction

**CIT Name = SAP Transaction**

Title	Name	Devclass	Program	Program Version	Screen
ZMTRANS2 (SAP Transaction)	ZMTRANS2	ZINSPECTION_FOR_MAM	ZMPROG2_3		0100

### Description

The table displays information about the SAP systems with the transports discovered during the past week (this default is configurable), for each transport the changes that are included in the transport, and for each change, the SAP transaction that is impacted by this change.

**To Access:** In Dashboard, access the **SAP Systems** view, and in View Explorer, click the gray arrow ▼ to the right of the element, or right-click a SAP System CI or a SAP Transaction CI and select **Application Mapping > SAP Transaction Changes report**.

<p><b>Important Information</b></p>	<p><b>Customization:</b></p> <ul style="list-style-type: none"> <li>➤ By default, transports that are older than a month are automatically deleted from the CMDB. To modify the default, select <b>Admin &gt; Universal CMDB &gt; Modeling &gt; Enrichment Manager</b>, expand <b>SAP</b>, select <b>TQL</b>, right-click <b>SAP_Old_Transports</b> in the map, and select <b>Node conditions</b>. Access the Attribute condition dialog box, assign the required condition for the <b>Actual Delete Time - (date)</b> attribute.</li> <li>➤ You can configure the time period during which the transport discovery takes place. Select <b>Admin &gt; Universal CMDB &gt; Modeling &gt; Report Manager</b>, expand <b>SAP</b>, right-click <b>SAP_Transports</b> in the map, and select <b>Node conditions</b>. Access the Attribute condition dialog box, assign the required condition for the <b>Last Access Time - (date)</b> attribute.</li> </ul>
<p><b>Included in Tasks</b></p>	<p>“Display SAP Information in Dashboard” on page 135</p>

### SAP System Level Area

The following elements are included (unlabeled GUI elements are shown in angle brackets>):

GUI Element (A-Z)	Description
Name	The name of the SAP system.

### SAP Transport Level Area

The following elements are included (unlabeled GUI elements are shown in angle brackets>):

GUI Element (A-Z)	Description
Creation Date	The date when the transport was created.
Description	The description of the transport.
Name	The name of the transport that has changed.
Target System	The target system for non-local transport.
User	The name of the user who created the transport.

### SAP Transport Change Level Area

The following elements are included (unlabeled GUI elements are shown in angle brackets>):

GUI Element (A-Z)	Description
Devclass	The development class that includes the transaction.
Name	The real name of the transaction.
Object Name	The change that was made.
Object Type	The object that changed.
Program	The name of the program that runs the transaction.
Program Version	The version of the program that runs the transaction.
Screen	The first screen that opens when you load the transaction.
Title	The name of the transaction followed by <b>(SAP Transaction)</b> .

## Troubleshooting and Limitations

This section provides information that can help troubleshoot problems that may occur when working with HP Business Availability Center for SAP Applications.

This section includes the following topics:

- “The SAP KPI Remains Uninitialized” on page 172
- “CCMS Does Not Manage to Monitor a SAP System” on page 173
- “The Performance and Availability KPIs Remain Uninitialized” on page 173
- “SAP Business Process Monitor Scripts Do Not Execute” on page 174
- “Unable to Log Into HP Business Availability Center” on page 174
- “Limitations” on page 175

### The SAP KPI Remains Uninitialized



If the SAP KPI remains uninitialized, check the following solutions in the order listed below:

- 1** Make sure the SAP CCMS monitor is set to send samples to HP Business Availability Center in the monitor’s **Logging to HP Business Availability Center** property in System Availability Management.
- 2** Check the following file to ensure that the samples arrive to the Business Logic Engine:  
**<HP Business Availability Center root directory>\log\EJBContainer\TrinitySamples.log**
- 3** Check that the samples arrive to the bus in the following file:  
**<HP Business Availability Center root directory>\log\core\dispatcher\_log.txt**
- 4** Check that the samples are sent in the following file:  
**<SiteScope root directory>\logs\topaz\_all.log.1**
- 5** If you see values in the measurements' KPIs that are not colored, check the threshold definition in System Availability Management.

- 6 Restart SiteScope, detach it, and reattach it.
- 7 Check time synchronization between HP Business Availability Center and its management database.

### **CCMS Does Not Manage to Monitor a SAP System**

If CCMS does not manage to monitor a SAP System, check the following solutions in the order listed below:

- 1 If you are able to connect to the SAP System using SAP Logon, run the **rz20** transaction.
- 2 Open **SAP CCMS Monitor Templates > Entire System**, and check if a tree is displayed.
  - ▶ If there is no tree, there might be a problem with the job that is collecting CCMS information. Contact your SAP administrator.
  - ▶ If there is a tree, check that the names of the application server and of the system match, in content and case, the ones used in SiteScope.

### **The Performance and Availability KPIs Remain Uninitialized**

If the Performance and Availability KPIs remain uninitialized, check the following solutions in the order listed below:

- 1 Check that the samples arrive, in the file:  
**<HP Business Availability Center root directory>\log\EJBContainer\TrinitySamples.log**
- 2 Try and run Business Process Monitor as a specific user.
- 3 Check time synchronization between HP Business Availability Center and its Management database.
- 4 Check the minute's synchronization between Business Process Monitor and HP Business Availability Center.

## SAP Business Process Monitor Scripts Do Not Execute

If the SAP Business Process Monitor scripts do not execute, check the following solutions in the order listed below:

- 1 Verify that SAP Logon is installed on the Business Process Monitor server.
- 2 Check that the SAP Business Process Monitor scripts run in HP Virtual User Generator (VuGen) and check the script's connection parameters. For details, see "Edit the Script" on page 148.
- 3 Register DLLs under `<Business_Process_Monitor_install_directory>\bin`, as follows:
  - `regsvr32 SapGuiActiveScreen.dll`
  - `regsvr32 SapGuiReplayEvents.dll`
  - `regsvr32 ActiveScreen.dll`

## Unable to Log Into HP Business Availability Center

If you are unable to log into HP Business Availability Center, check the following solutions in the order listed below:

- 1 Check that the last line in the following file:  
`<SiteScope root directory>\log\jboss_boot.log`  
displays the following information: JBoss .... started in ...
- 2 If you are able to connect using port **8080** explicitly, give the **Read and Execute** permission to **Everyone** for the following DLLs in `<Windows installation directory>\System32`:
  - `msvcr71.dll`
  - `msvc71.dll`
  - `mfc71.dll`
  - `atl71.dll`

- 3 If SiteScope is installed on the same machine as HP Business Availability Center, check that HP Business Availability Center is already running before you start SiteScope.

---

**Note:** It is not recommended to install HP Business Availability Center and SiteScope on the same machine.

---

### **Limitations**

- ▶ An existing Business Process Monitor machine can be leveraged for running SAP scripts as well.
- ▶ The SAP CCMS Monitor is an optional SiteScope feature whose license is provided with the SAP solution.
- ▶ You must have a SAP license to view the SAP\_Systems view in HP Business Availability Center.
- ▶ Transports that are older than a month are automatically deleted from the CMDB. The default is configurable.





# Part III

---

## HP Business Availability Center for Siebel Applications



# 3

---

## HP Business Availability Center for Siebel Applications

This chapter describes the HP Business Availability Center for Siebel Applications solution.

### **This chapter includes:**

#### Concepts

- ▶ HP Business Availability Center for Siebel Applications – Overview on page 180
- ▶ Diagnostics Tools on page 182
- ▶ License on page 186
- ▶ Architecture on page 187
- ▶ Working with Firewalls on page 188
- ▶ Siebel Monitors on page 189
- ▶ The Siebel Service on page 190
- ▶ Siebel Views on page 191

#### Tasks

- ▶ Deploy HP Business Availability Center for Siebel Applications – Workflow on page 194
- ▶ Configure HP Business Availability Center for Siebel Applications on page 211
- ▶ Verify Diagnostics-Related Settings on page 212
- ▶ Delete Links Between Siebel Applications and Business Process Steps on page 216

- ▶ Deploy the SiteScope Siebel Monitors on page 216
- ▶ Display Siebel Information in Dashboard on page 225
- ▶ Create Customized Deployment Validator Tests on page 228
- ▶ Customize HP Business Availability Center for Siebel Applications on page 230

#### Reference

- ▶ Context Menu Options on page 232
- ▶ Default CITs in the Siebel View on page 234
- ▶ HP Business Availability Center for Siebel Applications User Interface on page 237
- ▶ Troubleshooting and Limitations on page 274

## **HP Business Availability Center for Siebel Applications – Overview**

HP Business Availability Center for Siebel Applications, integrating SiteScope, Business Process Monitor, and HP Universal CMDB, enables you to gain visibility and control over your mission-critical Siebel applications.

The Siebel solution provides:

- ▶ A single operation console consolidating all Siebel monitoring information.
- ▶ Automatic discovery and modeling of Siebel-related elements, as well as their relationships to other systems in the organization's Information Technology (IT) department.
- ▶ Change discovery and notification for quicker problem resolution.
- ▶ Proactive monitoring of end-user experience in Siebel enterprises.
- ▶ The ability to distinguish between Siebel-specific problems and general ones.
- ▶ Management of Siebel-related service level commitments.

**Note:** You must have an HP Business Availability Center for Siebel Applications license to view the Siebel Enterprises view in HP Business Availability Center.

---

HP Business Availability Center for Siebel Applications consolidates Siebel components and business processes in the Siebel Enterprises view to gain real-time visibility over the entire Siebel infrastructure from a business perspective.

HP Business Availability Center for Siebel Applications also monitors, reports, and issues alerts on the performance and functionality of the Siebel eBusiness applications and servers that comprise your Siebel Enterprise business process infrastructure.

Using HP Business Availability Center for Siebel Applications, your IT operation can analyze how each link in the Siebel Enterprise chain is affecting the user experience of customers, partners, suppliers, and employees. This enables your IT team to more accurately assess the resulting impact on business performance. It also enables the IT team, Siebel application support team, and Siebel Expert Services to take any steps that might be necessary to maximize availability, performance, and service levels to provide quality of service for all Siebel applications and end users.

The Siebel Enterprises view is available in the Dashboard. For details, see “View Configuration File CI – Details” on page 227.

Right-click the CIs in the Siebel Enterprises view to access additional information and diagnostics tools. For details on the context menu, see “Context Menu Options” on page 232. For details on the diagnostics tools, see below.

In addition, you can create SLAs centered around your HP Business Availability Center for Siebel Applications Siebel Application CIs to gain visibility into performance or availability issues that affect these SLAs. For details about SLAs, see “Service Level Management - Overview” in *Using Service Level Management*.

## **Diagnostics Tools**

You access the HP Business Availability Center for Siebel Applications information from the Applications menu. The following diagnostics tools are available:

This section includes the following topics:

- ▶ “SARM - User Trace Breakdown” on page 182
- ▶ “Database Breakdown Diagnostic” on page 184
- ▶ “Tasks Diagnostic Tool” on page 185
- ▶ “Siebel Processes Tool” on page 185

### **SARM - User Trace Breakdown**

The Siebel SARM - User Trace Breakdown tool enables you to view Siebel real user monitoring information. The diagnostic tool processes the data in the User Session Trace output files produced by Siebel Application Response Measurement (SARM) process.

This data can be retrieved for a specific user in a specific time frame. It can also be retrieved for a specific transaction of a prerecorded script. For details, see “SARM - User Trace Breakdown (Run the Diagnostics Tool) Page” on page 241 and “SARM - User Trace Breakdown Dialog Box” on page 244 or “Siebel Views” on page 191.

The tool records logs for each Siebel transaction activity in the Web server or in the application server. It also records data about how long each transaction remains in each tier of the Siebel enterprise: Network, Web Server, Application Server, and Database. Siebel SARM tool logs Siebel real user monitoring data into binary SARM files (with .sarm extension). The transaction activity itself is written into the .sarm files.

HP Business Availability Center interacts with SARM Analyzer (a Siebel tool) using remote API calls to SiteScope. These calls activate a batch file, which copies files from Siebel, and then uses the SARM Analyzer to generate user-readable files from the Siebel files. The user-readable files are then copied using SiteScope remote API to HP Business Availability Center.

The SARM - User Trace Breakdown diagnostic tool is built over the Siebel's SARM tool. It produces required CSV and XML files as part of the analysis process, in which the Siebel SARM Analyzer package is utilized. The tool also analyzes and displays a graphical view of the results. It retrieves the SARM data for a specific user, in a specific time frame. It enables retrieving the SARM data for a specific Business Process Monitor transaction that belongs to a prerecorded script with Siebel breakdown enabled.

In the SARM - User Trace Breakdown tab, you can compare this breakdown per user sessions, user transactions, or application servers to enable you to identify the prime suspect for performance problems. You can also drill down within these logs to determine which layer is responsible for the slow response.

The SARM - User Trace Breakdown diagnostic tool is activated on demand.

---

**Note:** The Virtual User Generator script must be recorded using the Siebel Web protocol. Select the **Enable Siebel Breakdown** check box while configuring the Business Process Monitor in System Availability Management. For details, see “Edit Transaction Monitor Page” in *Using End User Management*.

---

Details about how to use the SARM - User Trace Breakdown diagnostics tool are provided in the “SARM - User Trace Breakdown (Run the Diagnostics Tool) Page” on page 241.

## Database Breakdown Diagnostic

The Siebel Database Breakdown diagnostics tool enables you to determine the cause of slow database response time by analyzing the database activity carried out as a result of running a Business Process Step and to extract comprehensive information regarding database time spent by various SQLs. The database activity is logged into database logs created on the Siebel application server.

You analyze Siebel database SQL activity by examining information in the Siebel application server logs. These logs contain a record of SQLs carried out as a result of Siebel components activity.

Logs are constantly created and updated on the Application Server. However, most of the time they are only logging errors, and do not include the extensive information that Database Breakdown can display. To log the extensive database time distribution information, the log level needs to be brought up.

When the user runs Database Breakdown, after defining the analysis' scope (Siebel Enterprise, Application, Business Process Step, and so on, Business Availability Center for Siebel Applications automatically increases (through SiteScope) the database log level for the selected component (if a specific component was selected).

Then, Business Availability Center for Siebel Applications instructs the Business Process Monitor to run the transaction you selected. During the transaction run, as a result of the higher log level, database-related information is written into the application server log.

When the transaction has finished running, the database log level for the selected component is returned to normal by HP Business Availability Center for Siebel.

For details, see “Siebel Database Breakdown Configuration Report” on page 259 and “Siebel Database Breakdown Analysis Report” on page 262.



## Tasks Diagnostic Tool

The Siebel tasks diagnostic tool enables you to view details of the Siebel Application Server tasks, for each monitored Siebel Enterprise. For details, see “Siebel Views” on page 191.

Using the Siebel Tasks Diagnostics tool, you can:

- ▶ Retrieve details of the Siebel Application Server tasks that are running, or were run, on each Siebel Enterprise
- ▶ Choose to view details of all tasks, regardless of status, or details of only these tasks with a specific status
- ▶ Choose to view task details for all components in all component groups on all Siebel Application Servers, or for specific components in specific component groups on specific Siebel Application Servers

For details, see “Tasks Diagnostics Tool Report” on page 271 and “Tasks Diagnostics Tool - Advanced Filter Dialog Box” on page 273.

## Siebel Processes Tool

The Siebel Processes Diagnostic tool enables you to view details of the operating system processes running on the various Siebel Application Servers, for each monitored Siebel Enterprise. For details, see “Siebel Views” on page 191.

To ensure that Diagnostics tools work properly, check the Diagnostics-related settings. For details, see “Verify Diagnostics-Related Settings” on page 212.

Using SiteScope, you can retrieve details of the Siebel Application Server processes that are running, or were run, on each Siebel Enterprise. You can view the details of all processes, regardless of status, or you can view only the processes with a specific status. Similarly, you can choose to view process details for all components in all component groups on all Siebel Application Servers, or for specific components in specific component groups on specific Siebel Application Servers.

When an application has performance/availability issues, you may use the Siebel Processes tool to verify that all Siebel processes are up and running and that none of the processes is using 100% CPU.

For details, see “Processes Report” on page 238 and “Processes Tool - Advanced Filter Dialog Box” on page 240.

## License

The HP Business Availability Center for Siebel Applications license unlocks the following functionality in HP Business Availability Center, helping to shorten time-to-value and MTTR:

- ▶ The Siebel Enterprises pattern view, displaying a hierarchical view of Siebel applications and infrastructure.
- ▶ Automatic linkage of Business Process Monitor transactions to the Siebel transactions they are monitoring.
- ▶ Automatic linkage of SiteScope measurements to their respective Siebel infrastructure.
- ▶ Siebel-specific KPIs that allow differentiation between Siebel-related issues and non-Siebel ones.
- ▶ Siebel diagnostics – SARM, Database Breakdown, Tasks, Processes – for in-depth, in-context data on the Siebel environment.

## Architecture

The architecture of HP Business Availability Center for Siebel Applications is illustrated in the following diagram:

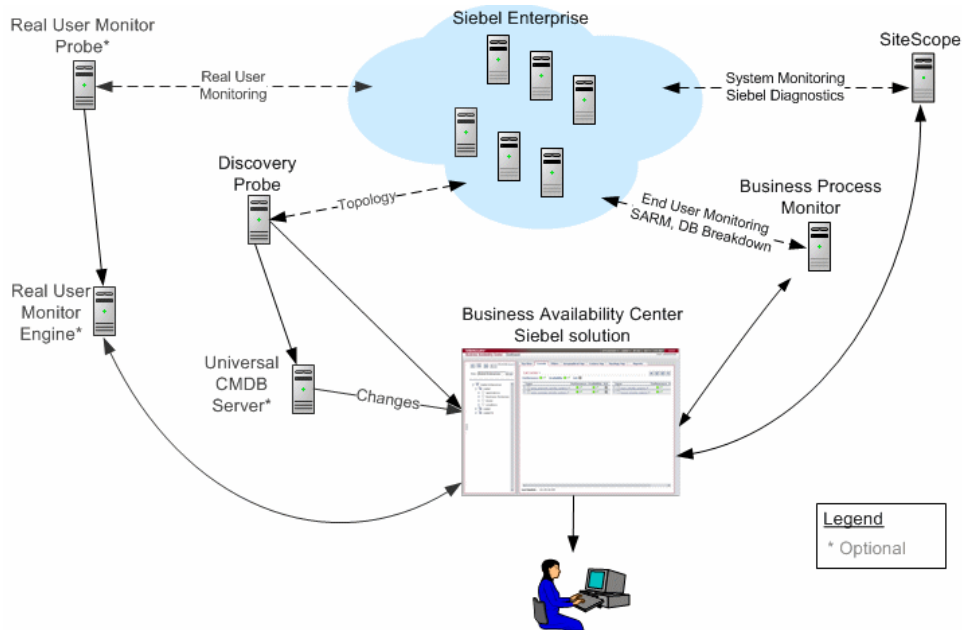

Most of the Siebel CIs are created by automatic discovery. The configuration for these CIs is saved into the CMDB. Some of the relationships to Business Process Monitor and SiteScope CIs are created by automatic mechanisms specific to the HP Business Availability Center for Siebel Applications.

The architecture of the Business Availability Center for Siebel Applications solution includes the following components:

- ▶ The DDM Probe discovers Siebel-related CIs and other CIs (such as hosts) that are related to them.
- ▶ The Real User Monitor Probe monitors real user traffic and sends it to the Real User Monitor engine, that processes and stores it.

- ▶ SiteScope communicates with the Siebel Enterprise system and retrieves system monitoring information using the `svrmgr` CLI tool. It is also used as a middleware for all of the Siebel diagnostics tools.
- ▶ Business Process Monitor collects data on the performance and availability of the Siebel Enterprise by running transactions that correspond to Business Process Steps. It is also used for Database Breakdown, and can be leveraged in SARM; for example, user sessions can be correlated to the corresponding Business Process Monitor transactions.
- ▶ Dashboard tabs and reports are used as the central console for viewing all of the data and performing analysis of the data. For details, see “Using Dashboard” in *Using Dashboard*.

## Working with Firewalls

To work with firewalls, you must install a firewall with a Virtual Private Network (VPN) between:

- ▶ HP Business Availability Center and the Business Process Monitor to view Siebel Application Response Measurement (SARM) - user trace breakdown and/or database breakdown information.
- ▶ HP Business Availability Center and SiteScope to view all diagnostics information.

The following diagram illustrates a possible deployment involving firewalls:

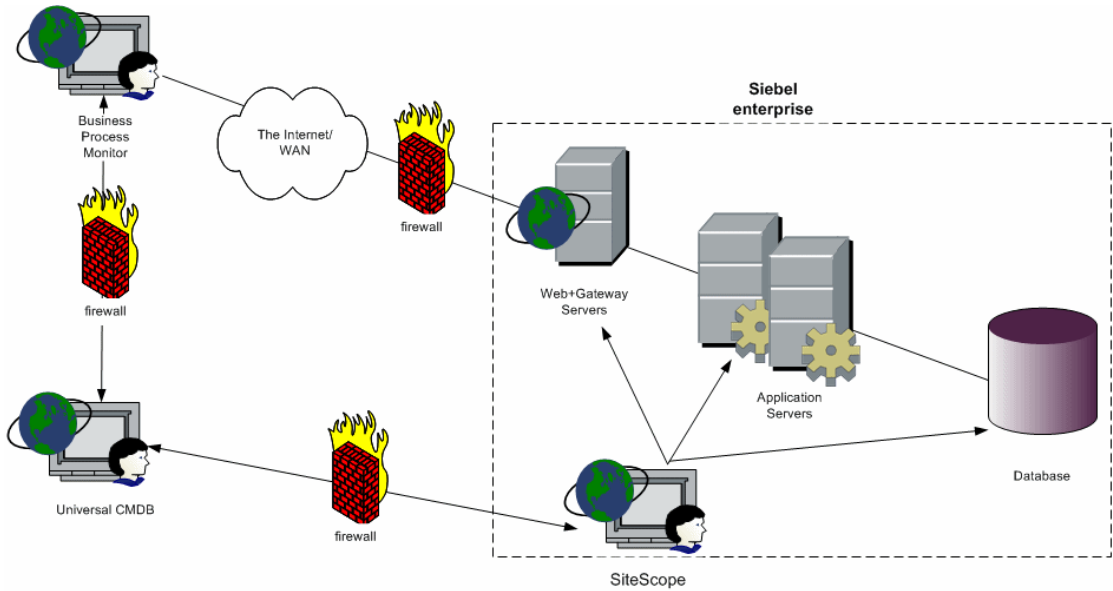

## Siebel Monitors

The SiteScope monitors used to monitor Siebel are:

- ▶ **Siebel Application Server.** Uses Siebel Server Manager client to monitor all aspects of Siebel application servers. For details about the monitor, see “Siebel Application Server Monitor Overview” in *Using System Availability Management*.
- ▶ **Siebel Web Server.** Watches Siebel server login session statistics and gauges the performance of Siebel Server Object Managers and database. For details about the monitor, see “Siebel Web Server Monitor Overview” in *Using System Availability Management*.

- ▶ **Siebel Log Monitor.** Monitors the Siebel log files by searching for entries containing a specific event type or subtype. For details about the monitor, see “Siebel Log File Monitor Overview” in *Using System Availability Management*.

These monitors must be deployed. For details, see “Deploy the SiteScope Siebel Monitors” on page 216.

## The Siebel Service

The Siebel Service is a configuration service that provides the following advantages:

- ▶ Automatic linkage of SiteScope measurements to the relevant CIs based on measurement name.
- ▶ Automatic linkage of Business Process Steps with standardized names to the application they are monitoring. For details, see “Specify a Transaction/Location or Regular Hierarchy in the Business Process Monitor Source Adapter” on page 208.
- ▶ Creation of a Business Process and Locations container and connection of the Business Process Steps monitoring Siebel, and their respective locations, to the containers. For details, see “Specify a Transaction/Location or Regular Hierarchy in the Business Process Monitor Source Adapter” on page 208.

The Siebel Service starts working after BPM source adapters and SiteScope source adapters (if you are working with SiteScope 9.0) have been synchronized.

For details about how to view a service status with the JMX Web console, see “High Availability for the Data Processing Server” in the *HP Business Availability Center Deployment Guide* PDF.

The Siebel Service must be activated. For details, see “Check If the Siebel Service Is Activated” on page 220.

## Siebel Views

The Siebel Enterprises view is enabled by default; the other Siebel views must be enabled before they are displayed.

In Dashboard, access the Siebel Enterprises view to view information about the Siebel IT entities, the Siebel enterprise metrics monitored by SiteScope monitors, and information about the Siebel business processes/transactions simulated by Business Process Monitor scripts.

The Siebel Enterprises view appears as follows:

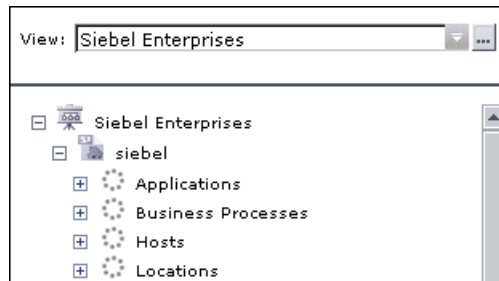

The following graph describes the various layers and drill-downs available in the topology of the Siebel Enterprises view.

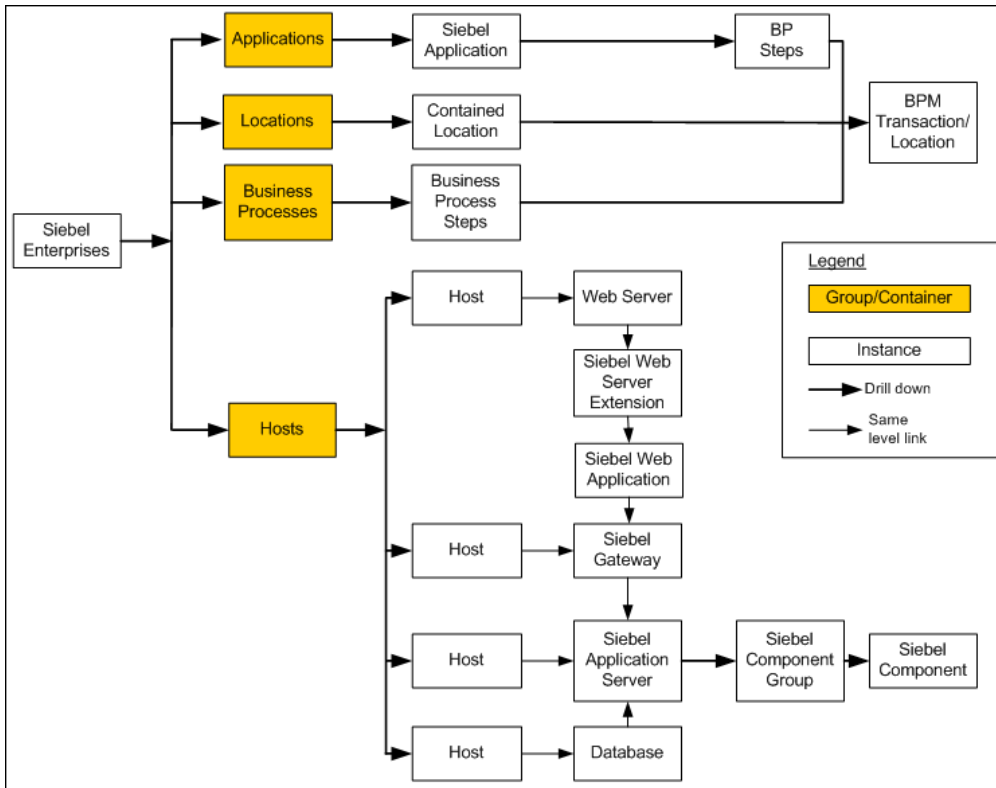

**Note:** The CIs, their hierarchy, and their KPIs are detailed in “Default CITs in the Siebel View” on page 234.

The **Siebel Topology** and **Siebel Web Topology** views are created when you run the discovery job. They display the results of the Siebel discovery and are intermediate views whose information is included in the Siebel Enterprises view.



The Siebel Service uses the **Siebel BPM Locations Linkage**, **Siebel BPM Locations Linkage Automatic**, **Siebel BPM Locations Linkage Manual**, **Siebel Host Monitor Linkage**, and **Siebel SiteScope Measurement Linkage** views to automatically link measurements and monitors to CIs. These views are used for debugging purposes.

In addition, the Siebel Enterprises view includes the following topologies, which are created by specific SiteScope monitors:

► **Siebel Application Server topology discovered by SiteScope:**

SiteScope creates the following topology for the SiteScope Siebel Application Server monitor. The CIs are created only for the monitored entities according to the counters that you selected.

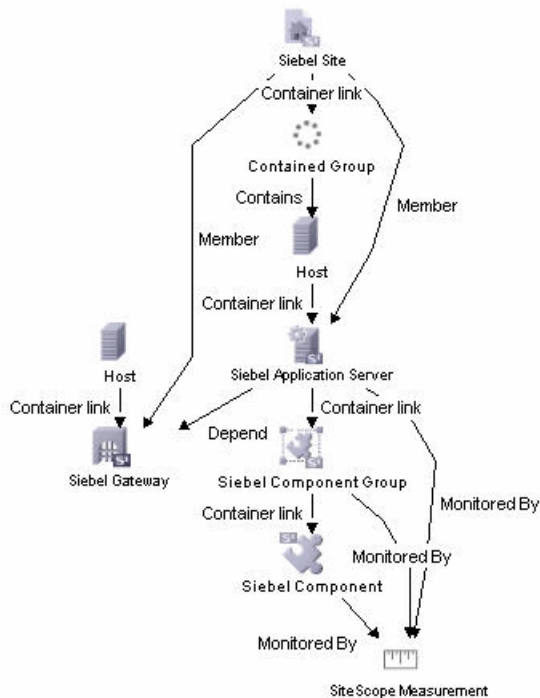

► **Siebel Web Server topology discovered by SiteScope:**

SiteScope creates the following topology for the SiteScope Siebel Web Server monitor. The CIs are created only for the monitored entities according to the counters that you selected.

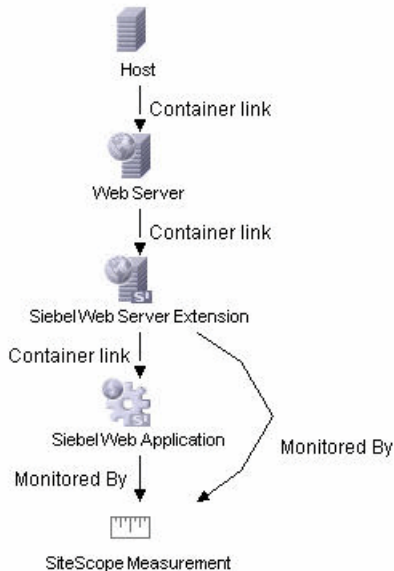

## **Deploy HP Business Availability Center for Siebel Applications – Workflow**

This section describes the processes to follow to view Siebel data in Dashboard, and gives examples.

This task includes the following steps:

- “Prerequisites” on page 195
- “Check the Siebel License in HP Business Availability Center” on page 197
- “Check the Siebel License in SiteScope” on page 197
- “Deploy the Siebel Monitoring Package” on page 197
- “Copy the srvmgr Tool to the DDM Probe Server” on page 198

- “Copy SARM Analyzer and srvmgr Tool to the SiteScope Server” on page 198
- “Perform Discovery” on page 198
- “Configure Specific Siebel CIs Manually” on page 198
- “Change the Business Process Monitor Hierarchy Structure to Transactions/ Locations” on page 198
- “Configure HP Business Availability Center for Siebel Applications” on page 285
- “Activate The Siebel Service” on page 199
- “Modify SiteScope KPI Assignment Group” on page 199
- “Configure HP Business Availability Center for Siebel Applications” on page 199
- “Check That the Deployment Was Successful” on page 199
- “Display Siebel Information in Dashboard” on page 200

## 1 Prerequisites

Ensure that the following software is installed before you install the HP Business Availability Center for Siebel Applications:

- **Requirements.** The requirements are as follows:
  - Siebel 7.5.3, 7.7, or 7.8
  - SiteScope 8.5

---

### Note:

SiteScope monitors are not tested for SiteScope UNIX installation.

If the SiteScope machine is located outside the HP Business Availability Center LAN, you must configure the Virtual Private Network (VPN) to enable SiteScope to communicate with the HP Business Availability Center Gateway Server.

---

- ▶ Business Process Monitor 4.5.2 or later
  - ▶ DDM Probe 6.5
  - ▶ The version of the Siebel Application Response Measurement Analyzer (SARM) package that is appropriate for the Siebel version you have installed. If you are working with SARM in Siebel version 7.8, use SARM Analyzer for Siebel version 7.7.
  - ▶ The Siebel Server Manager version that is appropriate for the Siebel version you have installed.
- ▶ **Support Matrix.**

The support matrix for HP Business Availability Center for Siebel Applications is as follows:

Siebel Version	Solaris Operating System Version (on the Siebel Servers)	Windows Operating System Version (on the Siebel Servers)
<b>Siebel 7.5.3</b>	<ul style="list-style-type: none"> <li>▶ Solaris 5.9 - Supported not tested</li> <li>▶ SARM on mixed environment - Not supported</li> </ul>	Windows 2000
<b>Siebel 7.7</b>	Solaris 9	Windows 2000
<b>Siebel 7.8</b> (to work with SARM you must use SARManalyzer version 7.7)	Solaris 9 - Supported not tested	Windows 2000

- ▶ **DDM Probe.** Used to perform the discovery of Siebel topology in your organization. For details, see *Discovery and Dependency Mapping Guide*.
- ▶ **SiteScope.** Used to integrate the SiteScope data collector into the HP Business Availability Center for Siebel Applications. For details, see the *HP SiteScope Deployment Guide* PDF.

- ▶ **Business Process Monitor.** Used to integrate the Business Process Monitor data collector into the HP Business Availability Center for Siebel Applications. For details, see *HP Business Process Monitor Administrator's Guide*.
- ▶ **Siebel.** Install the applications you want to integrate into HP Business Availability Center. For details, see the Siebel documentation.
- ▶ **Optional - Real User Monitor.** Required to integrate the Real User Monitor Probe to monitor real user traffic and sends it to the RUM engine, that processes and stores it. For details, see “Real User Monitor Administration” in *Using End User Management*.

## **2 Check the Siebel License in HP Business Availability Center**

Check that the appropriate Siebel licenses are set in HP Business Availability Center:

- ▶ The license for running the HP Business Availability Center for Siebel Applications.
- ▶ The license to enable the necessary amount of Business Process transactions to run.

To check that the licenses are set properly or to update the licenses, select **Admin > Platform > Setup and Maintenance > License Management**.

## **3 Check the Siebel License in SiteScope**

Check that the license that enables the definition of SiteScope Siebel monitors and deployment of Siebel solution templates is set properly in SiteScope. For details, see “Siebel Solution Templates” in *Using System Availability Management*.

## **4 Deploy the Siebel Monitoring Package**

Deploy the Siebel Monitoring package. For details, see “Package Manager” in *Model Management*.

## 5 Copy the `svrmgr` Tool to the DDM Probe Server

The `svrmgr` tool is used to extract data about the enterprise's structure from Siebel. To copy the `svrmgr` tool to the DDM Probe server, copy the `svrmgr` Command Line Interface (CLI) tool from the Siebel server to any folder on the DDM Probe server. It is recommended to run the Siebel connection test to validate the `svrmgr` installation. For details, see “Copy the `svrmgr` Tool to the DDM Probe Server” on page 202.

## 6 Copy SARM Analyzer and `svrmgr` Tool to the SiteScope Server

On SiteScope, the `svrmgr` tool is launched by the Siebel Application Server monitor and is used to get the metrics.

SARM Analyzer is used for analyzing SARM data, so that it can be displayed in Business Availability Center for Siebel Applications's SARM - User Trace Breakdown tab.

For details, see “Copy the `svrmgr` Tool and the SARM Analyzer Tool to the SiteScope Server – Details” on page 203.

## 7 Perform Discovery

You run Siebel discovery to discover Siebel elements and Siebel topology. For details, see “Siebel Discovery” in *Discovery and Dependency Mapping Guide*.

## 8 Configure Specific Siebel CIs Manually

When you run the Siebel discovery, the process creates CIs for the discovered components in the CMDB. In addition to the CI's properties that are automatically defined by the discovery process, you must manually define some properties so the Monitor Deployment Wizard and the Siebel diagnostics tools can run correctly. For details, see “Configure Specific Siebel CIs Manually” on page 200.

## 9 Change the Business Process Monitor Hierarchy Structure to Transactions/Locations



Click **Admin > Universal CMDB > Source Manager**, click the **Edit** button for the Business Process source adapter, and change the hierarchy structure to **Transaction/Locations** in the **Hierarchy Structure** parameter.

## 10 Activate The Siebel Service

If you are working with SiteScope 9.0, the Siebel Service starts working after Business Process Monitor and SiteScope source adapters have been synchronized. The Siebel service is automatically activated when you have entered the appropriate license for HP Business Availability Center for Siebel solution. For additional information about the Siebel Service, see “The Siebel Service” on page 190.

For details about how to view a service status with the JMX Web console, see “High Availability for the Data Processing Server” in the *HP Business Availability Center Deployment Guide* PDF. Check that the Siebel Service is activated (it is activated only if you have a license). If necessary activate it manually. For details, see “Check If the Siebel Service Is Activated” on page 220.

## 11 Modify SiteScope KPI Assignment Group

If required, when you are working with SiteScope 9.50, you can modify the existing SiteScope KPI assignments. For details, see “Assignment Groups Page” in *Using Dashboard*.

## 12 Configure HP Business Availability Center for Siebel Applications

To monitor your Siebel eBusiness applications and servers using HP Business Availability Center for Siebel Applications, you must first set up the Siebel monitoring environment. For details, see “Configure HP Business Availability Center for Siebel Applications” on page 211.

## 13 Check That the Deployment Was Successful

Run the predefined tests that check that HP Business Availability Center for Siebel Applications deployment was successful. For details, see “Siebel Deployment Validator Page” on page 264.

For a description of the existing tests and their parameters, see “List of Predefined Tests for Siebel Deployment Validator” on page 266.

To change the default parameters, select **Admin > Platform > Setup and Maintenance > Infrastructure Settings**, choose **Applications**, select **Siebel**, and locate the **Deployment Validator tests definitions** entry in the Siebel - Siebel Deployment Validator table. Modify the parameter values in the XML file.

---

**Note:** You can also create your own tests. For details, see “Create Customized Deployment Validator Tests” on page 228.

---

#### **Example – Check That Deployment is Complete**

Run all the Deployment Validator tests, fix the problems discovered by failed tests, and rerun the failed tests.

#### **Example – Diagnostics Tool (SARM) is Not Working**

Run the Deployment Validator tests in the relevant category, fix the problems discovered by failed tests, and rerun the failed tests.

### **14 Display Siebel Information in Dashboard**

HP Business Availability Center for Siebel Applications is ready. After all these steps are completed, you can view Siebel data in the Dashboard, use diagnostic tools, and so on. For details, see “Display Siebel Information in Dashboard” on page 225.

### **Configure Specific Siebel CIs Manually**

When you run the Siebel discovery, the process creates CIs for the discovered components in the CMDB. In addition to the CI's properties that are automatically defined by the discovery process, you must manually define some properties so the Monitor Deployment Wizard and the Siebel diagnostics tools can run correctly.

You manually define properties in IT Universe Manager. For details on defining properties for a CI, see “CI-Specific Properties” in *IT Universe Manager Administration*.



The following properties remain empty and must be entered manually.

CI Type	Properties	Description
Siebel Enterprise	Admin user name	The name of the user used to login to Server Manager.
	Admin password	The password of the user used to login to Server Manager.
	SARM Script Path	The path to the location of the Siebel Application Response Measurement (SARM) Analyzer package on the SiteScope server. The path is relative to the SiteScope server.
	Server Manager Script Path	The path to the location of Server Manager package on the SiteScope server. The path is relative to the SiteScope server. For details, see “Copy the srvmgr Tool and the SARM Analyzer Tool to the SiteScope Server – Details” on page 203.
Siebel Application	Emulated Transaction User Name	The name of the user used in the script that analyzes the application. It is the default user name that appears when configuring the Database Breakdown tool.
Siebel Web Server Extension	SARM Log Folder	The log folder to which SARM log files are written on the Web Server Extension's machine. The path is relative to the SiteScope server. The folder should be shared. The format should be: \\<siebel_web_server_extension_name>\<log_directory>

CI Type	Properties	Description
Siebel Application Server	SARM Log Folder	The log folder to which SARM files are written on the Application Server machine. The path is relative to the SiteScope server. The folder should be shared. The format should be: \\<siebel_app_server_name>\<log_directory>
	Log Folder	The log folder to which Siebel general log files are written on the Application Server machine. The path is relative to the SiteScope server. The folder should be shared. The format should be: \\<siebel_app_server_name>\<log_directory>

---

**Note:** In addition, you must check that the connection parameters used to connect to SiteScope monitors are the ones that exist in the various relevant CIs (Enterprise, Application Server, and so forth). For details, see “Matching Connection Parameters to SiteScope” on page 277.

---

### Copy the svrmgr Tool to the DDM Probe Server

The svrmgr tool is used to extract data about the enterprise's structure from Siebel.

---

**Note:** If you are working with different versions of Siebel in your organization, make sure you use a svrmgr with a version that is appropriate for the Siebel server.

---

To copy the `srvrmgr` tool to the DDM Probe server, proceed as follows:

- 1 Copy the `srvrmgr` Command Line Interface (CLI) tool from the Siebel server to any folder on the DDM Probe server. It is recommended to run the Siebel connection test to validate the `srvrmgr` installation.
- 2 To run the connection test, open the command line on the DDM Probe server and change directory to the location of the `srvrmgr.exe` file. Run from the command line:  
`>srvrmgr /e [site_name] /g [gateway_host] /u [username] /p [password]`

If the connection is established successfully, you must see the `srvrmgr` prompt and the status message about the number of connected servers, as follows:

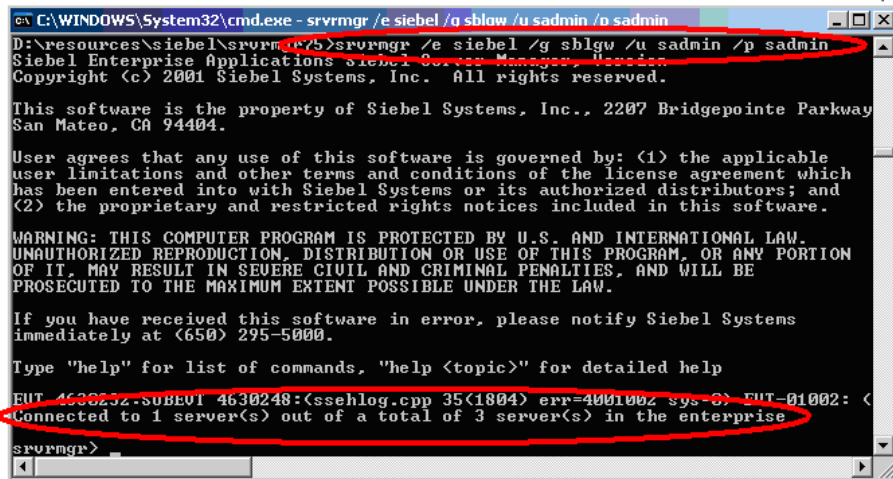

```

C:\WINDOWS\System32\cmd.exe - srvrmgr /e siebel /g sbllw /u sadmin /p sadmin
D:\resources\siebel\srvrmgr > srvrmgr /e siebel /g sbllw /u sadmin /p sadmin
Siebel Enterprise Applications Siebel Service Manager Version
Copyright (c) 2001 Siebel Systems, Inc. All rights reserved.

This software is the property of Siebel Systems, Inc., 2207 Bridgepointe Parkway
San Mateo, CA 94404.

User agrees that any use of this software is governed by: (1) the applicable
user limitations and other terms and conditions of the license agreement which
has been entered into with Siebel Systems or its authorized distributors; and
(2) the proprietary and restricted rights notices included in this software.

WARNING: THIS COMPUTER PROGRAM IS PROTECTED BY U.S. AND INTERNATIONAL LAW.
UNAUTHORIZED REPRODUCTION, DISTRIBUTION OR USE OF THIS PROGRAM, OR ANY PORTION
OF IT, MAY RESULT IN SEVERE CIVIL AND CRIMINAL PENALTIES, AND WILL BE
PROSECUTED TO THE MAXIMUM EXTENT POSSIBLE UNDER THE LAW.

If you have received this software in error, please notify Siebel Systems
immediately at (650) 295-5000.

Type "help" for list of commands, "help <topic>" for detailed help
EUT_463025Z-SUBE01 4630248:(ssehlog.cpp 35(1804) err=400100Z sys-0) EUT-01002: <
Connected to 1 server(s) out of a total of 3 server(s) in the enterprise
srvrmgr>

```

## Copy the `srvrmgr` Tool and the SARM Analyzer Tool to the SiteScope Server – Details

**Note:** If you are working with different versions of Siebel in your organization, make sure you use a `srvrmgr` and a SARM Analyzer with a version that is appropriate for the SiteScope server. For details, see “Context Menu Options” on page 232.

This section provides details about the processes used to copy the `svrmgr` tool and the SARM Analyzer tool to the SiteScope server.

## 1 Copy the `svrmgr` Tool to the SiteScope Server

This section describes how to copy the `svrmgr` tool to the SiteScope server.

- a** Copy the `svrmgr` Command Line Interface (CLI) tool from the Siebel server to any folder on the SiteScope server.

**Note:** It is recommended to run the Siebel connection test to validate the `svrmgr` installation.

- b** To run a connection test, open the command line on the SiteScope server and change directory to the location of the `svrmgr.exe` file.

- c** Run from the command line:

```
>svrmgr /e [site_name] /g [gateway_host] /u [username] /p [password]
```

**Note:** For the connection to work properly you must check that the user and password you are using have the correct permission for a remote connection. For details, see “Perform the Remote Connection from SiteScope to Siebel” on page 205.

If the connection is established successfully, you should see the `srvmgr` prompt and the status message about the number of connected servers, as follows:

```

C:\WINDOWS\System32\cmd.exe - srvmgr /e siebel /g sblgw /u sadmin /p sadmin
D:\resources\siebel\svrmgr>srvmgr /e siebel /g sblgw /u sadmin /p sadmin
Siebel Enterprise Applications Siebel Service Manager, Version
Copyright (c) 2001 Siebel Systems, Inc. All rights reserved.

This software is the property of Siebel Systems, Inc., 2207 Bridgepointe Parkway
San Mateo, CA 94404.

User agrees that any use of this software is governed by: (1) the applicable
user limitations and other terms and conditions of the license agreement which
has been entered into with Siebel Systems or its authorized distributors; and
(2) the proprietary and restricted rights notices included in this software.

WARNING: THIS COMPUTER PROGRAM IS PROTECTED BY U.S. AND INTERNATIONAL LAW.
UNAUTHORIZED REPRODUCTION, DISTRIBUTION OR USE OF THIS PROGRAM, OR ANY PORTION
OF IT, MAY RESULT IN SEVERE CIVIL AND CRIMINAL PENALTIES, AND WILL BE
PROSECUTED TO THE MAXIMUM EXTENT POSSIBLE UNDER THE LAW.

If you have received this software in error, please notify Siebel Systems
immediately at (650) 295-5000.

Type "help" for list of commands, "help <topic>" for detailed help
EUT_4630232.SUBEVI 4630248:(ssehlog.cpp 35(1804) err=4001002 sys=0) EUT-01002: <
Connected to 1 server(s) out of a total of 3 server(s) in the enterprise
srvmgr>

```

## 2 Copy the SARM Analyzer Tool to the SiteScope Server

To copy the SARM Analyzer tool to the SiteScope server, copy the SARM Analyzer tool from the Siebel server to a folder on the SiteScope server.

---

**Note:** If your site includes a large number of Web servers, it is better to use multiple SiteScopes to distribute the work done by the SARM Analyzer tool between these SiteScopes. In such a case, copy SARM Analyzer to each SiteScope.

---

## 3 Perform the Remote Connection from SiteScope to Siebel

All Siebel servers (Windows and UNIX) must be defined as remote servers on the SiteScope server. For details, see the “Microsoft Windows Remote Preferences” or “UNIX Remote Preferences” in *Using System Availability Management*.

## 4 Run the SiteScope Service with a Domain User

SiteScope should run under a domain user who has permissions to run server manager and SARManalyzer and also has read access to the log folders on the Siebel servers (Web servers and application servers).

## Use a Business Process Profile to Simulate Siebel Users

This section provides details about how to use Siebel transactions to simulate Siebel users and obtain performance and availability information on the Siebel application.

You can use Business Process profiles to group several transactions.

### 1 Prerequisites

In the HP Virtual User Generator (VuGen), check that:

- ▶ When recording scripts on VuGen for Siebel, you only use the Siebel-Web protocol. For details see *HP Virtual User Generator User's Guide*.
- ▶ You record scripts with a special user created for monitoring/diagnostics purposes on Siebel.
- ▶ You set a think time separator of 10 seconds for the script transactions used for Siebel diagnostics. The VuGen script includes discrete transactions (transactions that do not include `lr_think_time()` within them) and that it uses the `lr_think_time(...)` functions to separate between the VuGen transactions.
- ▶ The script must not be too long (recommended no more than five transactions per script) since the Diagnostics tools need to run the whole script every time you want to analyze a specific transaction. For example, if a problematic transaction is located close to the end of the script, you would have to run all the previous transactions to reach the problematic one. If you need to record more transactions, record an additional script.
- ▶ Optionally, the Run-Time Settings should be configured for setting appropriate values: **Think-Time-Replay policy**, **Timeout values**, logging options, **Proxy**, **Browser Emulation**, and so on.

You can only use Vugen scripts with Siebel applications.

## 2 Select the Appropriate Protocol

You must select the Siebel-Web protocol when you create a new script, because, in HP Virtual User Generator (VuGen), Siebel scripts are recorded using the Siebel-Web protocol. For details, see *HP Virtual User Generator User's Guide*.

In HP Business Availability Center, you can attach Business Process Monitor transactions to Siebel application components automatically or manually. For details, see “Specify a Transaction/Location or Regular Hierarchy in the Business Process Monitor Source Adapter” on page 208.

To select the appropriate protocol:

- a** In VuGen, select **New** to open the New Virtual User page.
- b** Select **New Single Protocol Script**.
- c** Select the **Siebel-Web** protocol.

## 3 Create a Business Process Profile

You can create business process profiles in End User Management. For details, see “Managing Business Process Profiles Overview” in *Using End User Management*.

## 4 Synchronize the Business Process Monitoring Source Adapter to Enter Business Process Monitor CIs in the CMDB

To view data in the Siebel Enterprises view in Dashboard, the Business Process Monitor source adapter must be synchronized.

You can synchronize the Business Process Monitoring source adapter immediately or you can wait for the automatic synchronization to take place.

For details, see the action buttons in “Source Manager Page” in *Model Management*.

## 5 Specify a Transaction/Location or Regular Hierarchy in the Business Process Monitor Source Adapter

To display location information in the Siebel view(s), select the **Transaction/Location** type of hierarchy to the Business Process Monitor source adapter. To hide location information, select the **Regular** type of hierarchy. For details about the option, see “Template Elements” in *Model Management*.

### Attach Business Process Monitor Transactions to Siebel Application Components

To display Performance and Availability information on Siebel applications, you must attach Business Process Step CIs to Siebel Application CIs.

If the Business Process Monitor source adapter was assigned the **Transaction/Location** option a copy of the location information is attached to the Locations container. For details about the option, see “Template Elements” in *Model Management*.

You can connect Business Process Steps to a Siebel application in two ways:

- Follow the naming conventions for Siebel Business Process Steps names.
- Do **not** follow the naming conventions for the Business Process Steps names. In this case, you must manually link a Business Process Step to a Siebel application.

For details, see “Specify a Transaction/Location or Regular Hierarchy in the Business Process Monitor Source Adapter” on page 208.

If you do not follow the naming conventions, be careful when deleting links between Siebel applications and Business Process Steps. For details, see “Delete Links Between Siebel Applications and Business Process Steps” on page 216.



## Automatically attach Business Process Steps to a Siebel Application CI by Following the Naming Convention

To automatically connect Business Process Steps to a Siebel application, use the following format for the Business Process Step names:

`<app_name>_<ent_name>_<BPM_tran_name>`

- **app\_name.** The name of the Siebel application to which you want to attach the Business Process Step.
- **ent\_name.** The name of the Siebel Enterprise on which the Siebel application is run.
- **BPM\_tran\_name.** The unique name of the Business Process Step.

Any set of alphanumeric and mixed case characters are supported (special characters are not allowed). It is good practice to name the transaction so that the name indicates what occurs in it.

Make sure the double underscore do not have spaces between them.

---

**Note:** You assign the appropriate name to a Business Process Step when you record it. For details, see *HP Virtual User Generator User's Guide*.

---

## Attach Business Process Steps to a Siebel Application CI Without Following the Naming Convention

After you have built a Business Process profile, you must manually connect Business Process Steps with Siebel Application CIs. To attach Business Process Steps to a Siebel Application CI without following the naming convention:

- a** Select **Admin > Universal CMDB > Modeling > IT Universe Manager**.
- b** Select **Siebel Enterprises** in the **View** list.
- c** Right-click the Siebel Application CI that you want to monitor using the BPM profile and select **Attach Monitoring CI** to open the **Attach Related CIs** wizard. For details, see “Attach Related CIs Wizard” in *Model Management*.
- d** Select **End User Monitors View** in the **Views** list.

**e** Expand and select the Business Process Step to which you want to connect the Siebel Application CI. You can select more than one.



**f** Click the right arrow to move the CI to the right-hand box.

**g** Click **Next**.

**h** In the **Relationship Type** list, select **Monitoring By Siebel**.

**i** Select **Allow CI Update**.

**j** Click **Finish**.

## 6 Deploy the SiteScope Siebel Monitors

Deploy the SiteScope Siebel monitors. For details, see “Deploy the SiteScope Siebel Monitors” on page 216.

## 7 View SARM Data in Business Process Steps

To view Siebel Application Response Measurement (SARM) data in Business Process Steps in the HP Business Availability Center for Siebel Applications SARM - User Trace Breakdown diagnostics tool, you must select the **Enable Siebel Breakdown** property for each Siebel transaction monitor in the Business Process profile. When you do not select the property, the Transactions tab is empty.

To see SARM data under Business Process Steps, select **Admin > End User Management**, right-click the relevant transaction monitor and select **Edit**, and in the Transaction Breakdown Settings area, select the **Enable Siebel Breakdown** parameter.

The screenshot shows the 'Edit Transaction Monitor' configuration page for 'siebe...l03\_2'. The page is divided into several sections:

- Transaction Monitor Details:** A table with columns: Name, Description, Creation Date, Modification Date, Version, Path. The entry is 'siebel\_labm1sbl03\_2' with creation date 5/30/06 12:00 AM and modification date 5/30/06 7:15 PM. Below this is a 'Reload script version' dropdown set to '1.1.1' and a 'Script Repository' link.
- Data Collectors Assignment Settings:** A table with columns: Location, Host, Group, Version, Schedule. Two entries are shown: 'eschulman2-il' (Host: eschulman2-il, Version: 6.1.0.0) and 'rca1' (Host: rca1, Group: Group1, Version: 6.0.0.0, Schedule: Every 15 minute(s), all week, all day, Offset:-1). The 'rca1' entry is checked.
- Transaction Breakdown Settings:** A list of checkboxes:
  - Enable breakdown
  - Report additional error information
  - Perform component breakdown
  - Enable diagnostics breakdown
  - Enable Siebel breakdown
- Transaction Threshold Settings:** A collapsed section.
- Transaction Description Settings:** A collapsed section.
- Category Settings:** A collapsed section.

## Configure HP Business Availability Center for Siebel Applications

This section describes the detailed steps used to configure the Siebel monitoring environment.

This task includes the following steps:

- ▶ “Create Business Process Profiles That Emulate Siebel Application Users” on page 212
- ▶ “Deploy SiteScope Monitors for the Siebel Templates Using the Monitor Deployment Wizard” on page 212

- ▶ “Go Through the Diagnostics Checklist” on page 212

### **1 Create Business Process Profiles That Emulate Siebel Application Users**

You can use Siebel transactions to simulate Siebel users and obtain performance and availability information on the Siebel application. You use Business Process profiles to group several transactions.

For information on creating Business Profiles, see “Use a Business Process Profile to Simulate Siebel Users” on page 206.

### **2 Deploy SiteScope Monitors for the Siebel Templates Using the Monitor Deployment Wizard**

You can use SiteScope monitors to monitor Siebel. For more information about the monitors, see “Siebel Monitors” on page 189.

For details about deploying the SiteScope Siebel monitors, see “Deploy the SiteScope Siebel Monitors” on page 216.

### **3 Go Through the Diagnostics Checklist**

Check that the Diagnostics-related settings correctly set up to ensure that Diagnostics work properly.

For details, see “Verify Diagnostics-Related Settings” on page 212.

## **Verify Diagnostics-Related Settings**

This section provides details about the Diagnostics-related settings that ensure that Diagnostics work properly.

This task includes the following steps:

- ▶ “Check the Diagnostics-Related Settings for Siebel” on page 213
- ▶ “Check the Diagnostics-Related Settings for SiteScope” on page 213
- ▶ “Diagnostics-Related Settings for HP Business Availability Center” on page 214

## 1 Check the Diagnostics-Related Settings for Siebel

Check that:

- The SiteScope user has at least read-only access to the log directories of all Web and Application Servers.
- The SiteScope user has administrative privileges on all Siebel servers or, if this is not possible, give the permissions specified at the Microsoft Help and Support site (<http://support.microsoft.com/default.aspx?scid=kb:en-us:Q300702>).
- You have defined a special Siebel user to be used by Business Process Monitor profiles. This user should be used only for that purpose.
- **Siebel Breakdown** is enabled for the script that monitors the Siebel application. For details, see “Managing Business Process Profiles Overview” in *Using End User Management*.
- **Siebel Server Manager and SARM Analyzer**. Check that:
  - The **svrvmgr** package and **SARM Analyzer** package are installed on a SiteScope machine (they are needed for running the Diagnostics tools). You copy Siebel Server Manager and the SARM Analyzer to a SiteScope machine (preferably) or, if this is not possible, to another machine where it can be executed by a SiteScope user. For details, see “Copy the svrvmgr Tool and the SARM Analyzer Tool to the SiteScope Server – Details” on page 203.
  - The SiteScope user on Siebel Server Manager has execution permissions when both SiteScope and Siebel are running on UNIX.

## 2 Check the Diagnostics-Related Settings for SiteScope

Check that:

- SiteScope service is running under a domain account (not a local system). This domain account (SiteScope user) must have the permissions specified in “Check the Diagnostics-Related Settings for Siebel” on page 213.
- Each Siebel Web and Application Server is defined as Remote NT or Remote UNIX appropriately. Remote UNIX machines must be defined using the Telnet protocol. Additionally, in the **initialize shell environment** field, enter **stty cols 1024; stty tabs; \$SHELL**.

- ▶ SiteScope has access permissions to the Siebel machines. Check that the account SiteScope Service is running in Services (in Windows NT) or in the process (on UNIX).
- ▶ The **log** and **SARM log** folders on Siebel Web Server and Application Server are accessible from the SiteScope machine.
- ▶ SiteScope is attached to the Gateway Server.
- ▶ SiteScope has an additional license for Siebel Monitors.

### 3 Diagnostics-Related Settings for HP Business Availability Center

Check that:

- ▶ All the HP Business Availability Center for Siebel Applications configuration parameters of the Enterprise, and Siebel Servers are spelled correctly, the appropriate case is used, and there are no blank spaces at the end of the parameter string.
- ▶ There is no inconsistency in the treatment of the SiteScope host name between the SiteScope profile and System Availability Management (either defined with domain or as an IP address). Also, check that SiteScope can communicate with the Siebel server.

Diagnostics cannot access a SiteScope located in an outer LAN. The solution is to define SiteScope in System Availability Management using the host name provided by the SiteScope server. If the SiteScope server cannot be accessed using such a host name from the Gateway Server the host name must be defined in the hosts file in the operating system of all the Gateway Servers (for Windows NT, the location is:

**C:\WINNT\system32\drivers\etc\hosts**; for some UNIX environments, the location is: **/etc/hosts**; in other UNIX environments it is in the **.rhosts** file).

- ▶ The SiteScope you are using for diagnostics is attached (click **Admin > System Availability Management** in HP Business Availability Center).
- ▶ You are using a dedicated SiteScope for diagnostics purposes, when working with medium to large Siebel deployments.

- ▶ The time zone and time definitions of the SiteScope server used for diagnostic purposes (on which SARM Analyzer and srvmgr are installed) are synchronized with the Siebel server time zone and time definition.
- ▶ You have network access (without firewalls or through VPN) to the Business Process Monitor servers (port **2696**) you are going to use for diagnostics purposes.
- ▶ For each Business Process Monitor server used for Diagnostics, you can open the **http://<BPM\_server>:2696/** page from the Gateway Server.
- ▶ All paths you set in HP Business Availability Center for Siebel Applications configuration are relative to SiteScope; for example: if they are local on SiteScope (Server Manager, SARM analyzer) use the local path, otherwise use the complete network path.
- ▶ You have a license for Siebel on the Gateway Server (select **Admin > Platform > Setup and Maintenance > License Management** to verify this).
- ▶ SiteScope data arrives to HP Business Availability Center.

Consult the **dispatcher.txt** log file with the appropriate log level to check that information. You can update the log level of the dispatcher log in the first line of the

**<HP Business Availability Center root directory>**

**\conf\core\DataService\DataService\_logs.ini\dispatcher\_log.cfg** file on the Gateway Server. Change the value of **LogLevel** to **debug5**. This causes the samples from SiteScope to appear in the **dispatcher.txt** file.

For details about SiteScope samples, see “Data Samples for SiteScope” in *Reference Information*.

---

**Note:** It is recommended to increase the log level only for a short period, so HP Business Availability Center performance is not affected.

---

- ▶ The user of your Siebel Application in HP Business Availability Center for Siebel Applications Configuration has appropriate permissions in the Siebel Site and the password is correct.

## Delete Links Between Siebel Applications and Business Process Steps

If you delete a link between a Siebel Application CI and its child Business Process Step transaction, then the following happens:

- ▶ If you follow the naming convention for the Business Process Step transaction, the link between the Siebel transaction and its child Business Process Step is automatically recreated at the next synchronization.
- ▶ If you do not follow the naming convention and created a manual link between the Siebel transaction and a Business Process Step transaction, then when you delete the link:
  - ▶ If the Business Process Monitoring source adapter was assigned the **Transactions/locations** option, the Contained Location CI is not deleted.

Delete the Contained Location CI only if the deleted Business Process Step transaction is the only CI attached to this location. If other Business Process Step transactions are attached to this location, delete only the links between the Business Process Monitor (BPM transaction from location) and the Location container.

- ▶ If the Business Process Monitoring source adapter was assigned the **Regular** option, the link between the BP Step and the BP Steps container is not automatically deleted, and you should delete it.

For details about the **Transactions/locations** or **Regular** options, see “Template Elements” in *Model Management*.

## Deploy the SiteScope Siebel Monitors

This section provides the detailed steps to use to deploy SiteScope Siebel monitors.

You can deploy the Siebel monitors using the Monitor Deployment Wizard or the Siebel solution templates.



Both techniques leverage the concept of solution sets. Solution sets automate the creation of the monitors that should be used, and include built-in threshold information. Essentially, they encompass monitoring best practices.

The task includes the following steps:

- ▶ “Use the Monitor Deployment Wizard” on page 217
- ▶ “Using the Siebel Solution Templates” on page 219
- ▶ “Synchronize the SiteScope Source Adapter to Enter SiteScope CIs in the CMDB” on page 219

## 1 Use the Monitor Deployment Wizard

Use the Monitor Deployment Wizard to deploy Siebel monitors. For details, see “Monitor Deployment Wizard” in *Using System Availability Management*.

In the Monitor Deployment wizard, in the left pane of the Select Configuration Items to Monitor page, select the **Siebel Enterprises** view. Select the CIs you would like monitored and move them to the right pane. In the Select Templates to Apply page, the left pane lists all the available templates in the wizard. The names of the Siebel-specific templates start with Siebel. The child objects are the monitors that are deployed by the template. The right pane lists the CI Types of all the CIs selected in the previous page.

If the wizard is able to match templates to the selected CI Types, the CI Type is listed with the applicable template as a child object:

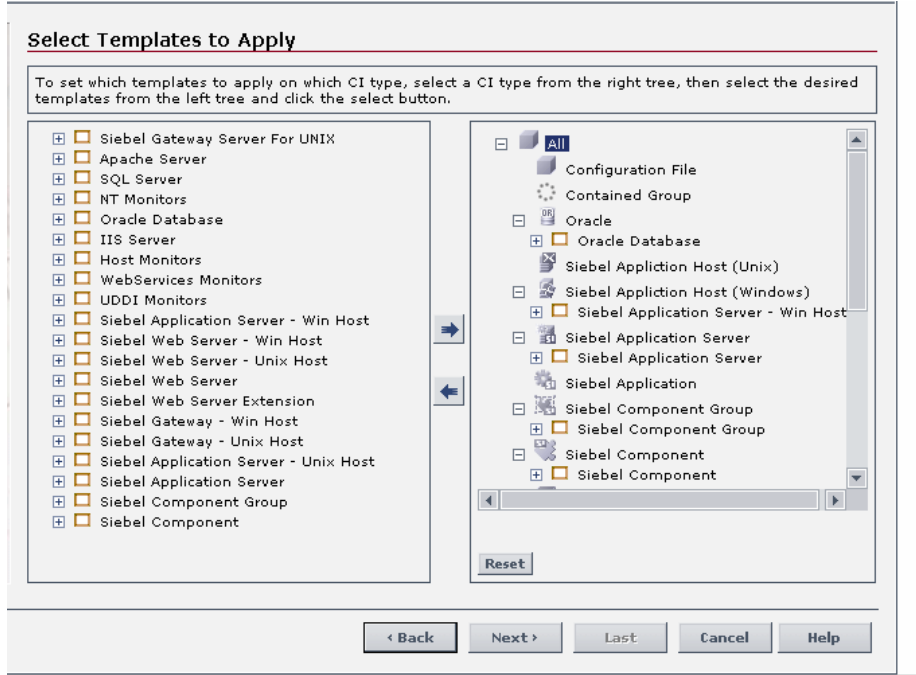

---

**Note:** When deploying monitors on Siebel objects, the CI Types appearing in the right pane may be Siebel CI Types.

---

## 2 Using the Siebel Solution Templates

To create a SiteScope monitor that can monitor a Siebel Enterprise, you can run dedicated solution templates. Two kinds of solution templates are available for each solution (one for UNIX and one for Windows):

Solution Templates For Unix	Solution Templates For Windows	Description
Siebel Appl Server for UNIX	Siebel Appl Server For Windows	Deploy a set of monitors that test both Siebel-specific and general statistics on the Siebel Application servers.
Siebel Gateway Server For UNIX	Siebel Gateway Server For Windows	Deploy a set of monitors that test machine and OS-oriented statistics of Siebel Gateway servers.
Siebel Web Server For UNIX	Siebel Web Server For Windows	Deploy a set of monitors that test both Siebel-specific and general statistics on Siebel Web servers installed.

For details about running the solution template, see “Siebel Solution Templates” in *Using System Availability Management*.

## 3 Synchronize the SiteScope Source Adapter to Enter SiteScope CIs in the CMDB

If you are working with SiteScope 9.0, to view data in the Siebel Enterprises view in Dashboard, the SiteScope source adapter must be synchronized.

You can synchronize the SiteScope source adapter immediately or you can wait for the automatic synchronization to take place.

For details, see the action buttons in “Source Manager Page” in *Model Management*.

## Check If the Siebel Service Is Activated

This section explains how to check if the Siebel Service is activated.

The Siebel Service is a configuration service for automatic linkage. For details, see “The Siebel Service” on page 190.

The Siebel Service starts working after BPM source adapter and SiteScope source adapter (if you are working with SiteScope 9.0) have been synchronized. The Siebel service is automatically activated when you have entered the appropriate license for HP Business Availability Center for Siebel Applications.

Check that the Siebel Service is activated (it is activated only if you have a license). If necessary activate it manually. For details about how to view a service status with the JMX Web console, see “High Availability for the Data Processing Server” in the *HP Business Availability Center Deployment Guide* PDF.

---

**Note:** If you enter a new license in an old HP Business Availability Center installation, you may need to restart the Modeling server to activate the service.

---

### To view if the Siebel Service is activated:

- 1 In the browser, enter, using JMX login credentials:  
**http://<HP Business Availability Center server name>  
:8080/jmx-console/**
- 2 Double-click **service=hac-manager** listed under **Topaz**.
- 3 In the JMX MBean View for hac-manager that opens, click the **Invoke** button corresponding to the **listAllAssignments** parameter.

## Run the Siebel Database Breakdown Diagnostic Tool

This section provides details about running the Siebel Database Breakdown diagnostics tool.

When the user runs Database Breakdown, after defining the analysis scope (Siebel Enterprise, Application, Business Process Step, and so on), HP Business Availability Center for Siebel Applications automatically increases (through SiteScope) the database log level for the selected component (if a specific component was selected).

Then, HP Business Availability Center for Siebel Applications instructs the Business Process Monitor to run the transaction you selected. During the transaction run, as a result of the higher log level, database-related information is written into the application server log.

When the transaction has finished running, the database log level for the selected component is returned to normal by HP Business Availability Center for Siebel Applications.

To run the Database Breakdown tool, select **Applications > Business Availability Center for Siebel > Database Breakdown** to open the Siebel Database Breakdown Configuration page. For details, see “Siebel Database Breakdown Configuration Report” on page 259.

You can also access this page filtered for the selected CI, when you right-click the CI and select the **Siebel Database Breakdown** option. For details, see “Customize Dashboard Display and Refresh Rate” in *Using Dashboard*.

## Run the SARM - User Trace Breakdown Diagnostics Tool – Details

This section describes how to run the SARM - User Trace Breakdown diagnostics tool.

You can view data about the activity taking place in the Web server(s) and application server(s) at a specific Siebel Enterprise and for a specific user, in a specified period of time. HP Business Availability Center searches all of the SARM files at the Siebel Enterprise, looks for the sessions of the specified user, fetches the appropriate files, runs the SARM analyzer, and lists all of the sessions used by the user.

The task includes the following steps:

- “Configure the SARM - User Trace Breakdown Diagnostic Tool” on page 222
- “Use the SARM Logs for a Specific Web and Application Server” on page 224
- “Results” on page 224

## 1 Configure the SARM - User Trace Breakdown Diagnostic Tool

To configure the SARM - User Trace Breakdown diagnostics tool, select **Applications > Business Availability Center for Siebel > SARM - User Trace Breakdown to open the SARM - User Trace Breakdown Diagnostic Tool** page. For details, see “SARM - User Trace Breakdown (Run the Diagnostics Tool) Page” on page 241.

### Example

The screenshot shows the 'SARM - User Trace Breakdown' diagnostic tool interface. At the top, there are tabs for 'SARM - User Trace Breakdown', 'Database Breakdown', 'Tasks', and 'Process'. Below the tabs, the main content area is titled 'SARM - User Trace Breakdown'. It contains several input fields: 'Enterprises:' with a dropdown menu showing 'siebel', 'User:' with an empty text box, 'From:' with a date and time 'May 17 2006 10:42:32 AM', and 'To:' with a date and time 'May 17 2006 10:52:32 AM'. Below these fields, there are two expandable sections: 'Invoke Business Process Monitor Script' and 'Advanced Options', each with a downward-pointing arrow icon.

Select the Siebel Enterprise for which you want to view SARM User Trace Breakdown data, enter the name of the user whose activity you want to trace in the User box, and click the linked date in **From** or **To** to open a calendar. Select a new date and time to change the default date and time.

After you configure the SARM, you can:

- ▶ **Invoke a specific Business Process Monitor script.** You can view data about a Business Process Monitor transaction of a specific script running in the Web server(s) and application server(s) at a specific Siebel Enterprise, and in a specified period of time. HP Business Availability Center invokes the Business Process Monitor transaction, and then analyzes the relevant session. For details, see “Invoke Business Process Monitor Script” on page 243.

Invoke Business Process Monitor Script

Application:  Script:  Host:

Transactions:

```
login_cannon_aviad_bpm1
goto_accounts_cannon_aviad_bpm1
goto_assets_cannon_aviad_bpm1
goto_orders_cannon_aviad_bpm1
logout_cannon_aviad_bpm1
```

- ▶ Specify where the files can be found:
  - ▶ **Automatically collected Web and application server logs.** You can run the SARM - User Trace Breakdown diagnostic tool on automatically collected Web and application server logs.
  - ▶ **The SARM logs of a specific application server and Web server.** You can run the SARM - User Trace Breakdown diagnostic tool on the SARM logs of a specific application server and Web server.
  - ▶ **An already generated user session trace XML file for a Siebel Enterprise, a user, and a specific time frame.** You can run the SARM - User Trace Breakdown diagnostic tool on an already generated user session trace XML file for a site, a user, and a specific time frame. HP Business Availability Center searches all of the SARM files at the Siebel Enterprise, looks for the sessions of the specified user, fetches the appropriate files, runs the SARM analyzer, and lists all of the sessions used by the user that were active within the time frame.

For details, see “Advanced Options Area” on page 243.

Advanced Options

Analyze data in files:

- Automatically collect files.
- Specify the SARM logs folders:
  - Application Servers:
  - Web Servers:
- Specify a User Session Trace File:
  - User Session Trace File:

---

Using SiteScope:

You can then run the diagnostic tool.

## 2 Use the SARM Logs for a Specific Web and Application Server

Run the SARM - User Trace Breakdown diagnostic tool, the SARM - User Trace Breakdown page indicates the status of each step in the procedure. For details, see “SARM - User Trace Breakdown Dialog Box” on page 244.

After the process is complete, the page closes and the diagnostic results are displayed on the SARM - User Trace Breakdown - Analysis page.

## 3 Results

The data is then displayed and you can generate different views and pie charts to display the data in a user-friendly manner in the SARM - User Trace Breakdown page. For details, see “Siebel Views” on page 191.



## Display Siebel Information in Dashboard

HP Business Availability Center for Siebel Applications is ready. After all these steps are completed, you can view Siebel data in the Dashboard, use diagnostic tools, and so on. You can display Siebel information in Dashboard as follows:

- ▶ **View Siebel information in the Siebel views.** For details about the views, see “Siebel Views” on page 191.

To enable the other Siebel views, select **Dashboard & Service Level Management** in the View Properties dialog box. For details, see “Create New View/View Properties Dialog Box” in *Model Management*.

- ▶ **View the SARM - User Trace Breakdown Diagnostic report.** HP Business Availability Center for Siebel Applications SARM Diagnostics is a user trace breakdown diagnostic tool that processes the data in the User Session Trace output files produced by Siebel’s SARM process. This data can be retrieved for a specific user in a specific time frame. It can also be retrieved for a specific transaction of a prerecorded script.

To run the tool, see “Run the SARM - User Trace Breakdown Diagnostics Tool – Details” on page 221.

To display the information, see “Siebel Views” on page 191.

- ▶ **View the Siebel Database Breakdown Diagnostic report.** The Siebel Database Breakdown diagnostic tool enables you to analyze database logs created on the Siebel application server, and extract comprehensive information regarding database time spent by various SQLs.

To run the tool, see “Run the Siebel Database Breakdown Diagnostic Tool” on page 221.

To display the information, see “Siebel Database Breakdown Analysis Report” on page 262.

- ▶ **View the Tasks Diagnostics Tool report.** The Siebel tasks diagnostic tool enables you to view details of the Siebel Application Server tasks, for each monitored Siebel Enterprise. For details, see “Tasks Diagnostics Tool Report” on page 271.
- ▶ **View the Processes Tool report.** The Siebel Processes tool enables you to view details of the Siebel Application Server processes, for each monitored Siebel Enterprise. For details, see “Processes Report” on page 238.
- ▶ **View Changes Made to Siebel Enterprise CIs.** You can assign CIs to keep change information. For details on assigning CIs to keep change information, see the HP Universal CMDB documentation.

When the discovery process discovers changes made to the properties of these CIs, the changes are displayed in the Change report available as a context menu option for each one of the relevant CI types. For details about the Change report, see “Change Report Page” in *Model Management*.

- ▶ **View Configuration File CI Details.** For details, see “View Configuration File CI – Details” on page 227.

## View Configuration File CI – Details

You can view configuration file details:

- **siebel.cfg file.** Right-click the relevant Siebel Application Server CI in the Siebel Enterprises view, select **Properties**, and click **Show document content** to display the details of the **siebel.cfg** file. The **siebel.cfg** configuration file displays information taken from the application server installation.

```

siebel (read-only)
[Internet]
TableOwner      = SIEBEL
SqlStyle        = OracleCBO

[ISSCDA]
ISSCDAProdDetBusCompName = Internal Product
ISSCDAProdDetBusObjName  = Internal Product
ISSCDAProdDetViewName    = Product Detail Key Features View
ISSCDAHeaderBusObjName   = Quote
ISSCDAHeaderBusCompName  = Quote
ISSCDAIntegrationObjName = Quote
ISSCDAListItemBusCompName = Quote Item
ISSCDAHeaderViewName     = Quote Detail View
ISSCDAGetMyPriceFields   = List Price,Product Name,Current Price,Pricing Comments,Net Price,Start Price

[Wireless:ApplicationList]
Siebel Sales Wireless      = WirelessSalesObjMgr_enu
Siebel Service Wireless    = WirelessServiceObjMgr_enu
Siebel PRM Wireless        = WirelessChannelObjMgr_enu
;;Siebel eService Wireless = WirelessServiceObjMgr_enu

```

- ▶ **parameters.cfg file.** Right-click the relevant Configuration File CI in the Siebel Enterprises view, select **Properties**, and click **Show document content** to display details of the **parameters.cfg** file. The **parameters.cfg** file includes the output of the **list parameters for component** command using **svrmngr**.

PA_ALIAS	PA_VALUE	PA_DATATYPE	PA_SCOPE	PA_SUBSYSTEM	PA_SETLEVEL	PA_DISP_SETLEVEL
16KtlSpace		String	Subsystem Database Access	Never set	Never set	Y N N N 16K Tak
32KtlSpace		String	Subsystem Database Access	Never set	Never set	Y N N N 32K Tak
ActuateConnStr		String	Subsystem Infrastructure Actuate Reports	Never set	Never set	Y N N N Act
ActuateProtocolName		String	Subsystem Infrastructure Actuate Reports	Never set	Never set	Y N N N A
ActuateReportCastDomain	CHANGE_ME	String	Subsystem Infrastructure Actuate Reports	Server level	Server level set	
ActuateReportCastHost		String	Subsystem Infrastructure Actuate Reports	Never set	Never set	Y N N N .
ActuateReportCastLang	LANG_INDEPENDENT	String	Subsystem Infrastructure Actuate Reports	Server level	Server level set	
ActuateReportPollWait	30	Integer	Subsystem Infrastructure Actuate Reports	Server level	Server level set	Y N N P
ActuateReportServerHost		String	Subsystem Infrastructure Actuate Reports	Never set	Never set	Y N N N
ActuateRequestPollInterval	10,0,0,10	String	Subsystem Infrastructure Actuate Reports	Default value	Default value	Y N I
ActuateRoxDir	/Siebel Reports/	String	Subsystem Infrastructure Actuate Reports	Server level	Server level set	Y N N
ActuateServerEnabled	False	Boolean	Subsystem Infrastructure Actuate Reports	Default value	Default value	Y N I
AddToCartAutoQuote	TRUE	String	Subsystem Infrastructure Shopping Servic	Default value	Default value	Y N N
AddToCartGotoView	NONE	String	Subsystem Infrastructure Shopping Servic	Default value	Default value	Y N N
AnonLogin	False	Boolean	Subsystem Object Manager	Default value	Default value	Y N N N OM-
AnonymousQuote	FALSE	String	Subsystem Infrastructure Shopping Servic	Default value	Default value	Y N N
AssetBasedOrderingEnabled	False	Boolean	Subsystem Object Manager	Default value	Default value	Y N N
AutoQuoteDefaultOwner	TRUE	String	Subsystem Infrastructure Shopping Servic	Default value	Default value	Y N
AutoRestart	True	Boolean	Subsystem Process Management	Default value	Default value	Y N N N Ai
BusinessServiceQueryAccessList		String	Subsystem Object Manager	Never set	Never set	N N N N
CACertFileName		String	Subsystem Networking	Never set	Never set	N N Y N CA certifi
CCAEnable	False	Boolean	Subsystem Infrastructure CCA subsystem	Default value	Default value	Y N N N
CCAMerchantId	esalestest	String	Subsystem Infrastructure CCA subsystem	Default value	Default value	Y N N
CCAServerHost	ics2test.ic3.com	String	Subsystem Infrastructure CCA subsystem	Default value	Default value	Y N

You can also access this information by selecting **Admin > Universal CMDB > Modeling > IT Universe Manager > Properties**. For details, see “Properties Dialog Box” in *Model Management*.

## Create Customized Deployment Validator Tests

You can create customized Deployment Validator tests and add them to the existing list of tests or replace existing tests with your own.

**To create a customized Deployment Validator test:**

- 1 Create a Java class that checks the problem.
- 2 Create a resource file and save it in the following directory:  
**<HP Business Availability Center source directory>\AppServer\resources.**

- 3 Add the test definition to the list of tests. To add a test, select **Admin > Platform > Setup and Maintenance > Infrastructure Settings**, choose **Applications**, select **Siebel**, and open the XML file associated with the **Deployment Validator test definitions** entry in the Siebel - Siebel Deployment Validator table and add or remove tests.

For example, a typical test entry is as follows:

```
<test
class="com.mercury.topaz.siebel.admin.deployment.validator.backend.tests.SiebelPackageDeploymentTest" resources="siebel.package.deployment.test"/>
```

It includes the name of the class and the name of the test resource file. The resource file includes the name of the test, description, category, error messages, and so forth.

For example, a typical resource file format is as follows:

```
# SiebelEnterprisesViewTest properties
siebel.enterprises.test.name=Siebel Enterprises View Test
siebel.enterprises.test.desc=Checks that the Siebel Enterprises view contains Siebel Enterprises with descendants Siebel Application Server, Siebel Web Server Extension and Siebel Gateway
siebel.enterprises.test.category=BAC
siebel.enterprises.test.no.site=No Siebel Enterprise CI was found.
siebel.enterprises.test.no.site.specific=Siebel Enterprise &#39;{0}&#39; was not found.
siebel.enterprises.test.not.valid.site=Siebel Enterprise &#39;{0}&#39; doesn&#39;t have descendant {1}.
```

- 4 Save and restart HP Business Availability Center.

---

**Note:** When you add or remove a test in the Deployment Validator test definitions XML file, the previous test results are discarded and you must rerun the complete list of tests.

---

## **Customize HP Business Availability Center for Siebel Applications**

You can customize HP Business Availability Center for Siebel Applications using the capabilities listed in this section.

The task includes the following topics:

- “Save the Generated XML Files After Generating the SARM Report” on page 230
- “Specify the Default SiteScope Monitors” on page 231
- “Specify the SiteScope Monitor Used to Execute Siebel Diagnostics Tools” on page 231
- “Change the Default Timeout for the Execution of a SiteScope Monitor” on page 231
- “Increase the Default Timeout for Either a SARM Task or a SARM Analyzer Execution” on page 232

### **1 Save the Generated XML Files After Generating the SARM Report**

After the generation of the SARM report, the generated XML files are automatically deleted from the SiteScope and HP Business Availability Center.

To prevent the deletion and save the generated XML files after generating the SARM report, select **Admin > Platform > Setup and Maintenance > Infrastructure Settings**, choose **Applications**, select **Siebel**, and locate the **Siebel - Siebel SARM Breakdown** area. Modify the following parameters:

- **Remove SARM results temporary directory from BAC.** If you give this parameter the value **false**, then the XML files are saved in the `<HP Business Availability Center center server>\AppServer\webapps\site.war\imgs\chartTemp\offline` directory.
- **Remove SARM results temporary directory from SiteScope.** If you give this parameter the value **false**, then the XML files are saved in the `<SiteScope installation directory>\cache\tempbyage\  
<TimeStamp>_SIEBEL_SARM\  
<web_server>_<App_server>` directory.

## 2 Specify the Default SiteScope Monitors

Specify the default SiteScope monitors you want to work with.

To specify the default SiteScope monitors, select **Admin > Platform > Setup and Maintenance > Infrastructure Settings**, choose **Applications**, select **Siebel**, and locate the **Default SiteScopes for SARM diagnostics** entry in the Siebel - Siebel SARM Breakdown table. Modify the value by entering one of the following:

- The SiteScope monitor names separated by semicolons (for example: rca3;rca4)
- **ALL** to use all attached SiteScope monitors

## 3 Specify the SiteScope Monitor Used to Execute Siebel Diagnostics Tools

Specify the default SiteScope agent/profile used to execute Siebel diagnostics tools when using the context menus options listed in the **Go to Siebel Diagnostics** context menu. For details, see “Go to Siebel Diagnostics” in “Menu Options” in *Using Dashboard*.

To specify the default SiteScope monitors, select **Admin > Platform > Setup and Maintenance > Infrastructure Settings**, choose **Applications**, select **Siebel**, and locate the **Default SiteScope for Diagnostic drilldown from the Dashboard** entry in the Siebel - General Settings table. Enter the name of the default SiteScope that is being used from Dashboard to execute diagnostic tools.

## 4 Change the Default Timeout for the Execution of a SiteScope Monitor

If the **Siebel.ejb.log**, located on the Center server, indicates that an execution of a SiteScope monitor timed-out, change the default timeout for the execution of this monitor.

To change the default timeout for the execution of a SiteScope Monitor, select **Admin > Platform > Setup and Maintenance > Infrastructure Settings**, choose **Foundations**, select **Verticals**, and locate the **SiteScope monitor timeout in seconds** entry in the Vertical - SiteScope Remote Control Settings table. Modify the parameter's value. The parameter indicates the default timeout for the execution of a SiteScope monitor.

## 5 Increase the Default Timeout for Either a SARM Task or a SARM Analyzer Execution

If the <SiteScope root directory>\tools\sarmDiagnostics\logSiteScope\sarmanalyzer.log indicates that a SARM task or SARMAnalyzer execution has been timed-out, increase the default timeout for either a SARM task or a SARM analyzer execution.

To increase the default timeout for either a SARM task or a SARM analyzer execution, select **Admin > Platform > Setup and Maintenance > Infrastructure Settings**, choose **Applications**, select **Siebel**, and locate the Siebel - Siebel SARM Breakdown table. Modify the following parameters:

- ▶ **SARM task timeout in seconds.** Indicates the default timeout for the execution of a SARM task (analyzing Web Server file, analyzing Application Server files, and so on).
- ▶ **SarmAnalyzer command timeout in seconds.** Indicates the default timeout for the execution of sarmanalyzer.exe (used to generate CSV or XML files).

## Context Menu Options

In the Siebel-related views, right click CIs to display a list of the context menu options available in the Siebel Enterprises view. For details, see “Customize Dashboard Display and Refresh Rate” in *Using Dashboard*.

The context menu options available from the Siebel-specific CITs are listed in “Go to Siebel Diagnostics” in *Using Dashboard*. An additional context menu option is **Cross-Performance Report** accessed by using the Siebel Cross-Performance option. For details, see “Go to Report” in *Using Dashboard*.



Different context menu options are available depending on the type of Siebel-specific CIs you right-click:

Type of CIT	Context Menu Option
<b>Siebel Site</b>	Siebel Database Breakdown Siebel SARM
<b>Siebel Application</b>	Siebel Database Breakdown
<b>Siebel Application Server</b>	Cross-Performance Report Show Tasks in Error Show Running Tasks Show Processes
<b>Siebel Component Group</b>	Cross-Performance Report Show Tasks in Error Show Running Tasks Show Processes
<b>Siebel Component</b>	Cross-Performance Report Show Tasks in Error Show Running Tasks Show Processes
<b>Siebel Web Server Extension</b>	Cross-Performance Report
<b>Siebel Web Application</b>	Cross-Performance Report



## Default CITs in the Siebel View









In Dashboard, access the Siebel Enterprises view to view information about the Siebel IT entities, the Siebel enterprise metrics monitored by SiteScope monitors, and information about the Siebel business processes/transactions simulated by Business Process Monitor scripts.







The Siebel Enterprises view appears as follows:



The CITs are as follows:

CIT (A-Z)	Icon	Description
BPM Transaction/ Location		The BPM Transaction/Location CIs represent a BP Step/Location intersection (a specific transaction running at a specific location).
Business Process Step		The Business Process Steps (BPM transactions inside a script) CIs are emulated Siebel transactions executed on a Business Process Monitor machine. They are used to supply proactive monitoring of end user experience.
Configuration File		The Configuration File CIs represent the <b>siebel.cfg</b> configuration file that includes information from the application server installation or the <b>parameters.cfg</b> that includes the output of the list parameters for component command using <code>srvrmgr</code> .

CIT (A-Z)	Icon	Description
Contained Group		The Group CI is a logical container. This is not a Siebel-specific CI. The Siebel Enterprises view includes the following groups: Applications, Business Processes, Hosts, and Locations.
Contained Location		The Contained Location CIs are created as part of the Business Process Monitor hierarchy when working with the <b>Transactions/locations</b> option. They represent the locations from which the BP Steps monitoring Siebel are run.
Database		The Database CI represents the database that is holding the data tier. This is not a Siebel-specific CI.
Host		A Host CI represents the physical machine on which a server is installed. This is not a Siebel-specific element.
Siebel Application		The Siebel Application CI represents the Siebel complete solution for an organization's needs in a certain area. For example: marketing, call center, and so forth.
Siebel Application Server		The Siebel Application Server CI represents a server running the business logic tier that supports both back-end and interactive processes for every Siebel client.
Siebel Component		The Component CI represents a process running on the Siebel Application Server, which encapsulates some Siebel application functionality.
Siebel Component Group		The Component Group CI represents an administrative grouping of components comprising an application running on the Siebel Application Server.

CIT (A-Z)	Icon	Description
Siebel Enterprise		The Siebel Enterprise CI represents the logical grouping of Siebel Application Servers that support the same group of users accessing a common database server.
Siebel Gateway		The Siebel Gateway server is a coordinating server that routes requests to the correct component and provides enhanced scalability, load balancing, and high availability across the Siebel Enterprise.
Siebel Web Server Extension		The Siebel Web Server Extension CI represents the Siebel Web Server Extension installed on the Web server.
Siebel Web Application		The Siebel Web Application CI represents the application URL as it exists on the Siebel Web Server Extension.
SiteScope Measurement		<p>The SiteScope Measurement CI is not a Siebel-specific CI. However, in the Siebel Enterprises view, it usually represents a metric of a Siebel monitor; for example, the Siebel Application Server monitor.</p> <p><b>Note:</b> If SiteScope measurements names are too long and are truncated in Dashboard, you can change the CIT default label to be <b>RegExp(data_name, (.*[/].*[/].*[/])(.*),2)</b> instead of just <b>data_name</b>. In such a case, only the beginning of the path and the last part of the measurement's name are displayed instead of the entire measurement name (including the path). If you change the CIT default label, you must also change all references in the code and in the TQL layout from <b>display_label</b> to <b>data_name</b>.</p>
Web Server		The Web Server CI represents the Web server that forwards requests to the Siebel enterprise.

## **HP Business Availability Center for Siebel Applications User Interface**

### **This section describes:**

- Processes Report on page 238
- Processes Tool - Advanced Filter Dialog Box on page 240
- SARM - User Trace Breakdown (Run the Diagnostics Tool) Page on page 241
- SARM - User Trace Breakdown Dialog Box on page 244
- SARM - User Trace Breakdown - Analysis Report on page 246
- Siebel Database Breakdown Configuration Report on page 259
- Siebel Database Breakdown Analysis Report on page 262
- Siebel Deployment Validator Page on page 264
- Siebel Deployment Validator Test Summary Dialog Box on page 269
- Tasks Diagnostics Tool Report on page 271
- Tasks Diagnostics Tool - Advanced Filter Dialog Box on page 273



## Processes Report

**Processes Diagnostics**

Enterprise:  Server:  Component group:

[Advanced Options:](#) Using sitescope: rca3

---

 1/5

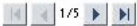
Server	Component group	Component ▾	Process Type	Process ID	CPU(%)	Memory(KB)
cannon		TxnRoute	siebproc	2996	0	2188
cannon		TxnMerge	siebproc	2980	0	2008
cannon		SynchMgr	siebmsh	2972	0	2396
cannon	System	SRProc	siebmsh	3112	0	2504
cannon	System	SRBroker	siebmsh	3052	0	1844

<b>Description</b>	<p>Enables you to view details of the Siebel Application Server processes, for each monitored Siebel Enterprise.</p> <p><b>To Access: Applications &gt; Business Availability Center for Siebel &gt; Processes</b></p> <p>You can also access this page filtered for a selected CI, when you right-click the CI in Dashboard and select the <b>Show Processes</b> option. For details, see “Go to Siebel Diagnostics” in <i>Using Dashboard</i>.</p>
<b>Important Information</b>	<ul style="list-style-type: none"> <li>➤ To sort the processes by a specific column, click the column heading.</li> <li>➤ To move between pages, use the <b>First</b>, <b>Previous</b>, <b>Next</b>, and <b>Last</b> arrows  above the table.</li> </ul>
<b>Included in Tasks</b>	“View Configuration File CI – Details” on page 227

The following elements are included (unlabeled GUI elements are shown in angle brackets>):

GUI Element (A-Z)	Description
<b>Advanced Options</b>	If necessary, click to open the Processes Diagnostics Tool - Advanced Filter page. For details, see “Processes Tool - Advanced Filter Dialog Box” on page 240.
<b>Apply</b>	Click to display the process diagnostic information. The process information you requested is retrieved from the Siebel Application Servers and displayed on the Tasks Diagnostic Tool page.
<b>Component</b>	The name of the component. If the process does not have a task attached, then the Component column is empty.
<b>Component Group</b>	Select the name of the component groups. Select <b>All component groups</b> to display the process diagnostics for all of the component groups.
<b>Component Group</b>	The name of the component group. If the process does not have a task attached, then the Component Group column is empty.
<b>CPU (%)</b>	The percentage of the host machine CPU that the relevant process instance is currently using.
<b>Enterprises</b>	Select the name of the Siebel Enterprise.
<b>Memory (KB)</b>	The amount of memory (in KB) that the relevant process instance is currently using.
<b>Process ID</b>	The process identifier.
<b>Process Type</b>	The name of the operating system process that deals with the Siebel process.
<b>Server</b>	Select the name of the application server. Select <b>All servers</b> to display the process diagnostics for all of the application servers.
<b>Server</b>	The name of the server on which the process runs.

## Processes Tool - Advanced Filter Dialog Box

<b>Description</b>	Use the advanced filter to filter the list of processes you want to display.  <b>To Access:</b> In the Processes Diagnostics Tool page, click the <b>Advanced Filter</b> linke.
--------------------	---

The following elements are included (unlabeled GUI elements are shown in angle brackets>):

GUI Element (A-Z)	Description
<b>Process Id</b>	Enter the process ID.
<b>Process Type</b>	Select the type of process. Select <b>All process types</b> to display the process diagnostics for all of the process types.
<b>Siebel Components</b>	Select the Siebel component. Select <b>All components</b> to display the process diagnostics for all of the Siebel components.
<b>Using SiteScope</b>	Select the SiteScope machine you want to use to retrieve process information.



## **SARM - User Trace Breakdown (Run the Diagnostics Tool)** Page

<p><b>Description</b></p>	<p>HP Business Availability Center for Siebel Applications SARM Diagnostics is a user trace breakdown diagnostic tool that processes the data in the User Session Trace output files produced by Siebel's SARM process. This data can be retrieved for a specific user in a specific time frame. It can also be retrieved for a specific transaction of a prerecorded script.</p> <p>You can then:</p> <ul style="list-style-type: none"> <li>▶ Invoke a specific Business Process Monitor script. For details, see “Invoke Business Process Monitor Script” on page 243.</li> <li>▶ Specify where the files can be found: <ul style="list-style-type: none"> <li>▶ Automatically collected Web and application server logs.</li> <li>▶ The SARM logs of a specific application server and Web server.</li> <li>▶ An already generated user session trace XML file for a Siebel Enterprise, a user, and a specific time frame.</li> </ul> </li> </ul> <p><b>To Access:</b> Select <b>Applications &gt; Business Availability Center for Siebel &gt; SARM - User Trace Breakdown</b> to open the SARM - User Trace Breakdown Diagnostic Tool page.</p> <p>You can also access this page filtered for the selected CI, when you right-click the CI and select the <b>Siebel SARM</b> option. For details, see “Customize Dashboard Display and Refresh Rate” in <i>Using Dashboard</i>.</p>
<p><b>Important Information</b></p>	<p>HP Business Availability Center does not support SiteScope 8.7 and earlier.</p>
<p><b>Included in Tasks</b></p>	<p>“View Configuration File CI – Details”</p>

The following elements are included (unlabeled GUI elements are shown in angle brackets>):

GUI Element (A-Z)	Description
<b>Advanced Options</b>	<p>You can run the SARM - User Trace Breakdown diagnostic tool on:</p> <ul style="list-style-type: none"> <li>▶ automatically collected Web and application server logs.</li> <li>▶ the SARM logs of a specific application server and Web server.</li> <li>▶ an already generated user session trace XML file for a site, a user, and a specific time frame. HP Business Availability Center searches all of the SARM files at the Siebel Enterprise, looks for the sessions of the specified user, fetches the appropriate files, runs the SARM analyzer, and lists all of the sessions used by the user that were active within the time frame.</li> </ul>
<b>Enterprises</b>	<p>Select the Siebel Enterprise for which you want to view SARM User Trace Breakdown data.</p>
<b>From ... To</b>	<p>Click the linked date in <b>From</b> or <b>To</b> to open a calendar and select a new date and time to change the default date and time.</p>
<b>Invoke Business Process Monitor Script area</b>	<p>You can view data about a Business Process Monitor transaction of a specific script running in the Web server(s) and application server(s) at a specific Siebel Enterprise, and in a specified period of time. HP Business Availability Center invokes the Business Process Monitor transaction, and then analyzes the relevant session. See below for details.</p>
<b>User</b>	<p>Enter the name of the user whose activity you want to trace.</p>

## Invoke Business Process Monitor Script

The following elements are included (unlabeled GUI elements are shown in angle brackets>):

GUI Element (A-Z)	Description
<b>Application</b>	Select the application.
<b>Host</b>	Select the location of the Business Process Monitor running the script.
<b>Invoke Script</b>	Click to invoke the script transaction.
<b>Script</b>	Select the script.

## Advanced Options Area

The following elements are included (unlabeled GUI elements are shown in angle brackets>):

GUI Element (A-Z)	Description
<b>Automatically collect files</b>	Select to run SARM - User Trace Breakdown diagnostics on all Web and application servers at the Siebel Enterprise. Then select the SiteScope(s) used to collect the data in the <b>Using SiteScope</b> list. This is the default.
<b>Run</b>	Click to run the diagnostics tool. The resulting information is displayed in the SARM - User Trace Breakdown - Analysis screen. For details, see “Siebel Views” on page 191.
<b>Specify a User Session Trace File</b>	Select <b>Specify a User Session Trace File</b> to work on an already generated user session trace XML file.  In the <b>User Session Trace File</b> box, enter the path to the trace file. The path is relative to the SiteScope machine.  Then select the SiteScope(s) used to collect the data in the <b>Using SiteScope</b> list.

GUI Element (A-Z)	Description
<p><b>Specify the SARM logs folders</b></p>	<p>Select <b>Specify the SARM logs folders</b> to run SARM - User Trace Breakdown diagnostics only on the specified Web and application servers for the Siebel Enterprise:</p> <ul style="list-style-type: none"> <li>▶ In the <b>Application Servers</b> box, enter the path to the SARM logs of the application server(s).</li> <li>▶ In the <b>Web Servers</b> box, enter the path to the SARM logs of the Web server(s).</li> </ul> <p>The paths are relative to the SiteScope machine.</p> <p>Then select the SiteScope(s) used to collect the data in the <b>Using SiteScope</b> list. This is the default.</p>
<p><b>Using SiteScope</b></p>	<p>Enter the SiteScope(s) used to collect the data.</p>

### **SARM - User Trace Breakdown Dialog Box**

<p><b>Description</b></p>	<p>When you run the SARM - User Trace Breakdown diagnostic tool, the SARM - User Trace Breakdown page indicates the status of each step in the procedure.</p>
<p><b>Important Information</b></p>	<p>After the process is complete, the page closes and the diagnostic results are displayed on the SARM - User Trace Breakdown - Analysis page. For details, see “Siebel Views” on page 191.</p>

The following elements are included (unlabeled GUI elements are shown in angle brackets>):

GUI Element (A-Z)	Description
<b>Analyze Results and Prepare Charts</b>	When the status indicator shows running stripes, the final results are being analyzed and charts are prepared. When the status indicator is complete, the loading has completed.
<b>Check SiteScopes connectivity</b>	When the status indicator shows running stripes, the SiteScopes connectivity is being checked. When the status indicator is complete, the operation has completed.
<b>Extract Application Servers' session data</b>	When the status indicator shows running stripes, the application server session data is being extracted. When the status indicator is complete, the extraction has completed.
<b>Load Web Servers' session data</b>	When the status indicator shows running stripes, the Web server session data is being loaded. When the status indicator is complete, the loading has completed.
<b>Processing</b>	The progress in the current step.
<b>Total Progress</b>	Indicates the total progress of the SARM - User Trace Breakdown diagnostic tool.

## SARM - User Trace Breakdown - Analysis Report

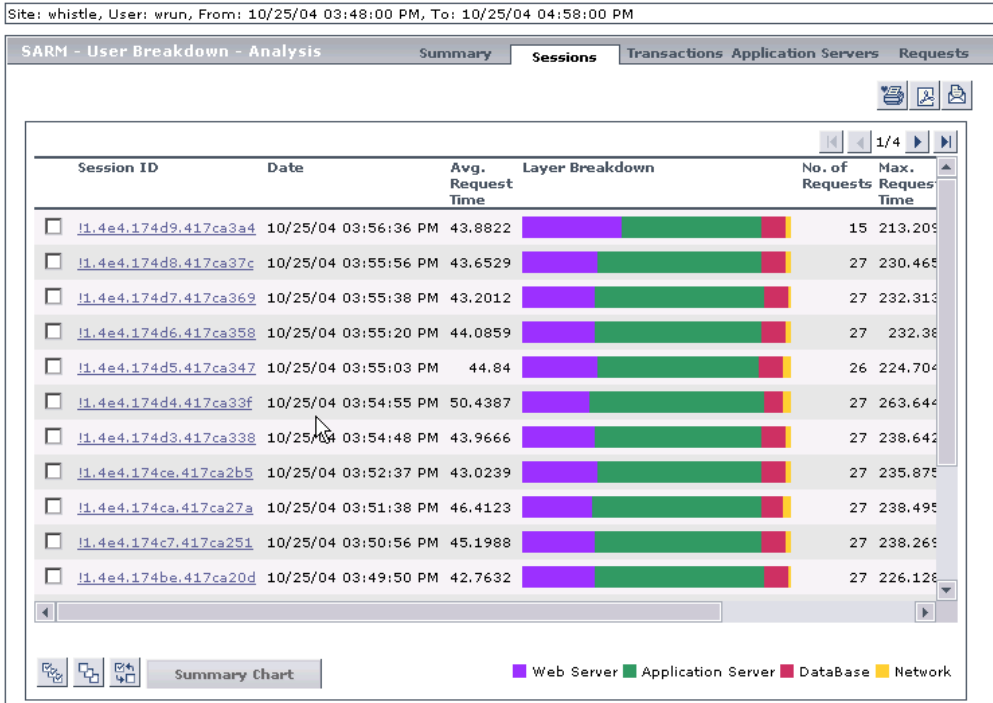

<p><b>Description</b></p>	<p>Enables you to view:</p> <ul style="list-style-type: none"> <li>▶ <b>Summary tab.</b> A chart that displays the segmentation between the average Application Server time, Web Server time, Network time, and Database time for all of the relevant requests that were found in the files. For details, see “Summary Tab” on page 248.</li> <li>▶ <b>Sessions tab.</b> The time distribution of the various sessions. For details, see “Sessions Tab” on page 249.</li> <li>▶ <b>Transaction tab.</b> For each Business Process Monitor transaction, the timestamp of the session it belongs to, the session id, the application server name, the average total time of all requests that belong to that transaction, the number of request and the maximal request time. For details, see “Transactions Tab” on page 251.</li> <li>▶ <b>Application Server tab.</b> A comparison between application servers in terms of times' distribution. For details, see “Application Servers” on page 253.</li> <li>▶ <b>Requests tab.</b> For each request, the request detailed information. For details, see “Requests Tab” on page 254.</li> </ul> <p><b>To Access:</b> Running the user trace breakdown diagnostic tool. For details, see “SARM - User Trace Breakdown (Run the Diagnostics Tool) Page” on page 241.</p>
<p><b>Included in Tasks</b></p>	<p>“View Configuration File CI – Details”</p>

### Summary Tab

<b>Description</b>	Enables you to view a chart that displays the segmentation between the average Application Server time, Web Server time, Network time, and Database time for all of the relevant requests that were found in the files.
--------------------	---

The following elements are included (unlabeled GUI elements are shown in angle brackets):

<b>GUI Element (A-Z)</b>	<b>Description</b>
<drill down>	Drilling down one of the segments in the chart provides a pie chart that displays the segmentation between the sub areas of that segment. If there is another level of specification (available in Siebel 7.7), you can then drill down to the sub area level.  You can then click segments of the Area Breakdown chart to open the corresponding Sub Area Breakdown chart (if it exists). For details, see below.
<pie chart>	The chart displays the segmentation between the average Application Server time, Web Server time, Network time, and Database time for all of the relevant requests that were found in the files.



The breakdown is as follows:

Layer Breakdown	Area Breakdown	Sub Area Breakdown
Web Server	N/A	N/A
Application Server	Application Manager	Request Receipt (sessID SeqID)
	Object Manager	Session Re-Login
	Communications Server Services	Communications Client Invoke Method
		Communications Server Invoke Method
	Build Web Page	Build View Layout
		Show Applet, Build View Data
		Build Applet
		Get View Layout
Database	Database Connector	N/A
Network	N/A	N/A

### Sessions Tab

<b>Description</b>	Enables you to view the time distribution of the various sessions.
--------------------	--

The following elements are included (unlabeled GUI elements are shown in angle brackets>):

GUI Element (A-Z)	Description
<b>Application Server</b>	The name of the application server on which the session is running.
<b>Avg. Request Time (sec)</b>	The average time the request spent in the session.
<b>Date</b>	The timestamp of the session.

GUI Element (A-Z)	Description
<b>Layer Breakdown</b>	The breakdown of the layer into its areas relative to the time spent by the session in each area: Web Server, Application Server, Database, and Network. Tooltips display the average time the session spent in each area.
<b>Max Request Time (sec)</b>	The maximum time spent by a request in the session. Scroll to the right to see the rest of the information.
<b>No. of Requests</b>	The number of requests that ran in the session.
<b>Session Id</b>	The ID of the session. You can drill the session ID to display information about the session requests. For details, see “Requests Tab” on page 254.
<b>Summary</b>	You can select one or more sessions and click <b>Summary</b> to display a summary chart for the sessions you selected. For details, see “Summary Tab” on page 248.
<b>Task ID</b>	The ID of the task the request belongs to.
<b>Web Server</b>	The name of the Web server on which the session is running.

## Transactions Tab

<b>Description</b>	Enables you to view, for each Business Process Monitor transaction, the timestamp of the session it belongs to, the session id, the application server name, the average total time of all requests that belong to that transaction, the number of request and the maximal request time.
--------------------	--

The following elements are included (unlabeled GUI elements are shown in angle brackets):

<b>GUI Element (A-Z)</b>	<b>Description</b>
<b>&lt;drill down a transaction&gt;</b>	Displays all of the requests that belong to that transaction. For details, see “Requests Tab” on page 254.
<b>&lt;tooltip&gt;</b>	Click any part of the chart to get the tooltip that indicates the time the transaction spent in the layer, area, or sub area.
<b>Application Server</b>	The name of the application server on which the transaction ran.

GUI Element (A-Z)	Description
<b>BPM Time</b>	<p>This column displays the time the invoked transaction ran in Business Process Monitor (only when the transaction is invoked using Invoke Business Process Monitor Script). This value is larger than the value in the <b>Total Time</b> column as it includes client time, network time, and so on.</p> <p><b>Note:</b> The <b>BPM Time</b> is displayed only when the SARM User Session Trace breakdown diagnostics has been run after invoking a BPM script monitoring the Siebel Application. Some additional tuning of Siebel Application\Web Server environment variables is required. This is due to the fact that the flush ratio of SARM files is approximately five times slower in the Web Server than in the Application Server, and therefore running SARM with the default value of <b>SARM_MaxFileSize</b> variable might not be enough for the SARM User Trace Breakdown diagnostic tool to return data. For details, see “Troubleshooting SARM-Related Issues” on page 278.</p>
<b>Date</b>	The date when the transaction ran.
<b>Layer Breakdown</b>	The breakdown of the layer into its areas relative to the time spend by the transaction in each area: Web Server, Application Server, Database, and Network. Tooltips display the average time the transaction spent in each area.
<b>Max. Request Time</b>	The maximum time spent by any of the requests in the transaction.
<b>No. of Requests</b>	The number of transaction requests that ran in this application server.
<b>Session ID</b>	The ID of the session.
<b>Task ID</b>	The ID of the task the transaction belongs to.
<b>Total Time</b>	The total time the transaction ran in Siebel.

GUI Element (A-Z)	Description
<b>Transaction Name</b>	The name of the transaction.
<b>Web Server</b>	The name of the Web server on which the transaction ran.

## Application Servers

<b>Description</b>	Enables you to view a comparison between application servers in terms of times' distribution.
--------------------	---

The following elements are included (unlabeled GUI elements are shown in angle brackets):

GUI Element (A-Z)	Description
<b>&lt;drill down an application server&gt;</b>	Displays all of the requests that were executed on that application server. For details, see “Requests Tab” on page 254.
<b>Application Server.</b>	The name of the application server. You can drill the session ID to display information about the application server. For details, see “Requests Tab” on page 254.
<b>Avg. Request Time</b>	The average time spent by a request executing in this application server.
<b>Layer Breakdown</b>	The time consumption breakdown by layers into its areas relative to the time spent by the request in each area: Web Server, Application Server, Database, and Network. Tooltips display the average time the request spent in each area.
<b>Max. Request Time</b>	The maximum time a request spent in this application server.

GUI Element (A-Z)	Description
<b>No. of Requests</b>	The number of requests that ran in this application server.
<b>Summary</b>	Select one or more application servers and click <b>Summary</b> to display a summary chart for the application servers you selected. For more details on the summary chart, see “Summary Tab” on page 248.

### Requests Tab

<b>Description</b>	Enables you to view, for each request, the request detailed information.
--------------------	--

The following elements are included (unlabeled GUI elements are shown in angle brackets>):

GUI Element (A-Z)	Description
<b>Application Server</b>	The name of the application server on which the task ran.
<b>BPM Time</b>	<p>Displays the time the invoked request ran in Business Process Monitor (only when the request is invoked using Invoke Business Process Monitor Script). This value is larger than the value in the <b>Total Time</b> column as it includes client time, network time, and so on.</p> <p><b>Note:</b> The <b>BPM Time</b> is displayed only when the SARM User Session Trace breakdown diagnostics has been run after invoking a BPM script monitoring the Siebel Application. Some additional tuning of Siebel Application\Web Server environment variables is required. This is due to the fact that the flush ratio of SARM files is approximately five times slower in the Web Server than in the Application Server, and therefore running SARM with the default value of <b>SARM_MaxFileSize</b> variable might not be enough for the SARM User Trace Breakdown diagnostic tool to return data. For details, see “Troubleshooting SARM-Related Issues” on page 278.</p>

GUI Element (A-Z)	Description
<b>Date</b>	The date when the request ran.
<b>Layer Breakdown</b>	The time consumption breakdown by layers into its areas relative to the time the request spent in each area: Web Server, Application Server, Database, and Network. Tooltips display the average time the request spent in each area.
<b>Request ID</b>	The ID of the request. You can drill the request ID to display information about the area where the request ran. For details, see “Area Details Area” on page 256.
<b>Session ID</b>	The ID of the session on which the request ran. Scroll to the right to see the rest of the information.
<b>Summary</b>	Select one or more application servers and click <b>Summary</b> to display a summary chart for the application servers you selected. For more details on the summary chart, see “Summary Tab” on page 248.
<b>Task ID</b>	The ID of the task the request belongs to.
<b>Total Time</b>	The total time spent to execute a request.
<b>Transaction Name</b>	The name of the transaction the request belongs to.
<b>Web Server</b>	The name of the Web server on which the task ran.

### Area Details Area

The following elements are included (unlabeled GUI elements are shown in angle brackets>):

GUI Element (A-Z)	Description
<b>Area Name</b>	The name of the area where the request ran. You can drill the area name to display information about its sub areas. For details, see “Sub Area Details Area” on page 257.
<b>Avg. Execution Time</b>	The average time spent by the request executing in the area.
<b>Exclusive Memory Max Allocated Sub Area</b>	The amount of memory used by requests that entered only this area.
<b>Max Execution Time</b>	The maximum time spent by the request executing in the area.
<b>Max Response Time SARM node App String 1</b>	The name of the method invoked or workflow process involved.
<b>Max Response Time SARM node App String 2</b>	The name of the method invoked or workflow process involved.
<b>No. of Sub Areas</b>	The number of sub areas in the area.
<b>Non-Recursive Invocations</b>	The number of times requests were invoked (non-recursive invocation) in the area.
<b>Recursive Invocations</b>	The number of times requests were invoked by other requests (recursive invocation) in the area.
<b>Summary</b>	Select one or more application servers and click <b>Summary</b> to display a summary chart for the application servers you selected. For more details on the summary chart, see “Summary Tab” on page 248.
<b>Total Execution Time</b>	The total time spent by the request executing in the area.



### Sub Area Details Area

The following elements are included (unlabeled GUI elements are shown in angle brackets>):

GUI Element (A-Z)	Description
<b>Area Name</b>	The name of the area where the sub area is located.
<b>Avg. Execution Time</b>	The average time spent by the request executing in the sub area.
<b>Exclusive Memory Max Allocated Instance</b>	The amount of memory used by requests that entered only this sub area.
<b>Max Execution Time</b>	The maximum time spent by the request executing in the sub area.
<b>Max Response Time SARM node App String 1</b>	The name of the method invoked or workflow process involved.
<b>Max Response Time SARM node App String 2</b>	The name of the method invoked or workflow process involved.
<b>No. of Instances</b>	The number of instances of the request.
<b>Non-Recursive Invocations</b>	The number of times requests were invoked (non-recursive invocation) in the sub area. Scroll to the right to see the rest of the information.
<b>Recursive Invocations</b>	The number of times requests were invoked by other requests (recursive invocation) in the sub area.
<b>Sub Area Name</b>	The name of the sub area where the request ran. You can drill the sub area name to display information about the session requests. For details, see “Instance Details Area” on page 258.

GUI Element (A-Z)	Description
<b>Summary</b>	Select one or more application servers and click <b>Summary</b> to display a summary chart for the application servers you selected. For more details on the summary chart, see “Summary Tab” on page 248.
<b>Total Execution Time</b>	The total time spent by the request executing in the sub area.

### Instance Details Area

The following elements are included (unlabeled GUI elements are shown in angle brackets>):

GUI Element (A-Z)	Description
<b>Area Name</b>	The name of the area where the request ran.
<b>Avg. Execution Time</b>	The average time spent by the request executing in the instance.
<b>Instance Name</b>	The name of the instance where the request ran.
<b>Max Execution Time</b>	The maximum time spent by the request executing in the instance.
<b>Max Response Time SARM node App String 1</b>	The name of the method invoked or workflow process involved.
<b>Max Response Time SARM node App String 2</b>	The name of the method invoked or workflow process involved.
<b>Non-Recursive Invocations</b>	The number of times requests were invoked (non-recursive invocation) in the instance.=Scroll to the right to see the rest of the information.
<b>Recursive Invocations</b>	The number of times requests were invoked by other requests (recursive invocation) in the instance.
<b>Sub Area Name</b>	The name of the sub area where the request ran.

GUI Element (A-Z)	Description
<b>Summary</b>	Select one or more application servers and click <b>Summary</b> to display a summary chart for the application servers you selected. For more details on the summary chart, see “Summary Tab” on page 248.
<b>Total Execution Time</b>	The total time spent by the request executing in the instance.

## Siebel Database Breakdown Configuration Report

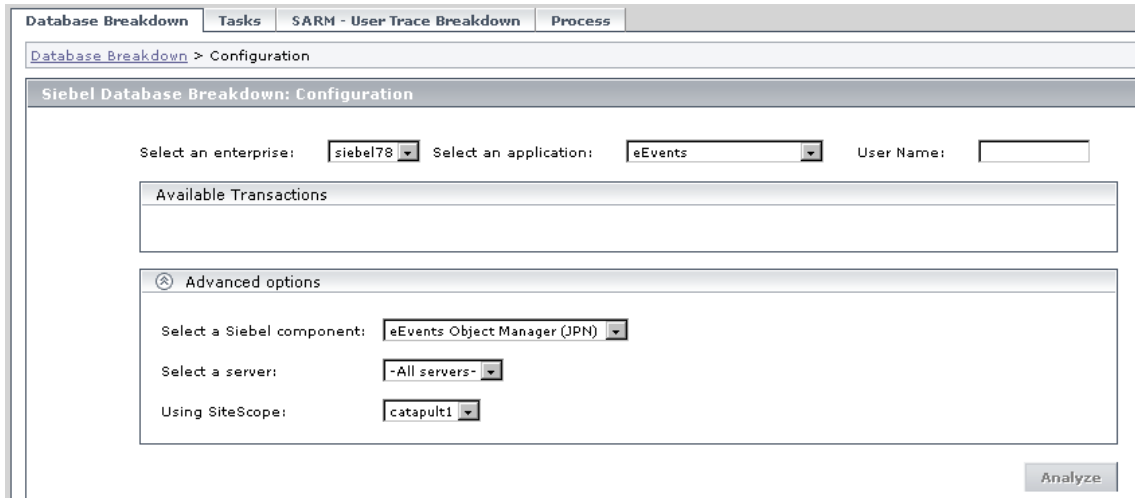

The screenshot shows the Siebel Database Breakdown Configuration Report interface. At the top, there are tabs for 'Database Breakdown', 'Tasks', 'SARM - User Trace Breakdown', and 'Process'. Below the tabs, the breadcrumb path is 'Database Breakdown > Configuration'. The main title is 'Siebel Database Breakdown: Configuration'. The form includes several fields: 'Select an enterprise:' with a dropdown menu showing 'siebel78', 'Select an application:' with a dropdown menu showing 'eEvents', and 'User Name:' with an empty text box. Below these is a section for 'Available Transactions' which is currently empty. Underneath is an 'Advanced options' section with a collapse icon. It contains three fields: 'Select a Siebel component:' with a dropdown menu showing 'eEvents Object Manager (JPN)', 'Select a server:' with a dropdown menu showing '-All servers-', and 'Using SiteScope:' with a dropdown menu showing 'catapult1'. At the bottom right of the form is an 'Analyze' button.

<b>Description</b>	<p>Enables you to run the Database Breakdown tool.</p> <p><b>To Access:</b> Select <b>Applications &gt; Business Availability Center for Siebel &gt; Database Breakdown</b> to open the Siebel Database Breakdown Configuration page.</p> <p>You can also access this page filtered for the selected CI, when you right-click the CI and select the <b>Siebel Database Breakdown</b> option. For details, see “Customize Dashboard Display and Refresh Rate” in <i>Using Dashboard</i>.</p>
<b>Included in Tasks</b>	“View Configuration File CI – Details” on page 227

### Selection Area

The following elements are included (unlabeled GUI elements are shown in angle brackets>):

GUI Element (A-Z)	Description
<b>Select an application</b>	In the list, select the Siebel application for which you want to analyze data.
<b>Select an enterprise</b>	In the list, select the Siebel Enterprise.
<b>User Name</b>	The value in the <b>User Name</b> box appears automatically when you select the application. The appropriate user name has been entered manually by your administrator after discovery has taken place and the monitoring script was recorded, but you can override it. For details, see “Deploy the SiteScope Siebel Monitors” on page 216.

### Available Transactions Area

The following elements are included (unlabeled GUI elements are shown in angle brackets>):

<b>Description</b>	Lists the transactions when you select a Siebel Enterprise and an application in the top part of the page. Click the Business Process Monitor transaction whose activity you want to analyze. (The list of transactions includes only those for which you have permissions.)
<b>Important Information</b>	For diagnostic purposes it is recommended to use a script running a dedicated user. This enables you to make sure diagnosis results refer to the Business Process Monitor transaction intended to be analyzed.

## Advanced Options Area

The following elements are included (unlabeled GUI elements are shown in angle brackets>):

GUI Element (A-Z)	Description
<b>Analyze</b>	Click to display the Siebel Tier Breakdown and Siebel Database SQL Breakdown pie charts. For details, see “Siebel Database Breakdown Analysis Report” on page 262.
<b>Select a server</b>	Select a Siebel Application Server in the list. You can also leave <b>All servers</b> selected.
<b>Select a Siebel component</b>	Select a Siebel component in the list. Only the log level for that component is brought up.
<b>Using SiteScope</b>	Select the SiteScope machine you want to use to monitor the Siebel component in the list.

## Siebel Database Breakdown Analysis Report

An example of the report:

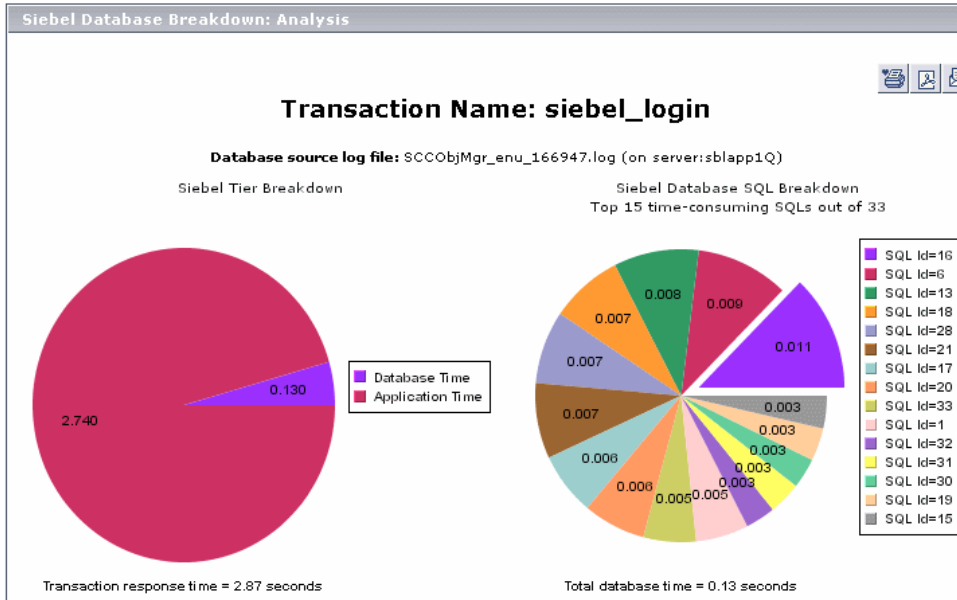

An example of the detail of one segment of the pie chart:

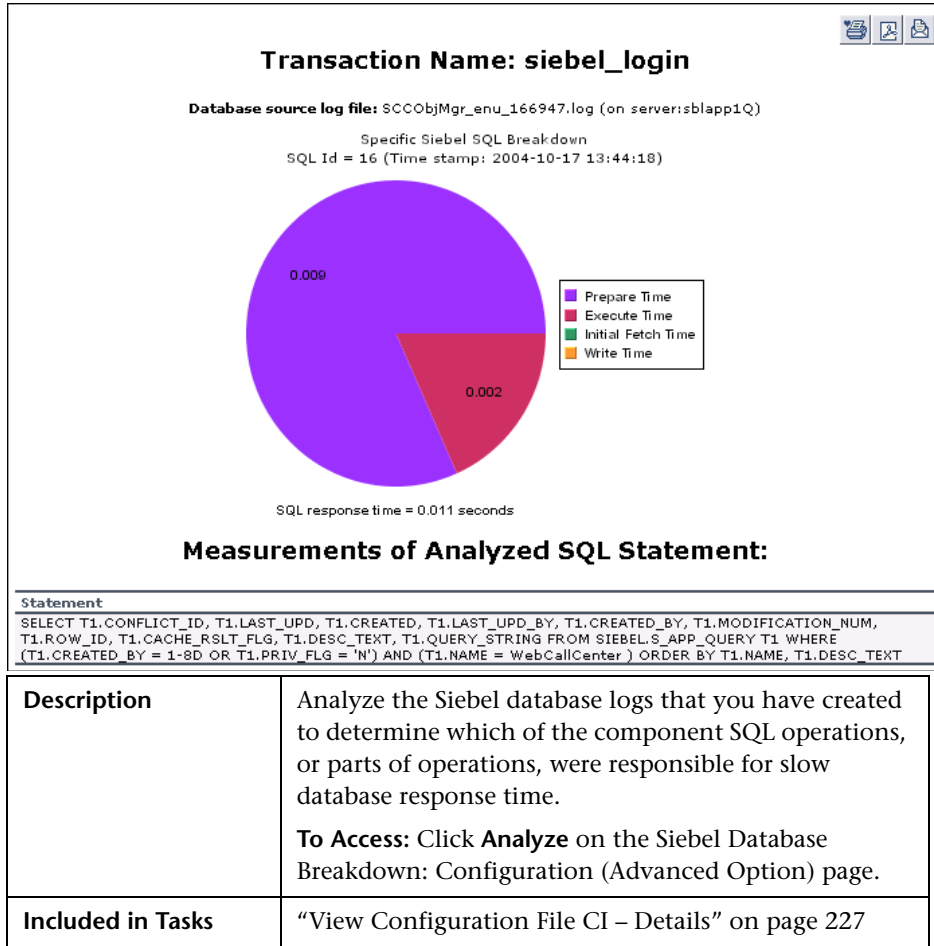

The following elements are included (unlabeled GUI elements are shown in angle brackets>):









GUI Element (A-Z)	Description
<b>Siebel Database SQL Breakdown Pie Chart</b>	Displays a breakdown of up to 15 of the most time-consuming SQLs.
<b>Siebel Tier Breakdown Pie Chart</b>	Shows the transaction's database time relative to its application time.
<b>Specific SQL Breakdown Pie Chart</b>	Click, in the Siebel Database SQL Breakdown pie chart, a section representing the required SQL, to view the database-specific time distribution of that specific SQL. For each SQL operation, you can view the various database times: preparation time, execution time, initial fetch time, total time, and write time (time stamp). This enables you to isolate the exact segment responsible for the delay in the database response time. Underneath the Specific SQL Breakdown pie chart, you can view the corresponding SQL statement.

## Siebel Deployment Validator Page

<b>Description</b>	Enables you to execute all or part of the predefined tests that detect known problems that can occur while deploying HP Business Availability Center for Siebel Applications. <b>To access:</b> Click <b>Admin &gt; Siebel Configuration</b> .
<b>Included in Tasks</b>	<ul style="list-style-type: none"> <li>➤ “Deploy HP Business Availability Center for Siebel Applications – Workflow” on page 194</li> <li>➤ “Create Customized Deployment Validator Tests” on page 228</li> </ul>
<b>Useful Links</b>	“List of Predefined Tests for Siebel Deployment Validator” on page 266

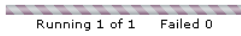

The dialog box includes the following elements (in alphabetical order):

GUI Element (A-Z)	Description
	Select a test and click the button to run the test.
	Select a test and click the button to stop the test.
	Click to display the Siebel Deployment Validator Test Summary dialog box.
	Click to display/hide the tests that ran successfully.
	Displays the test execution progress: <ul style="list-style-type: none"> <li>▶ How many tests are running</li> <li>▶ How many tests failed</li> <li>▶ How many tests ended</li> </ul>
<b>Status</b>	The status of the test. It indicates that: <ul style="list-style-type: none"> <li>▶  – The test is in waiting mode.</li> <li>▶  – The test is running.</li> <li>▶  – The test has been performed successfully.</li> <li>▶  – The test failed.</li> </ul>

GUI Element (A-Z)	Description
<p><b>Test Name</b></p>	<p>The name of the test. Predefined tests enable you to detect known problems that may occur during HP Business Availability for Siebel Applications deployment. For a list of available tests and their description, see “List of Predefined Tests for Siebel Deployment Validator” on page 266.</p> <p>A combination of parameter’s values is used to create the appropriate test. The values can be:</p> <ul style="list-style-type: none"> <li>▶ <b>@ALL@</b>. The test checks all the appropriate items represented by the parameter (for example, the Siebel Enterprises View Test checks that the Siebel Enterprises view contains all the appropriate CIs for all Siebel Enterprises sites).</li> <li>▶ <b>@ANY@</b>. The test checks at least one appropriate item represented by the parameter (for example, the SiteScope Connection Test checks that at least one SiteScope working with the Windows operating system is attached to HP Business Availability Center).</li> <li>▶ <b>@&lt;value&gt;@</b>. Some of the parameters can only be set to @ALL@ or to some specific value. For example, the BPM Script Execution Test parameters creates the following test: run at least one of the BPMScripts (BPMScripts = @ANY@) connected to the Siebel Enterprise CI (Enterprises = @siebel@) on all the locations available (Locations = @ALL@).</li> </ul>
<p><b>Description</b></p>	<p>The test description.</p>
<p><b>Category</b></p>	<p>The application related to the test: BAC, BPM, or Siebel.</p>
<p><b>Execution Time</b></p>	<p>The time and date when the test was last run.</p>

**List of Predefined Tests for Siebel Deployment Validator**

The predefined tests are listed below.

Test Name (A - Z)	Checks That:	Category	Parameters
<b>BPM Adapter Mode Test</b>	<p>The Business Process Monitor source adapter is in <b>Transaction\Location</b> mode.</p> <p>If the test fails, see “Errors That Occur when Building the Siebel Enterprises View” on page 275.</p>	BAC	None
<b>BPM Transaction Execution Test</b>	<p>The BPM Transaction can be executed.</p> <p>If the test fails, see “Errors That Occur when Building the Siebel Enterprises View” on page 275.</p> <p>If the test fails, see “Error: Could Not Run BPM Transaction” on page 294.</p> <p>You can test one or more of the following cases:</p> <ul style="list-style-type: none"> <li>▶ <b>Specific transactions.</b> The test is successful when all the specified transactions run successfully in all locations and Enterprises. This test configuration is recommended to test the availability of specific transactions.</li> <li>▶ <b>Specific locations.</b> The test is successful when at least one transaction is successful in all the specified locations and for all Enterprises. This test configuration is recommended to test the availability of specific locations.</li> <li>▶ <b>All transactions, locations, and Enterprises.</b> The test is successful when at least one transaction is successful in all locations and Enterprises. This test configuration is recommended to test the availability of all transactions, locations, and Enterprises.</li> </ul>	BPM	<ul style="list-style-type: none"> <li>▶ Locations = @ALL@</li> <li>▶ BPMTransactions = @ANY@</li> <li>▶ Enterprises = @ALL@</li> </ul>

Test Name (A - Z)	Checks That:	Category	Parameters
<b>Siebel Application Server Settings Test</b>	The <b>Log folder</b> and <b>SARM log folder</b> are defined for the Siebel Application Server, and are accessible.	BAC	<ul style="list-style-type: none"> <li>▶ Enterprises = @ALL@</li> <li>▶ AppServers = @ALL@</li> <li>▶ SiteScopes = @ALL@</li> </ul>
<b>Siebel Application Structure Test</b>	At least one Siebel Application is linked to the selected Siebel Enterprise CI that has, at least, one child BPM Transaction CI.	BAC	Enterprises = @ALL@
<b>Siebel Enterprise SARM Analyzer Setting Test</b>	The <code>sarmAnalyzer</code> path is defined and the folder is accessible from the Siebel Enterprise application.	BAC	<ul style="list-style-type: none"> <li>▶ Enterprises = @ALL@</li> <li>▶ SiteScopes = @ALL@</li> </ul>
<b>Siebel Enterprise Srvmgr Settings Test</b>	The <b>Admin user name</b> , <b>Admin password</b> and <b>srvmgr path</b> are defined for the Siebel Enterprise, and the <code>srvmgr</code> can be launched.	BAC	<ul style="list-style-type: none"> <li>▶ Enterprises = @ALL@</li> <li>▶ SiteScopes = @ALL@</li> </ul>
<b>Siebel Enterprises View Test</b>	The Siebel Enterprises view contains Siebel Enterprises CIs with child Siebel Application Server, Siebel Web Server Extension, and Siebel Gateway CIs.	BAC	Enterprises = @ALL@
<b>Siebel Package Deployment Test</b>	The <code>Siebel_monitoring.zip</code> package is deployed on HP Universal CMDB. If the test fails, see “Siebel Enterprises View Is Not Found” on page 277.	BAC	None
<b>Siebel Tasks List Command Test</b>	Checks the <b>list tasks</b> command of the Siebel server manager. If the test fails, see “Errors That Occur when Building the Siebel Enterprises View” on page 275.	Siebel	<ul style="list-style-type: none"> <li>▶ Enterprises = @ALL@</li> <li>▶ SiteScopes = @ALL@</li> </ul>





Test Name (A - Z)	Checks That:	Category	Parameters
<b>Siebel Web Server Extension Settings Test</b>	The SARM log folder is defined for the Siebel Web Server Extension and is accessible.	BAC	<ul style="list-style-type: none"> <li>▶ Enterprises = @ALL@</li> <li>▶ WSE = @ALL@</li> <li>▶ SiteScopes = @ALL@</li> </ul>
<b>SiteScope Connection Test</b>	<p>The SiteScope working with the Windows operating system is attached to HP Business Availability Center.</p> <p>If the test fails, see “Errors That Occur when Building the Siebel Enterprises View” on page 275.</p>	BAC	SiteScopes = @ANY@

## Siebel Deployment Validator Test Summary Dialog Box

<b>Description</b>	<p>Displays the results of the Siebel Deployment Validator test run.</p> <p><b>To access:</b> Select a Deployment Validator test and click the <b>Test Summary</b> button .</p>
--------------------	--

The dialog box includes the following elements (in alphabetical order):

GUI Element (A-Z)	Description
<b>Category</b>	The application related to the test: BAC, BPM, or Siebel.
<b>Description</b>	The test description.
<b>Error details</b>	The error message that explains why the test failed.
<b>Last execution date</b>	Date when the test was last run.
<b>Last time test passed</b>	Date when the test was last run successfully.

GUI Element (A-Z)	Description
<b>Status</b>	The status of the test. It indicates that: <ul style="list-style-type: none"> <li>➤  – The test is in waiting mode.</li> <li>➤  – The test is running.</li> <li>➤  – The test has been performed successfully.</li> <li>➤  – The test failed.</li> </ul>
<b>Test Name</b>	The name of the test.
<b>Test Parameters</b>	Click to open the area. The area lists the parameters used to run the test and their values and indicates where in the Infrastructure Settings you can modify the test parameters, add new tests, or delete existing tests.

## Tasks Diagnostics Tool Report

Tasks Diagnostics Tool							
Site:	whistle	Status:	-All statuses-	User:			
<b>Advanced Filter:</b> Server: All servers, Component Group: All component groups, Component: All components, Using SiteScope: rca3							<input type="button" value="Apply"/>
 1/3							
SV_NAME	CG_ALIAS	CC_ALIAS	TK_LABEL	TK_TASKID	TK_PID	TK_DISP_RUNSTATE	CC_RUNMOD
whistle	System	ServerMgr		105432	4336	Running	Interactive
whistle	CallCenter	SCCObjMgr_jpn	sadmin	105431	1988	Running	Interactive
whistle	System	ServerMgr		105430		Completed	Interactive
whistle	System	ServerMgr		105429		Completed	Interactive
whistle	System	ServerMgr		105428		Completed	Interactive

<b>Description</b>	<p>Enables you to view details of Siebel Application Server tasks.</p> <p><b>To Access:</b> Select <b>Applications &gt; Business Availability Center for Siebel &gt; Tasks</b> to open the Task Diagnostics Tool page.</p> <p>You can also access this page filtered for the selected CI, when you right-click the CI and select the <b>Show Tasks in Error</b> or <b>Show Running Tasks</b> option. For details, see “Customize Dashboard Display and Refresh Rate” in <i>Using Dashboard</i>.</p>
<b>Important Information</b>	<ul style="list-style-type: none"> <li>▶ To sort the tasks by a specific column, click the column heading.</li> <li>▶ To move between pages, use the arrows  above the table.</li> </ul>
<b>Included in Tasks</b>	“View Configuration File CI – Details” on page 227

The following elements are included (unlabeled GUI elements are shown in angle brackets>):

GUI Element (A-Z)	Description
<b>Advanced Filter</b>	If necessary, click the link to filter the list of tasks. For details, see “View Configuration File CI – Details” on page 227.
<b>Apply</b>	When you click the button, the task information you requested is retrieved from the Siebel Application Server(s) and displayed on the Tasks Diagnostic Tool page.
<b>CC_ALIAS</b>	The name of the component the task belongs to.
<b>CC_INCARN_NO</b>	The number of times the task was restarted.
<b>CC_RUNMODE</b>	The mode used to execute the task: <b>Interactive</b> or <b>Batch</b> .
<b>CG_ALIAS</b>	The name of the component group the task belongs to.
<b>Enterprise</b>	Select the Siebel site/enterprise for which you want to view task data.
<b>Status</b>	Select the specific status— <b>Running, Paused, Stopping, Completed, Exited with Error, or Killed</b> . Alternatively, you can select to view tasks of all statuses.
<b>SV_NAME</b>	The name of the server on which the task is running.
<b>TK_DISP_RUNSTATE</b>	The state of the task: <b>Running, Paused, Stopping, Completed, Exited with Error, or Killed</b> .
<b>TK_END_TIME</b>	The time when the task stopped executing.
<b>TK_IDLE</b>	For future use.
<b>TK_LABEL</b>	The name of the user who is running the tasks. Some tasks (such as the ones belonging to the system component group) do not have a user.
<b>TK_PARENT_T</b>	The task that caused this task to execute.



GUI Element (A-Z)	Description
TK_PID	The operating system process ID that deals with the task. One process can handle more than one task. This column displays data only for tasks whose TK_DISP_RUNSTATE is <b>running</b> .
TK_PING_TIM	For future use.
TK_START_TIME	The time when the task started to execute.
TK_STATUS	A description of the task—added by the task. If <b>TK_DISP_RUNSTATE</b> is <b>Exited with Error</b> , <b>TK_STATUS</b> displays the error message.
TK_TASKID	The ID of the task.
TK_TASKTYPE	The urgency of the task.
User	To focus on the tasks of a specific user, fill in the user name in the User box.

## Tasks Diagnostics Tool - Advanced Filter Dialog Box

<b>Description</b>	Use the advanced filter to filter the list of tasks you want to display.  <b>To Access:</b> In the Task Diagnostics Tool page, click the <b>Advanced Filter</b> link to open the Tasks Diagnostics Tool Advanced Filter page.
--------------------	---

The following elements are included (unlabeled GUI elements are shown in angle brackets>):

GUI Element (A-Z)	Description
<b>Component</b>	Select the specific component for which you want to view task data.
<b>Component group</b>	Select the specific component group for which you want to view task data.

GUI Element (A-Z)	Description
Server	Select the specific server whose task data you want to view.
Using SiteScope	Select the SiteScope machine you want to use to retrieve task data from the Siebel Application Server, if you do not want HP Business Availability Center for Siebel Applications to use the default SiteScope machine.

## Troubleshooting and Limitations

This section includes troubleshooting for the HP Business Availability Center for Siebel Applications.

This section includes the following topics:

- “Troubleshooting Errors in Logs” on page 274
- “Troubleshooting Siebel Enterprises View” on page 276
- “Troubleshooting Diagnostics Tools” on page 277
- “Troubleshooting SARM-Related Issues” on page 278
- “Troubleshooting Database Breakdown” on page 292
- “Troubleshooting Processes” on page 295
- “Troubleshooting Tasks” on page 296

### **Troubleshooting Errors in Logs**

Logs are available to help you debug problems with Siebel views and problems that occur when using the Siebel diagnostics tools.

This section includes the following topics:

- “Errors That Occur when Building the Siebel Enterprises View” on page 275
- “Errors That Occur when Running One of the Diagnostics Tools” on page 276

## Errors That Occur when Building the Siebel Enterprises View

When this type of error occurs, run the following tests to pinpoint the problem:

- **SiteScope Connection Test**
- **BPM Adapter Mode Test**
- **Siebel Task List Command Test**
- **BPM Transaction Execution Test**

For details about the tests, see “List of Predefined Tests for Siebel Deployment Validator” on page 266.

You can also check the **Siebel.ejb.log** file (on the Modeling server). It includes information about all the automatic links between the Business Process Monitor or SiteScope and the Siebel CIs whether these links worked correctly or not.

For details about the automatic links, see “Use a Business Process Profile to Simulate Siebel Users” on page 206.

### To debug the log:

- 1** Open the <HP Business Availability Center root directory>\conf\core\Tools\log4j\EJB\topaz.properties file
- 2** In the line that follows, change `#{loglevel}` to debug. The lines should be as follows:  
`log4j.category.com.mercury.topaz.vertical=debug, vertical.appender`  
`log4j.category.com.mercury.am.bac.vertical.rules=debug, vertical.appender`
- 3** Open the error log, located on the Modeling server at the following location:  
<HP Business Availability Center root directory>\log  
\EJBContainer\Siebel.ejb.log
- 4** Locate the `#define appender for vertical module` line.
- 5** You can now analyze the log information.

- 6 After you complete the debugging tasks, make sure to change **debug** back to **#{loglevel}** in the lines that follows **#define appender for vertical module**. The lines should be as follows:  
**log4j.category.com.mercury.topaz.vertical=#{loglevel}, vertical.appender  
log4j.category.com.mercury.am.bac.vertical.rules=#{loglevel},  
vertical.appender**

### **Errors That Occur when Running One of the Diagnostics Tools**

The **Siebel.ejb.log** file (on the Center server) includes detailed information about the operations that take place in the Siebel Diagnostics tools.

For details about the Siebel Diagnostics tools, see “HP Business Availability Center for Siebel Applications” on page 177. **To debug the log:**

- 1 Open the **<HP Business Availability Center root directory>\conf\core\Tools\log4j\EJB\topaz.properties** file
- 2 In the line that follows, change **#{loglevel}** to **debug**. The line should be as follows:  
**log4j.category.com.mercury.topaz.siebel=debug, siebel.appender**
- 3 Open the error log, located on the Center server at the following location:  
**<HP Business Availability Center root directory>\log  
\EJBContainer\Siebel.ejb.log**
- 4 Locate the **#define appender for siebel** line.
- 5 You can now analyze the log information.
- 6 After you have completed the debugging tasks, make sure to change **debug** back to **#{loglevel}** in the line that follows **#define appender for siebel**. The line should be as follows:  
**log4j.category.com.mercury.topaz.siebel=#{loglevel}, siebel.appender**

### **Troubleshooting Siebel Enterprises View**

This section describes issues related to the Siebel Enterprises View and how to solve these problems.

This section includes the following topics:

- “Siebel Enterprises View Is Not Found” on page 277
- “Session Data Is Not Available” on page 277

- “Task Data Is Not Available” on page 277

### **Siebel Enterprises View Is Not Found**

If the "Siebel Enterprises" view is not found, or if the **Siebel Package Deployment Test** fails, check that the Siebel Monitoring package appears in the Package Manager. For details, see “Package Manager” in *Model Management*.

For details about the **Siebel Package Deployment Test**, see “List of Predefined Tests for Siebel Deployment Validator” on page 266.

### **Session Data Is Not Available**

If, in the view, the Sessions KPI is empty, it might be because the **No. of Running Sessions** measurement is not monitored for an application server/component in the relevant Siebel Application Server monitor.

### **Task Data Is Not Available**

If, in the view, the **Tasks in Error** KPI is empty, it might be because the **No. of Tasks in Error** measurement is not monitored for an application server/component in the relevant Siebel Application Server monitor.

## **Troubleshooting Diagnostics Tools**

This section describes issues related to the Diagnostics tools and how to solve these problems.

### **Matching Connection Parameters to SiteScope**

When one of the diagnostics tools is activated, a temporary SiteScope monitor is created, run, and then erased. The connection parameters used are the ones that exist in the various relevant CIs (Enterprise, Application Server, and so on).

You must check that the connection parameters (user name, password, enterprise name, and gateway name) used in the CIs must conform to the parameters used in the permanent SiteScope monitors monitoring the Siebel Enterprise. (If the connection parameters do not match, then most diagnostics features do not work.) For example, the same user name and password needs to be utilized in the Siebel Enterprise configuration and in the permanent monitors defined in SiteScope.

If a problem occurs, check the SiteScope error log (in SiteScope under the logs directory) and the Siebel log and check the list of parameters used to access SiteScope and Siebel. For details about the Siebel log, see “Errors That Occur when Running One of the Diagnostics Tools” on page 276.

### **Troubleshooting SARM-Related Issues**

This section describes issues related to Siebel Application Response Measurement (SARM) and how to solve these problems.

This section includes the following topics:

- “Large Log Files” on page 279
- “Siebel Application Response Monitoring (SARM)” on page 279
- “SARM Does Not Work” on page 287
- “SARM Data Does Not Generate Properly” on page 288
- “SARM Analyzer Crashes” on page 289
- “SARM Analyzer Fails to Run” on page 289
- “SARM Configuration Issues” on page 290
- “Sitescope Server Failed to Access a Siebel SARM Folder or File” on page 290
- “Operation Completed with Several Errors” on page 291
- “Timed-out Execution of a SARM Task or SARMANalyzer Execution” on page 291
- “No Working Sitescope Server Could Be Found” on page 291

## Large Log Files

The Siebel logging mechanism for an application is sometimes configured in such way that all log data is written to a few large log files instead of creating a separate log file per task. Large log files are a problem because parsing takes a long time.

To solve the problem, two solutions are available:

- The Siebel administrator should configure the relevant parameters so that each task writes to a separate log data file.
- The Siebel administrator should provide:
  - A script to be used before running the diagnostic tools. That script should set the logging mechanism to log each task into a separate file. This is required when you want to use the Database Breakdown reports and may also be relevant when the Siebel Log Monitor is configured. Consult Siebel documentation for more detailed instructions.
  - A script to be used after running the diagnostics tool. That script should switch the log level back to its initial state.

## Siebel Application Response Monitoring (SARM)

This section describes how to improve Siebel configuration so SARM works properly and how to solve SARM-related issues in Siebel.

This section includes the following topics:

- “Enabling SARM for Siebel” on page 280
- “Calculating the SarmMaxFileSize Parameter for Siebel 7.5.3” on page 284
- “Calculating the SarmMaxFileSize Parameter for Siebel 7.7 or 7.8” on page 284
- “Tips” on page 285
- “SARM on the Windows NT Platform” on page 285
- “SARM on the UNIX Platform” on page 285

### Enabling SARM for Siebel

You can control Siebel Application Response Monitoring (SARM) using Siebel server parameters and environment variables. To enable SARM, you must enable specific SARM parameters for the Web server using environment variables and for the Siebel Server using Server Manager or the Siebel Server Manager Graphical User Interface. When a component starts up in the Siebel Enterprise, it checks the status of the following SARM parameters:

► For Siebel 7.5.3:

Name of SARM Parameter in the Web Server	Name of SARM Parameter for Application Server	Description
SIEBEL_SarmEnabled	SARMEEnabled	Indicates whether SARM is enabled or disabled for a Siebel Server Component. The default value is <b>false</b> . This parameter can be set at the Siebel Enterprise level, Siebel Application Server level, or Siebel Component level.
SIEBEL_SarmMaxMemory	SARMMaxMemory	The maximum size of the SARM memory. This parameter can be set at the Siebel Server or Siebel Server Component level.
SIEBEL_SarmMaxFileSize	SARMMaxFileSize	The maximum size of a SARM file. SARM continues to append file segments to the current file until the maximum size is reached. When the limit is reached, SARM starts a new file. The default value is <b>20,000,000</b> (~20 MB) and is specified in bytes.



## ► For Siebel 7.7 or 7.8:

Name of SARM Parameter in the Web Server	Name of SARM Parameter for Application Server	Description
SIEBEL_SARMBufferSize	SARMBufferSize	The size of the SARM buffer. The default value is 5,000,000 bytes (~5MB).
SIEBEL_SARMLevel	SARMLevel	The SARM granularity level. The default value is 0. This parameter can be set at the Siebel Server or Siebel Server Component level.
SIEBEL_SARMFileSize	SARMFileSize	The maximum size of a SARM data file. The default value is 15,000,000 bytes (~15MB).
SIEBEL_SARMMaxFiles	SARMMaxFiles	The maximum number of SARM files determines how many SARM files should be saved for a session. The recommended value is 5.
SIEBEL_SarmPeriod	SARMPeriod	The SARM period is the time when SARM outputs the stored data to the SARM log file regardless of the Buffer size. The default value is 3.

You can enable SARM for the Web server only at the Web server level, and for the application server either at the Application Server level, or at the component level (see the procedures below for more details).

**To enable SARM for Siebel at the Web server level:**

- 1** Update the values of the appropriate environment variables parameters listed in the table above.
- 2** Check whether the settings for the **SarmMaxMemory** and **SarmMaxFileSize** parameters are appropriate since these parameters determine how soon SARM flushes its data to a disk, and how large the SARM files can be. For details on the recommendations for these parameters settings, see “Calculating the SarmMaxFileSize Parameter for Siebel 7.5.3” on page 284 or “Calculating the SarmMaxFileSize Parameter for Siebel 7.7 or 7.8” on page 284.
- 3** Restart the Siebel server for the new values to take effect.

**Note:** SARM is disabled by default.

---

**To enable SARM for Siebel at the Application level from the environment variables:**

- 1** Update the values of the appropriate environment variables parameters listed in the table above.
    - a** Check whether the settings for the **SarmMaxMemory** and **SarmMaxFileSize** parameters are appropriate since these parameters determine how soon SARM flushes its data to a disk, and how large the SARM files can be. For details on the recommendations for these parameters settings, see “Calculating the SarmMaxFileSize Parameter for Siebel 7.5.3” on page 284 or “Calculating the SarmMaxFileSize Parameter for Siebel 7.7 or 7.8” on page 284.
    - b** Restart the Siebel server for the new values to take effect.
- 

**Note:**

- ▶ The Application Server Parameters can be updated from either the environment variables or from the Siebel Server user interface (follow the procedure below). If the parameters are defined both in the user interface and the environment variables, the environment variables override the user interface definitions.
  - ▶ SARM is disabled by default.
- 

**To enable SARM for Siebel at the Application Server level from the Siebel Server user interface:**

- 1** In Siebel Server Manager Graphical User Interface, select **Site Map > Server Administration > Servers > Server Parameters**.
- 2** In the Server Parameters List Applet, query for SARM.
- 3** Update the values of the appropriate parameters listed in the table above.

- 4 Check whether the settings for the **SarmMaxMemory** and **SarmMaxFileSize** parameters are appropriate since these parameters determine how soon SARM flushes its data to a disk, and how large the SARM files can be. For details on the recommendations for these parameters settings, see “Calculating the SarmMaxFileSize Parameter for Siebel 7.5.3” on page 284 or “Calculating the SarmMaxFileSize Parameter for Siebel 7.7 or 7.8” on page 284.

---

**Note:**

- ▶ The Application Server Parameters can be updated from either the environment variables (follow the procedure above) or from the Siebel Server user interface (follow the procedure below). If the parameters are defined both in the user interface and the environment variables, the environment variables override the user interface definitions.
- ▶ SARM is disabled by default.

---

**To enable SARM for Siebel at the component level:**

- 1 In Siebel Server Manager Graphical User Interface, select **Site Map > Server Administration > Servers > Component Parameters**.
- 2 In the Component Parameters List Applet, query for SARM.
- 3 Update the values of the appropriate parameters listed in the table above.

---

**Note:** SARM is disabled by default.

---

- 4 Check whether the settings for the **SarmMaxMemory** and **SarmMaxFileSize** parameters are appropriate since these parameters determine how soon SARM flushes its data to a disk, and how large the SARM files can be. For details on the recommendations for these parameters settings, see “Calculating the SarmMaxFileSize Parameter for Siebel 7.5.3” on page 284 or “Calculating the SarmMaxFileSize Parameter for Siebel 7.7 or 7.8” on page 284.

### Calculating the SarmMaxFileSize Parameter for Siebel 7.5.3

This section describes the **SarmMaxFileSize** parameter settings recommended for working with SARM in Siebel 7.5.3.

The amount of data that is written per second can be calculated in the following way:

$37\text{kb}/\text{min} * \langle \text{nbr\_of\_concurrent\_users} \rangle * \langle \text{required\_time\_frame\_saved} \rangle / \langle \text{nbr\_of\_server\_components\_instances} \rangle$

For example, if your Siebel Enterprise has 20 concurrent users, you want to save the data of the last hour for all users, and you have three instances of the Object Manager component of the application, the file size should be:  $37 * 20 * 60 / 3 = 14,800$  Kb. Therefore the **SARM Data File Size Limit** should be set to 15,000,000. The buffer size should be set to 4,000,000. The growth rates of the Web server data is 1/5 the growth of the Application Server data.

### Calculating the SarmMaxFileSize Parameter for Siebel 7.7 or 7.8

This section describes the **SarmMaxFileSize** parameter settings recommended for working with SARM in Siebel 7.7 or 7.8.

The amount of data that is written per second in Siebel 7.7 or 7.8 depends on the granularity level and can be calculated in the following way:

- **Level 1 (SIEBEL\_SarmLevel=1).** The calculation is as follows:  
 $10\text{kb}/\text{min} * \langle \text{nbr\_of\_concurrent\_users} \rangle * \langle \text{required\_time\_frame\_saved} \rangle / \langle \text{nbr\_of\_server\_components\_instances} \rangle$

For example, if your Siebel Enterprise has 20 concurrent users, you want to save the data of the last hour for all users, and you have three instances of the Object Manager component, the file size should be:  $10 * 20 * 60 / 3 = 4,000$  Kb. Therefore, the SARM Data File Size Limit should be set to: 4,000,000.

- **Level 2 (SIEBEL\_SarmLevel=2).** To store more data. The calculation is as follows:  
 $60\text{kb}/\text{min} * \langle \text{nbr\_of\_concurrent\_users} \rangle * \langle \text{required\_time\_frame\_saved} \rangle / \langle \text{nbr\_of\_server\_components\_instances} \rangle$

For example, if your Siebel Enterprise has 20 concurrent users, you want to save the data of the last hour for all users, and you have three instances of the Object Manager component, the file size should be:  $60 \times 20 \times 60 / 3 = 24,000$  Kb. Therefore, the SARM Data File Size Limit should be set to: 24,000,000.

### **Tips**

- 1** To save disk space, it is recommended to enable SARM only for Object Manager components since Siebel is only measuring the Object Managers time for the User Session trace.
- 2** If you restart the Siebel Application Server or the Web server regularly it is recommended to search, in the log folder, for old SARM files that can be deleted. Every time you restart the server a new log file, which includes the Process ID, is created. Only five log files with the same Process ID are kept at a time (the older ones are overwritten). Files with other Process IDs must be deleted manually. This procedure saves disk space and also improves the efficiency of the User Session Breakdown.

It is best if the number of SARM files saved in the SARM folders is minimal. Save only the files you want to retrieve data from. Other files can be moved to another folder (not to a sub-directory of the SARM folder) and can be used later. Too many SARM files in the SARM directories cause the SARM tool to work more slowly.

### **SARM on the Windows NT Platform**

When working with the SARM tool in Siebel 7.8, use SARM Analyzer for Siebel version 7.7.

### **SARM on the UNIX Platform**

When working with the SARM tool on a UNIX platform, check that the following requirements are met:

- **For Siebel 7.7 and 7.8**
  - When working with the SARM tool in Siebel 7.8, use SARM Analyzer for Siebel version 7.7.
  - The SARM feature is supported only if SiteScope is installed on a Windows NT platform.

- ▶ A connection must exist between SiteScope and the Siebel machine. The SiteScope user must have permission to read from the relevant directories (it means that the user has to be declared as a mounting point machine user and as a UNIX user).
- ▶ **For Siebel 7.5.3**

---

**Note:** The SARM user trace breakdown diagnostic tool is not recommended for use on Siebel 7.5.3 running on UNIX. It only works for full UNIX environments (in Siebel 7.7 you can work with mixed environments). This is a limitation from Siebel. For example, in Siebel 7.5.3, the SARMAnalyzer tool cannot work on files from different environments; therefore, if you use SARMAnalyzer for the Windows NT platform you must work only with the Windows NT environment.

---

- ▶ The SiteScope user has execution permissions for the server manager and the SARM Analyzer.
- ▶ A mount point must exist between the SiteScope machine and the Siebel machine.
- ▶ The SiteScope user must have permissions to read from the relevant directories on the Siebel machine.
- ▶ Make the following changes to the **start-monitor** and **start-service** scripts located in the <SiteScope>/classes directory: insert all the variables that are related to **LD\_LIBRARY\_PATH** from the **siebenv.sh** file (generally located in the **siebsrvr** directory), and set them to be accurate (insert all the definitions from the **siebenv.sh** file). This definition is needed to run **svrmgr** and **SARMAnalyzer** on the SiteScope machine with mount. It is recommended to copy the **svrmgr** and **SARMAnalyzer** directories to SiteScope for better performance.

## SARM Does Not Work

Ensure that all steps of the following checklist are followed.

- 1** Check that the SARM Analyzer path that you defined for the Siebel Enterprise is accessible through SiteScope, by running the **Siebel Enterprise SARM Analyzer Setting Test**. For details, see “Siebel Deployment Validator Page” on page 264.
- 2** Check that at least one Web Server, one Application Server, and one Gateway Server have been discovered during the discovery process, by running the **Siebel Enterprises View Test**. For details, see “Siebel Deployment Validator Page” on page 264.
- 3** Check that the SARM log folder defined for the Web Server is accessible through SiteScope, by running the **Siebel Web Server Extension Setting Test**. For details, see “Siebel Deployment Validator Page” on page 264.
- 4** Check that the SARM log folder defined for the Application Server is accessible through SiteScope, by running the **Siebel Application Server Setting Test**. For details, see “Siebel Deployment Validator Page” on page 264.
- 5** Check that SiteScope is running with a user on the SiteScope machine:
  - In the SiteScope machine, open **Services**.
  - Right-click the SiteScope service to open its properties.
  - Click the **Log On** tab.
  - Check that **This Account** is checked.
  - Check that the user name and password are correct.
- 6** To run the SARM Analyzer tool, check that the directory `<SiteScope_root_directory>\tools\sarmdiagnostics` exists on the SiteScope server.
- 7** Check that Siebel Server Manager properties are defined properly for the Siebel Enterprise, in IT universe (select **Admin > Universal CMDB > Modeling > IT Universe Manager**) in HP Business Availability Center (for more information, see “Matching Connection Parameters to SiteScope” on page 277).
- 8** Check that SiteScope is attached.

- 9 If you checked the entire list and SARM still does not work, check the following options:
  - “SARM Data Does Not Generate Properly” on page 288
  - “SARM Analyzer Crashes” on page 289

### **SARM Data Does Not Generate Properly**

If the **No Relevant Sessions** error message is issued when you know that you should have data, SARM might not generate properly.

#### **To identify the problem:**

- 1 Open one of the XML files located in the relevant SiteScope in the following directory: `<SiteScope installation directory>\cache\tempbyage\  
<TimeStamp>_SIEBEL_SARM\  
<web_server>_<App_server>`

---

**Note:** If there are no XML files in that directory follow the next procedure.

---

- 2 Select any of the last requests in the XML file:
  - If the request does not include a `<SiebsrvrDetails>` section with a `<Group>` node under it, then Siebel is not generating the SARM data properly.
  - If the request does include a `<SiebsrvrDetails>` section with a `<Group>` node under it, then follow the procedures below. For details, see below or “SARM Analyzer Fails to Run” on page 289.

#### **To solve the problem:**

- 1 The generated XML files are being deleted from the SiteScope and HP Business Availability Center after the generation of the SARM report. To see them you should first select the appropriate settings to save these files and not delete them. For details, see “Save the Generated XML Files After Generating the SARM Report” on page 230.
- 2 Delete all the SARM files from the Application Server and from the Web server.
- 3 If this does not help, restart the Siebel machine.



## SARM Analyzer Crashes

If the **No Relevant Sessions** error message is issued when you know that you should have data, SARM Analyzer might have crashed because the requests counter was reset to **0** in the middle of the session without any logical reason. Another indication is that it takes at least five minutes for this error to appear, because the execution of the batch files in SiteScope times out.

### To identify the problem:

SARM Analyzer has crashed if any one of the following situations occurs:

- ▶ A message (**No relevant sessions were found**) is issued, indicating that there are no sessions when you know there should be sessions.
- ▶ The timestamp of the **crash<nnn>** file in the SARM Analyzer folder corresponds to the time when you ran the User Session Trace. This indication almost always occurs.
- ▶ An error message is issued in the SiteScope machine. This indication is rare.

### To solve the problem:

Connect to the Siebel Web server, and delete (locally) the last SARM binary file from the Web server log folder.

If this does not help and the problem occurs again, restart the Siebel machine.

## SARM Analyzer Fails to Run

When you run the SARM Analyzer from a remote machine (not locally on the SiteScope machine), the SARM Analyzer fails to run.

### To identify the problem:

SARM Analyzer failed to run if any one of the following situations occurs:

- ▶ A message (**No relevant sessions were found**) is issued, indicating that there are no sessions when you know there should be sessions.
- ▶ One of the following errors was added to the SiteScope **sarmAnalyzer.log** log in **<SiteScope installation directory>**  
**\Tools\sarmDiagnostics\log\sarmAnalyzer.log** during the execution of the SARM diagnostics:

- Failed to analyze app server SARM files
- SarmAnalyzer failed
- Error running command: <command\_name>

---

**Note:** The problem occurs because of a different domain or because of permissions issues.

---

**To solve the problem:**

Check that SiteScope can communicate with the Siebel server.

**SARM Configuration Issues**

SARM configuration is not correct, if SARM is configured to store data for a long period of time (several days), or if processing takes too long.

**To solve the problem:**

Configure SARM correctly.

**Sitescope Server Failed to Access a Siebel SARM Folder or File**

After running SARM Diagnostics, the error message **A Sitescope server failed to access a Siebel SARM folder or file. Make sure all SiteScope servers have the proper permissions.** is displayed.

This usually happens because the user name used to log to the SiteScope Service does not have the appropriate permissions to access the SARM folder on the Web or application server.

**To solve the problem:**

- 1** Go through steps 3 to 8 of the SARM Does Not Work procedure above. For details, see “SARM Does Not Work” on page 287.
- 2** Log in to one of the SiteScope machines with the SiteScope username and password, and try to access the SARM folders defined in HP Business Availability Center.

## Operation Completed with Several Errors

After running SARM Diagnostics, the error message **The operation completed with several errors. Please check the logs for more information.** is displayed.

This error can be caused by a number of reasons, including unexpected SARManalyzer output, network issues, or Server manager errors.

To check the errors that occurred, go through the following log files and search for error messages logged around the time you invoked User Session Breakdown:

- ▶ On the HP Business Availability Center Gateway server:  
<HP Business Availability Center root directory>  
/log/EJBContainer/siebel.ejb.log
- ▶ On the SiteScope machine:  
<SiteScope root directory>/tools/sarmDiagnostics/log/sarmAnalyzer.log

## Timed-out Execution of a SARM Task or SARManalyzer Execution

If the sarmAnalyzer.log (SiteScope) indicates that a SARM task or SARManalyzer execution has been timed-out, increase the default timeout for either a SARM task or a SARM analyzer execution. For details, see “Increase the Default Timeout for Either a SARM Task or a SARM Analyzer Execution” on page 232.

If the **Siebel.ejb.log** (on the Gateway Server) indicates that an execution of a SiteScope monitor got timed-out, change the default timeout for the execution of this monitor. For details, see “Increase the Default Timeout for Either a SARM Task or a SARM Analyzer Execution” on page 232.

## No Working Sitescope Server Could Be Found

If the message **No working SiteScope server could be found to process SARM data.** is issued when running SARM Diagnostics, proceed as explained in this section.

**To solve the problem:**

- 1** Open the **Advanced Options** section of the User Trace Breakdown page in HP Business Availability Center. For details, see “Siebel Views” on page 191.
- 2** Verify that the SiteScope servers that are selected in **Using SiteScope:** list are the servers you want to use for SARM diagnostics.
- 3** Go through steps 5- 8 (of the SARM Does Not Work section) for these servers. For details, see “SARM Does Not Work” on page 287.
- 4** If this does not help, restart the SiteScope servers.

**Troubleshooting Database Breakdown**

This section describes how to solve Database Breakdown-related issues.

This section includes the following topics:

- “Problem When Searching for a Task Using the Siebel Database Breakdown Tool” on page 293
- “Only the Total Database Time Chart and Not the 15 SQLs Chart Is Displayed” on page 293
- “Error: Cannot Raise Log Level” on page 294
- “Error: Could Not Retrieve Log File” on page 294
- “Error: Could Not Run BPM Transaction” on page 294
- “Limitation: The Siebel Log Monitor Does not Work on a UNIX Platform” on page 295
- “Error: Database Breakdown Analysis Data for the Transaction Cannot Be Displayed” on page 295

## **Problem When Searching for a Task Using the Siebel Database Breakdown Tool**

If the Siebel Enterprise uses a gateway with an additional SSL that supplies dynamic IDs for every user session, searching for the proper tasks using the Siebel Database Breakdown tool may be problematic.

### **To solve the problem:**

A possible solution is to find the correlation in the VuGen script and to update the Siebel Application's user in the Siebel Application Configuration.

To do so, select **Admin > Universal CMDB**, select the Siebel Enterprises view, select the appropriate Siebel Application CI in View Explorer, and select the Properties tab. In the Other Properties area, enter the appropriate user name in the **Emulated Transaction User Name** box, and click **OK**.

---

**Note:** It is recommended to use a script with no more than five transactions when using the Database Breakdown diagnostics.

---

## **Only the Total Database Time Chart and Not the 15 SQLs Chart Is Displayed**

When the Siebel Database SQL Breakdown pie chart displays only the total database time chart and not the 15 SQLs chart, then there were no significant SQL queries to display. The chart displays only the 15 SQL queries that were the most time consuming. If all SQLs were under 1% of the total execution time of the transaction, then this information is not displayed. For details, see "Siebel Database Breakdown Analysis Report" on page 262.

### **Error: Cannot Raise Log Level**

The error message: **Cannot raise log level** is issued in one of the following situations:

- ▶ A server manager has not been copied to the SiteScope server. For details, see “Copy the srvmgr Tool and the SARM Analyzer Tool to the SiteScope Server – Details” on page 203.
- ▶ You did not configure the correct parameters for the Siebel Enterprise CI. For details, see “Matching Connection Parameters to SiteScope” on page 277.
- ▶ There is no license for Siebel in the SiteScope. For details, see “Check the Siebel License in SiteScope” on page 197.

### **Error: Could Not Retrieve Log File**

When the error message: **Could not retrieve log file** is issued, check the log folder of the server where the Siebel application is located. Ensure that it is shared and that there is access to it from SiteScope, so the user can open the shared folder from the SiteScope and copy files from it. Check also that all the relevant Siebel servers have a remote definition on the SiteScope. For details, see “Microsoft Windows Remote Preferences” in *Using System Availability Management*.

### **Error: Could Not Run BPM Transaction**

When the error message: **Could not run BPM transaction** is issued or when the **BPM Transaction Execution Test** fails, one of the following situations may have occurred:

- ▶ The Business Process Monitor server is down.
- ▶ The connection from HP Business Availability Center to the Business Process Monitor is problematic.
- ▶ There is a problem with the Business Process Monitor script.

To solve the problem, access the Business Process Monitor and run the transaction manually to check if there is a problem with the Business Process Monitor.

For details about the **BPM Transaction Execution Test**, see “List of Predefined Tests for Siebel Deployment Validator” on page 266.

### **Limitation: The Siebel Log Monitor Does not Work on a UNIX Platform**

The SiteScope Siebel Log monitor does not work when logs are located on a UNIX platform.

### **Error: Database Breakdown Analysis Data for the Transaction Cannot Be Displayed**

The error message: **Database breakdown analysis data for the transaction cannot be displayed. This might be because the analysis filters currently set for the transaction exclude the existing data.** is displayed when the time zone and time definitions of the SiteScope server or Business Process Monitor server used for the Database Breakdown tool are not synchronized with the Siebel server time zone and time definition.

A workaround is to synchronize the time zone and time definition of the servers and if they are synchronized, to rerun the Database Breakdown tool.

## **Troubleshooting Processes**

This section describes how to solve processes-related issues.

### **Processes Tool Does Not Function Or Files Do Not Get Through SiteScope**

- Check that the SiteScope user has permission to log to the Siebel machines.
- If another user is currently running SiteScope or ran SiteScope when the SiteScope server had not been booted, restart the SiteScope machine and the SiteScope service.
- Check that all Siebel servers are defined as remote servers on the SiteScope server.

## Troubleshooting Tasks

This section describes how to solve task-related issues.

### **No. of tasks in error Counter**

The **No. of tasks in error** counter reports all the tasks that have exited with error in the last hour.

In the advanced options of the SiteScope monitor, if you configure the **Siebel Tasks Time Window** parameter to **0**, the **No. of tasks in error** counter displays all the tasks regardless of their start time.



# Part IV

---

## Business Availability Center APIs



# 4

---

## HP Business Availability Center APIs

The following APIs are included with HP Business Availability Center:

- ▶ **Generic Reporting Engine API.** Enables extraction of data from the Business Availability Center database for use with third-party or custom tools. For details, see “Working with the Generic Reporting Engine API” on page 301.
- ▶ **CMDB API.** Enables writing configuration item definitions and topological relations to the CMDB (Configuration Management Database), and querying the information with TQL and ad hoc queries. For details, see “Working with the HP Universal CMDB API” on page 325.
- ▶ **Dashboard API.** Enables retrieving information about one or more views in an HP Business Availability Center system through a URL-based query to the database. For details, see “Working with the Dashboard API” on page 395.



# 5

---

## Working with the Generic Reporting Engine API

---

**Note to HP Software-as-a-Service customers:** For details on how to use the Generic Reporting Engine API in an HP Software-as-a-Service environment, contact HP Software-as-a-Service Support.

---

This chapter explains how to manually work with the Generic Reporting Engine API to extract data from HP Business Availability Center for use with third-party or custom tools.

**This chapter includes:**

- ▶ Introducing the Generic Reporting Engine API on page 302
- ▶ Data Returned on page 303
- ▶ Querying with a Browser on page 304
- ▶ Using the Web Service on page 305
- ▶ Supported SQL Syntax on page 305
- ▶ Query Limitations on page 306
- ▶ Date-Time Values on page 307
- ▶ byTime Function on page 308
- ▶ Query Examples on page 309
- ▶ Legacy Queries on page 310

## Introducing the Generic Reporting Engine API

The recommended method for creating API-level queries to the profile database is building queries using the Custom Query Builder. The Custom Query Builder enables the building of queries using a graphical user interface, and facilitates the generation of reports, extraction of data in different formats, and generation of query URLs that can be used with third-party or custom tools. For details, see “Custom Query Builder” in *Reports*.

The Generic Reporting Engine API also enables manual creation of queries using the following methods:

- ▶ **Web browser.** The request is sent as an HTML query and the data is returned as HTML or as a CSV (Comma Separated Values) file that can be opened with Microsoft Excel or processed with a custom tool.
- ▶ **Web Service.** The return object contains the data in CSV format.

The remainder of this chapter describes how to create queries manually.

### Prerequisite Knowledge

Users of the API should be familiar with SQL syntax and HP Business Availability Center administration and applications. Users of the API via Web Service should also be familiar with the SOAP specification and an object-oriented programming language such as C++ or Java.

### Permissions

For a query to access the data using the API query syntax described below, the user and password parameters passed in the query must be those of a user with either System Viewer or Superuser permissions. (For details on setting permissions in the Permissions Manager, see “Permissions Overview” in *Platform Administration*.)

### Configuration

You can configure the API options at **Admin > Platform > Setup and Maintenance > Infrastructure Settings > Foundations > Generic Data Engine Open API**. You can set the maximum number of data rows returned, as well as disable use of the Generic Reporting Engine API.

## Getting Metadata on the Samples

When building queries, you must know the data representation of the sample. For information on commonly queried samples and descriptions of their fields, see “Data Samples” in *Reference Information*.

## Advanced Sample Retrieval

Users with special reporting needs can retrieve a list of all samples and their fields using the MBean Inspector. Access the MBean Inspector page by entering the following URL in your browser:

```
http://<server>[:port]/jmx-console/
HtmlAdaptor?action=inspectMBean&name=Topaz%3AService%3DMeta-Data+
Manager
```

The default port number is 8080. If this port is incorrect, consult your system administrator for the correct port number.

On the MBean Inspector page, click the **Invoke** button next to the operation **showMetaDataDBMapping**. The bean returns a list of fields in each sample.

## Data Returned

The same data is returned whether the request is made from a browser or with the Web Service. With a browser, the data resides in the response body, and for the Web Service, the data resides in the return object.

## Web Browser Response Body

When the query is submitted from a browser, the response CSV or HTML contains the data, or error code and message. If the number of rows to be returned exceeds the maximum, the last row of the data is **Returned X of Y rows**, where *X* is the number of rows returned and *Y* is the actual number of rows that fulfil the conditions of the query. If there is an error at the engine level, the HTTP success code is returned, but the body of the response is `<error code>`, `<error message>`.

## Web Service Return Object

The Web Service return object contains the following:

- ▶ **retval**. The data or an error message.
- ▶ **errorCode**. The error code (type int). Possible error codes are:
  - ▶ 0 - Success
  - ▶ 100 - Authorization error
  - ▶ 101 - Processing error
  - ▶ 102 - Open API has been disabled
- ▶ **origRowCount**. The actual number of rows the query should have returned (type int). If the number of rows to be returned exceeds the maximum, the **origRowCount** field is set to the actual number of rows that the query would have returned had the maximum not been exceeded.

## Querying with a Browser

When querying with a browser, the `getData` service is called with the URL:

```
http://<server>[:port]/topaz/gdeopenapi/  
GdeOpenApi?method=getData&user=<username>&password=<password>&qu  
ery=<query>
```

or with the optional result type parameter:

```
http://<server>[:port]/topaz/gdeopenapi/  
GdeOpenApi?method=getData&user=<username>&password=<password>&qu  
ery=<query>&resultType=csv
```

The port specification is only necessary for non-standard installations. Consult your system administrator for the correct port number.

The default return type is HTML. If `resultType=csv` is specified, a comma separated values file is returned.



## Using the Web Service

The API Web Service enables submitting a query consisting of a username, password, and an SQL-like select statement. The engine returns an error description if it cannot parse the statement or if there is a problem running the query. If there is no error, the results of the query are returned.

SOAP programmers can access the WSDL at:

`http://<server>[:port]/topaz/gdeopenapi/services/GdeWsOpenAPI?wsdl`

The port specification is only necessary for non-standard installations. Consult your system administrator for the correct port number.

## Supported SQL Syntax

The language supported is a subset of SQL and supports these keywords, modifiers, and operators:

- SELECT
- WHERE
- FROM
- TOP
- HAVING
- Aliasing with the AS keyword
- Logical operators OR , AND , NOT
- DISTINCT modifier
- IN operator. Inner selects can be used to return the values for the IN operator.
- BETWEEN operator
- IS NULL (IS NOT NULL is not supported)
- LIKE. The wildcard character is the asterisk (\*). Do not use the percent sign (%). The asterisk can not be used by itself (LIKE \*). It must be used with other characters.

- ▶ Comparators: =, IS, !=, <>, >, >=, <, <=
- ▶ Functions: MAX, MIN, SUM, COUNT, AVG, STDDEV, SUMOFSQR, LOG, CEIL, FLOOR, MOD, SQRT, REPLACENULL, IF, and the “byTime Function” described on page 308.
- ▶ ORDER BY and the ASC and DESC modifiers

## Query Limitations

The following limitations apply to queries submitted to the service:

- ▶ Composite expressions in the SELECT clause using parenthesis are not supported. For example, you cannot select (a+b)/c. Use of parentheses for function arguments is supported, for example, max(a+b).
- ▶ Only one monitor type can be selected in a single query.
- ▶ The asterisk (\*) is not supported as a wildcard character except in combination with the LIKE operator. It is supported as the multiplication operator.
- ▶ Inner selects and joins are not supported, with one exception: an inner select can be used to return the values for an IN clause.
- ▶ The ORDER BY clause requires a column number, for example ORDER BY 1. ORDER BY column name is not supported.
- ▶ The engine requires that queries contain a time limitation in the WHERE clause.
- ▶ The GROUP BY clause is not supported. It is unnecessary because the engine treats all fields that do not have an aggregate function as GROUP BY fields.
- ▶ When manually defining a filter that consists of strings containing white space or special characters (for example, where bb\_guid IN (a b, c)), you must enclose the white space or special character string with quotes (for example, where bb\_guid IN ('a b', c)). When you create filters on the Filter Builder page, HP Business Availability Center automatically adds the quotes. Special characters are defined as any characters other than digits, letters, and the following characters: "\_", "\$", "#".

- ▶ When defining a filter that consists of strings containing one or more single quote characters, you must add a second single quote character beside each instance. For example, change `szTransactionName = ('Login_to_O'brien')` to `szTransactionName = ('Login_to_O"brien')`.
- ▶ The columns in the returned data are labeled Column 0, Column 1, and so on. To return meaningful column labels, use the SQL AS operator. For example, `Select time_stamp as TimeStamp`. With this use of the AS operator, the column label is TimeStamp.

## Date-Time Values

Time in queries and return data is specified in seconds since January 1, 1970. You can use Microsoft Excel to understand the time values.

Time is most commonly used for time stamp fields.

To get a GMT time for use in a query, enter the date and time in a Date-formatted cell and in another cell, formatted as General, enter the formula:

$$=(<date\ cell> - 25569) * 86400$$

To correct for a local time zone, add the time zone offset times 3600 seconds to the result. For example, for Central Europe (GMT + 2):

$$=(<date\ cell> - 25569) * 86400 + (2 * 3600)$$

To view a time value from a query as a GMT date in Excel, use a Date format for the cell and enter the formula:

$$=<time\ stamp> / 86400 + 25569$$

To correct for a local time zone, subtract the time zone offset times 3600 seconds from the time stamp. For example, for the Eastern United States, standard time (GMT - 3):

$$=(<time\ stamp> - (-3 * 3600)) / 86400 + 25569$$

## byTime Function

The Generic Reporting Engine SQL supports the function **byTime**, which returns data grouped by time periods. For example, if you build a query that returns the average response time of a transaction for the past day, without the **byTime** function one value would be returned; using the **byTime** function, you could request to view the average response time of the transaction for each hour of the past day, in which case a value would be returned for each hour of the past 24 hours.

The function syntax is:

**byTime**(*<timefield >*, *<step value>*, *<number of step>*, *<offset>*)

Argument	Description
<i>timefield</i>	Usually a timestamp field
<i>step value</i>	One of: -1 - Time not set 10 - Second 20 - Minute 30 - Hour 40 - Day 50 - Week 60 - Month 70 - Quarter 80 - Year
<i>number of step</i>	The number of the units specified in <i>step value</i> to group.
<i>offset</i>	Time zone offset from GMT in hours. Positive numbers indicate time zones East of GMT. Negative numbers indicate time zones West of GMT.

For example, to return one value for each 3 days, corrected to two hours East of GMT:

**byTime**(time\_stamp, 40, 3, 2)

## Query Examples

Below are several examples of query URLs that retrieve different types of data from the database.

### Example of `ss_t` Sample

This example illustrates retrieving the average value for SiteScope samples on a given measurement and monitor.

```
http://myServer/topaz/gdeopenapi/
GdeOpenApi?method=getData&user=admin&password=admin&query=select
szMeasurementName, szMonitorName, avg(dValue) from ss_t where
u_iStatus=1 and time_stamp > 123456 and szMeasurementName =
'myMeasurementName' and szMonitorName = 'myMonitorName'
```

### Example of `trans_t` Sample

This example illustrates retrieving the average response time, grouped by minutes and offset to GMT + 3 for Springfield\_infra\_ems\_login transactions in the Springfield\_Location profile on for a given period from BPM data.

```
http://myServer/topaz/gdeopenapi/
GdeOpenApi?method=getData&user=admin&password=admin&query=select
byTime(time_stamp, 20, 1, 3.0), profile_name as ProfileName,
szTransactionName as TransactionName, AVG(dResponseTime) from trans_t
where time_stamp>=1126594800.64 and time_stamp<1126596000.64 and
profile_name='Springfield_Location' and
szTransactionName='Springfield_infra_ems_login'
```

### Example of rum\_server\_t Sample

This example illustrates retrieving a list of all rum\_server\_t samples in a given day that failed on a specified server:

```
http://myServer/topaz/gdeopenapi/  
GdeOpenApi?method=getData&user=admin&password=admin&query=select  
time_stamp, engine_name, server_name from rum_server_t where  
availability=0 and total_hits > 0 and time_stamp > 1041379200 and time_stamp  
< 1136197020 and server_name = 'myServerName'
```

### Example of rum\_page\_t Sample

This example illustrates retrieving the total server time for each URL as measured by RUM.

```
http://myServer/topaz/gdeopenapi/  
GdeOpenApi?method=getData&user=admin&password=admin&query=select  
page_url, sum(tot_server_time) from rum_page_t where time_stamp >  
1041379200 and time_stamp < 1136197020 &resultType=csv
```

## Legacy Queries

From HP Business Availability Center version 6.0, it is possible to write SQL queries directly on samples, as described in the previous sections. Customers who used the previous version of the data engine API can use the information in this section to maintain older reports.

### Structure of the Query

The query begins with the URL of the OpenAPI.jsp: `http://<server_name>/topaz/openapi/OpenAPI.jsp`

Following this is a series of query **parameter=value** pairs. The pairs are separated with an ampersand (&). You build the query using required and optional parameters.

You can also add filter parameters. For details, see “Filter Parameters” on page 321.

► **Required Parameters.** The following parameters are required:

<i>username</i>	The name of the HP Business Availability Center user running the query.
<i>password</i>	The password of the HP Business Availability Center user running the query
<i>function</i>	The type of the data to receive. One of: <b>transactions</b> – Business Process Monitor response time data <b>transactions_breakdown</b> – Business Process Monitor transaction breakdown data <b>sitescope</b> – SiteScope measurement data <b>routings</b> – WebTrace routing data <b>hops</b> – WebTrace hop data <b>transactions_error</b> – Business Process Monitor transaction error data <b>alerts</b> – Business Process Monitor alert data <b>components_breakdown</b> – Business Process Monitor component breakdown data
<i>rowDataTypes</i>	The type of aggregation to use. One of: <b>row</b> – raw data <b>hour</b> – hourly aggregated data <b>day</b> – daily aggregated data The type of aggregation cannot be a larger unit than the one specified with the optional parameter, <i>stepValueType</i> .

<p><i>profileIds</i></p>	<p>The IDs of the profiles for which to get data. Separate multiple IDs with a comma (,). For example: <code>profileIds=2,7,9</code></p> <p>To extract a profile's ID from the database:</p> <ol style="list-style-type: none"> <li>1 Open the page <code>http://&lt;servername&gt;:8080/jmx-console/index.jsp</code> in a Web browser, where <code>&lt;servername&gt;</code> represents the name of the HP Business Availability Center server.</li> <li>2 In the <b>Topaz</b> list, click the link <b>service=OAPI Services</b>.</li> <li>3 Invoke <b>com.mercury.infra.db.tools.oapiservices.ProfileMapping getProfiles()</b> to retrieve the profile ID information.</li> </ol>
<p>Time range either <i>from</i> and <i>to</i> or <i>lastPeriod</i></p>	<p>Either use <i>from</i> and <i>to</i> to specify the start and end of the period, or use <i>lastPeriod</i> to specify the period or periods ending at the time the query is called.</p> <p>The time format for <i>from</i> and <i>to</i> is: <code>dd/MM/yyyy HH:mm:ss</code></p> <p><i>lastPeriod</i> is one of:</p> <ul style="list-style-type: none"> <li><b>hour</b></li> <li><b>day</b></li> <li><b>week</b></li> <li><b>month</b></li> <li><b>quarter</b></li> <li><b>year</b></li> </ul> <p>To specify more than one unit of <i>lastPeriod</i>, use the parameter <code>numStepUnit</code> together with <i>lastPeriod</i>.</p>



► **Optional Parameters.** The following parameters are optional:

<i>numStepUnit</i>	Used with <i>&lt;italic&gt;lastPeriod</i> to indicate the number of periods included in the data. For example, get data for the last two days with: <code>lastPeriod=day&amp;numStepUnit=2</code>
<i>resultType</i>	The output file format. One of: <b>html</b> <b>xml</b> <b>csv</b> The default is <b>html</b> .
<i>stepValueType</i>	The unit of time by which the data is grouped. One of: <b>minute</b> <b>hour</b> <b>day</b> <b>week</b> <b>month</b> Use <i>stepValueType</i> in conjunction with <i>stepValue</i> to see a larger grouping than that specified with <i>rowDataTypes</i> .
<i>stepValue</i>	The number of the time units specified by <i>stepValueType</i> by which to group. For example <code>stepValueType=hour&amp;stepValue=8</code> groups the data by 8-hour periods. The default is 1.
<i>dateFormat</i>	The format for date value output (that is, the way the date and time are displayed in the report). For example, <code>MM/dd/yyyy%20HH:mm:ss</code> The "%20" indicates a space. (A space is ASCII character number 32, written 20 in hexadecimal.)
<i>timeZone</i>	A time zone specification in the form: <code>&amp;timezone=&lt;time zone value from below time zone list&gt;</code> For example: <code>&amp;timezone=Europe/London</code>

### Time Zone List

ACT	Antarctica/McMurdo	Etc/GMT0
AET	Antarctica/Palmer	Etc/Greenwich
AGT	Antarctica/Rothera	Etc/UCT
ART	Antarctica/South_Pole	Etc/UTC
AST	Antarctica/Syowa	Etc/Universal
Africa/Abidjan	Antarctica/Vostok	Etc/Zulu
Africa/Accra	Arctic/Longyearbyen	Europe/Amsterdam
Africa/Addis_Ababa	Asia/Aden	Europe/Andorra
Africa/Algiers	Asia/Almaty	Europe/Athens
Africa/Asmera	Asia/Amman	Europe/Belfast
Africa/Bamako	Asia/Anadyr	Europe/Belgrade
Africa/Bangui	Asia/Aqtau	Europe/Berlin
Africa/Banjul	Asia/Aqtobe	Europe/Bratislava
Africa/Bissau	Asia/Ashgabat	Europe/Brussels
Africa/Blantyre	Asia/Ashkhabad	Europe/Bucharest
Africa/Brazzaville	Asia/Baghdad	Europe/Budapest
Africa/Bujumbura	Asia/Bahrain	Europe/Chisinau
Africa/Cairo	Asia/Baku	Europe/Copenhagen
Africa/Casablanca	Asia/Bangkok	Europe/Dublin
Africa/Ceuta	Asia/Beirut	Europe/Gibraltar
Africa/Conakry	Asia/Bishkek	Europe/Helsinki
Africa/Dakar	Asia/Brunei	Europe/Istanbul
Africa/Dar_es_Salaam	Asia/Calcutta	Europe/Kaliningrad
Africa/Djibouti	Asia/Choibalsan	Europe/Kiev
Africa/Douala	Asia/Chongqing	Europe/Lisbon

Africa/El_Aaiun	Asia/Chungking	Europe/Ljubljana
Africa/Freetown	Asia/Colombo	Europe/London
Africa/Gaborone	Asia/Dacca	Europe/Luxembourg
Africa/Harare	Asia/Damascus	Europe/Madrid
Africa/Johannesburg	Asia/Dhaka	Europe/Malta
Africa/Kampala	Asia/Dili	Europe/Minsk
Africa/Khartoum	Asia/Dubai	Europe/Monaco
Africa/Kigali	Asia/Dushanbe	Europe/Moscow
Africa/Kinshasa	Asia/Gaza	Europe/Nicosia
Africa/Lagos	Asia/Harbin	Europe/Oslo
Africa/Libreville	Asia/Hong_Kong	Europe/Paris
Africa/Lome	Asia/Hovd	Europe/Prague
Africa/Luanda	Asia/Irkutsk	Europe/Riga
Africa/Lubumbashi	Asia/Istanbul	Europe/Rome
Africa/Lusaka	Asia/Jakarta	Europe/Samara
Africa/Malabo	Asia/Jayapura	Europe/San_Marino
Africa/Maputo	Asia/Jerusalem	Europe/Sarajevo
Africa/Maseru	Asia/Kabul	Europe/Simferopol
Africa/Mbabane	Asia/Kamchatka	Europe/Skopje
Africa/Mogadishu	Asia/Karachi	Europe/Sofia
Africa/Monrovia	Asia/Kashgar	Europe/Stockholm
Africa/Nairobi	Asia/Katmandu	Europe/Tallinn
Africa/Ndjamena	Asia/Krasnoyarsk	Europe/Tirane
Africa/Niamey	Asia/Kuala_Lumpur	Europe/Tiraspol
Africa/Nouakchott	Asia/Kuching	Europe/Uzhgorod
Africa/Ouagadougou	Asia/Kuwait	Europe/Vaduz

Africa/Porto-Novo	Asia/Macao	Europe/Vatican
Africa/Sao_Tome	Asia/Macau	Europe/Vienna
Africa/Timbuktu	Asia/Magadan	Europe/Vilnius
Africa/Tripoli	Asia/Makassar	Europe/Warsaw
Africa/Tunis	Asia/Manila	Europe/Zagreb
Africa/Windhoek	Asia/Muscat	Europe/Zaporozhye
America/Adak	Asia/Nicosia	Europe/Zurich
America/Anchorage	Asia/Novosibirsk	GB
America/Anguilla	Asia/Omsk	GB-Eire
America/Antigua	Asia/Oral	GMT
America/Araguaina	Asia/Phnom_Penh	GMT0
America/Aruba	Asia/Pontianak	Greenwich
America/Asuncion	Asia/Pyongyang	HST
America/Atka	Asia/Qatar	Hongkong
America/Barbados	Asia/Qyzylorda	IET
America/Belem	Asia/Rangoon	IST
America/Belize	Asia/Riyadh	Iceland
America/Boa_Vista	Asia/Riyadh87	Indian/Antananarivo
America/Bogota	Asia/Riyadh88	Indian/Chagos
America/Boise	Asia/Riyadh89	Indian/Christmas
America/Buenos_Aires	Asia/Saigon	Indian/Cocos
America/Cambridge_Bay	Asia/Sakhalin	Indian/Comoro
America/Cancun	Asia/Samarkand	Indian/Kerguelen
America/Caracas	Asia/Seoul	Indian/Mahe
America/Catamarca	Asia/Shanghai	Indian/Maldives
America/Cayenne	Asia/Singapore	Indian/Mauritius

America/Cayman	Asia/Taipei	Indian/Mayotte
America/Chicago	Asia/Tashkent	Indian/Reunion
America/Chihuahua	Asia/Tbilisi	Iran
America/Cordoba	Asia/Tehran	Israel
America/Costa_Rica	Asia/Tel_Aviv	JST
America/Cuiaba	Asia/Thimbu	Jamaica
America/Curacao	Asia/Thimphu	Japan
America/Danmarkshavn	Asia/Tokyo	Kwajalein
America/Dawson	Asia/Ujung_Pandang	Libya
America/Dawson_Creek	Asia/Ulaanbaatar	MET
America/Denver	Asia/Ulan_Bator	MIT
America/Detroit	Asia/Urumqi	MST
America/Dominica	Asia/Vientiane	MST7MDT
America/Edmonton	Asia/Vladivostok	Mexico/BajaNorte
America/Eirunepe	Asia/Yakutsk	Mexico/BajaSur
America/El_Salvador	Asia/Yekaterinburg	Mexico/General
America/Ensenada	Asia/Yerevan	Mideast/Riyadh87
America/Fort_Wayne	Atlantic/Azores	Mideast/Riyadh88
America/Fortaleza	Atlantic/Bermuda	Mideast/Riyadh89
America/Glace_Bay	Atlantic/Canary	NET
America/Godthab	Atlantic/Cape_Verde	NST
America/Goose_Bay	Atlantic/Faeroe	NZ
America/Grand_Turk	Atlantic/Jan_Mayen	NZ-CHAT
America/Grenada	Atlantic/Madeira	Navajo
America/Guadeloupe	Atlantic/Reykjavik	PLT
America/Guatemala	Atlantic/South_Georgia	PNT

America/Guayaquil	Atlantic/St_Helena	PRC
America/Guyana	Atlantic/Stanley	PRT
America/Halifax	Australia/ACT	PST
America/Havana	Australia/Adelaide	PST8PDT
America/Hermosillo	Australia/Brisbane	Pacific/Apiá
America/Indiana/ Indianapolis	Australia/Broken_Hill	Pacific/Auckland
America/Indiana/Knox	Australia/Canberra	Pacific/Chatham
America/Indiana/ Marengo	Australia/Darwin	Pacific/Easter
America/Indiana/Vevay	Australia/Hobart	Pacific/Efate
America/Indianapolis	Australia/LHI	Pacific/Enderbury
America/Inuvik	Australia/Lindeman	Pacific/Fakaofu
America/Iqaluit	Australia/Lord_Howe	Pacific/Fiji
America/Jamaica	Australia/Melbourne	Pacific/Funafuti
America/Jujuy	Australia/NSW	Pacific/Galapagos
America/Juneau	Australia/North	Pacific/Gambier
America/Kentucky/ Louisville	Australia/Perth	Pacific/Guadalcanal
America/Kentucky/ Monticello	Australia/Queensland	Pacific/Guam
America/Knox_IN	Australia/South	Pacific/Honolulu
America/La_Paz	Australia/Sydney	Pacific/Johnston
America/Lima	Australia/Tasmania	Pacific/Kiritimati
America/Los_Angeles	Australia/Victoria	Pacific/Kosrae
America/Louisville	Australia/West	Pacific/Kwajalein
America/Maceio	Australia/Yancowinna	Pacific/Majuro
America/Managua	BET	Pacific/Marquesas

America/Manaus	BST	Pacific/Midway
America/Martinique	Brazil/Acre	Pacific/Nauru
America/Mazatlan	Brazil/DeNoronha	Pacific/Niue
America/Mendoza	Brazil/East	Pacific/Norfolk
America/Menominee	Brazil/West	Pacific/Noumea
America/Merida	CAT	Pacific/Pago_Pago
America/Mexico_City	CET	Pacific/Palau
America/Miquelon	CNT	Pacific/Pitcairn
America/Monterrey	CST	Pacific/Ponape
America/Montevideo	CST6CDT	Pacific/Port_Moresby
America/Montreal	CTT	Pacific/Rarotonga
America/Montserrat	Canada/Atlantic	Pacific/Saipan
America/Nassau	Canada/Central	Pacific/Samoa
America/New_York	Canada/ East-Saskatchewan	Pacific/Tahiti
America/Nipigon	Canada/Eastern	Pacific/Tarawa
America/Nome	Canada/Mountain	Pacific/Tongatapu
America/Noronha	Canada/Newfoundland	Pacific/Truk
America/North_Dakota/ Center	Canada/Pacific	Pacific/Wake
America/Panama	Canada/Saskatchewan	Pacific/Wallis
America/Pangnirtung	Canada/Yukon	Pacific/Yap
America/Paramaribo	Chile/Continental	Poland
America/Phoenix	Chile/EasterIsland	Portugal
America/Port-au-Prince	Cuba	ROK
America/Port_of_Spain	EAT	SST
America/Porto_Acre	ECT	Singapore

America/Porto_Velho	EET	SystemV/AST4
America/Puerto_Rico	EST	SystemV/AST4ADT
America/Rainy_River	EST5EDT	SystemV/CST6
America/Rankin_Inlet	Egypt	SystemV/CST6CDT
America/Recife	Eire	SystemV/EST5
America/Regina	Etc/GMT	SystemV/EST5EDT
America/Rio_Branco	Etc/GMT+0	SystemV/HST10
America/Rosario	Etc/GMT+1	SystemV/MST7
America/Santiago	Etc/GMT+10	SystemV/MST7MDT
America/Santo_Domingo	Etc/GMT+11	SystemV/PST8
America/Sao_Paulo	Etc/GMT+12	SystemV/PST8PDT
America/Scoresbysund	Etc/GMT+2	SystemV/YST9
America/Shiprock	Etc/GMT+3	SystemV/YST9YDT
America/St_Johns	Etc/GMT+4	Turkey
America/St_Kitts	Etc/GMT+5	UCT
America/St_Lucia	Etc/GMT+6	US/Alaska
America/St_Thomas	Etc/GMT+7	US/Aleutian
America/St_Vincent	Etc/GMT+8	US/Arizona
America/Swift_Current	Etc/GMT+9	US/Central
America/Tegucigalpa	Etc/GMT-0	US/East-Indiana
America/Thule	Etc/GMT-1	US/Eastern
America/Thunder_Bay	Etc/GMT-10	US/Hawaii
America/Tijuana	Etc/GMT-11	US/Indiana-Starke
America/Tortola	Etc/GMT-12	US/Michigan
America/Vancouver	Etc/GMT-13	US/Mountain
America/Virgin	Etc/GMT-14	US/Pacific



America/Whitehorse	Etc/GMT-2	US/Pacific-New
America/Winnipeg	Etc/GMT-3	US/Samoa
America/Yakutat	Etc/GMT-4	UTC
America/Yellowknife	Etc/GMT-5	Universal
Antarctica/Casey	Etc/GMT-6	VST
Antarctica/Davis	Etc/GMT-7	W-SU
Antarctica/ DumontDURville	Etc/GMT-8	WET
Antarctica/Mawson	Etc/GMT-9	Zulu

### Filter Parameters

There can be one **filters** clause in the query. It is not required. If there is more than one filter in the clause, the filters are separated by a semicolon (;).

A filter consists of a report column name, a filter type, the number of patterns in the list, and a list of patterns. Each element in a filter is separated by a semicolon (;).

For example:

```
filters=MonitorTitle;in;2;9,12;Measurement;in;1;18
```

means:

```
select where (MonitorTitle equals 9 or 12) and (Measurement equals 18)
```

The following filter parameters are available:

General Filter Types	<p>These types can be used with numerical or text columns.</p> <p><b>in</b> – Data is included in the report if it equals one of the items in the list of patterns.</p> <p><b>not_in</b> – Data is included in the report if it does not equal any item in the list of patterns.</p>
Text Filter Types	<p>This type can be used with text columns.</p> <p><b>like</b> – Data is included in the report if it matches the pattern. When <b>like</b> is used, the number of patterns in the list must be one (1).</p> <p>The wildcard, asterisk (*), can be used with <b>like</b>.</p> <p>For example: filters=Host Name;like;1;ServerNum*</p>
Numeric Filter Types	<p>These types can be used with numerical columns.</p> <p><b>bigger</b></p> <p><b>smaller</b></p> <p><b>equals</b></p>

## Query Examples

Example 1:

```
http://<server_name>/topaz/openapi/OpenAPI.jsp?
username=fitzwilliam&password=darcy&function=transactions&profileIds=33&
lastPeriod=hour&rowDataTypes=raw&dateFormat=MM/dd/yyyy HH:mm:ss
```

Example 2:

```
http://<server_name>/topaz/openapi/OpenAPI.jsp?
username=fitzwilliam&password=darcy&function=transactions&profileIds=33&
from=10/12/2002 14:00:00&to=10/12/2002 15:00:00& rowDataTypes=raw&
dateFormat=MM/dd/yyyy%20HH:mm:ss
```

Example 3:

```
http://<server_name>/topaz/openapi/  
OpenAPI.jsp?username=fitzwilliam&password=darcy&function=sitescope&profil  
elds=35&lastPeriod=day&numStepUnit=2&&rowDataTypes=hour&dateFormat=M  
M/dd/  
yyyy%20HH:mm:ss&filters=MonitorTitle;in;1;9;Measurement;in;1;18&stepValue  
Type=hour&stepValue=6
```



# 6

---

## Working with the HP Universal CMDB API

---

---

Note to HP Software-as-a-Service customers: For details on how to use the UCMDB API in an HP Software-as-a-Service environment, contact HP Software-as-a-Service Support.

---

This chapter explains how third-party or custom tools can use the HP Universal CMDB API to extract data and calculations and to write data to the UCMDB (Universal Configuration Management Database).

Use this chapter in conjunction with the UCMDB schema documentation, available in the on-line documentation library.

### **This chapter includes:**

#### **Concepts**

- Conventions on page 326
- Using the HP Universal CMDB API on page 327
- HP UCMDB API Reference on page 328

#### **Tasks**

- Call the Web Service on page 329
- Create Queries to Return Unambiguous TopologyMap Elements on page 329
- Query the HP UCMDB Module on page 333
- Update the HP UCMDB Module on page 350
- Query the HP UCMDB Module Class Model on page 355

- ▶ Query for Impact Analysis on page 357

#### Reference

- ▶ Use Cases on page 360
- ▶ Examples on page 361
- ▶ UCMDB General Parameters on page 388
- ▶ UCMDB Output Parameters on page 392

## Conventions

This chapter uses the following conventions:

- ▶ This style, **Element**, indicates that an item is an entity in the database or an element defined in the schema, including structures passed to or returned by methods. Plain text indicates that the item is being discussed in a general context. For example:

A third-party application collects information about CIs and relations in its domain, and uses the appropriate API to pass the information to the UCMDB. Using this information, the UCMDB creates CIs and Relations and creates a map of the client IDs and the UCMDB IDs.

In the first sentence, CI and relation are in plain text because they are not UCMDB elements. In the second sentence, the UCMDB has created entities according to the structure specified by the schema. Therefore, they are now CI and Relation.

- ▶ UCMDB elements and method arguments are spelled in the case in which they are specified in the schema. This usually means that a class name or generic reference to an instance of the class is capitalized. An element or argument to a method is not capitalized. For example:

A relation is an element of type Relation passed to a method.

## Using the HP Universal CMDB API

The HP Universal CMDB API is a Web Service API used to integrate applications with the Universal CMDB (UCMDB). The API provides methods to:

- add, remove, and update configuration items and relations in the CMDB
- retrieve information about the class model
- retrieve impact analyses
- retrieve information about configuration items and relationships

Methods for retrieving information about configuration items and relationships generally use the Topology Query Language (TQL). For details, see “Topology Query Language” in *Model Management*.

Users of the HP Universal CMDB API should be familiar with:

- The SOAP specification
- An object-oriented programming language such as C++, C# or Java
- HP Universal CMDB

This section includes the following topics:

- “Uses of the API” on page 327
- “Permissions” on page 328

### **Uses of the API**

The API is used to fulfill a number of business requirements. For example:

- A third-party system can query the Class Model for information about the available configuration item (CI) classes. These classes are called Configuration Item Types (CITs).
- A third-party asset management tool can update the UCMDB with information available only to that tool, thereby unifying its data with data collected by HP applications.
- A number of third-party systems can populate the UCMDB to create a central UCMDB that can track changes and perform impact analysis.

- ▶ A third-party system can create entities and relations according to its business logic, and then write the data to the UCMDB to take advantage of the UCMDB query capabilities.
- ▶ Other systems, such as the Change Control Management (CCM) system, can use the Impact Analysis methods for change analysis.

## Permissions

The administrator provides login credentials for connecting with the API. The required credentials depend on whether you are using HP Universal CMDB as a standalone application or from within HP Business Availability Center:

- ▶ **HP Universal CMDB standalone.** Log in using the credentials of a DDM user who has been granted permissions on the discovery resources.
- ▶ **HP Universal CMDB embedded in HP Business Availability Center.** Log in using the credentials of a Business Availability Center user. The user must have been granted the relevant permissions on the HP Universal CMDB resource in Business Availability Center.

## HP UCMDB API Reference

For full documentation on the available APIs, refer to the HP UCMDB API Reference. These files are located in the following folder:

```
\\<HP Business Availability Center root  
directory>\AppServer\webapps\site.war\amdocs\eng\doc_lib\Solutions_a  
nd_Integrations\CMDB_Schema\webframe.html
```



## Call the Web Service

The HP Universal CMDB Web Service enables calling server-side methods using standard SOAP programming techniques. If the statement cannot be parsed or if there is a problem invoking the method, the API methods throw a SoapFault exception. When a SoapFault exception is thrown, the UCMDDB populates one or more of the error message, error code, and exception message fields. If there is no error, the results of the invocation are returned.

SOAP programmers can access the WSDL at:

[http://<server>\[:port\]/axis2/services/UcmdbService?wsdl](http://<server>[:port]/axis2/services/UcmdbService?wsdl)

The port specification is only necessary for non-standard installations. Consult your system administrator for the correct port number.

The URL for calling the service is:

[http://<server>\[:port\]/axis2/services/UcmdbService](http://<server>[:port]/axis2/services/UcmdbService)

For examples of connecting to the UCMDDB, see “Use Cases” on page 360.

## Create Queries to Return Unambiguous TopologyMap Elements

Query methods that return the data in topology or topologyMap elements search the system for a match of a TQL query. The following diagrams illustrate how the resulting topology and topologyMap structures are affected by the use of unique labels in the query.

Labels are user-specified names in the query for relations and configuration items in specific configurations. The labels specified in the query are used as the node labels in the returned map. If no labels are specified, the CI or Relation Type Name is used as the label in the resulting map. The following example illustrates specifying labels IISHost and DBHost in place of the default Host label, and labels ContainerIIS and ContainsDB in place of the default Container Link label.

### Example

This is a representation of a small IT universe model. There are three hosts: H1, H2, H3, which host Web servers (WS) and database managers (DB). WS1 resides on H1. DB1 and WS2 both reside on H2. DB2 resides on H3.

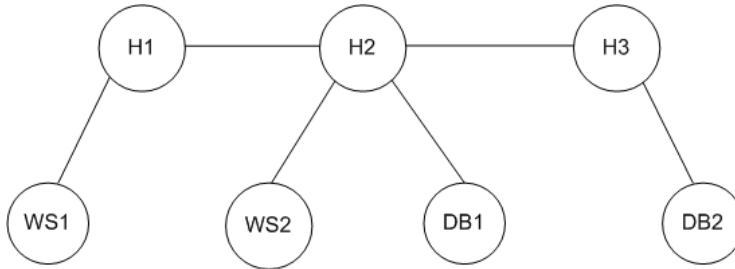

This query is defined using the default labels:

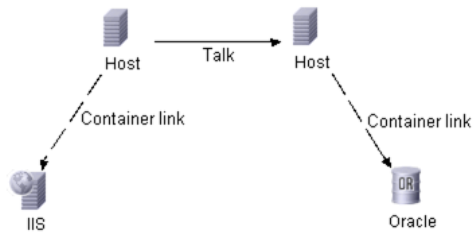

TQL with no unique labels

The result of running this TQL query on the IT universe can be a Topology or TopologyMap.

### Topology Response

CIs: H1,H2,H3,WS1,WS2,DB1,DB2  
 relations: H1-WS1, H1-H2, H2-H3, WS2-H2,DB1-H2, DB2-H3

## TopologyMap Response

```

CINode:
label: Host
CIs: H1,H2

CINode:
label: Host
CIs: H2,H3

CINode:
label: DB
CIs: DB1,DB2

CINode:
label: Webserver
CIs: IIS

relationNode:
label: talk
relations: H1-H2, H2-H3

relationNode:
label: Container Link
relations: WS1-H1, WS2-H2

relationNode:
label: Container Link
relations: DB2-H3, DB1-H2

```

In the above TopologyMap response, the first two CINodes contain identical Host labels, corresponding to the two Host configuration items in the query. Both of these CINodes contain host H2, with no indication of why H2 is duplicated.

The last two relationNodes contain identical Contained labels, corresponding to the two Container link relations in the query.

The duplications occur because no unique labels are specified in the query, resulting in the use of default labels, the type names Host and Container, in the map. To extract a more usable map, define queries with unique labels for each configuration to be matched, as shown in the following query.

This query is defined with unique labels:

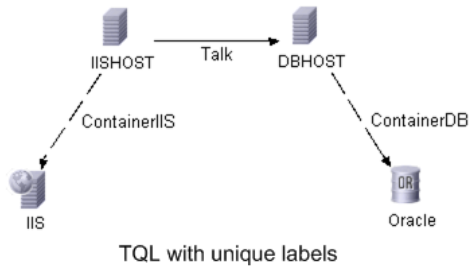

The topology result is identical to that of the TQL without unique labels. The topologyMap result, however, is different: Each label is now unique.

```
CINode:  
label: IISHOST  
Cls: H1, H2  
  
CINode:  
label: DBHOST  
Cls: H2, H3  
  
...  
  
relationNode:  
label: ContainerIIS  
relations: WS1-H1, WS2-H2  
  
relationNode:  
label: ContainerDB  
relations: DB2-H3, DB1-H2
```

In this map, it is clear why H2 is returned twice. The unique labels indicate that it is returned once as a Web server host and once as a database host.

---

**Tip:** Wherever possible in the UCMDB, apply unique, user-defined labels to specific configurations.

---

## Query the HP UCMDB Module

The HP UCMDB is queried using the APIs described in “HP UCMDB Module Query Methods” on page 337.

The queries and the returned UCMDB elements always contain real UCMDB IDs.

Some general information on queries is presented below.

For examples of the use of the query methods, see “Query Example” on page 364.

This section includes the following topics:

- ▶ “Just In Time Response Calculation” on page 333
- ▶ “Processing Large Responses” on page 334
- ▶ “Specifying Properties to Return” on page 334
- ▶ “HP UCMDB Module Query Methods” on page 337

### **Just In Time Response Calculation**

For all query methods, the UCMDB server calculates the values requested by the query method when the request is received, and returns results based on the latest data. The result is always calculated at the time the request is received, even if the TQL query is active and there exists a previously calculated result. Therefore, the results of running a query returned to the client application may be different than the results of the same query displayed on the user interface.

**Tip:** If your application uses the results of a given query more than once and the data is not expected to change significantly between uses of the result data, you can improve performance by having the client application store the data rather than repeatedly running the query.

---

## Processing Large Responses

The response to a query always includes the structures for the data requested by the query method, even if no actual data is being transmitted. For many methods where the data is a collection or map, the response also includes the `ChunkInfo` structure, comprised of `chunksKey` and `numberOfChunks`. The `numberOfChunks` field indicates the number of chunks containing data that must be retrieved.

The maximum transmission size of data is set by the system administrator. If the data returned from the query is larger than the maximum size, the data structures in the first response contain no meaningful information, and the value of the `numberOfChunks` field is 2 or greater. If the data is not larger than the maximum, the `numberOfChunks` field is 0 (zero), and the data is transmitted in the first response. Therefore, in processing a response, check the `numberOfChunks` value first. If it is greater than 1, discard the data in the transmission and request the chunks of data. Otherwise, use the data in the response.

For information on handling chunked data, see “`pullTopologyMapChunks`” on page 348 and “`releaseChunks`” on page 350.

## Specifying Properties to Return

Configuration Items and Relations generally have many properties. Some methods that return collections or graphs of these items accept input parameters that specify which property values to return with each item that matches the query. The UCMDB does not return empty properties. Therefore, the response to a query may have fewer properties than requested in the query.

This section describes the types of sets used to specify the properties to return. Properties can be referenced in two ways. First, properties can be referenced by their names. Second, they can be referenced by using names of predefined properties rules. Predefined properties rules are used by the UCMDB to create a list of real property names.

When an application references properties by name, it passes a `PropertiesList`.

---

**Tip:** Whenever possible, use a `PropertiesList` to specify the names of the properties in which you are interested, rather than a rule-based set. Using the predefined properties rules nearly always results in returning more properties than you need, and has a performance price.

---

There are two types of predefined properties: qualifier properties and simple properties.

To use qualifier properties, the client application passes a `QualifierProperties` element. `QualifierProperties` is a list of qualifiers that can be applied to properties. The UCMDB converts the list of qualifiers passed by the client application to the list of the properties to which at least one of the qualifiers apply. The values of those properties are returned with the `CI` elements or `Relation` elements.

To use simple rule-based properties, the client application passes a `SimplePredefinedProperty` or `SimpleTypedPredefinedProperty` element. These elements contain the name of the rule by which the UCMDB generates the list of properties to return. The rules that can be specified in a `SimplePredefinedProperty` or `SimpleTypedPredefinedProperty` element are `CONCRETE`, `DERIVED`, and `NAMING`.

### **Concrete Properties**

Concrete properties are the set of properties defined for the specified class type. The properties added by derived classes are not returned for instances of those derived classes.

A collection of instances returned by a method may consist of instances of a class specified in the method invocation and instances of classes that inherit from that class. The derived classes inherit the properties of the specified class. In addition, the derived classes extend the parent class by adding properties.

Concrete properties are the properties defined in the specified class. Properties added by classes derived from the specified class are not included.

For example:

Class T1 has properties P1 and P2. Class T11 inherits from T1 and extends T1 with properties P21 and P22.

The collection of CIs of type T1 includes the instances of T1 and T11. The concrete properties of all instances in this collection are P1 and P2.

### **Derived Properties**

Derived properties are the set of properties defined for the specified class type and, for each derived class, the properties added by the derived class.

The derived properties of a class are all the properties inherited from the parent class and all the properties added by the derived class.

Continuing the example from concrete properties, the derived properties of instances of T1 are P1 and P2. The derived properties of instances of T11 are P1, P2, P21, and P22.

### **Naming Properties**

The naming properties are `display_label` and `data_name`.

### **Other Property Specification Elements**

➤ **PredefinedProperties**

`PredefinedProperties` can contain a `QualifierProperties` element and a `SimplePredefinedProperty` element for each of the other possible rules. A `PredefinedProperties` set does not necessarily contain all types of lists.

➤ **PredefinedTypedProperties**



`PredefinedTypedProperties` is used to apply a different set of properties to each CI type. `PredefinedTypedProperties` can contain a `QualifierProperties` element and a `SimpleTypedPredefinedProperty` element for each of the other applicable rules. Because `PredefinedTypedProperties` is applied to each type individually, Derived properties are not relevant. A `PredefinedProperties` set does not necessarily contain all applicable types of lists.

► `CustomProperties`

`CustomProperties` can contain any combination of the basic `PropertiesList` and the rule-based property lists. The properties filter is the union of all the properties returned by all the lists.

► `CustomTypedProperties`

`CustomTypedProperties` can contain any combination of the basic `PropertiesList` and the applicable the rule-based property lists. The properties filter is the union of all the properties returned by all the lists.

► `TypedProperties`

`TypedProperties` is used to pass a different set of properties for each CI type. `TypedProperties` is a collection of pairs composed of type names and properties sets of all types. Each properties set is applied only to the corresponding type.

## HP UCMDB Module Query Methods

### **getChangedCIs**

`getChangedCIs` returns the change data for all CIs related to the specified CIs.

**Input:**

Parameter	Comment
<code>cmdbContext</code>	For details, see “ <code>CmdbContext</code> ” on page 388.
<code>ids</code>	The list of the IDs of the root CIs whose related CIs are checked for changes. Only real UCMDB IDs are valid in this collection.

Parameter	Comment
fromDate	The beginning of the period in which to check if CIs changed.
toDate	The end of the period in which to check if CIs changed.

**Output:**

Parameter	Comment
changeDataInfo	Zero or more collections of ChangedDataInfo elements.

**getCIsByID**

getCIsByID retrieves configuration items by their UCMDB IDs.

**Input:**

Parameter	Comment
cmdbContext	For details, see “CmdbContext” on page 388.
CIsTypedProperties	A typed properties collection. For details, see “TypedProperties” on page 337.
IDs	Only real UCMDB IDs are valid in this collection.

**Output:**

Parameter	Comment
CIs	Collection of CI elements.
chunkInfo	For details, see “ChunkInfo” on page 393 and “Processing Large Responses” on page 334.

**getCIsByType**

getCIsByType retrieves configuration items according to the type specified.

`getCIsByType` returns the collection of configuration items of the specified type and of all types that inherit from the specified type.

**Input:**

Parameter	Comment
<code>cmdbContext</code>	For details, see “ <i>CmdbContext</i> ” on page 388.
<code>type</code>	The class name. For details, see “ <i>Type Name</i> ” on page 390.
<code>properties</code>	The data to be returned on each configuration item. For details, see “ <i>CustomProperties</i> ” on page 337.

**Output:**

Parameter	Comment
<code>CIs</code>	Collection of CI elements.
<code>chunkInfo</code>	For details, see “ <i>ChunkInfo</i> ” on page 393 and “ <i>Processing Large Responses</i> ” on page 334.

**getFilteredCIsByType**

`getFilteredCIsByType` retrieves the configuration items of the specified type that meet the conditions.

`getFilteredCIsByType` uses conditions. A condition is comprised of a `name` field containing the name of a property, an `operator` field containing a comparison operator, and an optional `value` field, containing a value or list of values. Together, they form a boolean expression: `<item>.property.value [operator] <condition>.value`.

For example, if the condition name is `root_actualdeletionperiod`, the condition value is 40 and the operator is `Equal`, the boolean statement is: `<item>.root_actualdeletionperiod.value == 40`. The query returns all items whose `root_actualdeletionperiod` is 40, assuming there are no other conditions.

If the `conditionsLogicalOperator` argument is *AND*, the query returns the items that meet all conditions in the `conditions` collection. If `conditionsLogicalOperator` is *OR*, the query returns the items that meet at least one of the conditions in the `conditions` collection.

The following table lists the comparison operators:

Operator	Type of condition/comments
ChangedDuring	<p>Date</p> <p>This is a range check. The condition value is specified in hours. If the value of the date property is in the range of the time the method is invoked plus or minus the condition value, then the condition is true.</p> <p>For example, if the condition value is 24, the condition is true if the value of the date property is between yesterday at this time and tomorrow at this time.</p> <p><b>Note:</b> The name <code>ChangedDuring</code> is kept to preserve backward compatibility. In previous versions, the operator was used only with create and modify time properties.</p>
Equal	String and numerical
EqualIgnoreCase	String
Greater	Numerical
GreaterEqual	Numerical
In	<p>String, numerical, and list</p> <p>The condition's value is a list. The condition is true if the value of the property is one of the values in the list.</p>

Operator	Type of condition/comments
InList	<p>List</p> <p>The condition's value and the property's value are lists.</p> <p>The condition is true if all the values in the condition's list are also in the item's property list. There may be more property values than specified in the condition without effecting the truth of the condition.</p>
IsNull	<p>String, numerical and list</p> <p>The item's property has no value. When operator IsNull is used, the value of the condition is ignored, and in some cases can be nil.</p>
Less	Numerical
LessEqual	Numerical
Like	<p>String</p> <p>The condition's value is a substring of the value of the property's value. The condition's value must be bracketed with percent signs (%). For example, %Bi% matches 'Bismark' and 'Bay of Biscay', but not 'biscuit'.</p>
LikeIgnoreCase	<p>String</p> <p>Use the LikeIgnoreCase operator as you use the Like operator. The match, however is not case-sensitive. Therefore, %Bi% matches 'biscuit'.</p>

Operator	Type of condition/comments
NotEqual	String and numerical
UnchangedDuring	<p>Date</p> <p>This is a range check. The condition value is specified in hours. If the value of the date property is in the range of the time the method is invoked plus or minus the condition value, then the condition is false. If it is outside that range, the condition is true</p> <p>For example, if the condition value is 24, the condition is true if the value of the date property is before yesterday at this time or after tomorrow at this time.</p> <p><b>Note:</b> The name UnchangedDuring is kept to preserve backward compatibility. In previous versions, the operator was used only with create and modify time properties.</p>

Example of setting up a condition:

```
FloatCondition fc = new FloatCondition();
FloatProp fp = new FloatProp();
fp.setName("attr_name");
fp.setValue(11);
fc.setCondition(fp);
fc.setFloatOperator(FloatCondition.floatOperatorEnum.Equal);
```

**Input:**

Parameter	Comment
cmdbContext	For details, see “CmdbContext” on page 388.
type	The class name, see “Type Name” on page 390. The type can be any of the types defined using the CI Type Manager in the UCMDDB user interface

Parameter	Comment
properties	The data to be returned on each configuration item. (Called the Query Layout in the user interface) For details, see “CustomProperties” on page 337.
conditions	A collection of name-value pairs and the operators that relate one to the other. For example, <i>host_hostname like QA</i> .
conditionsLogicalOperator	If <i>AND</i> , all of the conditions must be met. If <i>OR</i> , at least one of the conditions must be met.

**Output:**

Parameter	Comment
CIs	Collection of CI elements.
chunkInfo	For details, see “ChunkInfo” on page 393 and “Processing Large Responses” on page 334.

**getQueryNameOfView**

getQueryNameOfView retrieves the name of the query (TQL) on which the specified view is based.

**Input:**

Parameter	Comment
cmdbContext	For details, see “CmdbContext” on page 388.
viewName	The name of a view, that is, a sub-set of the IT universe in the UCMDB.

**Output:**

Parameter	Comment
queryName	The name of the TQL in the UCMDB on which the view is based.

**getTopologyQueryExistingResultByName**

getTopologyQueryExistingResultByName Retrieves the most recent result of running the specified TQL. The call does not run the TQL. If there are not results from a previous run, nothing is returned.

**Input:**

Parameter	Comment
cmdbContext	For details, see “CmdbContext” on page 388.
queryName	The name of a TQL.
CIsTypedProperties	Properties used to filter the results.

**Output:**

Parameter	Comment
queryName	The name of the TQL in the UCMDB on which the view is based.

**getTopologyQueryResultCountByName**

getTopologyQueryResultCountByName retrieves the number of instances of each node that matches the specified query.

**Input:**

Parameter	Comment
cmdbContext	For details, see “CmdbContext” on page 388.
queryName	The name of a TQL.
countInvisible	If true, the output includes CIs defined as invisible in the query.



**Output:**

Parameter	Comment
queryName	The name of the TQL in the UCMDB on which the view is based.

**executeTopologyQueryByName**

executeTopologyQueryByName retrieves the topology map that matches the specified query.

---

**Tip:** The map contains more information and is easier to understand if the label for each `CINode` and each `relationNode` in the TQL is unique. For details, see “Create Queries to Return Unambiguous TopologyMap Elements” on page 329.

---

**Input:**

Parameter	Comment
cmdbContext	For details, see “CmdbContext” on page 388.
queryName	The name of the TQL in the UCMDB for which to get the map.
CIsTypedProperties	The properties for the query.

**Output:**

Parameter	Comment
topologyMap	For details, see “TopologyMap” on page 393.

**executeTopologyQueryByNameWithParameters**

executeTopologyQueryByNameWithParameters retrieves a topologyMap that matches the specified parameterized query.

The values for the query parameters are passed in the `parameterizedNodes` argument. The specified TQL must have unique labels defined for each `CINode` and each `relationNode` or the method invocation fails.

**Input:**

Parameter	Comment
<code>cmdbContext</code>	For details, see “ <code>CmdbContext</code> ” on page 388.
<code>queryName</code>	The name of the parameterized TQL in the UCMDB for which to get the map.
<code>parameterizedNodes</code>	The conditions each node must meet to be included in the query results.
<code>CIsTypedProperties</code>	The properties for the query.

**Output:**

Parameter	Comment
<code>topologyMap</code>	For details, see “ <code>TopologyMap</code> ” on page 393.
<code>chunkInfo</code>	For details, see “ <code>ChunkInfo</code> ” on page 393 and “ <code>Processing Large Responses</code> ” on page 334.

**executeTopologyQueryWithParameters**

`executeTopologyQueryWithParameters` retrieves a `topologyMap` that matches the parameterized query.

The query is passed in the `queryXML` argument. The values for the query parameters are passed in the `parameterizedNodes` argument. The TQL must have unique labels defined for each `CINode` and each `relationNode`.

`executeTopologyQueryWithParameters` is used to pass ad-hoc queries, rather than accessing a query defined in the UCMDB. You can use this method when you do not have access to the UCMDB user interface to define a query, or when you do not want to save the query to the database.

**Input:**

Parameter	Comment
cmdbContext	For details, see “CmdbContext” on page 388.
queryXML	An XML representation of a TQL.
parameterizedNodes	The conditions each node must meet to be included in the query results.

**Output:**

Parameter	Comment
topologyMap	For details, see “TopologyMap” on page 393.
chunkInfo	For details, see “ChunkInfo” on page 393 and “Processing Large Responses” on page 334.

**getCI Neighbours**

getCI Neighbours returns the immediate neighbors of the specified CI.

For example, if the query is on the neighbors of CI *A*, and CI *A* contains CI *B* which uses CI *C*, CI *B* is returned, but CI *C* is not.

Only neighbors of the specified type are returned.

**Input:**

Parameter	Comment
cmdbContext	For details, see “CmdbContext” on page 388.
ID	The ID of the configuration item for which to retrieve the neighbors. This must be a real UCMDB ID.

Parameter	Comment
neighbourType	The Configuration Item Type Name of the neighbors to retrieve. Neighbors of the specified type and of types derived from that type are returned. For details, see “Type Name” on page 390.
CIProperties	The data to be returned on each configuration item, called the Query Layout in the user interface. For details, see “TypedProperties” on page 337.
relationProperties	The data to be returned on each relation (called the Query Layout in the user interface). For details, see “TypedProperties” on page 337

**Output:**

Parameter	Comment
topology	For details, see “Topology” on page 392.
comments	Disregard this value. It is for internal use by HP.

**pullTopologyMapChunks**

pullTopologyMapChunks retrieves one of the chunks that contain the response to a method.

Each chunk contains a topologyMap that is part of the response. The first chunk is numbered 1, so the retrieval loop counter iterates from 1 to `<response object>.getChunkInfo().getNumberOfChunks()`.

For details, see “ChunkInfo” on page 393 and “Query the HP UCMDB Module” on page 333.

The client application must handle the partial maps. See the example of handling a CIs collection below and the example of merging chunks to a map, mergeMaps, in the “Query Example” on page 364.

**Input:**

Parameter	Comment
cmdbContext	For details, see “CmdbContext” on page 388.
ChunkRequest	The number of the chunk to retrieve and the ChunkInfo that was returned by the query method.

**Output:**

Parameter	Comment
topologyMap	For details, see “TopologyMap” on page 393.
comments	Disregard this value. It is for internal use by HP.

This is an example of handling chunks:

```

GetCIsByType request =
    new GetCIsByType(cmdbContext, typeName, customProperties);
GetCIsByTypeResponse response =
    ucmbService.getCIsByType(request);
ChunkRequest chunkRequest = new ChunkRequest();
chunkRequest.setChunkInfo(response.getChunkInfo());
for(int j=1 ; j < response.getChunkInfo().getNumberOfChunks() ; j++) {
    chunkRequest.setChunkNumber(j);
    PullTopologyMapChunks req = new PullTopologyMapChunks(cmdbContext,
    chunkRequest);
    PullTopologyMapChunksResponse res =
        ucmbService.pullTopologyMapChunks(req);
    for(int m=0 ;
        m < res.getTopologyMap().getCINodes().sizeCINodeList() ;
        m++) {
        CIs cis =
            res.getTopologyMap().getCINodes().getCINode(m).getCIs();
        for(int i=0 ; i < cis.sizeCICollection() ; i++) {
            // your code to process the CIs
        }
    }
}
}

```

## releaseChunks

releaseChunks frees the memory of the chunks that contain the data from the query.

---

**Tip:** The server discards the data after ten minutes. Calling this method to discard the data as soon as it has been read conserves server resources.

---

### Input:

Parameter	Comment
cmdbContext	For details, see “CmdbContext” on page 388.
chunksKey	The identifier of the data on the server that was chunked. The key is an element of ChunkInfo.

## Update the HP UCMDB Module

Update the UCMD with the update APIs. For details of the API methods, see “HP UCMDB Module Update Methods” on page 352.

For examples of the use of the update methods, see “Update Example” on page 379.

This section includes the following topics:

- “HP UCMDB Update Parameters” on page 350
- “Use of ID Types with Update Methods” on page 351
- “HP UCMDB Module Update Methods” on page 352

### HP UCMDB Update Parameters

This topic describes the parameters used only by the service’s update methods. For details, refer to the schema documentation.

## **CIsAndRelationsUpdates**

The `CIsAndRelationsUpdates` type consists of `CIsForUpdate`, `relationsForUpdate`, `referencedRelations`, and `referencedCIs`. A `CIsAndRelationsUpdates` instance does not necessarily have all three elements.

`CIsForUpdate` is a CIs collection. `relationsForUpdate` is a `Relations` collection. The CI and relation elements in the collections have a `props` element. When creating a CI or relation, properties that have either the required attribute or the key attribute in the CI Type definition must be populated with values. The items in these collections are updated or created by the method.

`referencedCIs` and `referencedRelations` are collections of configuration items that are already defined in the UCMDB. The elements in the collection are identified with a temporary ID in conjunction with all the key properties. These items are used to resolve the identities of CIs and Relations for update. They are never created or updated by the method.

Each of the CI and relation elements in these collections has a `properties` collection. New items are created with the property values in these collections.

## **Use of ID Types with Update Methods**

The following describes all the possibilities with regard to ID types and configuration items and relations. When the ID is not a real CMDB ID, the type and key attributes are required.

### **Deleting or Updating Configuration Items**

A temporary or empty ID may be used by the client when calling a method to delete or update an item. In this case, the CI type and the key attributes that identify the CI must be set.

### **Deleting or Updating Relations**

When deleting or updating relations, the relation ID may be empty, temporary, or real.

If a CI's ID is temporary, then the CI must be passed in the `referencedCIs` collection and its key attributes must be specified. See `referencedCIs` in the `CIsAndRelationsUpdates` topic in this section.

### **Inserting New Configuration Items into the UCMDB**

It is possible to use either an empty ID or a temporary ID to insert a new CI. However, if the ID is empty, the server cannot return the real UCMDB ID in the structure `createIDsMap` because there is no `clientID`. For details, see “`addCIsAndRelations`” on page 352.

### **Inserting New Relations into the UCMDB**

The relation ID can be either temporary or empty. However, if the relation is new but the configuration items on either end of the relation are already defined in the UCMDB, then those Configuration Items that already exist must be identified by a real UCMDB ID or be specified in a `referencedCIs` collection.

## **HP UCMDB Module Update Methods**

### **`addCIsAndRelations`**

`addCIsAndRelations` adds or updates Configuration Items and relations.

If the Configuration Items or relations do not exist in UCMDB, they are added and their properties are set according to the contents of the `CIsAndRelationsUpdates` argument. If they already exist, they are updated with the new data if `updateExisting` is true. If `updateExisting` is false, `CIsAndRelationsUpdates` cannot reference existing configuration items or relations. Attempting to reference existing items when `updateExisting` is false results in an exception.

If `updateExisting` is true, the add or update operation is performed without validating the CIs, regardless of the value of `ignoreValidation`.

If `updateExisting` is false and `ignoreValidation` is true, the add operation is performed without validating the CIs. If `updateExisting` is false and `ignoreValidation` is false, the the CIs are validated before the add operation.

Relations are never validated.



CreatedIDsMap is a map or dictionary of type ClientIDToCmdbID that connects the client's temporary IDs with the corresponding real UCMDB IDs.

**Input:**

Parameter	Comment
cmdbContext	For details, see “CmdbContext” on page 388.
updateExisting	Set to <i>true</i> to update items that already exist in the UCMDB. Set to <i>false</i> to throw an exception if any item already exists.
CIsAndRelationsUpdates	The items to update or create. For details, see “CIsAndRelationsUpdates” on page 351.
ignoreValidation	If is true, no check is performed before updating the uCMDB.

**Output:**

Parameter	Comment
CreatedIDsMap	The map of client IDs to UCMDB IDs. For details, see “addCIsAndRelations” on page 352.
comments	Disregard this value. It is for internal use by HP.

**deleteCIsAndRelations**

deleteCIsAndRelations removes the specified configuration items and relations from the UCMDB.

When a CI is deleted and the CI is one end of one or more Relation items, those Relation items are also deleted.

**Input:**

Parameter	Comment
cmdbContext	For details, see “CmdbContext” on page 388.
CIsAndRelationsUpdates	The items to delete. For details, see “CIsAndRelationsUpdates” on page 351

**updateCIsAndRelations**

updateCIsAndRelations updates the specified Configuration Items and Relations.

The update uses the property values from the CIsAndRelationsUpdates argument. If any of the configuration items or relations do not exist in the UCMDB, an exception is thrown.

CreatedIDsMap is a map or dictionary of type ClientIDToCmdbID that connects the client’s temporary IDs with the corresponding real UCMDB IDs.

**Input:**

Parameter	Comment
cmdbContext	For details, see “CmdbContext” on page 388.
CIsAndRelationsUpdates	The items to update. For details, see “CIsAndRelationsUpdates” on page 351
ignoreValidation	If true, no check is performed before updating the uCMDB

**Output:**

Parameter	Comment
CreatedIDsMap	The map of client IDs to UCMDB IDs. For details, see “addCIsAndRelations” on page 352.

## Query the HP UCMDB Module Class Model

The class model methods return information about CI and Relation types. The class model is configured using the **CI Type Manager** in the UCMDB user interface.

For examples of the use of the class model methods, see “Class Model Example” on page 383.

This section includes the following topics:

- “HP UCMDB Module Class Model (CIT) Methods” on page 355

### HP UCMDB Module Class Model (CIT) Methods

The following methods return information about CI and Relation types.

#### **getClassAncestors**

getClassAncestors retrieves the path between the given CI Type and its root, including the root.

#### **Input:**

Parameter	Comment
cmdbContext	For details, see “CmdbContext” on page 388.
className	The type name. For details, see “Type Name” on page 390.

#### **Output:**

Parameter	Comment
classHierarchy	A collection of pairs of class names and parent class name.
comments	Disregard this value. It is for internal use by HP.

#### **getAllClassesHierarchy**

getAllClassesHierarchy retrieves the entire class model tree.

**Input:**

Parameter	Comment
cmdbContext	For details, see “CmdbContext” on page 388.

**Output:**

Parameter	Comment
classesHierarchy	A collection of pairs of class name and parent class name.
comments	Disregard this value. It is for internal use by HP.

**getCmdbClassDefinition**

getCmdbClassDefinition retrieves information about the specified class.

If you use getCmdbClassDefinition to retrieve the key attributes, you must also query the parent classes up to the base class. getCmdbClassDefinition identifies as key attributes only those attributes with the ID\_ATTRIBUTE set in the class definition specified by className. Inherited key attributes are not recognized as key attributes of the specified class. Therefore, the complete list of key attributes for the specified class is the union of all the keys of the class and of all its parents, up to the root.

**Input:**

Parameter	Comment
cmdbContext	For details, see “CmdbContext” on page 388.
className	The type name. For details, see “Type Name” on page 390.

**Output:**

Parameter	Comment
cmdbClass	The class definition, consisting of name, classType, displayLabel, description, parentName, qualifiers, and attributes.
comments	Disregard this value. It is for internal use by HP.

## Query for Impact Analysis

The Identifier in the impact analysis methods points to the service's response data. It is unique for the current response and is discarded from the server's memory cache after 10 minutes of non-use.

For examples of the use of the impact analysis methods, see “Impact Analysis Example” on page 384.

### HP UCMDB Module Impact Analysis Methods

#### **calculateImpact**

calculateImpact calculates what other configuration items are affected by the given CI according to the rules defined in the UCMDB.

This shows the effect of an event triggering of the rule. The identifier output of calculateImpact is used as input for getImpactPath.

**Input:**

Parameter	Comment
cmdbContext	For details, see “CmdbContext” on page 388.
impactCategory	The type of event that would trigger the rule being simulated.
IDs	A collection of ID elements.

Parameter	Comment
impactRulesNames	A collection of ImpactRuleName elements.
severity	The severity of the triggering event.

**Output:**

Parameter	Comment
impactTopology	For details, see “Topology” on page 392.
identifier	The key to the server response.

**getImpactPath**

getImpactPath retrieves the topology graph of the path between the affected CI and the CI that affects it.

The identifier output of calculateImpact is the used as the identifier input argument of getImpactPath.

**Input:**

Parameter	Comment
cmdbContext	For details, see “CmdbContext” on page 388.
identifier	The key to the server response that was returned by calculateImpact.
relation	A Relation based on one of the ShallowRelations returned by calculateImpact in the impactTopology element.

**Output:**

Parameter	Comment
impactPathTopology	A CIs collection and an ImpactRelations collection.
comments	Disregard this value. It is for internal use by HP.

An ImpactRelations element consists of an ID, type, end1ID, end2ID, a rule, and an action.

### **getImpactRulesByNamePrefix**

getImpactRulesByNamePrefix retrieves rules using a prefix filter.

This method applies to impact rules that are named with a prefix that indicates the context to which they apply, for example, *SAP\_myrule*, *ORA\_myrule*, and so on. This method filters all impact rule name for those beginning with the prefix specified by the ruleNamePrefixFilter argument.

#### **Input:**

Parameter	Comment
cmdbContext	For details, see “CmdbContext” on page 388.
ruleNamePrefixFilter	A string containing the first letters of the rule names to match.

#### **Output:**

Parameter	Comment
impactRules	impactRules is composed of zero or more impactRule. An impactRule, which specifies the effect of a change, is composed of ruleName, description, queryName, and isActive.

## Use Cases

The following use cases assume two systems:

- ▶ HP Universal CMDB server
- ▶ A third-party system that contains a repository of configuration items

This section includes the following topics:

- ▶ “Populating the UCMDB” on page 360
- ▶ “Querying the UCMDB” on page 360
- ▶ “Querying the Class Model” on page 361
- ▶ “Analyzing Change Impact” on page 361

### **Populating the UCMDB**

Use cases:

- ▶ A third-party asset management updates the UCMDB with information available only in asset management
- ▶ A number of third-party systems populate the UCMDB to create a central CMDB that can track changes and perform impact analysis
- ▶ A third-party system creates Configuration Items and Relations according to third-party business logic to leverage the CMDB query capabilities

### **Querying the UCMDB**

Use cases:

- ▶ A third-party system gets the Configuration Items and Relations that represent the SAP system by getting the results of the SAP TQL
- ▶ A third-party system gets the list of Oracle servers that have been added or changed in the last five hours
- ▶ A third-party system gets the list of servers whose host name contains the substring *lab*
- ▶ A third-party system finds the elements related to a given CI by getting its neighbors



## Querying the Class Model

Use cases:

- A third-party system enables users to specify the set of data to be retrieved from the UCMDB. A user interface can be built over the class model to show users the possible properties and prompt them for required data. The user can then choose the information to be retrieved.
- A third-party system explores the class model when the user cannot access the UCMDB user interface.

## Analyzing Change Impact

Use case:

A third-party system outputs a list of the business services that could be impacted by a change on a specified host.

## Examples

This section includes the following topics:

- “The Example Base Class” on page 361
- “Query Example” on page 364
- “Update Example” on page 379
- “Class Model Example” on page 383
- “Impact Analysis Example” on page 384

### The Example Base Class

```
package com.hp.ucmdb.demo;
```

```
import com.hp.ucmdb.generated.services.UcmdbService;
import com.hp.ucmdb.generated.services.UcmdbServiceStub;
import com.hp.ucmdb.generated.types.CmdbContext;
import org.apache.axis2.AxisFault;
```

```
import org.apache.axis2.transport.http.HTTPConstants;
import org.apache.axis2.transport.http.HttpTransportProperties;

import java.net.MalformedURLException;
import java.net.URL;

/**
 * User: hbarkai
 * Date: Jul 12, 2007
 */
abstract class Demo {

    UcmdbService stub;
    CmdbContext context;

    public void initDemo() {
        try {
            setStub(createUcmdbService("admin", "admin"));
            setContext();
        } catch (Exception e) {
            //handle exception
        }
    }

    public UcmdbService getStub() {
        return stub;
    }

    public void setStub(UcmdbService stub) {
        this.stub = stub;
    }

    public CmdbContext getContext() {
        return context;
    }

    public void setContext() {
        CmdbContext context = new CmdbContext();
    }
}
```

```

    context.setCallerApplication("demo");
    this.context = context;
}

//connection to service - for axis2/jibx client

private static final String PROTOCOL = "http";
private static final String HOST_NAME = "host_name";
private static final int PORT = 8080;
private static final String FILE = "/axis2/services/UcmdbService";

protected UcmdbService createUcmdbService
    (String username, String password) throws Exception{
    URL url;
    UcmdbServiceStub serviceStub;
    try {
        url = new URL
            (Demo.PROTOCOL, Demo.HOST_NAME,
            Demo.PORT, Demo.FILE);
        serviceStub = new UcmdbServiceStub(url.toString());
        HttpTransportProperties.Authenticator auth =
            new HttpTransportProperties.Authenticator();
        auth.setUsername(username);
        auth.setPassword(password);
serviceStub._getServiceClient().getOptions().setProperty
        (HTTPConstants.AUTHENTICATE,auth);

        } catch (AxisFault axisFault) {
            throw new Exception
                ("Failed to create SOAP adapter for "
                + Demo.HOST_NAME , axisFault);
        } catch (MalformedURLException e) {

            throw new Exception
                ("Failed to create SOAP adapter for "
                + Demo.HOST_NAME, e);
        }
    }
    return serviceStub;
}

```

```
}
```

## Query Example

```
package com.hp.ucmdb.demo;

import com.hp.ucmdb.generated.params.query.*;
import com.hp.ucmdb.generated.services.UcmdbFaultException;
import com.hp.ucmdb.generated.services.UcmdbService;
import com.hp.ucmdb.generated.types.*;
import com.hp.ucmdb.generated.types.props.*;

import java.rmi.RemoteException;

public class QueryDemo extends Demo{

    UcmdbService stub;
    CmdbContext context;

    public void getCIsByTypeDemo() {
        GetCIsByType request = new GetCIsByType();
        //set cmdbcontext
        CmdbContext cmdbContext = getContext();
        request.setCmdbContext(cmdbContext);
        //set CIs type
        request.setType("anyType");
        //set CIs properties to be retrieved
        CustomProperties customProperties = new CustomProperties();
        PredefinedProperties predefinedProperties =
            new PredefinedProperties();
        SimplePredefinedProperty simplePredefinedProperty =
            new SimplePredefinedProperty();
        simplePredefinedProperty.setName
            (SimplePredefinedProperty.nameEnum.DERIVED);
        SimplePredefinedPropertyCollection
            simplePredefinedPropertyCollection =
```

```

        new SimplePredefinedPropertyCollection();
    simplePredefinedPropertyCollection.addSimplePredefinedProperty
        (simplePredefinedProperty);
    predefinedProperties.setSimplePredefinedProperties
        (simplePredefinedPropertyCollection);
    customProperties.setPredefinedProperties(predefinedProperties);
    request.setProperties(customProperties);
    try {
        GetCIsByTypeResponse response =
            getStub().getCIsByType(request);
        TopologyMap map =
            getTopologyMapResultFromCIs
                (response.getCIs(), response.getChunkInfo());
    } catch (RemoteException e) {
        //handle exception
    } catch (UcmdbFaultException e) {
        //handle exception
    }
}

public void getCIsByIdDemo() {
    GetCIsById request = new GetCIsById();
    CmdbContext cmdbContext = getContext();
    //set cmdbcontext
    request.setCmdbContext(cmdbContext);
    //set ids
    ID id1 = new ID();
    id1.setBase("cmdbobjectidCIT1");
    ID id2 = new ID();
    id2.setBase("cmdbobjectidCIT2");
    IDs ids = new IDs();
    ids.addID(id1);
    ids.addID(id2);
    request.setIDs(ids);
    //set CIs properties to be retrieved
    TypedPropertiesCollection properties =
        new TypedPropertiesCollection();

```

```
TypedProperties typedProperties1 =
    new TypedProperties();
typedProperties1.setType("CIT1");
CustomTypedProperties customProperties1 =
    new CustomTypedProperties();
PredefinedTypedProperties predefinedProperties1 =
    new PredefinedTypedProperties();
SimpleTypedPredefinedProperty simplePredefinedProperty1 =
    new SimpleTypedPredefinedProperty();
simplePredefinedProperty1.setName
    (SimpleTypedPredefinedProperty.nameEnum.CONCRETE);
SimpleTypedPredefinedPropertyCollection
    simplePredefinedPropertyCollection1 =
        new SimpleTypedPredefinedPropertyCollection();
simplePredefinedPropertyCollection1
    .addSimpleTypedPredefinedProperty
        (simplePredefinedProperty1);
```

```
predefinedProperties1.
    setSimpleTypedPredefinedProperties
        (simplePredefinedPropertyCollection1);
customProperties1.
    setPredefinedTypedProperties
        (predefinedProperties1);
typedProperties1.setProperties(customProperties1);
properties.addTypedProperties(typedProperties1);
```

```
TypedProperties typedProperties2 =
    new TypedProperties();
typedProperties2.setType("CIT2");
CustomTypedProperties customProperties2 =
    new CustomTypedProperties();
PredefinedTypedProperties predefinedProperties2 =
    new PredefinedTypedProperties();
SimpleTypedPredefinedProperty simplePredefinedProperty2 =
    new SimpleTypedPredefinedProperty();
simplePredefinedProperty2.setName
    (SimpleTypedPredefinedProperty.nameEnum.NAMING);
SimpleTypedPredefinedPropertyCollection
```

```

        simplePredefinedPropertyCollection2 =
            new SimpleTypedPredefinedPropertyCollection();
simplePredefinedPropertyCollection2.
    addSimpleTypedPredefinedProperty
        (simplePredefinedProperty2);
predefinedProperties2.setSimpleTypedPredefinedProperties
    (simplePredefinedPropertyCollection2);
customProperties2.setPredefinedTypedProperties
    (predefinedProperties2);
typedProperties2.setProperties(customProperties2);
properties.addTypedProperties(typedProperties2);

request.setClsTypedProperties(properties);
try {
    GetClsByIdResponse response =
        getStub().getClsById(request);
    Cls cis = response.getCls();
} catch (RemoteException e) {
    //handle exception
} catch (UcmdbFaultException e) {
    //handle exception
}
}

public void getFilteredClsByTypeDemo() {
    GetFilteredClsByType request = new GetFilteredClsByType();
    CmdbContext cmdbContext = getContext();
    //set cmdbcontext
    request.setCmdbContext(cmdbContext);
    //set Cls type
    request.setType("anyType");
    //sets Filter conditions
    Conditions conditions = new Conditions();
    IntConditions intConditions = new IntConditions();
    IntCondition intCondition = new IntCondition();
    IntProp intProp = new IntProp();

```

```

intProp.setName("int_attr1");
intProp.setValue(100);
intCondition.setCondition(intProp);
intCondition.setIntOperator
    (IntCondition.intOperatorEnum.Greater);
intConditions.addIntCondition(intCondition);
conditions.setIntConditions(intConditions);
request.setConditions(conditions);
//set logical operator for conditions
request.setConditionsLogicalOperator
    (GetFilteredCIsByType.conditionsLogicalOperatorEnum.AND);
//set CIs properties to be retrieved
CustomProperties customProperties =
    new CustomProperties();
PredefinedProperties predefinedProperties =
    new PredefinedProperties();
SimplePredefinedProperty simplePredefinedProperty =
    new SimplePredefinedProperty();
simplePredefinedProperty.setName
    (SimplePredefinedProperty.nameEnum.NAMING);
SimplePredefinedPropertyCollection
    simplePredefinedPropertyCollection =
        new SimplePredefinedPropertyCollection();
simplePredefinedPropertyCollection.
    addSimplePredefinedProperty
        (simplePredefinedProperty);
predefinedProperties.setSimplePredefinedProperties
    (simplePredefinedPropertyCollection);
customProperties.setPredefinedProperties
    (predefinedProperties);

request.setProperties(customProperties);
try {
    GetFilteredCIsByTypeResponse response =
        getStub().getFilteredCIsByType(request);
    TopologyMap map =
        getTopologyMapResultFromCIs
            (response.getCIs(), response.getChunkInfo());
} catch (RemoteException e) {

```



```

        //handle exception
    } catch (UcmdbFaultException e) {
        //handle exception
    }
}

public void executeTopologyQueryByNameDemo() {
    ExecuteTopologyQueryByName request = new
ExecuteTopologyQueryByName();
    CmdbContext cmdbContext = getContext();
    //set cmdbcontext
    request.setCmdbContext(cmdbContext);
    //set query name
    request.setQueryName("queryName");

    try {
        ExecuteTopologyQueryByNameResponse response =
            getStub().executeTopologyQueryByName(request);
        TopologyMap map =
            getTopologyMapResult
                (response.getTopologyMap(), response.getChunkInfo());
    } catch (RemoteException e) {
        //handle exception
    } catch (UcmdbFaultException e) {
        //handle exception
    }
}

// assume the follow query was defined at UCMDDB
// Query Name: exampleQuery
// Query sketch:
//
//             Host
//             / \
//             ip Disk

```

```

// Query Parameters:
//   Host-
//     host_os (like)
//   Disk-
//     disk_failures (equal)

public void executeTopologyQueryByNameWithParametersDemo() {
    ExecuteTopologyQueryByNameWithParameters request =
        new ExecuteTopologyQueryByNameWithParameters();
    CmdbContext cmdbContext = getContext();
    //set cmdbcontext
    request.setCmdbContext(cmdbContext);
    //set query name
    request.setQueryName("queryName");
    //set parameters
    ParameterizedNode hostParametrizedNode =
        new ParameterizedNode();
    hostParametrizedNode.setNodeLabel("Host");
    CIProperties parameters = new CIProperties();
    StrProps strProps = new StrProps();
    StrProp strProp = new StrProp();
    strProp.setName("host_os");
    strProp.setValue("%2000%");
    strProps.addStrProp(strProp);
    parameters.setStrProps(strProps);
    hostParametrizedNode.setParameters(parameters);
    request.addParameterizedNodes(hostParametrizedNode);
    ParameterizedNode diskParametrizedNode =
        new ParameterizedNode();
    diskParametrizedNode.setNodeLabel("Disk");
    CIProperties parameters1 = new CIProperties();
    IntProps intProps = new IntProps();
    IntProp intProp = new IntProp();
    intProp.setName("disk_failures");
    intProp.setValue(30);
    intProps.addIntProp(intProp);
    parameters1.setIntProps(intProps);
    diskParametrizedNode.setParameters(parameters1);
    request.addParameterizedNodes(diskParametrizedNode);
}

```

```

try {
    ExecuteTopologyQueryByNameWithParametersResponse
        response =
            getStub().executeTopologyQueryByNameWithParameters
                (request);
    TopologyMap map =
        getTopologyMapResult
            (response.getTopologyMap(), response.getChunkInfo());
} catch (RemoteException e) {
    //handle exception
} catch (UcmdbFaultException e) {
    //handle exception
}
}

/ // assume the follow query was defined at UCMDB
// Query Name: exampleQuery
// Query sketch:
//             Host
//             / \
//             ip Disk
// Query Parameters:
//   Host-
//     host_os (like)
//   Disk-
//     disk_failures (equal)

```

```

public void executeTopologyQueryWithParametersDemo() {
    ExecuteTopologyQueryWithParameters request =
        new ExecuteTopologyQueryWithParameters();
    CmdbContext cmdbContext = getContext();
    //set cmdbcontext
    request.setCmdbContext(cmdbContext);
    //set query definition
    String queryXml = "<xml that represents the query above>";
    request.setQueryXml(queryXml);
}

```

```

//set parameters
ParameterizedNode hostParameterizedNode =
    new ParameterizedNode();
hostParameterizedNode.setNodeLabel("Host");
CIProperties parameters = new CIProperties();
StrProps strProps = new StrProps();
StrProp strProp = new StrProp();
strProp.setName("host_os");
strProp.setValue("%2000%");
strProps.addStrProp(strProp);
parameters.setStrProps(strProps);
hostParameterizedNode.setParameters(parameters);
request.addParameterizedNodes(hostParameterizedNode);
ParameterizedNode diskParameterizedNode =
    new ParameterizedNode();
diskParameterizedNode.setNodeLabel("Disk");
CIProperties parameters1 = new CIProperties();
IntProps intProps = new IntProps();
IntProp intProp = new IntProp();
intProp.setName("disk_failures");
intProp.setValue(30);
intProps.addIntProp(intProp);
parameters1.setIntProps(intProps);
diskParameterizedNode.setParameters(parameters1);
request.addParameterizedNodes(diskParameterizedNode);
try {
    ExecuteTopologyQueryWithParametersResponse
    response = getStub().executeTopologyQueryWithParameters
        (request);
    TopologyMap map =
        getTopologyMapResult
            (response.getTopologyMap(), response.getChunkInfo());
} catch (RemoteException e) {
    //handle exception
} catch (UcmdbFaultException e) {
    //handle exception
}
}
}

```

```

public void getCI NeighboursDemo() {
    GetCI Neighbours request = new GetCI Neighbours();
    //set cmdbcontext
    CmdbContext cmdbContext = getContext();
    request.setCmdbContext(cmdbContext);
    // set CI id
    ID id = new ID();
    id.setBase("cmdbobjectidCIT1");
    request.setID(id);
    //set neighbour type
    request.setNeighbourType("neighbourType");
    //set Neighbours CIs properties to be retrieved
    TypedPropertiesCollection properties =
        new TypedPropertiesCollection();
    TypedProperties typedProperties1 = new TypedProperties();
    typedProperties1.setType("neighbourType");
    CustomTypedProperties customProperties1 =
        new CustomTypedProperties();
    PredefinedTypedProperties predefinedProperties1 =
        new PredefinedTypedProperties();
    QualifierProperties qualifierProperties =
        new QualifierProperties();
    qualifierProperties.addQualifierName("ID_ATTRIBUTE");
    predefinedProperties1.setQualifierProperties(qualifierProperties);
    customProperties1.setPredefinedTypedProperties
        (predefinedProperties1);
    typedProperties1.setProperties(customProperties1);
    properties.addTypedProperties(typedProperties1);
    request.setCIProperties(properties);

    TypedPropertiesCollection relationsProperties =
        new TypedPropertiesCollection();
    TypedProperties typedProperties2 = new TypedProperties();
    typedProperties2.setType("relationType");
    CustomTypedProperties customProperties2 =

```

```

        new CustomTypedProperties();
    PredefinedTypedProperties predefinedProperties2 =
        new PredefinedTypedProperties();
    SimpleTypedPredefinedProperty simplePredefinedProperty2 =
        new SimpleTypedPredefinedProperty();
    simplePredefinedProperty2.setName
        (SimpleTypedPredefinedProperty.nameEnum.CONCRETE);
    SimpleTypedPredefinedPropertyCollection
        simplePredefinedPropertyCollection2 =
        new SimpleTypedPredefinedPropertyCollection();
    simplePredefinedPropertyCollection2.
        addSimpleTypedPredefinedProperty
            (simplePredefinedProperty2);
    predefinedProperties2.
        setSimpleTypedPredefinedProperties
            (simplePredefinedPropertyCollection2);
    customProperties2.setPredefinedTypedProperties
        (predefinedProperties2);
    typedProperties2.setProperties(customProperties2);
    relationsProperties.addTypedProperties(typedProperties2);
    request.setRelationProperties(relationsProperties);

    try {
        GetCINeighboursResponse response =
            getStub().getCINeighbours(request);
        Topology topology = response.getTopology();
    } catch (RemoteException e) {
        //handle exception
    } catch (UcmdbFaultException e) {
        //handle exception
    }
}
}

```

//get Topology Map for chunked/non-chunked result

```

private TopologyMap getTopologyMapResult(TopologyMap topologyMap,
ChunkInfo chunkInfo) {
    if(chunkInfo.getNumberOfChunks() == 0) {
        return topologyMap;
    } else {
        topologyMap = new TopologyMap();
        for(int i=1 ; i <= chunkInfo.getNumberOfChunks() ; i++) {
            ChunkRequest chunkRequest = new ChunkRequest();
            chunkRequest.setChunkInfo(chunkInfo);
            chunkRequest.setChunkNumber(i);
            PullTopologyMapChunks req =
                new PullTopologyMapChunks();
            req.setChunkRequest(chunkRequest);
            req.setCmdbContext(getContext());
            PullTopologyMapChunksResponse res = null;
            try {
                res = getStub().pullTopologyMapChunks(req);
                TopologyMap map = res.getTopologyMap();
                topologyMap = mergeMaps(topologyMap, map);
            } catch (RemoteException e) {
                //handle exception
            } catch (UcmdbFaultException e) {
                //handle exception
            }
        }
    }
    return topologyMap;
}

```

```

private TopologyMap getTopologyMapResultFromCIs(CIs cis, ChunkInfo
chunkInfo) {
    TopologyMap topologyMap = new TopologyMap();
    if(chunkInfo.getNumberOfChunks() == 0) {
        CInode ciNode = new CInode();
        ciNode.setLabel("");
        ciNode.setCIs(cis);
    }
}

```

```

        CINodes ciNodes = new CINodes();
        ciNodes.addCINode(ciNode);
        topologyMap.setCINodes(ciNodes);
    } else {
        for(int i=1 ; i <= chunkInfo.getNumberOfChunks() ; i++) {
            ChunkRequest chunkRequest =
                new ChunkRequest();
            chunkRequest.setChunkInfo(chunkInfo);
            chunkRequest.setChunkNumber(i);
            PullTopologyMapChunks req =
                new PullTopologyMapChunks();
            req.setChunkRequest(chunkRequest);
            req.setCmdmdbContext(getContext());
            PullTopologyMapChunksResponse res = null;
            try {
                res = getStub().pullTopologyMapChunks(req);
            } catch (RemoteException e) {
                //handle exception
            } catch (UcmdmdbContextException e) {
                //handle exception
            }
            TopologyMap map = res.getTopologyMap();
            topologyMap = mergeMaps(topologyMap, map);
        }
        //release chunks
        ReleaseChunks req = new ReleaseChunks();
        req.setChunksKey(chunkInfo.getChunksKey());
        req.setCmdmdbContext(getContext());
        try {
            getStub().releaseChunks(req);
        } catch (RemoteException e) {
            //handle exception
        } catch (UcmdmdbContextException e) {
            //handle exception
        }
    }
    return topologyMap;
}
}

```



```

//=====
/* WARNING merge will be correct only if a each node is given
   a unique name. This applies to both CI and Relation nodes .*/
//=====
private TopologyMap mergeMaps(TopologyMap topologyMap, TopologyMap
newMap) {
    for(int i=0 ; i < newMap.getCINodes().sizeCINodeList() ; i++ ) {
        CINode ciNode = newMap.getCINodes().getCINode(i);
        boolean alreadyExist = false;
        if(topologyMap.getCINodes() == null) {
            topologyMap.setCINodes(new CINodes());
        }
        for(int j=0 ; j < topologyMap.getCINodes().sizeCINodeList() ; j++) {
            CINode ciNode2 = topologyMap.getCINodes().getCINode(j);
            if(ciNode2.getLabel().equals(ciNode.getLabel())){
                CIs cisTOAdd = ciNode.getCIs();
                CIs cis =
                    mergeCIsGroups
                    (topologyMap.getCINodes().getCINode(j).getCIs(),
                     cisTOAdd);
                topologyMap.getCINodes().getCINode(j).setCIs(cis);
                alreadyExist = true;
            }
        }
        if(!alreadyExist) {
            topologyMap.getCINodes().addCINode(ciNode);
        }
    }

    for(int i=0 ; i < newMap.getRelationNodes().sizeRelationNodeList() ; i++ ) {
        RelationNode relationNode =
            newMap.getRelationNodes().getRelationNode(i);
        boolean alreadyExist = false;
        if(topologyMap.getRelationNodes() == null) {
            topologyMap.setRelationNodes(new RelationNodes());
        }
    }
}

```

```

for(int j=0 ;
    j < topologyMap.getRelationNodes().sizeRelationNodeList() ;
    j++) {
    RelationNode relationNode2 =
        topologyMap.getRelationNodes().getRelationNode(j);
    if(relationNode2.getLabel().equals(relationNode.getLabel())){
        Relations relationsTOAdd = relationNode.getRelations();
        Relations relations =
            mergeRelationsGroups
            (topologyMap.getRelationNodes().
                getRelationNode(j).getRelations(),
                relationsTOAdd);
        topologyMap.getRelationNodes().
            getRelationNode(j).setRelations(relations);
        alreadyExist = true;
    }
}
if(!alreadyExist) {
    topologyMap.getRelationNodes().addRelationNode(relationNode);
}
}

return topologyMap;
}

```

```

private Relations mergeRelationsGroups(Relations relations1, Relations
relations2) {
    for(int i=0 ; i < relations2.sizeRelationList() ; i++) {
        relations1.addRelation(relations2.getRelation(i));
    }
    return relations2;
}

```

```

private Cls mergeClsGroups(Cls cis1, Cls cis2) {
    for(int i=0 ; i < cis2.sizeCIList() ; i++) {

```

```

        cis1.addCI(cis2.getCI(i));
    }
    return cis1;
}

}

```

## Update Example

```

package com.hp.ucmdb.demo;

import com.hp.ucmdb.generated.params.update.AddCIsAndRelations;
import com.hp.ucmdb.generated.params.update.AddCIsAndRelationsResponse;
import com.hp.ucmdb.generated.params.update.UpdateCIsAndRelations;
import com.hp.ucmdb.generated.params.update.DeleteCIsAndRelations;
import com.hp.ucmdb.generated.services.UcmdbFaultException;
import com.hp.ucmdb.generated.types.*;
import com.hp.ucmdb.generated.types.update.CIsAndRelationsUpdates;
import com.hp.ucmdb.generated.types.update.ClientIDToCmdbID;

import java.rmi.RemoteException;

public class UpdateDemo extends Demo{

    public void getAddCIsAndRelationsDemo() {
        AddCIsAndRelations request = new AddCIsAndRelations();
        request.setCmdbContext(getContext());
        request.setUpdateExisting(true);
        CIsAndRelationsUpdates updates = new CIsAndRelationsUpdates();
        CIs cis = new CIs();
        CI ci = new CI();
        ID id = new ID();
        id.setBase("temp1");
        id.setTemp(true);
        ci.setID(id);
    }
}

```

```

        ci.setType("host");
        CIProperties props = new CIProperties();
        StrProps strProps = new StrProps();
        StrProp strProp = new StrProp();
        strProp.setName("host_key");
        String value = "blabla";
        strProp.setValue(value);
        strProps.addStrProp(strProp);
        props.setStrProps(strProps);
        ci.setProps(props);
        cis.addCI(ci);
        updates.setCIsForUpdate(cis);
        request.setCIsAndRelationsUpdates(updates);
        try {
            AddCIsAndRelationsResponse response =
                getStub().addCIsAndRelations(request);
            for(int i = 0 ; i < response.sizeCreatedIDsMapList() ; i++) {
                ClientIDToCmdbID idsMap = response.getCreatedIDsMap(i);
                //do something
            }
        } catch (RemoteException e) {
            //handle exception
        } catch (UcmdbFaultException e) {
            //handle exception
        }
    }
}

```

```

public void getUpdateCIsAndRelationsDemo() {
    UpdateCIsAndRelations request = new UpdateCIsAndRelations();
    request.setCmdbContext(getContext());

    CIsAndRelationsUpdates updates =
        new CIsAndRelationsUpdates();
    CIs cis = new CIs();
    CI ci = new CI();
    ID id = new ID();
    id.setBase("temp1");
}

```

```

id.setTemp(true);
ci.setID(id);
ci.setType("host");
CIProperties props = new CIProperties();
StrProps strProps = new StrProps();

StrProp hostKeyProp = new StrProp();
hostKeyProp.setName("host_key");
String hostKeyValue = "blabla";
hostKeyProp.setValue(hostKeyValue);
strProps.addStrProp(hostKeyProp);

StrProp hostOSProp = new StrProp();
hostOSProp.setName("host_os");
String hostOSValue = "winXP";
hostOSProp.setValue(hostOSValue);
strProps.addStrProp(hostOSProp);

StrProp hostDNSProp = new StrProp();
hostDNSProp.setName("host_dnsname");
String hostDNSValue = "dnsname";
hostDNSProp.setValue(hostDNSValue);
strProps.addStrProp(hostDNSProp);

props.setStrProps(strProps);
ci.setProps(props);
cis.addCI(ci);
updates.setCIsForUpdate(cis);
request.setCIsAndRelationsUpdates(updates);
try {
    getStub().updateCIsAndRelations(request);
} catch (RemoteException e) {
    //handle exception
} catch (UcmdbFaultException e) {
    //handle exception
}
}

```

```

public void getDeleteCIsAndRelationsDemo() {
    DeleteCIsAndRelations request =
        new DeleteCIsAndRelations();
    request.setCmdbContext(getContext());
    CIsAndRelationsUpdates updates =
        new CIsAndRelationsUpdates();
    CIs cis = new CIs();
    CI ci = new CI();
    ID id = new ID();
    id.setBase("stam");
    id.setTemp(true);
    ci.setID(id);
    ci.setType("host");
    CIProperties props = new CIProperties();
    StrProps strProps = new StrProps();
    StrProp strProp1 = new StrProp();
    strProp1.setName("host_key");
    String value1 = "for_delete";
    strProp1.setValue(value1);
    strProps.addStrProp(strProp1);
    props.setStrProps(strProps);
    ci.setProps(props);
    cis.addCI(ci);
    updates.setCIsForUpdate(cis);
    request.setCIsAndRelationsUpdates(updates);
    try {
        getStub().deleteCIsAndRelations(request);
    } catch (RemoteException e) {
        //handle exception
    } catch (UcmdbFaultException e) {
        //handle exception
    }
}
}
}

```

**Class Model Example**

```

package com.hp.ucmdb.demo;

import com.hp.ucmdb.generated.params.classmodel.*;
import com.hp.ucmdb.generated.services.UcmdbFaultException;
import
com.hp.ucmdb.generated.types.classmodel.UcmdbClassModelHierarchy;
import com.hp.ucmdb.generated.types.classmodel.UcmdbClass;

import java.rmi.RemoteException;

public class ClassmodelDemo extends Demo{

    public void getClassAncestorsDemo() {
        GetClassAncestors request =
            new GetClassAncestors();
        request.setCmdbContext(getContext());
        request.setClassName("className");
        try {
            GetClassAncestorsResponse response =
                getStub().getClassAncestors(request);
            UcmdbClassModelHierarchy hierarchy =
                response.getClassHierarchy();
        } catch (RemoteException e) {
            //handle exception
        } catch (UcmdbFaultException e) {
            //handle exception
        }
    }

    public void getAllClassesHierarchyDemo() {
        GetAllClassesHierarchy request =
            new GetAllClassesHierarchy();
        request.setCmdbContext(getContext());
        try {
            GetAllClassesHierarchyResponse response =
                getStub().getAllClassesHierarchy(request);

```

```
        UcmdbClassModelHierarchy hierarchy =
            response.getClassesHierarchy();
    } catch (RemoteException e) {
        //handle exception
    } catch (UcmdbFaultException e) {
        //handle exception
    }
}

public void getCmdbClassDefinitionDemo() {
    GetCmdbClassDefinition request =
        new GetCmdbClassDefinition();
    request.setCmdbContext(getContext());
    request.setClassName("className");
    try {
        GetCmdbClassDefinitionResponse response =
            getStub().getCmdbClassDefinition(request);
        UcmdbClass ucmdbClass = response.getUcmdbClass();
    } catch (RemoteException e) {
        //handle exception
    } catch (UcmdbFaultException e) {
        //handle exception
    }
}
}
```

### **Impact Analysis Example**

```
package com.hp.ucmdb.demo;

import com.hp.ucmdb.generated.params.impact.*;
import com.hp.ucmdb.generated.services.UcmdbFaultException;
```



```

import com.hp.ucmdb.generated.types.*;
import com.hp.ucmdb.generated.types.impact.*;

import java.rmi.RemoteException;

/**
 * User: hbarkai
 * Date: Jul 17, 2007
 */
public class ImpactDemo extends Demo{

//Impact Rule Name : impactExample
//Impact Query:
//      Network
//      |
//      Host
//      |
//      IP
//Impact Action: network affect on ip ;severity 100% ; category: change
//
public void calculateImpactAndGetImpactPathDemo() {
    CalculateImpact request = new CalculateImpact();
    request.setCmdbContext(getContext());
    //set root cause ids
    IDs ids = new IDs();
    ID id = new ID();
    id.setBase("rootCauseCmdbID");
    ids.addID(id);
    request.setIDs(ids);
    //set impact category
    request.setImpactCategory("change");
    //set rule Names
    ImpactRuleNames impactRuleNames = new ImpactRuleNames();
    ImpactRuleName impactRuleName = new ImpactRuleName();
    impactRuleName.setBase("impactExample");
    impactRuleNames.addImpactRuleName(impactRuleName);
    request.setImpactRuleNames(impactRuleNames);
    //set severity
    request.setSeverity(100);
}
}

```

```

CalculateImpactResponse response =
    new CalculateImpactResponse();
try {
    response = getStub().calculateImpact(request);
} catch (RemoteException e) {
    //handle exception
} catch (UcmdbFaultException e) {
    //handle exception
}
Identifier identifier= response.getIdentifier();
Topology topology = response.getImpactTopology();
Relation relation = topology.getRelations().getRelation(0);
GetImpactPath request2 = new GetImpactPath();
//set cmdb context
request2.setCmdbContext(getContext());
//set impact identifier
request2.setIdentifier(identifier);
//set shallowRelation
ShallowRelation shallowRelation = new ShallowRelation();
shallowRelation.setID(relation.getID());
shallowRelation.setEnd1ID(relation.getEnd1ID());
shallowRelation.setEnd2ID(relation.getEnd2ID());
shallowRelation.setType(relation.getType());
request2.setRelation(shallowRelation);

try {
    GetImpactPathResponse response2 =
        getStub().getImpactPath(request2);
    ImpactTopology impactTopology =
        response2.getImpactPathTopology();
} catch (RemoteException e) {
    //To change body of catch statement
    // use File | Settings | File Templates.
    e.printStackTrace();
} catch (UcmdbFaultException e) {
    //To change body of catch statement
    // use File | Settings | File Templates.
    e.printStackTrace();
}

```

```

}

public void getImpactRulesByGroupName() {
    GetImpactRulesByGroupName request =
        new GetImpactRulesByGroupName();
    //set cmdb context
    request.setCmdbContext(getContext());
    //set group names list
    request.addRuleGroupNameFilter("groupName1");
    request.addRuleGroupNameFilter("groupName2");
    try {
        GetImpactRulesByGroupNameResponse response =
            getStub().getImpactRulesByGroupName(request);
        ImpactRules impactRules = response.getImpactRules();
    } catch (RemoteException e) {
        //handle exception
    } catch (UcmdbFaultException e) {
        //handle exception
    }
}

}

public void getImpactRulesByNamePrefix() {
    GetImpactRulesByNamePrefix request =
        new GetImpactRulesByNamePrefix();
    //set cmdb context
    request.setCmdbContext(getContext());
    //set prefixes list
    request.addRuleNamePrefixFilter("prefix1");
    try {
        GetImpactRulesByNamePrefixResponse response =
            getStub().getImpactRulesByNamePrefix(request);
        ImpactRules impactRules = response.getImpactRules();
    } catch (RemoteException e) {
        //handle exception
    } catch (UcmdbFaultException e) {

```

```
        //handle exception
    }
}
```

## UCMDB General Parameters

This section describes the most common parameters of the service's methods. For details, refer to the schema documentation.

This section includes the following topics:

- ▶ “CmdbContext” on page 388
- ▶ “ID” on page 388
- ▶ “Key Attributes” on page 389
- ▶ “ID Types” on page 389
- ▶ “CIProperties” on page 390
- ▶ “Type Name” on page 390
- ▶ “Configuration Item (CI)” on page 390
- ▶ “Relation” on page 391

### **CmdbContext**

All UCMDB API service invocations require a `CmdbContext` argument. `CmdbContext` is a `callerApplication` string that identifies the application that invokes the service. `CmdbContext` is used for logging and troubleshooting.

### **ID**

Every CI and Relation has an ID field. It consists of a case-sensitive ID string and an optional temp flag, indicating whether the ID is temporary.

## Key Attributes

For identifying a CI or Relation in some contexts, key attributes can be used in place of a UCMDB ID. Key attributes are those attributes with the ID\_ATTRIBUTE set in the class definition.

In the user interface, the key attributes have a key icon next to them in the list of Configuration Item Type attributes in the user interface. For details, see “Add/Edit Attribute Dialog Box” in *Model Management*. For information about identifying the key attributes from within the API client application, see “getCmdmClassDefinition” on page 356.

## ID Types

An ID element can contain a real ID, a temporary ID, or can be empty.

A real ID is a string assigned by the UCMDB that identifies an entity in the database. A temporary ID can be any string that is unique in the current request. An empty ID means no value is assigned.

A temporary ID can be assigned by the client and often represents the ID of the CI as stored by the client. It does not necessarily represent an entity already created in the UCMDB. When a temporary ID is passed by the client, if the UCMDB can identify an existing data configuration item using the CI key properties, that CI is used as appropriate for the context as though it had been identified with a real ID.

The real ID of a CI is calculated by the UCMDB based on a combination of the CI's type and key properties. The real ID of a Relation is based on the relations's type, the IDs of the two CIs that are part of the relationship, and the relation's key properties. Therefore, key attribute values must be set during CI or Relation creation. If the key properties values are not specified when creating a CI, there are two possibilities. If the CIT has the RANDOM\_GENERATED\_ID qualifier, the server generates a unique ID. If not, an exception is thrown.

For details, see *CI Attribute Customization*.

## **CIProperties**

A CIProperties element is composed of collections, each containing a sequence of name-value elements that specify properties of the type indicated by the collection name. None of the collections are required, so the CIProperties element can contain any combination of collections.

CIProperties are used by CI and Relation elements. For details, see “Configuration Item (CI)” on page 390 and “Relation” on page 391.

The properties collections are:

- dateProps - collection of DateProp elements
- doubleProps - collection of DoubleProp elements
- floatProps - collection of FloatProp elements
- intListProps - collection of intListProp elements
- intProps - collection of IntProp elements
- strProps - collection of StrProp elements
- strListProps - collection of StrListProp elements
- longProps - collection of LongProp elements
- bytesProps - collection of BytesProp elements
- xmlProps - collection of XmlProp elements

## **Type Name**

The type name is the class name of a configuration item type or relation type. The type name is used in code to refer to the class. It should not be confused with the display name, which is seen on the user interface where the class is mentioned, but which is meaningless in code.

## **Configuration Item (CI)**

A CI element is composed of an ID, a type, and a props collection.

When using HP UCMDB Module Update Methods to update a CI, the ID element can contain a real UCMDB ID or a client-assigned temporary ID. If a temporary ID is used, set the temp flag to true. When deleting an item, the ID can be empty. HP UCMDB Module Query Methods take real IDs as input parameters and return real IDs in the query results.

The type can be any type name defined in the CI Type Manager. For details, see “CI Type Manager User Interface” in *Model Management*.

The props element is a CIProperties collection. For details, see “CIProperties” on page 390.

## Relation

A Relation is an entity that links two configuration items. A Relation element is composed of an ID, a type, the identifiers of the two items being linked (end1ID and end2ID), and a props collection.

When using HP UCMDB Module Update Methods to update a Relation, the value of the Relation’s ID can be a real UCMDB ID or a temporary ID. When deleting an item, the ID can be empty. HP UCMDB Module Query Methods take real IDs as input parameters and return real IDs in the query results.

The relation type is the Type Name of the HP UCMDB class from which the relation is instantiated. The type can be any of the relation types defined in the UCMDB. For further information on classes or types, see “Query the HP UCMDB Module Class Model” on page 355.

For details, see “CI Type Manager User Interface” in *Model Management*.

The two relation end IDs must not be empty IDs because they are used to create the ID of the current relation. However, they both can have temporary IDs assigned to them by the client.

The props element is a CIProperties collection. For details, see “CIProperties” on page 390.

## UCMDB Output Parameters

This section describes the most common output parameters of the service methods. For details, refer to the schema documentation.

This section includes the following topics:

- “CIs” on page 392
- “ShallowRelation” on page 392
- “Topology” on page 392
- “CINode” on page 392
- “RelationNode” on page 393
- “TopologyMap” on page 393
- “ChunkInfo” on page 393

### **CIs**

CIs is a collection of CI elements.

### **ShallowRelation**

A ShallowRelation is an entity that links two configuration items, composed of an ID, a type, and the identifiers of the two items being linked (`end1ID` and `end2ID`). The relation type is the `Type Name` of the UCMDB class from which the relation is instantiated. The type can be any of the relation types defined in the UCMDB.

### **Topology**

Topology is a graph of CI elements and relations. A Topology consists of a CIs collection and a Relations collection containing one or more Relation elements.

### **CINode**

CINode is composed of a CIs collection with a label. The label in the CINode is the label defined in the node of the TQL used in the query.



## RelationNode

RelationNode is a set of Relations collections with a label. The label in the RelationNode is the label defined in the node of the TQL used in the query.

## TopologyMap

TopologyMap is the output of a query calculation that matches a TQL query. The labels in the TopologyMap are the node labels defined in the TQL used in the query.

The data of TopologyMap is returned in the following form:

- ▶ CInodes. This is one or more CInode (see “CInode” on page 392).
- ▶ relationNodes. This is one or more RelationNode (see “RelationNode” on page 393).

The labels in these two structures order the lists of configuration items and relations.

## ChunkInfo

When a query returns a large amount of data, the server stores the data, divided into segments called chunks. The information the client uses to retrieve the chunked data is in the ChunkInfo structure returned by the query. ChunkInfo is composed of the numberOfChunks that must be retrieved and the chunksKey. The chunksKey is a unique identifier of the data on the server for this specific query invocation.

For more information, see “Processing Large Responses” on page 334.



# 7

---

## Working with the Dashboard API

This chapter describes how to retrieve a list of all available views in an HP Business Availability Center system through a URL-based query to the database.

**This chapter includes:**

- Building Queries on page 395
- Query Examples on page 398

### Building Queries

You use the Dashboard API to query the database and return a list of views in XML format.

---

**Tip:** You can use XSLT to convert the XML output into any other format (commonly text or HTML). For example, using basic XSLT transformations, you can produce HTML reports that are formatted to fit on mobile devices. These reports can be served via a mobile portal to display critical Business Availability Center views on users' mobile phones.

---

## Query Syntax

The basic syntax of the query is as follows:

```
http://<Gateway Server>/topaz/bam/
BAMOpenApi?customerID=<customer ID>&userName=<user
name>&password=<password>&command=<command parameter>
```

Depending on the **command** parameter defined, additional parameters may also be included.

## Main Parameters Used in the Query

The table below lists the parameters that must be defined in the query.

Parameter	Description
customerID	HP Business Availability Center customers should specify <b>1</b> . HP Software-as-a-Service customers should specify their unique customer ID.
userName	Specify a user name defined in HP Business Availability Center. The query does not encrypt the login credentials.
password	Specify the password for the user name provided. The query does not encrypt the login credentials.
command	Specify one of the following values: <b>getViews</b> – Specify to retrieve all views from the CMDB. No other parameters are required. <b>getNode</b> s – Specify to retrieve all child nodes of a specified view (you must also specify the view for which to retrieve child nodes in the <b>viewName</b> parameter); if using this command parameter you can also set the following parameters: <b>showTooltip</b> , <b>depth</b> , <b>layout</b> , <b>xsltURL</b> , <b>responseContentType</b>
viewName	If the <b>getNode</b> s command parameter is defined, include this parameter in the query and specify the view to retrieve. You can set the value to <b>ticker_all_views</b> to retrieve all views and their nodes.

Parameter	Description
showTooltip	If the <b>getNode</b> s command parameter is defined, you can include this parameter in the query to specify whether to display Dashboard's KPI tooltip data, either <b>true</b> to display data or <b>false</b> to not. The default value is <b>false</b> .
depth	If the <b>getNode</b> s command parameter is defined, you can include this parameter in the query to specify the number of levels in the view to display. The default value is <b>1</b> .
layout	If the <b>getNode</b> s command parameter is defined, you can include this parameter in the query to specify the layout for the query results, either <b>hierarchical</b> or <b>flat</b> . In flat mode all nodes are retrieved in a flat list, and in hierarchical mode nodes are retrieved in the same hierarchy as in the view. The default value is <b>flat</b> .
xsltURL	If the <b>getNode</b> s command parameter is defined, you can include this parameter in the query to specify a URL to an .xslt file that transforms the .xml-format result of the query.
responseContentType	If the <b>getNode</b> s command parameter is defined, and the <b>xsltURL</b> parameter is included in the query, you can include this parameter in the query to specify the response MIME type.

## Query Examples

Below are examples of queries and the data they return.

- The query below returns a flat list of all views in the CMDB.

**`http://myserver/topaz/bam/`**

**`BAMOpenApi?customerId=1&userName=admin&password=admin&command=getViews`**

- The query below returns a hierarchical tree showing KPI status and tooltip information for the Service Measurements view, to a depth of three child nodes.

**`http://myserver/topaz/bam/`**

**`BAMOpenApi?customerId=1&userName=admin&password=admin&command=getNodes&viewName=Service%20Measurements&showTooltip=true&depth=3&layout=hierarchical`**

# Part V

---

## EMS Integrations





# 8

---

## Enterprise Management Systems Integration

This chapter describes the Enterprise Management Systems integration.

### **This chapter includes:**

#### **Concepts**

- ▶ Enterprise Management Systems and the EMS Integrations Application Overview on page 402
- ▶ Understanding the Application<-->Host or Host Integration Adapters on page 403
- ▶ Reconciliation of Hosts on page 405

#### **Tasks**

- ▶ Integrate Data from Third-Party Sources (EMS Data) into HP Business Availability Center on page 407

#### **Reference**

- ▶ EMS User Interface on page 414

## Enterprise Management Systems and the EMS Integrations Application Overview

HP Business Availability Center has the ability to integrate with existing EMS (Enterprise Management Systems) software and provides the capability to build new integrations or to customize out-of-the-box integrations (for example: HP OVO, HP ServiceCenter, or Netscout nGenius).

SiteScope Integration Monitors integrate measurements, open incidents, alerts, and events generated by Enterprise Management Systems software into HP Business Availability Center reports. Enterprise Management Systems integrations can integrate alerts generated by HP Business Availability Center, Dashboard, and Service Level Management into your Enterprise Management Systems program.

The EMS Integrations application helps you customize the Integration Monitor configuration files to correctly map the data Integration Monitors collect to a format recognizable by HP Business Availability Center, provides out-of-the-box integrations, and enriches your business views.

The EMS Integrations application enables you to sketch a CIT relationship map of the integration you are creating to help you formulate the KPI assignment rules that are described below.

You can directly access the System Availability Management Administration through a window in the EMS Integrations application, where you can access a SiteScope and deploy integration monitors to collect performance and availability data from your EMS system. This data, which can represent CPU, disk space, or other information, provides the global status of the EMS Monitor CI.

You can create or customize a KPI assignment rule for each integration CI type in the CIT relationship map you sketched previously. An assignment rule includes a condition and a task. The condition describes specific characteristics of a CI. The task describes the context menus, KPIs, rules, rule parameters, and selectors that are to be assigned automatically to the CI when the condition occurs, if the assignment is running. For details, see “Assignment Rules Mechanism and KPI Propagation” in *Using Dashboard*.

You can then display the view that is created by the integration.

An EMS integration is used to display, in Dashboard, an overview of data from other applications. It is not a run-time solution where you can see events and errors as they occur.

---

**Note:** To change the logic, use one of the following options:

- ▶ For a specific CI in a specific view, modify the logic for that CI in **Admin > Dashboard > KPIs**.
  - ▶ For all the appropriate instances of a CI, retroactively, modify the logic in **Admin > EMS Integrations**. This change is valid for future instances of the CI.
- 

## Understanding the Application<-->Host or Host Integration Adapters

This section describes the main concepts of the Application <--> Host or Host integration adapter.

The out-of-the-box Application <--> Host and Host integration adapters use out-of-the-box Jython scripts to create the appropriate topology.

This section includes the following topics:

- ▶ “Application <--> Host Integration Adapter” on page 404
- ▶ “Host Integration Adapter” on page 404
- ▶ “EMS Monitor CI” on page 405

## Application <--> Host Integration Adapter

The integration adapter adds the **EMS Monitor** CI to the **Application** CI, assigns the **Application** KPI to the **Application** CI, adds the **Host** CI to the topology, assigns the **System** KPI to the **Host** CI. It also adds the **Clear Events** context menu item that enables you to clear an event. All the host information (for example: CPU or disk space) available from the sample provides status information to the EMS Monitor CI.

---

**Note:** The integration adapter automatically runs on all existing CIs and applies to those CIs the topology changes described above.

---

The status of the Host CI in that topology is grey. To display the status of the Host CI, set the flag to Host in Jython. By default the flag is set to Application. For details, see “Topology Settings” in *Using System Availability Management*.

For details about the System KPI, see “System” in *CI Attribute Customization*.

For details about the Clear Events context menu item, see “Show Events” in *CI Attribute Customization*.

## Host Integration Adapter

The Host integration adapter adds the **EMS Monitor** CI to the **Host** CI in the topology, and adds the **System** KPI to the **Host** CI. It also adds the **Clear Events** context menu item that enables you to clear an event. All the host information (for example, CPU or disk space), available from the sample provides status information to the Host CI through the EMS Monitor CI. The status of the Host CI represents the global status of the host.

For details about the System KPI, see “System” in *CI Attribute Customization*.

For details about the Clear Events context menu item, see “Show Events” in *CI Attribute Customization*.

## EMS Monitor CI

When running the EMS integration generally only one **EMS Monitor CI** is created per Host CI. In the process of the integration, if there is a problem with identifying the DNS name of the host while creating the monitor, more than one **EMS Monitor CI** can be created for the host. (For example, one monitor CI has the IP address and the other monitor CI has the DNS name.)

When reporting status to the Host CI, only one monitor CI receives the data and passes status onto the Host CI. The other CIs remain empty and eventually disappear due to the Aging Mechanism. For details, see “Removing Out of Date CIs Using the Aging Mechanism” in *Model Management*.

---

**Note:** The integration adapter automatically run on all existing CIs and applies to those CIs the topology changes described above.

---

## Reconciliation of Hosts

The CMDB reconciliation service is used to reconcile incomplete hosts with complete hosts. Incomplete hosts are created in the CMDB after they are discovered by the discovery process (from Discovery and Dependency Mapping) or by SiteScope (the **Enable host topology reporting** option is set by default). Complete hosts are created in the CMDB after they are discovered by the discovery process.

A **complete host** is a host with the **complete** flag set. It is identified by its MAC address.

The CMDB performs the following actions:

- 1 Copies each **Depends on**, **System monitor**, or **Monitored by** link that links to an incomplete Host CI to the corresponding complete Host CI (linked to the same IP), in the CMDB. The default KPIs attached to the incomplete Host CIs are also copied to the complete Host CI. If an incomplete Host CI is part of an SLA, the SLA is copied to the corresponding complete Host CI.

**2** Erases the incomplete Host CI from the CMDB.

The CMDB\_ID\_MAPPING table in the Management database lists the pairs of the CMDB IDs of incomplete hosts to the CMDB IDs of the complete hosts that were processed by the service.

**Limitations**

The limitations of the reconciliation of hosts are as follows:

- ▶ After the reconciliation of hosts takes place, the historical reports of reconciled Host CIs display data at the level of the complete Host CI, only from the date and time when the reconciliation took place. Host CIs, which do not need reconciliation, continue to display data.
- ▶ To restore data at the level of the Host CI, you can run an SLA recalculation taking into account the recalculation limitations. For details, see “Recalculation for Agreements” in *Using Service Level Management*.
- ▶ Manually modified properties of incomplete Host CIs are not copied to the complete Host CI.

## Integrate Data from Third-Party Sources (EMS Data) into HP Business Availability Center

This section describes the processes for integrating data from third-party sources (EMS data) into HP Business Availability Center, and gives examples.

The flowchart below describes the process required to integrate data from third-party enterprise management systems (EMS data) into HP Business Availability Center using SiteScope Integration Monitors.

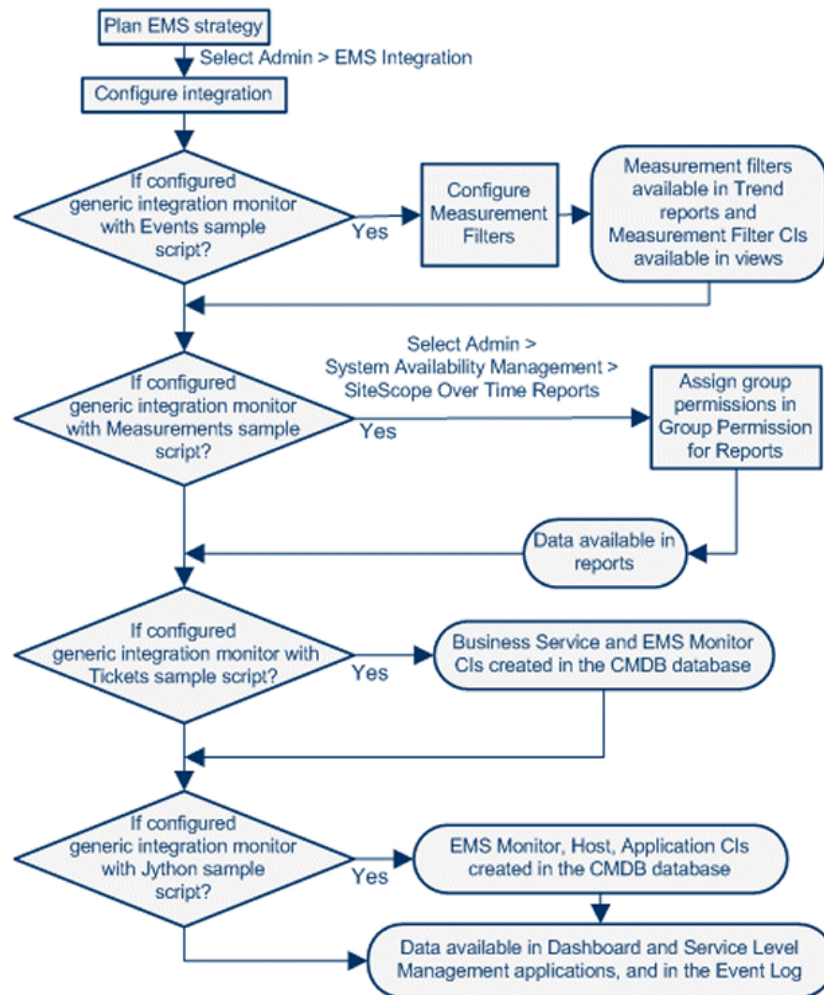

This task includes the following steps:

- “Plan EMS Strategy” on page 408
- “Configure the Integration” on page 408
- “Display Data in the Event Log” on page 414
- “Configure Measurement Filters” on page 414
- “Assign Group Permissions” on page 414

## 1 Plan EMS Strategy

Review the Integration Monitor types. Consider the type of information you want to see in HP Business Availability Center from your EMS system. Determine whether one of the specific Integration Monitors meets your organization’s needs or whether a generic Integration Monitor (Technology Log File, Database, SNMP Trap, Web Service) is required.

Review the Event and Metrics samples and fields to understand how the incoming EMS metadata maps to HP Business Availability Center metadata.

For more information, see “Working with SiteScope Integration Monitors” in *Using System Availability Management*.

## 2 Configure the Integration

In the EMS Integrations application, configure the integration as follows:

- Sketch a CIT relationship map of the integration you are creating to help you formulate the KPI assignment rules that are described below and to understand which topology to create.
- Open the System Availability Management Administration window where you can access a SiteScope and deploy integration monitors to collect performance and availability data from your EMS system. For details, see “Working with SiteScope Integration Monitors” in *Using System Availability Management*.



- ▶ Create or customize a KPI assignment rule for each integration CI type in the CIT relationship map you sketched previously. An assignment rule includes a condition and a task. The condition describes specific characteristics of a CI. The task describes the KPIs, rules, and context menus that are to be assigned automatically to the CI when the condition occurs, if the assignment is running. For details, see “Configure a KPI Assignment Rule” in *Using Dashboard*.
- ▶ You can then display the view that is created by the integration.

The view displays the following:

- ▶ EMS Monitor CIs that were created by the EMS integration
- ▶ CIs that were created by the EMS integration and that have a relationship to the above EMS Monitor CIs.
- ▶ All hosts with a relationship to either of the CIs mentioned above.

---

**Note:** Do not edit or change the view – parts of the view are hidden in Dashboard. To view the integration topology in a different way, create another view.

---

The HP OVO and HP ServiceCenter integrations are out-of-the-box integrations that enable the user to view HP OVO and HP ServiceCenter data in HP Business Availability Center.

### **Example – Create an Application <--> Host Integration**

To create an Application <--> Host integration:

- a** Integrate HP Business Availability Center and the appropriate SiteScope. To specify the name of the host, select **Admin > System Availability Management**. Right-click **Summary** and select **New SiteScope**. In Main Settings, enter the name of the host in the **Display Name** and **Host Name** boxes.



- b** Select **Admin > EMS Integrations**, and click to open the Add Integration dialog box. Enter **emsTest** in the **Data Source** box, select **Application <--> Host** in the **Type** list, and enter a description in the **Description** box.

- c** In the Integrations Implementation Test area, click **1. Define the CIT relationships map** to display the sketch of relationships for a typical Application <--> Host integration.

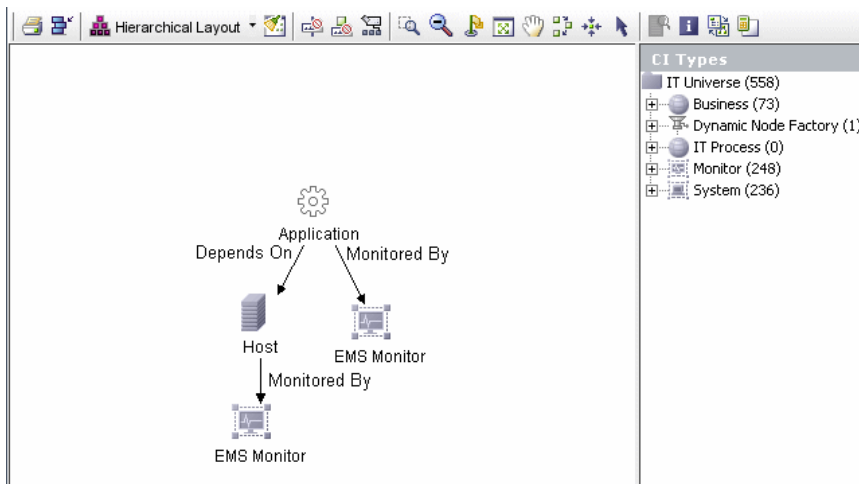

- d** In the Integrations Implementation Test area, click **2. Retrieve data from EMS system using BAC's System Availability Management Administration (SAM Admin)** to open the Summary page of System Availability Management. In that page, perform the following:

- Right-click the SiteScope monitor you set up previously.
- Create a new group EMS.
- Under new monitor, select the Integration Monitor and the Log File Integration.
- Enter content match and the log file path name.
- Click **Load File**.
- Click **Test Script**.

- In the Topology Settings, select **Host-Application, Load, Test Script**, and click **OK**.

For additional information about the monitor, see “Technology Log File Integration Monitor” in *System Availability Management*.

- e In the Integrations Implementation Test area, under **3. Define the data assignments rules**, select the **Host Monitor CIs** assignment rule and then click **Start** to run the assignment rule. Do the same for the **Application Monitor CIs** assignment rule.
- f In the Integrations Implementation Test area, click **4. View the integration results**, to display the topology of the default view named after the name you gave in the **Data Source** box in the steps above.

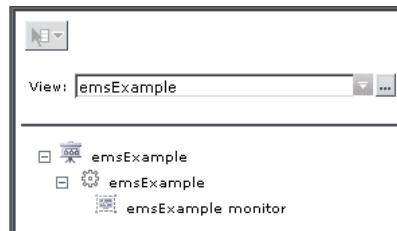

- g Select **Applications > Dashboard**, select the Console tab, and click **emsExample**. The topology of the new view is displayed with data.



The integration is complete.

### Example – Create a Technology Log File Integration Monitor

To create the Technology Log File Integration monitor, access SiteScope and create a new monitor. Select the Integration Monitor category, and click Technology Log File Integration to open the New Technology Log File Integration monitor page. Enter the following values:

- In **Content Match**, use the following example:

```
/(.*)/(.*)/(.*)/(.*)/(.*)/(.*)/
```

- In **Sample type**, use the following example:

```
8,event8,1,espresso,emsLog,app
8,event8,1,espresso,emsLog,app
```

- In **Fields mapping**, enter the following example:

```
#####
#   EMS Integrations event config file           #
# Use this file to send events to Business Availability Center   #
#                                           #
# Refer to "Integration Monitor Configuration Files" in SiteScope #
# documentation for more information.           #
#####

[$DEFAULT_PARAMETERS$]
#####
# NOTE: the following parameters are mandatory #
#####
# Time stamp in seconds since Jan 1st 1970 format.
# Use time() to get the sitescope host time or str_to_seconds() to read a value from the
input event
time_stamp:DOUBLE=time()
# Severity of event. Possible values are:
# SEVERITY_UNKNOWN , SEVERITY_INFORMATIONAL , SEVERITY_WARNING ,
SEVERITY_MINOR , SEVERITY_MAJOR, SEVERITY_CRITICAL
severity:INT=$group2

# The name of the host / device that caused this event. If the name cannot be
determined an IP address can be used instead
target_name=$group3
# Event status or type (e.g "OPEN", "ASSIGNED", "CLOSED")
status="OPEN"

# Subject of event (e.g. CPU , SAP application, Hard Disk ). Middle / High level of
hierarchy describing the event source
# The hierarchy describing an event is in the following format:
# monitor_group (optional) --> object (optional) --> subject --> instance
# More levels can be added above monitor_group by using logical_group, and attr1 - 5
subject=$group4

# Instance of subject that generated the event (e.g "D:\"). The lowest level of hierarchy
describing the event source.
# See Subject explanation above.
instance=$group4
```

```

# Event description. Up to 2000 characters.
description=$group1

# Application / Software from which this event was collected
data_source=$group4
#####
# NOTE: The following parameters are optional.  #
# Remove comments from entries you wish to use  #
#####
# IP of the host \ device that caused this event
#target_ip=
# Object of this event (e.g. OS, Network, etc). optional level in the hierarchy describing
the event source

# See Subject explanation above.
#object=
# A unique identifier for this event
event_id=$group0
# For logical grouping
# See Subject explanation above.
#logical_group=
# Monitor group that reported this event. optional level in the hierarchy describing the
event source
# See Subject explanation above.
#monitor_group=

# Severity name in integrated system terminology
#orig_severity_name=
# Operator who acknowledged this event
#acknowledged_by=
# Operator who owns this event
#owner=
# Use with any numeric values you wish to send to Business Availability Center
#value:DOUBLE=

# Additional attributes 1..5
attr1=$group5
#attr2=
#attr3=
#attr4=
# For long string values up to 2000 use attr5
#attr5=
[allRecords]
$MATCH=true
$ACTION=TOPAZ_BUS_POST(event)

```

- ▶ In **Topology Settings**, select the Host--Applications topology.

Test the script by clicking **Test Script** to view the expected results of the monitor.

For details, see “Technology Log File Integration Monitor” in *System Availability Management*.

### 3 Display Data in the Event Log

After monitors are defined in System Availability Management Administration, data can be seen in the Event Log and in Dashboard.

Depending on whether you configure Integration Monitors that use the metrics data template or Integration Monitors that use the event data template, you proceed differently to enable the data to be viewed in HP Business Availability Center.

### 4 Configure Measurement Filters

If you configure a generic integration monitor with an Events sample script, you must configure measurement filters to enable viewing Integration Monitor event data in trend reports. In addition, each measurement filter you create gets added to the UDX Measurement Filters view as a CI. These CIs can be added to Dashboard views and SLAs. For more information, see “Working with Measurement Filters” in *Platform Administration*.

### 5 Assign Group Permissions

If you configure a generic integration monitor with a Measurements sample script, you must assign for each defined user, permissions to view SiteScope groups and their subgroups in System Availability Management reports and custom reports. For more information, see “Permissions Overview” in *Platform Administration*.

## EMS User Interface

**This section describes:**

- ▶ Add Integration Dialog Box on page 415

- Edit Integration Dialog Box on page 417
- CIT Relationships Map Dialog Box on page 421
- Define Assignment Configuration Dialog Box on page 422
- EMS Integrations Admin Page on page 424

## Add Integration Dialog Box

<b>Description</b>	Enables you to create a new integration. <b>To access:</b> Click  in the EMS Integrations page.
<b>Included in Tasks</b>	“Integrate Data from Third-Party Sources (EMS Data) into HP Business Availability Center” on page 407
<b>Useful Links</b>	“Enterprise Management Systems and the EMS Integrations Application Overview” on page 402

The initial dialog box includes the following elements:

GUI Element (A-Z)	Description
<b>Data Source</b>	Enter the name of the integration data source when you create a custom integration. <b>Note:</b> The same data source must be used in the mapping fields and in the topology section in the integration monitor. For details, see 2. Retrieve data from EMS system using BAC’s System Availability Management Administration (SAM Admin) in “Edit Integration Dialog Box” on page 417. <b>Note:</b> The sample must be part of the same data source.
<b>Description</b>	A description of the integration you are creating. The description is displayed in the EMS Integrations page.
<b>OK</b>	Click to open the Edit Integration dialog box.

GUI Element (A-Z)	Description
<p><b>Type</b></p>	<p>Select the type of integration you want to create. Select:</p> <ul style="list-style-type: none"> <li>▶ <b>Custom.</b> To create a custom integration.</li> <li>▶ <b>Host.</b> To create a host integration that adds hosts or reconciles the new hosts with existing hosts and sends data into the hosts. For details, see “Understanding the Application&lt;--&gt;Host or Host Integration Adapters” on page 403.</li> <li>▶ <b>Application &lt;--&gt; Host.</b> To create an application to host integration. For details, see “Reconciliation of Hosts” on page 405. When you select <b>Host</b> or <b>Application &lt;--&gt; Host</b>, the integration automatically runs the assignment rules on all the existing CIs.</li> <li>▶ <b>ServiceCenter.</b> To create a business service connected to EMS monitor entities. For details, see “Understanding the Application&lt;--&gt;Host or Host Integration Adapters” on page 403.</li> <li>▶ <b>HP Business Process Insight.</b> To integrate HP Business Process Insight data into HP Business Availability Center. For details, see “Understanding the Application&lt;--&gt;Host or Host Integration Adapters” on page 403.</li> <li>▶ <b>Netscout.</b> To integrate Netscout data into HP Business Availability Center. For details, see “NetScout Integration Overview” on page 461.</li> </ul>



## Edit Integration Dialog Box

<b>Description</b>	Enables you to edit an existing integration or to enter the details of a new integration. <b>To access:</b> In the EMS Integrations page, select an integration and click  .
<b>Important Information</b>	Complete each step of the procedure before starting on the next one. Do not remove the data source when editing an integration. It is recommended to work as much as possible with the out-of-the-box solutions: HP ServiceCenter, HP OVO, HP Business Process Insight, Host, or Application<-->Host.
<b>Included in Tasks</b>	“Integrate Data from Third-Party Sources (EMS Data) into HP Business Availability Center” on page 407
<b>Useful Links</b>	“Enterprise Management Systems and the EMS Integrations Application Overview” on page 402

### General Area

The following elements are included (unlabeled GUI elements are shown in angle brackets>):

GUI Element (A-Z)	Description
HP OVO Host	<b>For OVO integration only.</b> The name of the HP OVO host. This field is not mandatory. This information is used to access the HP OVO application using the OVO Drill Down context menu option. For details, see “OVO Drill Down” in <i>CI Attribute Customization</i> . <b>Limitation:</b> See “OVO Drill Down Event” in <i>CI Attribute Customization</i> .



GUI Element (A-Z)	Description
<p><b>HP OVO User Name</b></p>	<p><b>For OVO integration only.</b></p> <p>The name of the HP OVO user.</p> <p>This field is not mandatory.</p> <p>This information is used to access the HP OVO application using the OVO Drill Down context menu option. For details, see “OVO Drill Down” in <i>CI Attribute Customization</i>.</p> <p><b>Limitation:</b> See “OVO Drill Down Event” in <i>CI Attribute Customization</i>.</p>
<p><b>HP OVO User Password</b></p>	<p><b>For OVO integration only.</b></p> <p>This field is not mandatory.</p> <p>The password of the HP OVO user.</p> <p>This information is used to access the HP OVO application using the OVO Drill Down context menu option. For details, see “OVO Drill Down” in <i>CI Attribute Customization</i>.</p> <p><b>Limitation:</b> See “OVO Drill Down Event” in <i>CI Attribute Customization</i>.</p>





GUI Element (A-Z)	Description
Switch to Advanced Mode	<p><b>For OVO integration only.</b></p> <p>Click to add the Network and Security KPIs enrichment to the existing Application Monitor CIs and Host Monitor CIs data assignment rules.</p> <p>The enrichment rules cause the <b>Network</b> and <b>Security</b> KPIs to be automatically attached to all OVO CIs (except to the EMS Monitor CIs directly under the Application CIs) in the Dashboard views in addition to the <b>Application</b>, and <b>System</b> KPIs. For details, see “Network” or “Security” in <i>CI Attribute Customization</i>.</p> <p>Clicking the button has no impact in Service Level Management: <b>Network</b> and <b>Security</b> KPIs are not automatically attached to the OVO CIs when the CIs are added to an SLA in Service Level Management. For information on attaching these KPIs, see “CIs and KPIs for HP OVO” on page 426.</p> <p><b>Note:</b> If you change mode after the integration topology was created, it is recommended to select the assignment rules and to re-run them, with the <b>Run on existing CIs</b> option selected, in order to re-attach the proper KPIs and rules to the existing CI. For details, see “Define Assignment Configuration Dialog Box” on page 422.</p>

## Integration Implementation Steps Area

Description	
	Enables you to specify and implement the integration.

The following elements are included (unlabeled GUI elements are shown in angle brackets>):

GUI Element (A-Z)	Description
	Click to create a data assignment rule in the Define Assignment Configuration dialog box.
	Select a data assignment rule and click to edit the rule in the Define Assignment Configuration dialog box.

GUI Element (A-Z)	Description
	Select a data assignment rule and click to delete.
	Not applicable.
	Select a data assignment rule and click to synchronize the selected rule.
	Select a data assignment rule and click to start the assignment of the rule to existing and new CIs.
	Select a data assignment rule and click to stop the assignment of the rule.
<p><b>1. Define the CIT relationships map</b></p>	<p>Click to open the CIT relationship map dialog box where you can sketch the relationship map for the integration. This schema is useful to help you draw which CI types are created and where the EMS monitors are located so assignment rules can run on those EMS monitors. For details, see “CIT Relationships Map Dialog Box” on page 421.</p>
<p><b>2. Retrieve data from EMS system using BAC’s System Availability Management Administration (SAM Admin)</b></p>	<p>Click to open the System Availability Management application. For details, see “System Availability Management Administration” in <i>Using System Availability Management</i>.</p> <p>Select from where the data is extracted (for example: Database) and which type of data (measurements, events or open incidents) is needed.</p> <p>To set up the HP OVO Event Monitor, see “HP OVO Event Monitor” in <i>Using System Availability Management</i>.</p> <p>To set up the HP Service Center Monitor, see “HP ServiceCenter Monitor” in <i>Using System Availability Management</i>.</p> <p><b>Limitation:</b> If you have previously defined a SiteScope using this option and you reopen System Availability Management, the application does not display the SiteScope you have previously defined.</p>

GUI Element (A-Z)	Description
<b>3. Define the data assignments rules</b>	<p>Lists the existing data assignment rules for the current EMS integration adapter.</p> <p>One rule should be defined per EMS Monitor CI.</p> <p>Use the available buttons to create, edit, activate or deactivate rules that map between fields and create the topology.</p> <p><b>Note:</b> It is important to validate the data assignment rule enrichment and if you create a custom enrichment to select the <b>Run on existing CIs</b> option in the Define Assignment Configuration dialog box.</p>
<b>4. View the integration results</b>	Click to display the view that corresponds to the integration you have created with all the CIs that were created by the integration.
<b>Description</b>	The description of the assignment.
<b>Name</b>	The name of the assignment.
<b>Status</b>	<p>The status:</p> <ul style="list-style-type: none"> <li>▶ <b>Running.</b> The assignment is running on the appropriate CIs.</li> <li>▶ <b>Stopped.</b> The assignment is not running.</li> </ul>

### CIT Relationships Map Dialog Box

<b>Description</b>	<p>Enables you to add elements and relationships to the CIT relationships map.</p> <p><b>To access:</b> Click <b>Define the CIT relationships map</b> in the Add Integration Dialog Box.</p>
<b>Important Information</b>	Sketch the relationships map to help you when you define the data assignment rules in 1. Define the CIT relationships map in “Edit Integration Dialog Box” on page 417.

## Define Assignment Configuration Dialog Box

<b>Description</b>	Enables you to configure an assignment. <b>To Access:</b> Click the  button in the KPI Enrichment Configuration page.
<b>Important Information</b>	After you have created an assignment you cannot modify the condition. A workaround is to delete the assignment and to recreate it with a new condition.
<b>Included in Tasks</b>	“Integrate Data from Third-Party Sources (EMS Data) into HP Business Availability Center” on page 407

The following elements are included (unlabeled GUI elements are shown in angle brackets>):



GUI Element (A-Z)	Description
<b>Condition</b>	The <b>condition</b> is written in XML. It uses parameters to specify the criteria used to trigger the <b>Task</b> . For details about the parameters, see “KPI Assignment Rule – Condition” on page 441.  For details about creating a <b>condition</b> , see “Define the Condition” in <i>Using Dashboard</i> .
<b>Description</b>	The description of the assignment.
<b>Name</b>	The name of the assignment. Mandatory.
<b>Run on existing CIs</b>	Set to retroactively run the assignment on existing CIs.  When you select this option, and click <b>OK</b> , the assignment is run retroactively on the appropriate CIs with the appropriate <b>conditions</b> .  <b>Note:</b> Selecting this option does not change the status of the KPI assignment itself.

GUI Element (A-Z)	Description
<b>Status</b>	<p>It can be:</p> <ul style="list-style-type: none"> <li>▶ <b>Assignment Configuration will be stopped after creation</b> when you are creating a new assignment. After you configure the assignment the status of the assignment is automatically set in <b>Stopped</b> status in the Edit Group page if you are using KPI Assignments in Dashboard or in the Add Integration page if you are using EMS Integration.</li> <li>▶ <b>Stopped</b> or <b>Running</b> depending on the status of the assignment you are editing.</li> </ul>
<b>Task</b>	<p>The task is written in XML. It uses parameters to define the tasks used to assign the KPIs, rules, and context menus to the selected CI are listed in the following table. The task that is performed after the assignment is triggered. For details, see “KPI Assignment Rule – Task” on page 444.</p> <p>For details about creating a task, see “Define the Task” in <i>Using Dashboard</i>.</p>
<b>Validate</b>	<p>Click to validate the XML code in both the Condition and Task areas and to perform the indentation of the code.</p>

## EMS Integrations Admin Page

<b>Description</b>	Lists existing EMS integrations, and enables you to define new integrations or edit existing ones.  <b>To access:</b> Select <b>Admin &gt; EMS Integrations &gt; EMS Integrations Admin</b>
<b>Important Information</b>	This dialog box also enables you to access the HP OVO and HP Service Center predefined integrations to integrate HP OVO or HP Service Center data into HP Business Availability Center.
<b>Included in Tasks</b>	“Integrate Data from Third-Party Sources (EMS Data) into HP Business Availability Center” on page 407

The following elements are included (unlabeled GUI elements are shown in angle brackets>):

<b>GUI Element (A-Z)</b>	<b>Description</b>
	Click to create a new integration. The Add Integration dialog box opens.
	Select an integration and click to edit. The Add Integration dialog box opens.
	Select an integration and click to delete.
<b>Name</b>	The name of the integration.
<b>Description</b>	The description of the integration.



# 9

---

## HP OVO Integration

This chapter describes the HP OVO integration.

### **This chapter includes:**

#### Concepts

- ▶ Understanding the HP OVO Integration on page 425

#### Tasks

- ▶ Use the EMS Integration Tool for HP OVO Server Events on page 429

### **Understanding the HP OVO Integration**

The HP OVO Integration enables connecting to the HP OVO message infrastructure, receiving events from the HP OVO server, and forwarding these events to the SiteScope machine.

This section describes the main concepts of the HP OVO integration adapter. For details on creating an HP OVO integration, see “Use the EMS Integration Tool for HP OVO Server Events” on page 429.

This section includes the following topics:

- ▶ “Overview of HP OVO” on page 426
- ▶ “OVO Hierarchies” on page 426
- ▶ “CIs and KPIs for HP OVO” on page 426
- ▶ “OVO Rules” on page 428

- ▶ “OVO Context Menus, Context Menu Items, and Tooltips in Dashboard” on page 428
- ▶ “CI Update Mechanism” on page 429

## Overview of HP OVO

HP OVO is a suite of software applications, which allow large-scale system and network management of your organization's IT assets.

## OVO Hierarchies

When you select this integration adapter and enable the KPI enrichment, the relevant CIs, hierarchy, and pattern view are created in the CMDB. You can then view the hierarchy in the OVO Hosts and Applications view in the View Manager tab in UCMDB Administration.

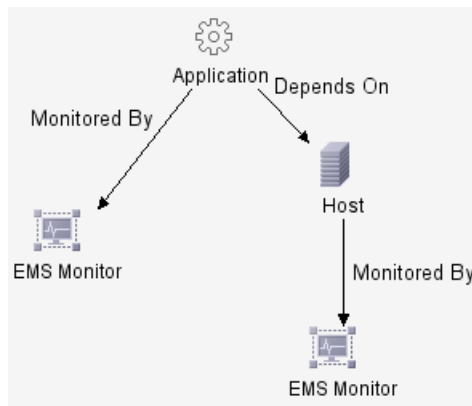

## CIs and KPIs for HP OVO

**EMS Monitor** CIs for the monitored OVO system are created in the CMDB, based on the samples sent by the SiteScope HP OVO Event monitor. The OVO KPI enrichment adds KPIs, rules, context menus, context menu items, and tooltips to those CIs. Status for these CIs can be viewed in Dashboard in the OVO Hosts and Applications view. and the CIs are available to add to SLAs in Service Level Management.

Service Level Management has its own sets of KPIs and rules that are attached to CIs within agreements.

For details about SiteScope samples, see “Data Samples for SiteScope” in *Reference Information*.

---

**Note:** Host CIs created in the CMDB by the discovery process and Host CIs created by SiteScope must be reconciled. For details, see “Reconciliation of Hosts” on page 405.



---

The following KPIs are preconfigured to work with OVO EMS Monitor CIs in Dashboard and in Service Level Management: **Application**, **Network**, **Security**, and **System**. For details, see “Use the EMS Integration Tool for HP OVO Server Events” on page 429.

---

**Note:** When multiple KPIs are assigned to an EMS Monitor CI, the status of a KPI that did not correspond to a sample is **Not up to date**. The date displayed in the **Held status since** field displays the date and time corresponding to the first time the rule was activated by a sample. The **Not up to date** status persists until the rule is activated by a sample that corresponds to the KPI.

---

	<b>System</b>
<b>CI name:</b>	labm2sun02.devlab.ad
<b>Status:</b>	Warning
<b>Calculation Rule:</b>	Worst Child Rule
<b>Held status since:</b>	2/27/07 04:35:26 AM
	<b>Security</b>
<b>CI name:</b>	labm2sun02.devlab.ad
<b>Status:</b>	Not up to date
<b>Held status since:</b>	2/27/07 04:22:59 AM
	<b>Network</b>
<b>CI name:</b>	labm2sun02.devlab.ad
<b>Status:</b>	Not up to date
<b>Held status since:</b>	2/27/07 04:22:59 AM

## OVO Rules

The rules are as follows:

- ▶ **Dashboard rules for OVO:** In Dashboard, each OVO KPI (attached to an EMS Monitor CI) uses the **SiteScope EMS Multiple Events** monitor rule. The rule handles the samples sent to HP Business Availability Center by the EMS system. It aggregates all the samples received from a specified CI. The rule saves up to ten events. If there are more than ten events, the rule discards samples with the lowest severity (critical is highest) and then the oldest samples.

For details, see “List of Dashboard Business Rules” in *CI Attribute Customization*.

- ▶ **Service Level Management rules for OVO:** In Service Level Management, each OVO KPI (attached to an EMS Monitor CI) uses its own monitor rule. For details, see “List of Service Level Management Business Rules” in *CI Attribute Customization*.

## OVO Context Menus, Context Menu Items, and Tooltips in Dashboard

The **EMS Clear Event** context menu, **Clear Event** context menu item, and **SiteScope EMS Rule** tooltip are preconfigured to work with OVO EMS Monitor CIs in Dashboard.

For details about the context menu, see “EMS Show Events” in *CI Attribute Customization*.

For details about the context menu item, see “Show Events” in *CI Attribute Customization*.

For details about the tooltip, see “SiteScope EMS Rule” in *CI Attribute Customization*.

The OVO Drill Down event enables you to access the HP OVO application. For details about the context menu, see “OVO Drill Down Event” in *CI Attribute Customization*.

## CI Update Mechanism

Any time an event is updated in HP OVO, another sample is sent to HP Business Availability Center and the status of the relevant CI is updated. This includes events that cause a status change and a Clear Event that changes the current status back to green. The period of time from the time the last sample was received for a KPI until the KPI is timed out (and its status changes to grey) is defined in the KPI's **No data timeout** rule parameter that can be specified in **Admin > Dashboard > KPIs** or for the individual KPI, in the rule definition (global change) in **Admin > Dashboard > Repositories > Business Rules**.

## Use the EMS Integration Tool for HP OVO Server Events

You can collect performance and availability data from an existing HP OVO Server and view the events in HP Business Availability Center applications.

To integrate events from an existing HP OVO Server, use the following steps:

---

**Note:** Complete each step before starting on the next step.

---

For additional information about EMS integration, see “Enterprise Management Systems and the EMS Integrations Application Overview” on page 402.

This task includes the following steps:

- “Install HP OVO Integration Add-on” on page 430
- “Specify the Server Where HP OVO is Running” on page 430
- “Configure the HP OVO Event Monitor” on page 431
- “Customize the Integration – Optional” on page 431
- “Activate the Data Assignment Rules” on page 431
- “Display the HP OVO View” on page 431

- “Activate OVO Hosts and Applications View” on page 432
- “Customize Automated Mapping Between OVO Event Fields and KPIs – Optional” on page 432
- “Assign the OVO EMS Monitor CI to SLAs and Add Optional KPIs” on page 433
- “Results” on page 433

## 1 Install HP OVO Integration Add-on

The HP OVO Integration Add-on enables connecting to the HP OVO message infrastructure, receiving events from the HP OVO server, and forwarding these events to the SiteScope machine. For details, see “HP OVO Event Monitor” in *Using System Availability Management*.

## 2 Specify the Server Where HP OVO is Running

This information is used to drill down from HP Business Availability Center to HP OVO using the OVO Drill Down context menu option in Dashboard from the HP OVO view. To specify the server information, use one of the following options:

- Select **Admin > EMS Integrations**, select HP OVO and click Edit. In the Edit Integration dialog box, enter the Host and User information. For details, see “Edit Integration Dialog Box” on page 417.
- Select **Admin > Platform > Setup and Maintenance > Infrastructure Settings**, choose **Foundations**, select **Integrations with other applications**, and in the Integrations with other applications – HP OVO table, use of the following options:
  - Enter the appropriate information in **The OVO Host, User of the OVO,** and **User Password of the OVO** entries.
  - Enter the URL of the server where HP OVO is running in the **HP OVO drilldown url** entry. For example: [http://OVOMHostExample:3443/OvCgi/ito\\_op\\_applet.cgi.ovpl?gui.dftlayout=true&gui.msgbrw.brwpane=true&https=true](http://OVOMHostExample:3443/OvCgi/ito_op_applet.cgi.ovpl?gui.dftlayout=true&gui.msgbrw.brwpane=true&https=true)

This information is reflected in the Add Integration dialog box for HP OVO.

### 3 Configure the HP OVO Event Monitor

The monitor is used to retrieve data from the HP OVO server using System Availability Management Administration. You add the HP OVO Event Monitor to a SiteScope monitor group created for this monitor and other Integration Monitor types. It is recommended that you configure Integrations Monitors only after a connection between the SiteScope and HP Business Availability Center is established. For details, see “HP OVO Event Monitor” in *System Availability Management*.

---

**Note:** SiteScope cannot be deployed behind a firewall. SiteScope and the monitored system must be on the same LAN or special firewall configuration might be required.

---

### 4 Customize the Integration – Optional

You can use the EMS Integrations application to customize an HP OVO integration. The integration forwards the retrieved data captured from the OVO system by the SiteScope HP OVO Event monitor to HP Business Availability Center, and creates the appropriate topology (host and application CIs). For details on the available customizations, see “Define Assignment Configuration Dialog Box” on page 422.

### 5 Activate the Data Assignment Rules

By default, HP OVO data Assignment rules are stopped.



To activate the data assignment rules, select **Admin > EMS Integrations**, select HP OVO, click Edit, select the assignment rule, and click **Activate**.

### 6 Display the HP OVO View

This view is similar to the OVO Hosts and Applications view. It is automatically activated. The topology of the HP OVO integration is displayed in this view and in the OVO Hosts and Applications View.

## 7 Activate OVO Hosts and Applications View

This view is mainly used for backward compatibility. To see the topology in this view, you must activate the view and assign the view to the required Business Availability Center applications. For details on activating the view, see **Activate/Deactivate View** in “View Manager Window” in *Model Management*.

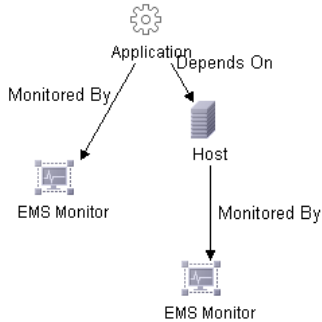

## 8 Customize Automated Mapping Between OVO Event Fields and KPIs – Optional

The HP OVO integration is configured to automatically map the events retrieved from the HP OVO system to the appropriate KPIs for the corresponding EMS Monitor CIs. The appropriate KPIs, rule, context menu items, and tooltips are used to display the retrieved data.

Use the Clear Event context menu item to clear events in Dashboard only.

Use the OVO Drill Down context menu items to open the HP OVO application. For details, see “Understanding the HP OVO Integration” on page 425.

After you begin working with the data, you can optionally customize these mappings. For details, see “HP OVO Event Monitor” in *System Availability Management*.



## 9 Assign the OVO EMS Monitor CI to SLAs and Add Optional KPIs

You can include OVO EMS Monitor CIs in your SLAs in Service Level Management. Service Level Management contains KPIs and rules specifically configured for OVO EMS Monitor CIs, including optional KPIs for network and security. For details, see “Integration with HP OVO” in *Using Service Level Management*.

## 10 Results

After the task is performed, HP OVO data is integrated into HP Business Availability Center as described in this section.

### ► View OVO Events in Dashboard and Service Level Manager Views

SiteScope automatically creates the appropriate topology when HP OVO events are integrated into HP Business Availability Center. HP Business Availability Center adds the data to the views in Dashboard and Service Level Management.

In both Dashboard and Service Level Management, the Application, System, Network, and Security KPIs are defined as default KPIs for the OVO EMS Monitor CIs. For details on the KPIs, see “KPI Repository” in *CI Attribute Customization*.

### ► Drill Down to HP OVO from the Dashboard and Service Level Manager Views

Use the right-click menu option: OVO Drill Down for the appropriate CIs in the Dashboard and Service Level Management views to access the HP OVO application.

---

**Note:** If the drill down option does not work, check that you are using LW-SSO. For details about LW-SSO, see “Lightweight Single Sign-On Authentication” in *Platform Administration*.

---



# 10

---

## Configure HP ServiceCenter for Integration with HP Business Availability Center

This chapter has been replaced by the "HP Service Manager Integration with Dashboard and Service Level Management" chapter in the SM\_integration.pdf file distributed with the 7.53 Service Pack.

This chapter describes how to configure HP ServiceCenter before performing its integration with HP Business Availability Center.

### **This chapter includes:**

#### **Tasks**

- Configure HP ServiceCenter on page 435
- Before you Upgrade HP ServiceCenter From Previous Versions on page 449

### **Configure HP ServiceCenter**

This task describes how to configure HP ServiceCenter.

This task includes the following steps:

- "Prerequisites" on page 436
- "Set Up the sc.cfg File" on page 436
- "Load the Integration Tailoring Materials" on page 438
- "Configure URLs for the Integration" on page 439
- "Modify the web.xml File" on page 443
- "Configure the Symphony Adapter for ServiceCenter and Service Manager" on page 444

- “Modify the application-context.xml File” on page 446
- “Initial Sample Event in ServiceCenter” on page 447
- “Set Up and Configure Connect-IT” on page 448
- “Perform the Integration” on page 448

## 1 Prerequisites

- The ServiceCenter server, ServiceCenter Web tier, and ServiceCenter Windows client components of HP ServiceCenter must be installed. For details, see ServiceCenter Installation guide.
- Optional. If you want HP ServiceCenter to use the SSL-based Trusted Sign-on protocol, configure it according to the instructions in the HP ServiceCenter on-line help.

---

**Note:** Plan to put both the ServiceCenter Web tier and the Symphony Adapter webapp in the same container, so you can use the same certificate for both.

---

## Support Matrix

The support matrix for HP ServiceCenter is as follows:

Integration Matrix	ServiceCenter 6.26	Service Manager 7.0
Incident Submission	Supported	Not supported
Problem Isolation	Supported	Not supported
Federation	Supported	Supported
Ticketing	Supported	Supported

## 2 Set Up the sc.cfg File

Once the server is installed, you can start and stop it using the Windows services utility, or by using **net start** and **net stop** commands. It is recommended that you do the following immediately upon completion of the installation and configuration dialogs:

- a Stop the server using a net stop ServiceCenter command.
- b Edit the **sc.cfg** file found in the RUN folder of the Server installation folder. Typically the location of this folder is  
**c:\Program Files\Peregrine Systems\ServiceCenter 6.2\Server\RUN**
- c Enable the servlet and the listener for connect-it on port 12670, the other parameters should be commented out to disable unnecessary processes that might slow down startup and shutdown and to avoid cluttering the **sc.log** file with lots of unnecessary messages.

Make sure that the bolded lines in the modified **sc.cfg** file are as follows (the line **scenter -listener:<listener\_port>** should provide the port of the listener):

```
#
# ServiceCenter Server Configuration File
#
# Used by ServiceCenter service to start the ServiceCenter processes.
#
#####
#
# Copyright 1994-2007 Hewlett-Packard Development Company, L.P.
# All Rights Reserved
#
#####
#
# start a J2EE/servlet listener for HTTP clients: Windows, web, SOAP-API
#
scenter -servletcontainer -httpPort:13080 -httpsPort:13443
#
# Start a listener for Get-It, Connect-It, ODBC driver
#
scenter -listener
#
# start a listener for SCAuto
#
scenter -listener:12670
#
# start background schedulers
#
#scenter system.start
```

### 3 Load the Integration Tailoring Materials

ServiceCenter uses a proprietary binary file format known as **unload files** to contain packages of scripts, forms, file records, and other materials. By convention, these files have a filetype of **.unl** on Windows platforms.

- a** Copy the UNL file required for integration from the following location:  
<installation\_root\_directory>\BACUnload\BAC\_PI\_62\_v(X).unl  
to an accessible network location.
- b** In the Windows client, select **Start > Programs > Service Center 6.2**, and log in as a user with Administrator privileges, such as **falcon** (no password).
- c** Locate the command line text widget in the menu bar at the top of the client display, to the right of the Printer icon.
- d** Type **db** and press enter to start the Database Manager application.

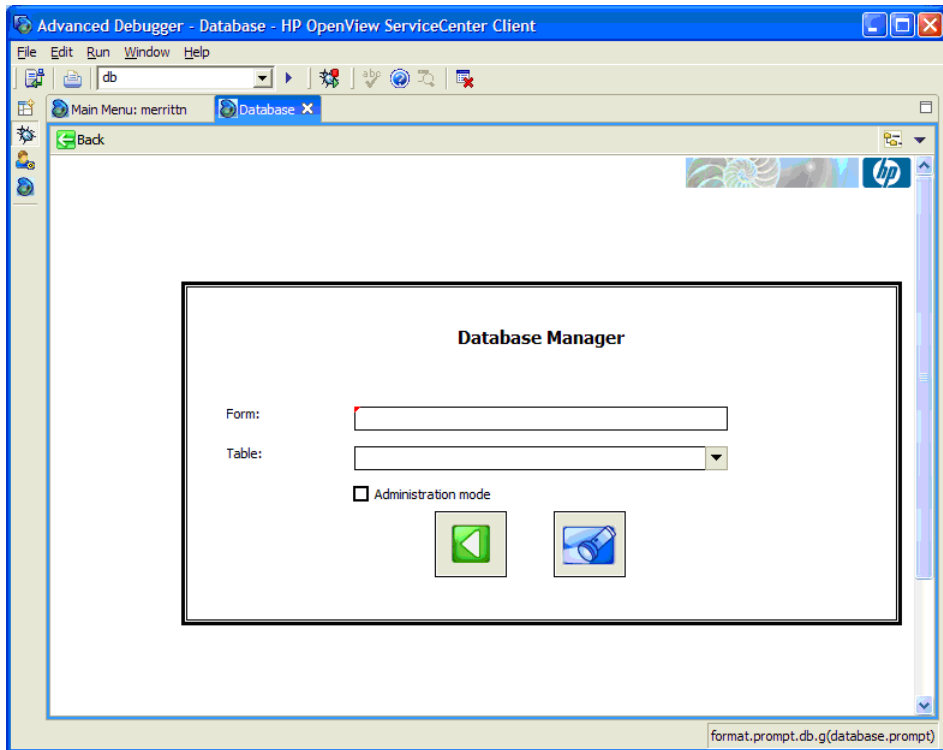

- e Right-click anywhere on the white background, and select **Import / Load** from the context menu that displays to start the ServiceCenter File Load/Import application.

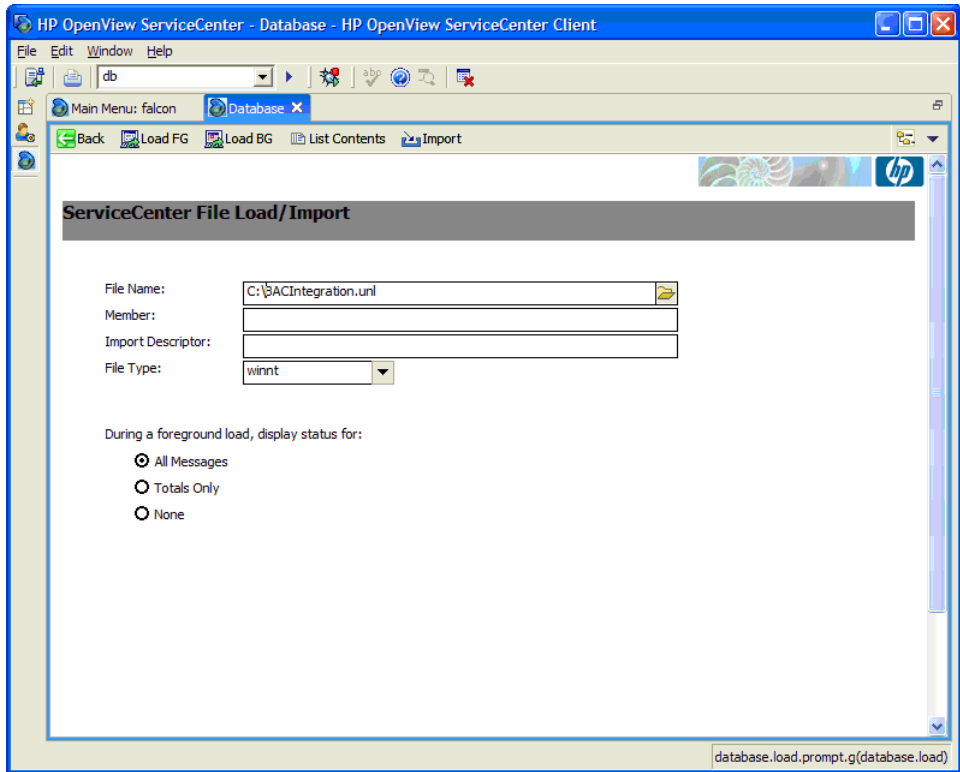

- f Click the manila folder icon  at the end of the **File Name** box and navigate to the **BAC\_PI\_62\_v(X).unl** file you saved previously, select it, and click **Open**. The screen shown above refreshes and displays with the path to the selected file.
- g Click the **Load FG** button on the toolbar to load the file.
- h Log out of the client, and restart the ServiceCenter server using the **Net stop servicecenter** and **Net start servicecenter** commands.

#### 4 Configure URLs for the Integration

To configure the integration, use the following steps:

**a** Select **Utilities > Administration** menu:

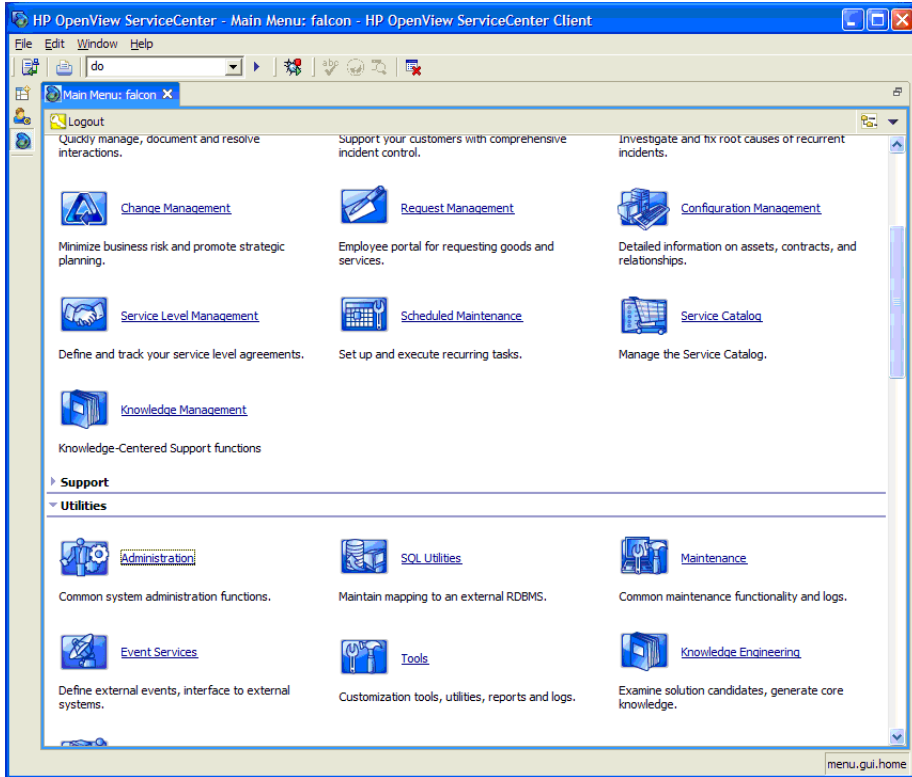



**b** Click the System Information Record menu:

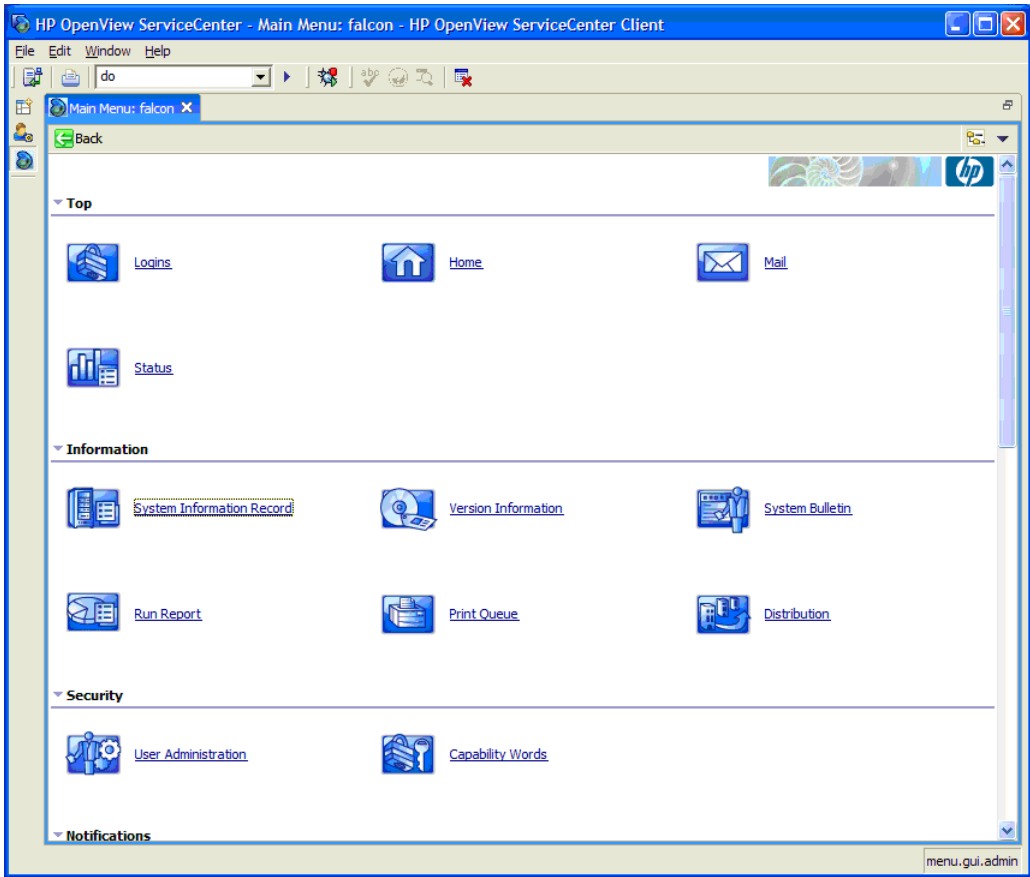

c Click the **Active Integrations** tab:

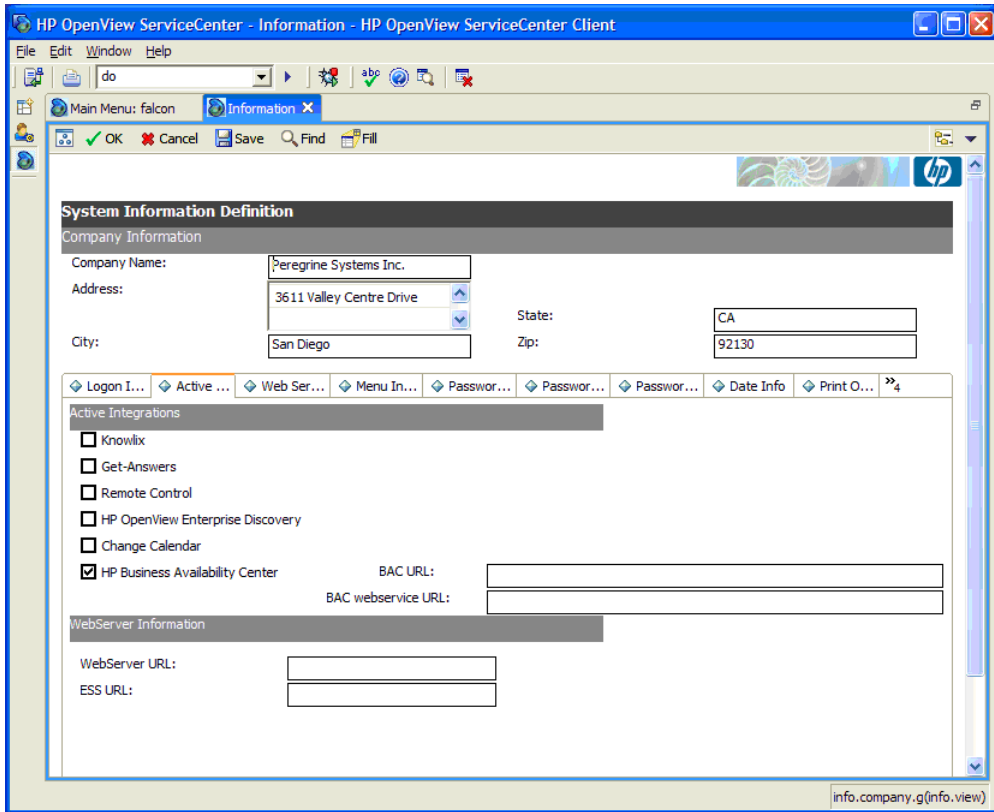

d Select the **HP Business Availability Center** checkbox.

e In the **BAC URL** box enter the URL to the BAC Gateway server (for example:  
**http://<HP Business Availability Center host>/topaz/framework/topaz\_frames.jsp**). This setting is used when launching Problem Isolation (the hostname should be the FQDN).

f In the **BAC webservice URL** box enter the URL for the EntityNotification endpoint (for example:  
**http://<HP ServiceCenter host>:<PORT>/SymphonyAdapter/outbound/ws?endpoint=http://<HP Business Availability Center host>/topaz/services/EntityNotificationPort** (the hostnames should be the FQDN).

---

**Note:** If you are using the SymphonyAdapter for LW-SSO single sign-on, the URL for the EntityNotification endpoint must be specified as the endpoint parameter of the SymphonyAdapter outbound URL (for example: `http://FQDNsymphonyadapterhost:8080/SymphonyAdapter/outbound/ws?endpoint=http://FQDNbachost:80/topaz/services/EntityNotificationPort`)

---

**g** Click **Save**.

## **5 Modify the web.xml File**

This step is needed for the integration of HP ServiceCenter and HP Business Availability Center.

After installing and configuring LW-SSO, you must modify the **web.xml** file.

- a** Access the **web.xml** file located at: **\Apache Software Foundation\Tomcat 5.5\webapps\sc\WEB-INF** by changing the **param-name** to the value indicated in bold in the code below.

```
<!-- Enables submission of form when the user presses the ENTER key. -->
  <init-param>
    <param-name>sc.autosubmit</param-name>
    <param-value>>true</param-value>
  </init-param>

<!-- Change value (e.g. 1, or 2) to increase horizontal spacing, useful for avoiding
clipping problems with localized versions -->
  <init-param>
    <param-name>sc.hscale</param-name>
    <param-value>0</param-value>
  </init-param>

<!--
*****
The following parameters can't be supplied in the URL: they can only be changed in
web.xml
*****
-->
  <init-param>
    <param-name>sc.querysecurity</param-name>
    <param-value>>false</param-value>
  </init-param>

<!-- Control the encryption of network communication between the application server
and the ServiceCenter server -->
  <init-param>
    <param-name>sc.ssl</param-name>
    <param-value>>false</param-value>
  </init-param>
```

- b** Restart the Tomcat container using the **Net stop tomcat** and **Net start tomcat** commands.

## 6 Configure the Symphony Adapter for ServiceCenter and Service Manager

This section describes how to configure the Symphony Adapter for ServiceCenter and Service Manager:

- a** Locate the **web-inf\classes** folder for the SymphonyAdapter webapp.
- b** Copy the **cacerts** file and **client keystore** file you created using the **makeadaptercert** script into the **web-inf\classes** folder of the SymphonyAdapter webapp. For details, see the HP ServiceCenter on-line help.
- c** Edit the **SymphonyAdapter.properties** file to correct these settings for your installation:
  - **servicecenter.ws.targetLocationURL.** Edit the host and port as appropriate for your installation. You should use the fully qualified domain name to specify the host.
  - **servicecenter.webtier.URL.** Update this property to make the hostname and port correct for the current Tomcat container. You must provide the fully qualified domain name, because this information is going to be used to rewrite URLs, which is sent back to HP Business Availability Center with a 307 redirect. **DO NOT SPECIFY LOCALHOST.** If you do, HP Business Availability Center tries to launch the ServiceCenter web user interface locally, which does not work!
  - **clientcerts.keystore.** Update this parameter to point to the client keystore you created using **makeadaptercert**. You must use a full path name starting from the C: drive and using double slashes, for example:  

```
D:\Program Files\Apache Software Foundation\Tomcat  
5.5\webapps\SymphonyAdapter\WEB-INF\classes\<machine  
name>.client.keystore
```
  - **clientcerts.keystore.password.** Specify the correct pass-phrase for the client keystore specified above.
  - **truststore.** Specify the full path to the updated **cacerts** file you created.
  - **truststore.password.** Specify the pass-phrase for the **cacerts** file. If you did not change it, it should still be **changeit**.

---

**Note:** If a single sign-on technology is configured (LW-SSO or SiteMinder), the ServiceCenter login panel is not displayed.

---

- d** In the Acegi configuration in the ServiceCenter web tier or Symphony Adapter for LW-SSO, edit the **lwssofmconf.xml** file in **WEB-INF/classes** directory of the location where the ServiceCenter webtier was deployed.

Locate the <domain> element under <web-lwssso>:

```
<web-lwssso>
  <lwssso startLWSSO="enabled">
    <domain>my.domain.com</domain>
    <crypto cipherType="symmetricBlockCipher"
      engineName="AES" paddingModeName="CBC" keySize="256"
      encodingMode="Base64Url"initString="password">
    </crypto>
    <expirationPeriod>60</expirationPeriod>
  </lwssso>
```

Replace the bolded strings in the file with the fully qualified domain to which the web tier servers belong and where those servers are sharing authentication credentials via LW-SSO. In addition, replace the bolded password string with the password to the server where the ServiceCenter webtier was deployed; it has to match between the systems that are sharing credentials using LW-SSO in their respective config files. For example, if your HP ServiceCenter web tier is installed on `sc.mydomain.com` and HP Business Availability Center is set up on `bac.mydomain.com`, the domain you would use in this configuration file is **mydomain.com** (both in the `<lwssso><domain>mydomain.com</domain>` part and under the `<protectedDomains><url>mydomain.com</url></protectedDomains>`) below.

Add your domains to the <protectedDomains> element as follows:

```
<protectedDomains>
  <url>fully_qualified_domain</url>
  <url>fully_qualified_domain</url>
  <url>fully_qualified_domain</url>
</protectedDomains>
```

Save changes.

## 7 Modify the application-context.xml File

This section describes how to modify the applicaton-context.xml file:

- a You must modify the **application-context.xml** file in WEB-INF/classes directory of the ServiceCenter webtier. Make sure that the filterChainProxy bean definition contains the **lwSsoFilter** string as shown in the sample:

```
<bean id="filterChainProxy" class="net.sf.acegisecurity.util.FilterChainProxy">
  <property name="filterInvocationDefinitionSource">
    <value>
      CONVERT_URL_TO_LOWERCASE_BEFORE_COMPARISON
      PATTERN_TYPE_APACHE_ANT
      /**=httpSessionContextIntegrationFilter,lwSsoFilter,anonymousProcessingFilter
    </value>
  </property>
</bean>
```

- b Make sure that the following lines are available (uncommented) at the bottom of the application-context.xml:

```
  <bean id="lwSsoFilter"
class="com.peregrine.eclipse.web.lwssso.LwSsoPreAuthenticationFilter">
  <property name="authenticationManager">
    <ref bean="authenticationManager"/>
  </property>
  <property name="defaultRole">
    <value>ROLE_PRE</value>
  </property>
</bean>

<bean id="lwSsoIntegrationBean"
class="com.peregrine.eclipse.web.lwssso.LwSsoIntegration"/> </bean>
```

For detailed instructions on configuring LWSSO please refer to the LWSSO documentation. Save changes.

- c Restart the Tomcat container using **Net stop tomcat** and **Net start tomcat** commands.

## 8 Initial Sample Event in ServiceCenter

Open the ServiceCenter application and perform the following steps:

- a From the System Navigator, select **Menu Navigation > Tailoring > Database Manager**.

- b** Select the **Administrative Mode** option.
- c** Enter **apm.global.list.entry** in the **Form** box.
- d** Click **Search** to open a blank record from the **globallists** file.
- e** Click **Search** to display a list of lists.
- f** Select **Mass Update**. A blank update screen opens. This form is identical in appearance to the lister record, but contains different option buttons.
- g** Set the date in the **Expiration** box to any date in the past, for example, 01/01/90.
- h** Click **Simple Update** to reset the expiration date of all the lists in the **globallists** file.
- i** Return to the home menu.
- j** Enter **\*aapm.server.initer** in the command line and click **Enter**.
- k** Log out of ServiceCenter and log in again.  
All the lists in the system are regenerated and ServiceCenter processes all the current records.

## 9 Set Up and Configure Connect-IT

You must set up and configure Connect-IT for the integration with HP Business Availability Center if you want to automatically open tickets in HP ServiceCenter when relevant alerts are triggered in HP Business Availability Center. For details, see the BAC KPI Monitoring to Incident Management Integration guide.

## 10 Perform the Integration

After you finish configuring HP ServiceCenter you must perform the integration between HP ServiceCenter and HP Business Availability Center. For details, see “Use the EMS Integration Tool for HP ServiceCenter Data” on page 456.



## Before you Upgrade HP ServiceCenter From Previous Versions

It is recommended to back up the following files before performing the upgrade procedure to version 6.26. For details about the upgrade see HP ServiceCenter documentation.

- ▶ **ServiceCenter Server**
  - ▶ <ServiceCenter Server Home>/RUN/sc.ini
  - ▶ <ServiceCenter Server Home>/RUN/cacerts
  - ▶ <ServiceCenter Server Home>/RUN/trustedclients.jks
  - ▶ <ServiceCenter Server Home>/RUN/hostname.devlab.ad.keystore (this filename varies by machine)
- ▶ **ServiceCenter Webtier**
  - ▶ <SC.WAR DIR>/WEB\_INF/cacerts
  - ▶ <SC.WAR DIR>/WEB\_INF/hostname.devlab.ad.client.keystore (this filename varies by machine)
  - ▶ <SC.WAR DIR>/WEB\_INF/web.xml
  - ▶ <SC.WAR DIR>/WEB\_INF/classes/application-context.xml
  - ▶ <SC.WAR DIR>/WEB\_INF/classes/lwssofmconf.xml
- ▶ **Symphony Adapter**
  - ▶ < SymphonyAdapter.war DIR>/WEB\_INF/classes/hostname.devlab.ad.client.keystore (this filename varies by machine)
  - ▶ < SymphonyAdapter.war DIR>/WEB\_INF/classes/cacerts
  - ▶ < SymphonyAdapter.war DIR>/WEB\_INF/classes/lwssofmconf.xml
  - ▶ < SymphonyAdapter.war DIR> /WEB\_INF/classes/SymphonyAdapter.properties

The Data files are not overwritten. If you want to start with clean data, you need to delete the Data folder. After you reapply the **BAC\_PA\_62\_v1.unl** you must reconfigure the two URL settings.



# 11

---

## HP ServiceCenter Integration

This chapter has been replaced by the "HP Service Manager Integration with Dashboard and Service Level Management" chapter in the SM\_integration.pdf file distributed with the 7.53 Service Pack.

This chapter describes the HP ServiceCenter integration.

---

**Note:** HP Business Availability Center integrates with both HP ServiceCenter and HP ServiceManager though only HP ServiceCenter is mentioned in this chapter.

---

### **This chapter includes:**

#### Concepts

- Understanding the HP ServiceCenter Integration on page 451

#### Tasks

- Use the EMS Integration Tool for HP ServiceCenter Data on page 456

### **Understanding the HP ServiceCenter Integration**

This section describes the main concepts of the HP ServiceCenter integration adapter.

This section includes the following topics:

- “Overview of HP ServiceCenter” on page 452
- “HP ServiceCenter Integration” on page 452
- “CIs and KPIs for HP ServiceCenter” on page 454
- “HP ServiceCenter Rules” on page 455

- ▶ “HP ServiceCenter Context Menus, Context Menu Items, and Tooltip” on page 455

## Overview of HP ServiceCenter

HP ServiceCenter software is a comprehensive and fully integrated IT service management suite that helps you decrease the time it takes to resolve problems. ITIL-based best practices and a highly scalable service-oriented architecture let you deploy consistent, integrated processes throughout your IT organization. HP ServiceCenter provides the following capabilities:

- ▶ Automate service management processes for incident, problem, change, configuration, availability, release, contract, catalog-based requests and service level management.
- ▶ Use built-in workflows to document, route and escalate issues for IT service management processes.
- ▶ Gain access to comprehensive configuration data through a powerful CMDB.
- ▶ Deploy solution easily across heterogeneous environments using an open architecture and web-based framework.

## HP ServiceCenter Integration

The integration of HP ServiceCenter in HP Business Availability Center offers the following capabilities:

- ▶ **In Dashboard:**
  - ▶ You can view the Number of Opens Incidents KPI (based on data from HP ServiceCenter) at the business service level in the Dashboard views and reports. For details, see “Dashboard Tabs” in *Using Dashboard*.  
  
For example: the Operator/Application support can get visibility and alerts based on the Number of Open Incidents in HP Business Availability Center Dashboard alongside operational KPIs.
  - ▶ You can drill down from Dashboard views at the business service level to HP ServiceCenter to view the details of the related incidents.

For example: The support person can drill down to HP ServiceCenter to view the details on the open incidents of the selected service. Based on the number of incidents and their details, the support person can prioritize the issues that are the most important.

► **Incident submission:**

You can define, in Alerts Administration, CI Status Alerts that automatically open a related incident in HP ServiceCenter when the alert is triggered.

For details, see “Set Up to Open a Ticket in HP ServiceCenter When the Alert is Triggered” in *Alerts*.

► **Service Level Management:**

You can define SLAs based on Serviceability KPIs (MTTR, MTBF, or MTBSI KPIs) that are calculated based on incidents that come from HP ServiceCenter. For details, see “Agreements in Service Level Management” in *Using Service Level Management*.

For example: the Service Manager manages SLAs with operational (Availability, Performance, or other KPIs) and serviceability (MTTR, MTBF, or MTBSI KPIs) using HP Business Availability Center Service Level Management. The Service Manager can review the SLAs statuses according to the service Availability, Performance, MTTR and MTBF side-by-side.

► **Problem isolation:**

You can:

- Attach a problem in Problem Isolation to an existing or new incident in HP ServiceCenter.
- Attach a problem snapshot to the incident in HP ServiceCenter.
- Drill down from the incident context in HP ServiceCenter to the appropriate problem in Problem Isolation.
- Proactively manage problems using the correlation of incidents and requests for change in HP ServiceCenter with the operational matrix like Availability or Performance that are integrated from different sources like End User Management, into Problem Isolation

For details about Problem Isolation, see “Problem Isolation and HP ServiceCenter Integration” in *Using Problem Isolation*.

For example:

- 1** The operator detects a problem in the CRM application through the HP Business Availability Center Dashboard and selects to go to Problem Isolation.
- 2** The operator opens an incident/problem in HP ServiceCenter from Problem Isolation or associates the isolation to an existing incident/problem (for example an incident/problem automatically opened through the incident submission).
- 3** Once associated the incident/problem details are available in the isolation properties. Going through the isolation process, the operator finds that the problem resides in the Database and in HP ServiceCenter, assigns the incident to the DBAs.
- 4** The operator generates a snapshot report that includes all the isolation details and attaches it to the incident/problem so the DBAs have all the required information for further analysis.
- 5** In HP ServiceCenter, the incident/problem owner reviews the incident/problem information and finds the Problem Isolation snapshot report that is attached to the incident/problem. The incident/problem owner reviews the snapshot report to understand the different aspects of the problem, and has the option of drilling down from the snapshot report to the specific problem in HP Business Availability Center – Problem Isolation to further triage the problem.

## **CIs and KPIs for HP ServiceCenter**

The HP ServiceCenter integration creates EMS Monitor CIs for the monitored HP ServiceCenter system, based on the samples sent by the SiteScope HP ServiceCenter Monitor. Status for these CIs can be viewed in Dashboard in the Business Services and the Service Measurements views, and the CIs are available to add to SLAs in Service Level Management.

The KPIs that are preconfigured to work with HP ServiceCenter Monitor CIs are **Number of Open Incidents** in Dashboard and **MTTR** (Mean Time to Repair), **MTBF** (Mean Time Between Failures), and **MTBSI** (Mean Time Between System Incidents) in Service Level Management. Each KPI uses different business rules and logic in each application.

## HP ServiceCenter Rules

The HP ServiceCenter integration uses the following rules:

- ▶ **Dashboard rule for HP ServiceCenter:** In Dashboard, each HP ServiceCenter KPI (attached to an EMS Monitor CI) uses the **Number of Open Incidents** monitor rule. The rule handles the samples sent to HP Business Availability Center by the EMS system.

For details about the rule, see “Number of Open Incidents” in *CI Attribute Customization*.

- ▶ **Service Level Management rules for HP ServiceCenter:** In Service Level Management, each HP ServiceCenter KPI (attached to an EMS Monitor CI) uses its own monitor rule. For details, see “List of Service Level Management Business Rules” in *CI Attribute Customization*.

## HP ServiceCenter Context Menus, Context Menu Items, and Tooltip

The HP SC Menu context menu, HP ServiceCenter context menu item, and SiteScope EMS Rule tooltip are preconfigured to work with OVO EMS Monitor CIs in Dashboard.

For details about the context menu, see “HP SC Menu” in *CI Attribute Customization*.

For details about the context menu item, see “HP ServiceCenter” in *CI Attribute Customization*.

For details about the tooltip, see “Number of Open Incidents Sentence” in *CI Attribute Customization*.

## Use the EMS Integration Tool for HP ServiceCenter Data

You can collect performance and availability data from an existing HP ServiceCenter Server and view the data in HP Business Availability Center applications.

To integrate data from an existing HP ServiceCenter, use the following steps:

---

**Note:** Complete each step before beginning the next step.

---

This task includes the following steps:

- “Prerequisite Step” on page 456
- “Configure the HP ServiceCenter Monitor” on page 457
- “Specify the HP ServiceCenter URL” on page 457
- “Specify the State and Severity of Open Incidents to Be Displayed” on page 457
- “Configure the ServiceCenter Integration” on page 458
- “Automatically Open a Ticket in HP ServiceCenter When an Alert is Triggered” on page 459
- “Customize the Integration Adapter – Optional” on page 459
- “Include Service Center CIs in Service Level Management Agreements” on page 459
- “Enable Accessing HP ServiceCenter from Within Dashboard” on page 459
- “Results” on page 460

### **1 Prerequisite Step**

Perform the HP ServiceCenter configuration steps described in “Configure HP ServiceCenter” on page 435.



## 2 Configure the HP ServiceCenter Monitor

In SiteScope, you must provide external access to the clocks and `probe_summary_tables`, edit the topology script, create the `peregrine.jar` file, edit the attributes mapping files and the `ticket.config` file, and more. For details, see “HP ServiceCenter Integration – Workflow” in *Using System Availability Management*.

## 3 Specify the HP ServiceCenter URL

To specify the HP ServiceCenter URL, select **Admin > Platform > Setup and Maintenance > Infrastructure Settings**, select **Foundations**, select **Integrations with other applications**, and, in the Integrations with other applications - Incidents Integration table, enter the appropriate URL in the **ServiceCenter/ServiceManager web tier URL** entry, using the following format: `<protocol>://<host_name>:<port>/<web_app_name>/` where **host\_name** is the name of the ServiceCenter server, **port** is the port number of the ServiceCenter server, and **web\_app\_name** is the name of the application (for example the URL for HP Business Availability Center would be: `<protocol>://<host_name>:<port>/topaz/`).

## 4 Specify the State and Severity of Open Incidents to Be Displayed

To specify the state and severity of the open incidents to be displayed, you can edit the parameters of the **Number of incidents** rule parameters:

- **For the Number of Open Incidents KPIs attached to a specific EMS Monitor CI.** Access the Edit KPI dialog box, expand the Business Rule area and modify the state and severity values. For details, see “How Dashboard KPIs Work” in *Using Dashboard*.
- **Globally, for all KPIs defined with the Number of Open Incidents rule.** Override the Number of Open Incidents rule in the Repositories, edit the Initial State, Final State, and Severity parameters. For details, see “Rule Details Dialog Box” in *CI Attribute Customization*.

For details about the parameters, see “Number of Open Incidents” in *CI Attribute Customization*.

**Note:** The values available for the Initial State, Final State, and Severity parameters reflect the values defined in HP ServiceCenter.

---

## 5 Configure the ServiceCenter Integration

The HP ServiceCenter integration adapter is predefined.

Select **Admin > EMS Integrations**, select **ServiceCenter** and click Edit. In the Edit Integration dialog box:

- ▶ **Configure the HP ServiceCenter Monitor.** The monitor is used to retrieve data from EMS system using System Availability Management Administration. You add the HP ServiceCenter Monitor to a SiteScope monitor group created for this monitor and other Integration Monitor types. It is recommended that you configure Integrations Monitors only after a connection between the SiteScope and HP Business Availability Center is established.

---

**Note:** SiteScope cannot be deployed behind a firewall. SiteScope and the monitored system must be on the same LAN or special firewall configuration might be required.

---

- ▶ **Activate the data assignment rules.** Select the assignment rule and click **Activate**.

When the EMS monitor sample includes open incidents in its data source, the Number of Open Incidents KPI (**2600**), the Number of Open Incidents rule (**2600**), the HP SC Menu context menu (**hpsc**), the HP ServiceCenter context menu item, and the HP Open Incidents tooltip (**2600**) are assigned to the EMS Monitor CI.

For details, see “Add Integration Dialog Box” on page 415.

## **6 Automatically Open a Ticket in HP ServiceCenter When an Alert is Triggered**

You can automatically open a ticket in HP ServiceCenter when a CI Status is triggered. For details, see “Set Up to Open a Ticket in HP ServiceCenter When the Alert is Triggered” in *Alerts*.

## **7 Customize the Integration Adapter – Optional**

You can use the EMS Integrations application to customize an HP ServiceCenter integration. The integration forwards the retrieved data captured from the HP ServiceCenter system by the SiteScope HP ServiceCenter monitor to HP Business Availability Center, and creates the appropriate topology that is used to display the data in Dashboard.

For details on the available customizations, see “Define Assignment Configuration Dialog Box” on page 422.

## **8 Include Service Center CIs in Service Level Management Agreements**

You can include Service Center EMS Monitor CIs in your agreements in Service Level Management. Service Level Management contains KPIs and rules specifically configured for Service Center EMS Monitor CIs. The MTTR, MTBF, and MTBSI KPIs and the MTTR, MTBF, and MTBSI rules are dedicated for this integration.

You must also configure the incident initial and final state in those rules. For details, see “Incident State and Severity Values” in *Using Service Level Management*.

For details about the integration, see “Integration with HP ServiceCenter” in *Using Service Level Management*.

## **9 Enable Accessing HP ServiceCenter from Within Dashboard**

You must disable query security to the HP ServiceCenter application to enable accessing the application, through the right-click **HP ServiceCenter** menu option in Dashboard. You still have the necessary capabilities to properly secure your system without the query hash.

To enable accessing **HP ServiceCenter** from within Dashboard:

- a** Edit the **web.xml** file. The location of the file depends on the type of web application server the web tier is deployed on.
- b** In the file, locate the **<!-- Specify the ServiceCenter server host and port location -->** section.
- c** Add the following strings into the section:  

```
<context-param>  
<param-name>sc.querysecurity</param-name>  
<param-value>>false</param-value>  
</context-param>
```

## 10 Results

After the task is performed, HP ServiceCenter data is integrated into HP Business Availability Center as described in this section.

► **View ServiceCenter Data in Dashboard and Service Level Management:**

SiteScope automatically creates the appropriate topology when HP ServiceCenter data is integrated into HP Business Availability Center. HP Business Availability Center adds the data to the Business Services and Service Measurement views, and you can display these views in Dashboard and Service Level Management.

► **Drill down to HP ServiceCenter from Dashboard views:**

In Dashboard, in the Business Services and Service Measurement views, use **HP ServiceCenter** option available for HP ServiceCenter CIs to access the relevant incident in the HP ServiceCenter application. For information about the HP ServiceCenter application, consult the HP ServiceCenter documentation.

---

**Note:** You can also integrate Problem Isolation with HP ServiceCenter to link isolation data (from Problem Isolation) with incident or problem data (from HP ServiceCenter), to create a complete problem management lifecycle. For details, see “Problem Isolation and HP ServiceCenter Integration” in *Using Problem Isolation*.

---

# 12

---

## NetScout nGenius Integration

This chapter describes the NetScout nGenius integration.

### **This chapter includes:**

#### Concepts

- ▶ NetScout Integration Overview on page 461

#### Tasks

- ▶ Use the EMS Integration Tool for NetScout Data on page 463

### **NetScout Integration Overview**

This section provides an overview of NetScout and describes the main concepts of the NetScout integration.

#### **Overview of NetScout**

NetScout nGenius monitors network traffic and reports performance metrics about applications routing through that network. NetScout integration shows NetScout alarms in HP Business Availability Center Dashboard. NetScout sends SNMP traps containing information about the alerting instances that could map to existing CI types in the CMDB.

#### **NetScout View and Topology**

NetScout analyzes packets that include information about the applications running through specific routers or switches. When there is a problem, the packets can send in alarms with information about the problematic application.

The SNMP trap for application alarms reports about problems discovered in an application, using information analyzed from packets. The application information is not linked to the router information as the routing path is not constant and may vary depending on network traffic decisions.

The NetScout integration creates the NetScout view. The NetScout view includes CIs that represent the application alarms.

The NetScout view includes the Application CI, the EMS Monitor CI, and their relationship.

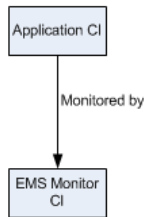

For details about integrating NetScout data in HP Business Availability Center, see “Use the EMS Integration Tool for NetScout Data” on page 463.

All the sample information sent by NetScout is displayed by the **Application** KPIs attached to the **Application Monitor** CIs. The **SiteScope EMS Multiple Events Rule** calculates the statuses of those KPIs based on data obtained from NetScout samples.

The **EMS Show Event** context menu, **Show Events** context menu item, and the **SiteScope EMS Rule** tooltip corresponding to the **SiteScope EMS Multiple Events Rule**, are preconfigured to provide the appropriate infrastructure to work with the NetScout-related CIs in Dashboard. For details about the Application KPI, see “Application” in *CI Attribute Customization*.

For details about:

- ▶ The **SiteScope EMS Multiple Events Rule**, see “SiteScope EMS Multiple Events Rule” in *CI Attribute Customization*.
- ▶ The **EMS Show Event** context menu, see “EMS Show Events” in *CI Attribute Customization*.

- The **Show Events** context menu item, see “Show Events” in *CI Attribute Customization*.
- The **SiteScope EMS Rule** tooltip, see “SiteScope EMS Rule” in *CI Attribute Customization*.

## Use the EMS Integration Tool for NetScout Data

NetScout data can be displayed in HP Business Availability Center using the EMS Integration tool.

For additional information about EMS integration, see “Enterprise Management Systems and the EMS Integrations Application Overview” on page 402.

This task includes the following steps:

- “Prerequisite” on page 463
- “Configure the Integration” on page 464
- “Customize the Integration – Optional” on page 465
- “View NetScout Data in the NetScout View and Enrich the View” on page 465
- “Access the NetScout Application from HP Business Availability Center” on page 465

### 1 Prerequisite

In the NetScout nGenius server, select **Device > Global settings**, and enter, in the Server IP Addresses box, the SiteScope Server IP address of the SiteScope that reports to HP Business Availability Center.

## 2 Configure the Integration

The NetScout integration is predefined. The integration retrieves the samples provided by the NetScout nGenius system, creates the appropriate topology in HP Business Availability Center (application CIs), creates a view, assigns the appropriate KPIs, rules, context menus, context menu items, and tooltips depending on the type of sample and displays the information using the created view.

To configure the NetScout integration, select **Admin > EMS Integrations**, select NetScout and click **Edit**. In the Edit Integration dialog box:

- a** Add the NetScout Event Monitor to a SiteScope monitor group created for this monitor and other Integration Monitor types in **Step 2. Retrieve data from EMS system using System Availability Management**. The monitor is used to retrieve data from the NetScout server using System Availability Management Administration. It is recommended that you configure Integrations Monitors only after a connection between the SiteScope and HP Business Availability Center is established. For details, see “NetScout Event Monitor” in *System Availability Management*.
- b** Activate the Application Monitor CIs data assignment rule in **Step 3. Define the data assignments rules**. The data assignment rule is automatically deactivated, by default. The data assignment rule includes the enrichment rules to create the topology for the Application Monitor CIs.

For details about the enrichment rules, see “Edit Integration Dialog Box” on page 417.

---

**Note:** SiteScope cannot be deployed behind a firewall. SiteScope and the monitored system must be on the same LAN or special firewall configuration might be required.

---



### **3 Customize the Integration – Optional**

You can use the EMS Integrations application to customize a NetScout integration. The integration forwards the retrieved data captured from the NetScout system by the SiteScope NetScout Event Monitor to HP Business Availability Center, and creates the appropriate topology (Application CIs). For details on the available customization, see “Define Assignment Configuration Dialog Box” on page 422.

### **4 View NetScout Data in the NetScout View and Enrich the View**

You can view NetScout application alarms in the NetScout view. For details, see “NetScout View and Topology” on page 461.

To enrich the view, attach IT Universe CIs to the appropriate Application Monitor CIs. For details about attaching KPIs to a CI, see “Attach KPIs to CIs and Configure the KPIs” on page 373.

### **5 Access the NetScout Application from HP Business Availability Center**

From the NetScout view in Dashboard, you can connect to the NetScout application using the **Show Event** right-click menu option on the NetScout EMS monitor CIs. The context menu uses the NetScout server URL included in the samples to perform the drilldown to the NetScout server.



# Part VI

---

## Diagnostics Integration



# 13

---

## HP Diagnostics and HP Business Availability Center Integration

This chapter provides information on the HP Diagnostics and HP Business Availability Center integration.

### **This chapter includes:**

#### Concepts

- ▶ HP Diagnostics and HP Business Availability Center Integration Overview on page 470

#### Tasks

- ▶ Access Online Help for HP Diagnostics in HP Business Availability Center on page 470
- ▶ View HP Diagnostics Data in HP Business Availability Center on page 471

**Troubleshooting and Limitations** on page 472

## **HP Diagnostics and HP Business Availability Center Integration Overview**

HP Diagnostics is a composite application triage and diagnostics solution that is designed to help you improve the performance of your J2EE, .NET, and ERP/CRM enterprise applications throughout the application lifecycle.

HP Diagnostics is integrated with HP Business Availability Center, allowing you to monitor the availability and performance of your production enterprise application. This integration enables you to significantly reduce the Mean Time To Resolution of problems and thus increase the availability and value of the business applications.

From within HP Business Availability Center, you can track the performance status of your applications that are being monitored by HP Diagnostics.

The Diagnostics integration with Business Availability Center allows you to drill down to Diagnostics data from specific Business Availability Center configuration items and reports. You can also generate high level reports in HP Business Availability Center about the performance of applications and Business Process Monitor (BPM) transactions that are monitored by Diagnostics.

## **Access Online Help for HP Diagnostics in HP Business Availability Center**

Click **Help** > **Diagnostics Help** to access the online HP Diagnostics Documentation Library, for the Diagnostics application or for Diagnostics administration in HP Business Availability Center.

## View HP Diagnostics Data in HP Business Availability Center

To view HP Diagnostics data in HP Business Availability Center, you must register the HP Diagnostics server machine in HP Business Availability Center.

### 1 Register HP Diagnostics

Access **Admin > Diagnostics**, to open the HP Diagnostics Server Details page. Enter the details of the server as follows:

- ▶ **Diagnostics server host name.** Enter the name of the machine that is host to the HP Diagnostics Server.  
  
Even when the Diagnostics Server is installed on the same system as HP Business Availability Center you must enter the actual name of the host in the box. Do not enter **localhost**.
- ▶ **Diagnostics server port number.** Accept the default port number (**2006**) or enter the port number through which HP Diagnostics listens to server traffic.
- ▶ **Diagnostics server protocol.** Select the communication protocol (HTTP or HTTPS) through which HP Business Availability Center connects to HP Diagnostics.

If you select HTTPS, additional configuration steps are required. For details, see *HP Diagnostics Installation and Configuration Guide*.

Click **Submit** to register the server with HP Business Availability Center. The Diagnostics Server details are saved in HP Business Availability Center and HP Business Availability Center server details are automatically registered on the HP Diagnostics machine.

If the server name is incorrect or the server is unavailable, an error message is displayed.

If the user name with which you logged in does not have permissions for making changes on the HP Diagnostics server, a message is displayed instead of the HP Diagnostics page.

## 2 Proceed with Setting Up HP Business Availability Center to Work with Diagnostics

For help with the remainder of this procedure for registering the server, see the *HP Diagnostics Installation and Configuration Guide* (select **Help > Diagnostics HP Diagnostics Installation and Configuration Guide**).

## 3 View HP Diagnostics Data in HP Business Availability Center

To view relevant Diagnostics information, select **Application > Dashboard**, select the Diagnostics View in View Explorer and click the appropriate tab.

For information on the HP Diagnostics data displayed in HP Business Availability Center, see the *HP Diagnostics User's Guide* (select **Help > Diagnostics Help > HP Diagnostics User's Guide**).

## 4 Access HP Diagnostics from HP Business Availability Center

You can access HP Diagnostics from HP Business Availability Center using right-click options in views and drill-downs from some reports.

## Troubleshooting and Limitations

**Problem:** After connecting HP Business Availability Center to the HP Diagnostics server, a message is displayed: "Session does not exist."

**Solution:** Check that Internet Explorer is set up to allow the browser to submit cookies to the HP Diagnostics server.

**To set up Internet Explorer to allow the browser to submit cookies:**

- 1 In Internet Explorer (version 6.0), select **Tools > Internet Options > Privacy**.
- 2 In the Web Sites section, click the **Edit** button.
- 3 In the Per Site Privacy Actions dialog box, enter the HP Diagnostics server DNS domain name.
- 4 Click **Allow**, **OK**, and **OK**.



# Part VII

---

## Application Performance Lifecycle



# 14

---

## Application Performance Lifecycle

Application Performance Lifecycle is designed to integrate between HP Business Availability Center and HP Performance Center, enabling you to construct load tests based on real-user transaction data collected by the Real User Monitor.

### **This chapter includes:**

#### **Concepts**

- Application Performance Lifecycle Overview on page 476
- Application Performance Lifecycle Reports on page 476

#### **Tasks**

- Application Performance Lifecycle Workflow on page 480
- Analyze the Business Process Distribution Report on page 481
- Replay a Session on page 484
- Generate a Script Template on page 485
- Analyze a Typical Transaction Load Report on page 486
- Analyze the Location Load Analysis Report on page 488
- Use Application Performance Lifecycle Reports – A Case Scenario on page 489
- Refine Your Script Template in VuGen on page 492
- Configure and Run a Load Test on page 496
- Work with the Central Repository Service (CRS) on page 501

#### **Reference**

- Application Performance Lifecycle User Interface on page 505

## Application Performance Lifecycle Overview

Application Performance Lifecycle enables quality assurance engineers to design load tests based on data leveraged from a production environment, rather than a testing environment. Using Application Performance Lifecycle, the QA engineer can construct load tests that are based on real-user transaction data and are therefore a more accurate simulation of load than standard Performance Center load tests. Application Performance Lifecycle thus increases the effectiveness of load tests and provides the QA team with more accurate test results.

To achieve this goal, Application Performance Lifecycle provides the following:

- ▶ Production Analysis reports from which the QA engineer can extract real-user transaction data to be used in Performance Center load tests
- ▶ The ability to create Virtual User Generator (VuGen) script templates, based on real-user activity

## Application Performance Lifecycle Reports

Use Application Performance Lifecycle Production Analysis reports to pinpoint data that you want to use in building your Performance Center load test.

This section includes the following topics:

- ▶ “Business Process Distribution Report” on page 477
- ▶ “Typical Transaction Load Report” on page 478
- ▶ “Location Load Analysis Report” on page 479

## Business Process Distribution Report

The report enables you to view transaction run and transaction response time data over time for the configured transactions monitored by the Real User Monitor, create VuGen script templates that can be used in a Performance Center load test. You can create a VuGen script template either by instructing Application Performance Lifecycle to automatically generate a script template based on a session it selects, or by manually selecting the specific session you want to include in your script template.

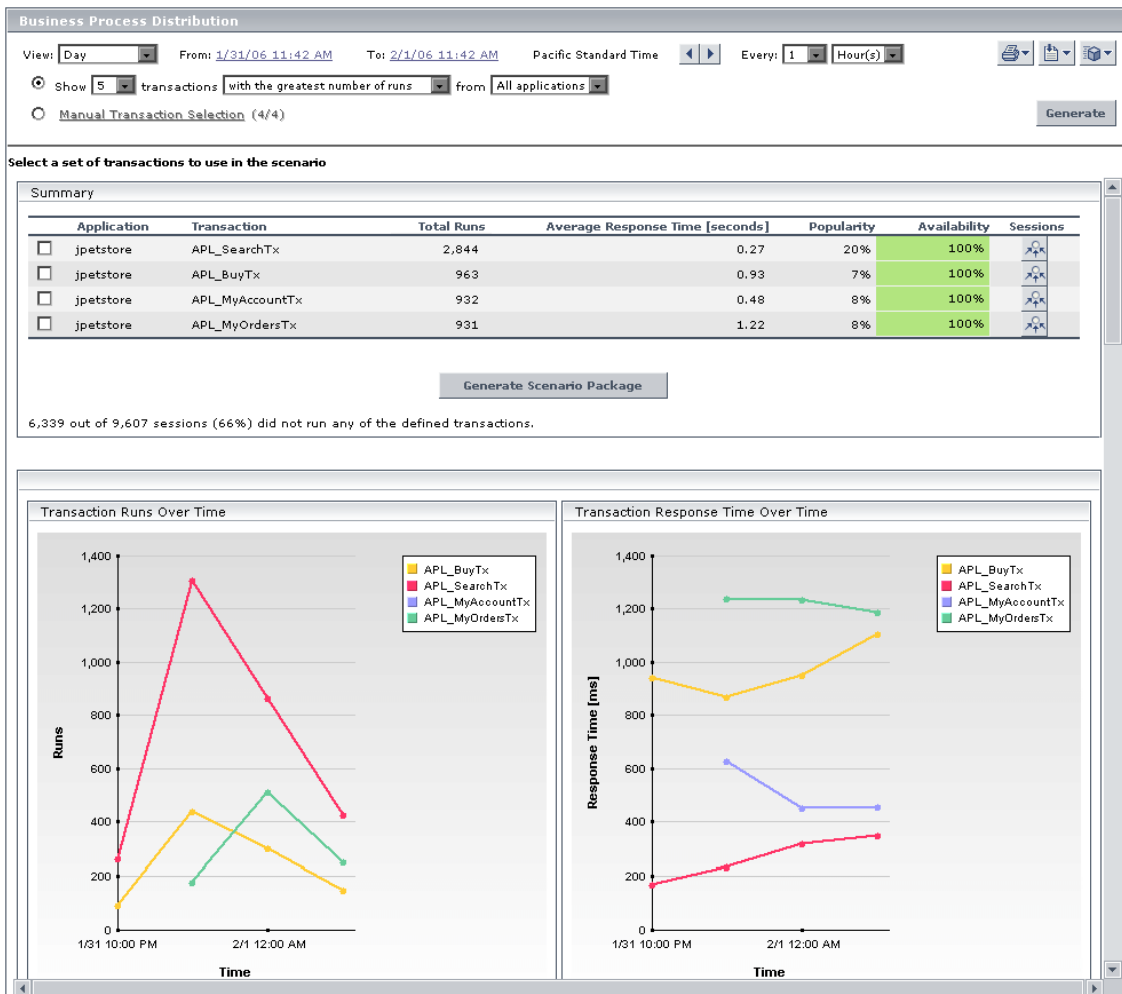

For details, see “Business Process Distribution Page” on page 506.

## Typical Transaction Load Report

This report enables you to view the average transaction load (the number of Real User Monitor transaction runs) during a typical hour, day, or week within a larger time frame that you select. Use the data in this report to:

- View the typical load on your system during specific time frames, which can assist you in determining the time frame you want to use for your Performance Center load test.
- Assist you, together with the data in the Business Process Distribution report, in selecting the transactions to include in your VuGen script templates.

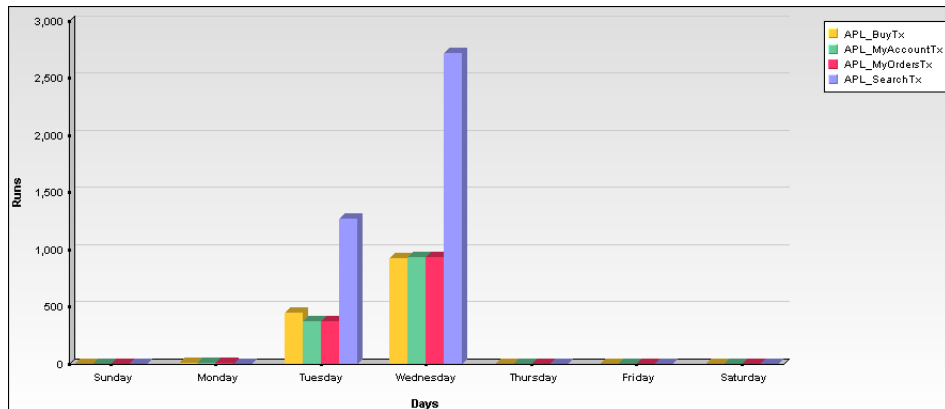

Transaction ^	Monday	Tuesday	Wednesday	Average
APL_BuyTx	3.00	441.00	920.00	454.67
APL_MyAccountTx	1.00	368.00	932.00	433.67
APL_MyOrdersTx	1.00	366.00	931.00	432.67
APL_SearchTx	0.00	1,270.00	2,713.00	1,327.67
<b>Average</b>	<b>1.25</b>	<b>611.25</b>	<b>1,374.00</b>	<b>662.17</b>

For details, see “Typical Transaction Load Report” on page 517.

## Location Load Analysis Report

This report enables you to view the transaction load (the number of Real User Monitor transaction runs) and bit rate (bits per second) per end-user location.

Use the data in this report in configuring Vusers and load generators for your Performance Center load test, as well as the run-time settings for your Application Performance Lifecycle-generated VuGen script.

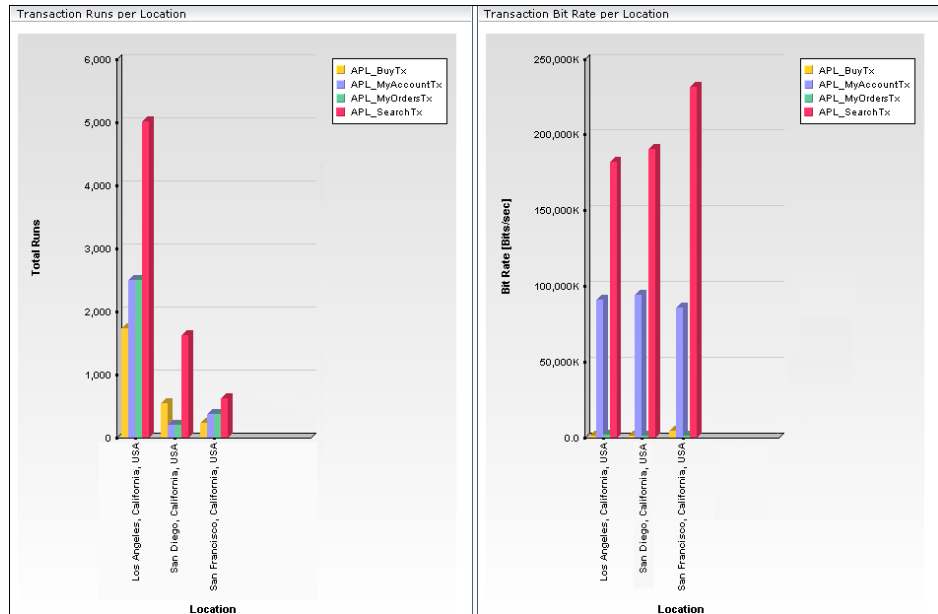

Location	APL_BuyTx		APL_MyAccountTx		APL_SearchTx		APL_MyOrdersTx		Average	
	Bitrate [Bits/sec]	Total Runs	Bitrate [Bits/sec]	Total Runs	Bitrate [Bits/sec]	Total Runs	Bitrate [Bits/sec]	Total Runs	Bitrate [Bits/sec]	Runs
Los Angeles, California, USA	986,926.51	1,728	90,733,629.8	2,488	182,127,139.43	5,014	1,465,535.36	2,486	68,828,307.78	2,929
San Diego, California, USA	837,160.62	539	93,903,525.33	192	190,291,022.63	1,613	1,044,494.71	192	71,519,050.82	634
San Francisco, California, USA	4,077,468.05	224	85,439,809.74	369	231,718,670.75	614	1,001,510.73	367	80,559,364.82	393.5
Average	1,967,185.06	830.33	90,025,654.95	1,016.33	201,378,944.27	2,413.67	1,170,513.6	1,015	73,635,574.47	1,318.83

For details, see “Location Load Analysis Report” on page 512.

## Application Performance Lifecycle Workflow

Working with Application Performance Lifecycle involves performing the following procedures:

- ▶ “Configure Real User Monitor Transactions and Schedule the Snapshot Collection” on page 480
- ▶ “Analyze Production Analysis Reports” on page 480
- ▶ “Refine Script Templates” on page 480
- ▶ “Setup and Run a Load Test or Scenario That Includes the Scripts” on page 481

### **1 Configure Real User Monitor Transactions and Schedule the Snapshot Collection**

Ensure that Real User Monitor transactions are defined and that a transaction snapshot collection schedule is configured.

For details on configuring Real User Monitor transactions, see “New/Edit Transaction Page” in *Using End User Management*. For details on configuring a transaction snapshot collection schedule, see “New/Edit Web or SOAP Application Page” in *Using End User Management*.

### **2 Analyze Production Analysis Reports**

In the Production Analysis reports, analyze production performance data, export the data you want to use when building a Performance Center load test, select the real-user transactions and sessions you want to use in your VuGen scripts, and generate script templates.

For details, see “Application Performance Lifecycle User Interface” on page 505.

### **3 Refine Script Templates**

In VuGen, adjust the scripts generated by Application Performance Lifecycle for use in a Performance Center load test.

For details, see “Refine Your Script Template in VuGen” on page 492.



## 4 Setup and Run a Load Test or Scenario That Includes the Scripts

In Performance Center or LoadRunner, set up and run a load test or scenario that incorporates the scripts you created and refined and emulates the real-user behavior displayed in the Production Analysis reports.

For details, see “Configure and Run a Load Test” on page 496.

## Analyze the Business Process Distribution Report

You use the Business Process Distribution report to pinpoint the Real User Monitor transactions with the greatest number of runs and the highest session popularity. You then drill down in this report to view the individual sessions in which these transactions were run. You can also use the Business Process Distribution report to pinpoint the transactions that were problematic in terms of response time and availability and drill down so that you can isolate the sessions, and pages within the sessions, that were problematic.

You select a session—either one that was popular and contained a large number of transaction runs, or one that was problematic in terms of response time or availability—as the basis for your VuGen script template. Alternatively, you can select transactions from the Business Process Distribution report and instruct Application Performance Lifecycle to automatically select a session for each transaction and generate a VuGen script template based on this session. For each transaction, Application Performance Lifecycle selects the session with a combination of the greatest number of runs, the shortest duration, and the least number of errors.

---

**Note:** You can use this report in conjunction with the Typical Transaction Load report to ensure that the transactions you select reflect typical transaction behavior during the selected time period. For details of a case scenario describing the use of the Business Process Distribution report in conjunction with the Typical Transaction Load report, see “Use Application Performance Lifecycle Reports – A Case Scenario” on page 489.

---

To analyze the Business Process Distribution report, access the Business Process Distribution report. For details, see “Business Process Distribution Page” on page 506.

### Example

- 1 Access the Business Process Distribution report, select a transaction, based on the total number of runs for the transaction as well as the transaction’s session popularity (or response time/availability data), and click the **View Sessions** button to open the Sessions page. It displays data for each session in which the selected transaction was run and a transaction snapshot was collected, as well as certain key statistic averages of all the displayed sessions. For additional information on the Sessions page, see “Session Analyzer Report” in *Using End User Management*.

Select a session to use for script template generation

Session Statistics - Averages						
Session duration [hh:mm:ss]:	00:00:18	HTTP errors:	0.0			
Application errors:	0.0	Total pages:	11.554			

Sessions Containing Snapshots for All Pages						
User name	Start time	Session duration [hh:mm:ss]	Application errors	HTTP errors	Total pages	Details
192.168.83.87	2/1/06 1:35 AM	00:00:06	0	0	9	
192.168.83.87	2/1/06 1:35 AM	00:00:03	0	0	9	
192.168.83.87	2/1/06 1:35 AM	00:00:02	0	0	9	
192.168.83.87	2/1/06 1:35 AM	00:00:05	0	0	9	
192.168.83.87	2/1/06 1:35 AM	00:00:07	0	0	9	
192.168.83.87	2/1/06 1:35 AM	00:00:07	0	0	9	
192.168.83.87	2/1/06 1:34 AM	00:00:04	0	0	9	
192.168.83.87	2/1/06 1:28 AM	00:00:07	0	0	10	
192.168.83.87	2/1/06 1:28 AM	00:00:04	0	0	9	
192.168.83.87	2/1/06 1:28 AM	00:00:06	0	0	10	
192.168.83.87	2/1/06 1:28 AM	00:00:07	0	0	9	
192.168.83.87	2/1/06 1:28 AM	00:00:03	0	0	9	
192.168.83.87	2/1/06 1:27 AM	00:00:06	0	0	9	
192.168.83.87	2/1/06 1:27 AM	00:00:03	0	0	9	
192.168.83.87	2/1/06 1:27 AM	00:00:01	0	0	8	
192.168.83.87	2/1/06 1:21 AM	00:00:05	0	0	9	
192.168.83.87	2/1/06 1:21 AM	00:00:08	0	0	10	
192.168.83.87	2/1/06 1:21 AM	00:00:03	0	0	9	
192.168.83.87	2/1/06 1:20 AM	00:00:05	0	0	9	

- 2 Select the session you want to use for your VuGen script, based on page hit and error data, and click the **View Session Details** button. The Session Details page opens, displaying general session and event information, as well a list of all the pages accessed as part of the session and the events and response time for each page. The pages that were included in the selected transaction's definition are highlighted.

Properties

<b>Start time:</b> 2/1/06 1:28 AM	<b>End user group:</b> RnD
<b>Overall traffic [KB]:</b> 186.82	<b>IP address:</b> 192.168.83.87
<b>Duration [hh:mm:ss]:</b> 00:00:07	<b>Host name:</b> brake.global.com
<b>Operating system:</b> Windows	<b>User name:</b> N/A
<b>Browser:</b> Internet Explorer 6.0	<b>Server IP:</b> 192.168.83.56
<b>Location:</b> USA, California, Los Angeles	<b>Arrived from:</b> http://casanova:8080/jpetstore/

---

Pages

Start time ▲	Page	Events	Response time [seconds]
2/1/06 01:28:23 AM	jpt-index	-	1.81
2/1/06 01:28:25 AM	jpt-signonform	-	0.18
2/1/06 01:28:29 AM	http://linux-probe:8080/jpetstore/shop/signon.shtml	-	0.05
2/1/06 01:28:29 AM	jpt-view-category	-	0.22
2/1/06 01:28:29 AM	jpt-view-product	-	0.26
2/1/06 01:28:30 AM	jpt-view-item	-	0.02
2/1/06 01:28:30 AM	jpt-add2cart	-	0.01
2/1/06 01:28:30 AM	jpt-checkout	-	0.03
2/1/06 01:28:30 AM	jpt-new-order-form	-	0.01
2/1/06 01:28:30 AM	jpt-signed-out	-	0.01

**Note:** Event data is displayed only if you configured events for the application with which the transaction you are viewing is associated. For information on events and their configuration, see “Real User Monitor Administration” in *Using End User Management*.

For additional information on the Session Details page, see “Session Details Report” in *Using End User Management*.

## **Replay a Session**



To replay a session page by page in your Web browser, in the Session Details page (which you access by clicking the **View Sessions** button for a selected transaction in the **Business Process Distribution** report), click **Session Replay**. The **Session Viewer** window opens, displaying three panes.



The upper-left pane displays a hierarchical tree of the pages included in the session, and their components. There is also an entry for the session details. Click on the item in the tree you want to view. Page and component names that are preceded by a camera icon, are pages and components for which snapshots exist.

The lower-left pane displays general details of the selected page or component, or details of the session if **Session Details** is selected in the upper-left pane.

The right-hand pane includes the following tabs:

- ▶ **Snapshot View.** Displays a picture of the page accessed by the user.
- ▶ **Page Source.** Displays the HTML source code of the snapshot.
- ▶ **Events.** Displays the configured events that occurred on the page.

---

**Note:** If Session Details is selected for viewing, only the Events tab is enabled.

---



To download all the snapshots included in a session to a zip file, click the **Download** button above the left pane. The **Save** dialog box opens. Select the path and file name you want and click **Save**. The saved zip file includes a Java applet for viewing the saved information.

---

**Note:** If the snapshot requested is one of an HTTP Not Found error (HTTP error code 404), in some instances the link to the referring machine is to an HP Business Availability Center server machine instead of to the original Web server machine that reported the error. This is due to an html script that generates a link being stored in the snapshot, rather than the actual link itself.

---

## **Generate a Script Template**

From the Session Details page, you click **Generate Script Template** to generate a template for your VuGen script that includes the pages in the current session. If you have enabled the CRS on the Infrastructure Settings Manager page, you are prompted to save the script template in the repository. For details on enabling the CRS and saving scripts in the repository, see “Save a Script Template or Scenario Package in the CRS” on page 502. If the CRS is not enabled, you are prompted to save the script template in your regular directory structure.

You should generate a script template for each transaction you would like to include in your Performance Center load test.

---

**Tip:** Save all your script templates in the same directory so that they are all easily accessible when constructing a Performance Center load test.

---

## Analyze a Typical Transaction Load Report

You use the Typical Transaction Load report to view the average transaction load during a typical week, day, or hour. In general, you use the Typical Transaction Load report, and the ability to drill down within this report, to pinpoint the time frame you want to use for your Performance Center load test.

### Example

If you selected to view a typical week during the past month, the Typical Transaction Load report may display data such as the following.

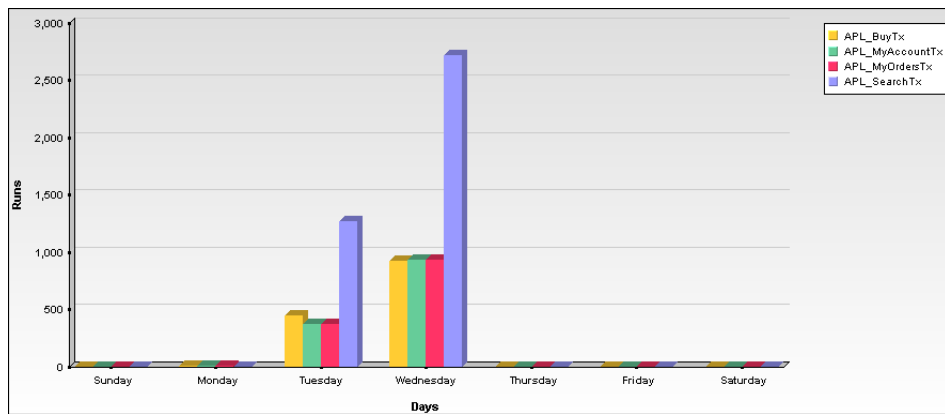

Since Wednesday is typically the day with the greatest number of transaction runs, you would choose to run your load test on a Wednesday. To view the specific hours on Wednesday at which transaction load was typically at its peak, click one of the bars in the Wednesday column. The Typical Transaction Load graph displays the typical load for each hour on Wednesday.

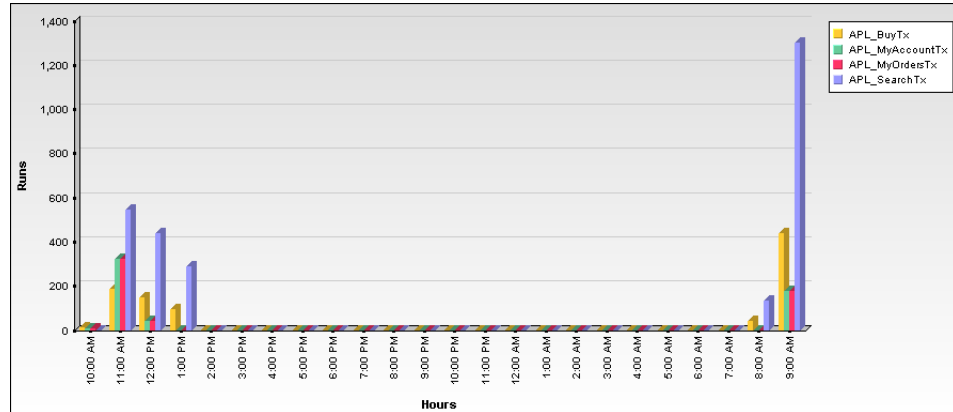

Since load is typically greatest at 9:00 AM or 11:00 AM, you would choose to run your load test during this time range. You can also drill down to view the minutes during which transaction load was typically at its peak, however this data is less relevant for the construction of a load test than the typical daily and hourly data.

---

**Note:** You can also use this report in conjunction with the Business Process Distribution report to determine whether a large number of runs displayed for a transaction in the Business Process Distribution report is typical of the transaction's behavior during the selected time period. If the Typical Transaction Load report indicates that the transaction load displayed in the Business Process Distribution report is typical of the transaction's load during the selected time period, it is recommended that you use the transaction for your VuGen script.

---

## Analyze the Location Load Analysis Report

You use the Location Load Analysis report to view the distribution of Real User Monitor transaction runs among end-user locations, as well as the bit rate of each transaction at each location. You then use the location data in selecting load generators, the transaction run data in distributing Vusers among load generators, and the bit rate data in configuring each script's network speed simulation settings.

### Example

For example, if you selected to view location data for four transactions—**APL\_BuyTx**, **APL\_MyAccountTx**, **APL\_SearchTx**, and **APL\_MyOrdersTx**—during the past month, the Location Load Analysis report may display data such as the following.

Location <sup>a</sup>	APL_BuyTx		APL_MyAccountTx		APL_SearchTx		APL_MyOrdersTx		Average	
	Bitrate [Bits/sec]	Total Runs	Bitrate [Bits/sec]	Total Runs	Bitrate [Bits/sec]	Total Runs	Bitrate [Bits/sec]	Total Runs	Bitrate [Bits/sec]	Runs
Los Angeles, California, USA	986,926.51	1,728	90,733,629.8	2,488	182,127,139.43	5,014	1,465,535.36	2,486	68,828,307.78	2,929
San Diego, California, USA	837,160.62	539	93,903,525.33	192	190,291,022.63	1,613	1,044,494.71	192	71,519,050.82	634
San Francisco, California, USA	4,077,468.05	224	85,439,809.74	369	231,718,670.75	614	1,001,510.73	367	80,559,364.82	393.5
Average	1,967,185.06	830.33	90,025,654.95	1,016.33	201,378,944.27	2,413.67	1,170,513.6	1,015	73,635,574.47	1,318.83

Based on this report, you may choose to select load generators from one or more of the above locations when configuring your load test. Your distribution of Vusers among the load generators would most likely be based on the distribution of transaction load (that is, the number of transaction runs being run) among the above locations. For an explanation of configuring load tests based on Production Analysis report data, see “Configure and Run a Load Test” on page 496.

In addition, you would use the bit rate data in this report in configuring the Network: Speed Simulation VuGen run-time settings of the Application Performance Lifecycle-generated scripts that you are using for your load test. For example, if you generated a script based on the **APL\_SearchTx** transaction and planned to run this script from two load generators—one located in Los Angeles and the other in San Francisco—you would do the following:

- create two copies of the script;
- set the custom bandwidth for the script being run from Los Angeles at 182,127,139 bits per second;



- set the custom bandwidth for the script being run from San Francisco at 231,718,670 bits per second.

For details on configuring Application Performance Lifecycle-generated scripts based on data from the Location Load Analysis report, see the **Set the Speed Simulation** step in “Refine Your Script Template in VuGen” on page 492.

## Use Application Performance Lifecycle Reports – A Case Scenario

This section describes a typical case scenario in which a user worked with all three Application Performance Lifecycle reports to obtain the information he required to construct a Performance Center load test.

Initially, the user accessed the Business Process Distribution report to view data for the five transactions with the greatest number of run instances during the period of a week, from January 26, 2006 to February 2, 2006. The Business Process Distribution report showed that **APL\_SearchTx** was the transaction with the greatest number of runs—a total of 4,114 transaction runs—as well the most popular transaction (run in 18% of the sessions).

Application	Transaction	Total Runs	Average Response Time [seconds]	Popularity	Availability	Sessions
jpetstore	APL_SearchTx	4,114	0.25	18%	100%	

To verify that this data reflected the typical transaction load for the **APL\_SearchTx** transaction during this time period, the user accessed the Typical Transaction Load report and viewed data for a typical week during the monthly period of January 2, 2006 to February 2, 2006. The Typical Transaction Load report showed that the average transaction load for the **APL\_SearchTx** transaction was indeed significant during this period of time.

Transaction	Monday	Tuesday	Wednesday	Average
APL_SearchTx	0.00	1,270.00	2,713.00	1,327.67

The user then drilled down further in the Typical Transaction Load report to discover the specific hours on Wednesday (the day with the greatest number of transaction runs) during which transaction load was typically at its peak.

Transaction	10:00 AM	11:00 AM	12:00 PM	1:00 PM	8:00 AM	9:00 AM	Average
APL_SearchTx	0.00	544.00	440.00	286.00	131.00	1,300.00	450.17

The drilldown showed that load was typically greatest at 9:00 AM, so the user decided that he would later run his load test at this hour. To be able to use this data as well as the average transaction run data later on, when configuring a load test, the user saved the report in .PDF format.

Having received confirmation of the significance of the **APL\_SearchTx** transaction, the user returned to the Business Process Distribution report to generate a VuGen script of a session in which the **APL\_SearchTx** transaction was run. To view the sessions in which **APL\_SearchTx** was run and a transaction snapshot was collected, the user clicked the **View Sessions** button. After viewing error and page hit data for each displayed session, the user selected to view details of a session with 1 application error, 1 HTTP error, and 13 page hits.



User name	Start time	Session duration [hh:mm:ss]	Application errors	HTTP errors	Total pages	Details
192.168.83.87	2/1/06 1:13 AM	00:00:21	1	1	13	

The user then clicked the **View Session Details** button to view details of the end user that ran the selected session, as well as the pages that were accessed as part of the session (with those included in the transaction highlighted).

Start time	Page	Events	Response time [seconds]
2/1/06 01:13:21 AM	jpt-index	-	0.08
2/1/06 01:13:21 AM	jpt-signonform	-	0.14
2/1/06 01:13:25 AM	http://linux-probe:8080/jpetstore/shop/signon.shtml	-	0.01
2/1/06 01:13:27 AM	jpt-view-category	-	0.02
2/1/06 01:13:27 AM	jpt-view-product	-	0.01
2/1/06 01:13:29 AM	jpt-view-item	-	9.42
2/1/06 01:13:39 AM	jpt-add2cart	-	0.05
2/1/06 01:13:39 AM	jpt-checkout	-	0.03
2/1/06 01:13:39 AM	jpt-new-order-form	-	0.19
2/1/06 01:13:39 AM	jpt-ordered	-	0.05
2/1/06 01:13:39 AM	jpt-ordered	-	2.63
2/1/06 01:13:42 AM	jpt-signed-out	-	0.05

After viewing all of this data, the Application Performance Lifecycle user decided to use this session as the basis for a VuGen script and clicked **Generate Script Template** on the Session Details page to Application Performance Lifecycle to create a script template from the session. The user saved the generated script to the CRS.

To prepare additional data for the configuration of his load test, the user accessed the Location Load Analysis report and selected to view location data for the **APL\_SearchTx** transaction. The Location Load Analysis report showed that end users at three locations—Los Angeles, San Diego, and San Francisco—ran the **APL\_SearchTx** transaction.

APL_SearchTx		
Location ▲	Bit Rate [Bits/sec]	Total Runs
Los Angeles, California, USA	222,267,206.3	1,887
San Diego, California, USA	190,291,022.63	1,613
San Francisco, California, USA	231,718,670.75	614
<b>Average</b>	<b>214,758,966.56</b>	<b>822.8</b>

To be able to use this data for his Performance Center load test, the user saved the Location Load Analysis report in .PDF format.

Based on this report, the user decided to run the script he generated from three different load generators, each located at one of the above locations. To do so, the user created three different copies of the script and set the Network: Speed Simulation VuGen run-time settings for each script according to the bit rate for the location from which the script was going to be run (for details, see “Set the Speed Simulation” on page 495). The user also based his distribution of Vusers among the load generators on the distribution of total runs among the above locations. (For details on configuring load tests, see “Configure and Run a Load Test” on page 496.)

---

**Note:** The above case scenario describes the generation of one script, based on one transaction, however a true use case typically includes several scripts, based on several different transactions.

---

## Refine Your Script Template in VuGen

To use Application Performance Lifecycle-generated scripts in a Performance Center load test, you must first customize them using VuGen.

---

**Note:** If you exported the script templates you created in Application Performance Lifecycle to the CRS, see “Open a Script Saved in the CRS” on page 503 for details on how to open the script templates in VuGen.

---

This task includes the following steps:

- “Parameterize Recorded Values” on page 493
- “Correlate Recorded Values” on page 494
- “Set the Speed Simulation” on page 495

## 1 Parameterize Recorded Values

When you generate a script using Application Performance Lifecycle, the script contains the actual end-user values that the Real User Monitor recorded. To perform the script's actions (query, submit, and so on) using different values from those recorded by the Real User Monitor, you must replace the values with parameters.

### Example

Suppose you generated a script containing the following statement that searches a library's database for the title **UNIX**:

```
web_submit_form("db2net.exe",
  ITEMDATA,
  "name=library.TITLE",
  "value=UNIX",
  ENDITEM,
  "name=library.AUTHOR",
  "value=",
  ENDITEM,
  "name=library.SUBJECT",
  "value=",
  ENDITEM,
  LAST);
;
```

When you run this script in a Performance Center load test, you do not want to repeatedly use the same value, **UNIX**. You therefore replace the constant value with a parameter:

```
web_submit_form("db2net.exe",
  ITEMDATA,
  "name=library.TITLE",
  "value={Book_Title}",
  ENDITEM,
  "name=library.AUTHOR",
  "value=",
  ENDITEM,
  "name=library.SUBJECT",
  "value=",
  ENDITEM,
  LAST);
```

When you run a load test using a parameterized script, Vusers substitute the parameter with different values from a data source that you specify. The data source can be either a file or internally generated variables.

For detailed instructions on replacing the constant values in your generated script with parameters, as well as setting the properties and data source for these parameters, see *HP Virtual User Generator User's Guide*.

---

Notes:

- ▶ You can parameterize complete strings or parts of strings.
  - ▶ You can define more than one parameter for functions with multiple arguments (such as URLs, server names, and IP addresses).
- 

## 2 Correlate Recorded Values

In addition to parameterizing the script you generated using Application Performance Lifecycle, you must correlate certain statements within the script. Correlation allows you to link statements by using the results of one statement as input for another.

You correlate statements for one or both of the following reasons:

- ▶ to generate dynamic data – For example, if the Real User Monitor session from which you generated your script was identified by the date and time, when you try to replay a script of this session, it fails because the current time is different than the original recorded time. Only if you correlate the date and time can you save it as dynamic data and use it throughout the load test or session step run.
- ▶ to accommodate unique data records – For example, if the Real User Monitor recorded a session requiring the use of unique values, such as the process of opening a new bank account, replaying a script of the session fails because the recorded value already exists and cannot be recreated. Correlating the value enables you to create additional unique values—based on the recorded value—to be used throughout the load test or session step run.

For detailed instructions on correlating a script, see *HP Virtual User Generator User's Guide*.

### 3 Set the Speed Simulation

You set the speed simulation for your Application Performance Lifecycle-generated script based on data contained in the Location Load Analysis report.

**To set the speed simulation for a script:**

- a** In VuGen, select **Vuser > Run-Time Settings** or click the **Run-Time Settings** button on the toolbar to open the Run-Time Settings dialog box.
- b** In the Run-Time Settings tree, select the **Network: Speed Simulation** node.

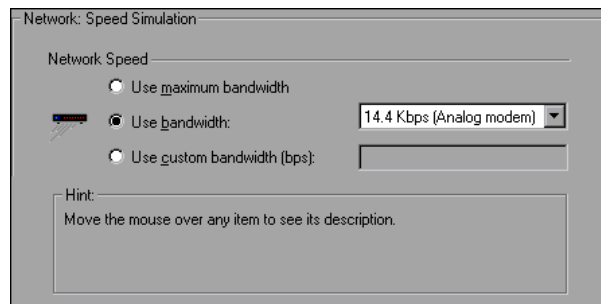

- c** Select **Use custom bandwidth** and specify the bit rate of the location from which you want to run the script, according to the bit rate displayed for this location (for the transaction upon which the script is based) in the Location Load Analysis report. For example, if the transaction upon which your script is based was run by a significant number of users in Los Angeles, California, you would specify the bit rate displayed for Los Angeles in the Location Load Analysis report's Transaction Bit Rate Per Location graph.

---

**Note:** To run the same script from several different locations, you can save several copies of the script and assign each copy a custom bandwidth reflecting the bit rate of a specific location. For details on assigning load generators to each copy of the script, see “Configure and Run a Load Test” on page 496.

---

- d Click **OK** to apply the updated run-time settings.

## **Configure and Run a Load Test**

This section describes how to configure and run Performance Center and LoadRunner load tests that incorporate the scripts you created using Application Performance Lifecycle and emulate the real-user behavior displayed in the Production Analysis reports.

This task includes the following steps:

- “Configure and Run a Load Test in Performance Center” on page 496
- “Configure and Run a Scenario in LoadRunner” on page 498

### **1 Configure and Run a Load Test in Performance Center**

After you have refined your Application Performance Lifecycle-generated scripts using VuGen, you can create a load test in Performance Center that incorporates these scripts and emulates the real-user behavior displayed in the Production Analysis reports.

This section describes how to incorporate the Application Performance Lifecycle-generated scripts and Production Analysis report data in designing a load test. For detailed instructions on creating a load test, see the *HP Performance Center User’s Guide*.



**To incorporate Application Performance Lifecycle-generated scripts in a load test:**

Connect VuGen to the Performance Center Web server and either upload your script files directly to the Performance Center Web server or save them in the file system. For detailed instructions, see *HP Virtual User Generator User's Guide*.

If you saved the Application Performance Lifecycle-generated scripts in the CRS, see “Upload Scripts from the CRS to Performance Center” on page 504 for details on uploading the scripts to the Performance Center Web server.

**To incorporate the Production Analysis report data in a load test:**

- a** Access the Business Process Distribution, Typical Transaction Load, and Location Load Analysis reports that you printed, emailed, or saved while working with the Production Analysis reports. For details on retrieving a report from the CRS, see “Retrieve a Report Saved in the CRS” on page 504.
- b** In Performance Center, select **Load Tests > Create/Edit** from the left menu to open the Load Tests page.
- c** Click **New Load Test** to create a new load test.
- d** In the **Design Groups** tab, select the scripts you generated using Application Performance Lifecycle and customized in VuGen. Select one or more load generators to run each script, based on the location data in the Location Load Analysis report. For example, if the transaction upon which one of your scripts is based was run from Los Angeles, California, you would select one or more load generators located in Los Angeles to run this particular script.

---

**Note:** Ensure that the Network: Speed Simulation run-time settings of each script are set to match the bit rate specified in the Location Load Analysis report for the location from which the script is being run. For details on configuring Network: Speed Simulation run-time settings, see “Set the Speed Simulation” on page 495.

---

- e** Distribute the Vusers among the Vuser groups based on the distribution of transaction load among the locations displayed in the Location Load Analysis report, represented by the load generators you selected for each group. For example, if the transactions upon which your scripts are based were run from three locations and each location ran approximately one third of the transactions, you would distribute the Vusers evenly among the Vuser groups.
- f** The overall number of Vusers for your load test should be based on the average transaction run data in the Typical Transaction Load report. In specifying the number of Vusers to run, however, ensure that you take into account the difference in scaling between load test and production environments.
- g** In the **Scheduler** tab, configure the Ramp Up and Ramp Down of Vusers based on data in the Typical Transaction Load report. For example, if the Typical Transaction Load report showed that an average of 100 transactions were run at the beginning of the time period you selected to use for your load test and 80 transactions were run at the end of this time period, you might configure your load test to start 100 Vusers every hour and stop 80 Vusers every hour. Note, however, that you must take into account the difference in scaling between load test and production environments.
- h** Complete your load test configuration and run the load test from the Load Tests Configuration page by clicking **Start**, or from the Load Tests page by clicking the **Run Test** icon in the row of the load test that you want to run. For details on configuring and running a load test, see the *HP Performance Center User's Guide*.

## 2 Configure and Run a Scenario in LoadRunner

After you have refined your Application Performance Lifecycle-generated scripts using VuGen, you can create a manual scenario in the LoadRunner Controller that incorporates these scripts and emulates the real-user behavior displayed in the Production Analysis reports.

This section describes how to incorporate the Application Performance Lifecycle-generated scripts and Production Analysis report data in designing a manual scenario. For detailed instructions on creating a manual scenario, see the *HP LoadRunner Controller User's Guide*.

**To incorporate Application Performance Lifecycle-generated scripts in a scenario:**

- a** In the New Scenario dialog box, choose **Manual Scenario**. Do not select the **Use the Percentage Mode** check box.
- b** Click the **Browse** button, navigate to the directory in which you saved the Application Performance Lifecycle-generated scripts that you modified using VuGen, and select the scripts.
- c** If these scripts are saved in the CRS, see “Open a Script Saved in the CRS” on page 503 for details on selecting them.
- d** Click the **Add** button to add the scripts to your scenario.

**To incorporate the Production Analysis report data in a scenario:**

- a** Access the Business Process Distribution, Typical Transaction Load, and Location Load Analysis reports that you printed, emailed, or saved while working with the Production Analysis reports. For details on retrieving a report from the CRS, see “Retrieve a Report Saved in the CRS” on page 504.
- b** In LoadRunner, to the right of the Scenario Groups pane, click the **Add Group** button. Select a script you generated using Application Performance Lifecycle and customized in VuGen. Select one or more load generators to run the script, based on the Location Load Analysis report’s location data for the transaction upon which the script is based. For example, if the transaction upon which one a script is based was run from Los Angeles, California, you would select one or more load generators located in Los Angeles to run this script.

---

**Note:** Ensure that the Network: Speed Simulation run-time settings of the script are set to match the bit rate specified in the Location Load Analysis report for the location from which the script is being run. For details on configuring Network: Speed Simulation run-time settings, see “Set the Speed Simulation” on page 495.

---

Select a quantity of Vusers for the group. Vusers should be distributed among Vuser groups based on the distribution of transaction load among the locations displayed in the Location Load Analysis report, represented by the load generators you selected for each group. For example, if the transactions upon which your scripts are based were run from three locations and each location ran approximately one third of the transactions, you would distribute the Vusers evenly among the Vuser groups.

The overall number of Vusers for your scenario should be based on the average transaction run data in the Typical Transaction Load report. In specifying the number of Vusers, however, ensure that you take into account the difference in scaling between load test and production environments.

---

**Note:** You use the Add Group dialog box to add each Application Performance Lifecycle-generated script you want to include in your scenario. Since each location requires specific script network run-time settings, each location requires its own unique script. For details on preparing a script to be run from each location, see “Set the Speed Simulation” on page 495.

---

- c** In the Schedule Builder, configure the Ramp Up and Ramp Down of Vusers based on data in the Typical Transaction Load report. For example, if the Typical Transaction Load report showed that an average of 100 transactions were run at the beginning of the time period you selected to use for your load test and 80 transactions were run at the end of this time period, you might configure your load test to start 100 Vusers every hour and stop 80 Vusers every hour. Note, however, that you must take into account the difference in scaling between load test and production environments.
- d** Complete your scenario configuration and run the scenario from the Run tab of the Controller. For details on configuring and running a scenario, see the *HP LoadRunner Controller User's Guide*.

## Work with the Central Repository Service (CRS)

This section describes how to export Production Analysis reports to the CRS, generate a script template or scenario package and save it in the CRS, open scripts saved in the CRS, retrieve reports saved in the CRS, and upload scripts saved in the CRS to Performance Center.

When working with the Central Repository Service, you are only able to see the folders in the Central Repository Service for which you, the logged-in user, have permissions to view. For details on setting permissions for the Central Repository Service, see “Central Repository Service Permissions” in *Platform Administration*.

This task includes the following steps:

- ▶ “Export a Report to the CRS” on page 501
- ▶ “Save a Script Template or Scenario Package in the CRS” on page 502
- ▶ “Open a Script Saved in the CRS” on page 503
- ▶ “Retrieve a Report Saved in the CRS” on page 504
- ▶ “Upload Scripts from the CRS to Performance Center” on page 504

### 1 Export a Report to the CRS

By default, the CRS is enabled on the Infrastructure Settings Manager page and you can export the Production Analysis reports to the CRS.

---





**Note:** If the CRS is disabled, re-enable it by selecting **Admin > Platform > Setup and Maintenance > Infrastructure Settings**, choose **Foundations**, select **Production Analysis**, and locate the **CRS Enabled** entry in the Production Analysis - Central Repository Service table. Modify the value to **true**.

---

#### To export a report to the CRS:

- a** From the toolbar at the top right-hand corner of the report, select **Export > Central Repository Service**. A new browser window opens, displaying **Report** under **Type**.



- b** In the **Name** text box, enter the name under which you want to save the report in the repository.
- c** In the **Description** text box, enter a description of the report. This field is optional.
- d** Browse the Root directory tree to select the folder in which you want to save the report. The files that are currently stored in the selected folder are displayed in the Folder Content table on the right.
-  **e** To save the report in a new folder, click the **Create New Folder** button, enter the folder name and description, click **OK**, and then click the **Refresh** button to view the new folder in the directory tree.
-  **f** To rename a folder, click the **Rename Folder** button, enter the new folder name, click **OK**, and then click the **Refresh** button to view the new folder name in the directory tree.
-  **g** To delete a folder, click the **Delete Folder** button and click **Yes**.
-  **h** Click **Save**. If the save process has been completed successfully, **Report saved to repository** is displayed at the top of the browser window.
- i** Click **Close** to close the browser window and return to the report you were viewing.

## 2 Save a Script Template or Scenario Package in the CRS



By default, the CRS is enabled on the Infrastructure Settings Manager page and you can save your generated script templates or a scenario package in the CRS.

---

**Note:** If the CRS is disabled, re-enable it by selecting **Admin > Platform > Setup and Maintenance > Infrastructure Settings**, choose **Foundations**, select **Production Analysis**, and locate the **CRS Enabled** entry in the Production Analysis - Central Repository Service table. Modify the value to **true**.

---

**To save a scenario package or script template in the CRS:**

- a** Click the **Generate Scenario Package** button in the Business Process Distribution report, or the **Generate Script Template** button at the top of the Session details page. A new browser window opens, displaying **Scenario Package** or **VuGen Script** under **Type**.
- b** In the **Name** text box, enter the name under which you want to save the scenario package or script template in the repository.
- c** In the **Description** text box, enter a description of the scenario package or script template. This field is optional.
- d** Browse the Root directory tree to select the folder in which you want to save the scenario package or script template. The files that are currently stored in the selected folder are displayed in the Folder Content table on the right.
-  **e** To save the scenario package or script template in a new folder, click the **Create New Folder** button, enter the folder name and description, click **OK**, and then click the **Refresh** button to view the new folder in the directory tree.
-  **f** To rename a folder, click the **Rename Folder** button, enter the new folder name, click **OK**, and then click the **Refresh** button to view the new folder name in the directory tree.
-  **g** To delete a folder, click the **Delete Folder** button and click **Yes**.
- h** Click **Generate**. If the generation process has been completed successfully, **Scenario package saved to repository** or **VuGen script template saved to repository** is displayed at the top of the browser window.
- i** Click **Close** to close the browser window and return to main page or Session Details page of the Business Process Distribution report.

**3 Open a Script Saved in the CRS**

You can open scripts saved in the CRS from both VuGen and the LoadRunner Controller.

**To open a script saved in the CRS:**

- a** In the main VuGen window, select **Tools > Quality Center Connection**.

- b** In the LoadRunner Controller's New Scenario dialog box, click the **Quality Center** button.
- c** In the Quality Center Connection dialog box, enter the CRS URL, **http://<HP Business Availability Center server machine>:8080/qcbin**, and click **Connect**.
- d** Click **Browse** in the Controller, or select **File > Open** in VuGen, to select the scripts you saved in the CRS. If the scripts were automatically generated by Application Performance Lifecycle, they are located in a zip file within the scenario package file you created.

---

**Note:** When you save your scripts after editing them in VuGen, they are automatically saved in the CRS.

---

#### 4 Retrieve a Report Saved in the CRS

You can retrieve a report saved in the CRS to incorporate its data in your Performance Center load test or LoadRunner scenario.

**To retrieve a report saved in the CRS:**

- a** Access the CRS URL (**http://<HP Business Availability Center server machine>:8080/qcbin**).
- b** Download the report PDF saved in the CRS by clicking the **Download** button. If the report is a Summary report that is part of a scenario package, it can be downloaded from the scenario package zip file.



#### 5 Upload Scripts from the CRS to Performance Center

To incorporate scripts saved in the CRS in your Performance Center load test, you must upload the scripts to the Performance Center Web server.

**To upload scripts from the CRS to Performance Center:**

- a** In the main VuGen window, select **Tools > Quality Center Connection** and open the scripts you saved in the CRS as described in “Open a Script Saved in the CRS” on page 503.



- b** Connect VuGen to the Performance Center Web server as described in *HP Virtual User Generator User's Guide*.
- c** Upload the script files to the Performance Center Web server as described in *HP Virtual User Generator User's Guide*.

## **Application Performance Lifecycle User Interface**

**This section describes:**

- Business Process Distribution Page on page 506
- Location Load Analysis Report on page 512
- Select Locations Dialog Box on page 514
- Select Transactions Dialog Box on page 515
- Typical Transaction Load Report on page 517

## Business Process Distribution Page

<p><b>Description</b></p>	<p>Enables you to:</p> <ul style="list-style-type: none"> <li>▶ View transaction run and transaction response time data over time for the configured transactions monitored by the Real User Monitor.</li> <li>▶ Create VuGen script templates that can be used in a Performance Center load test. You can create a VuGen script template in one of two ways:             <ul style="list-style-type: none"> <li>▶ by instructing Application Performance Lifecycle to automatically generate a script template based on a session it selects</li> <li>▶ by manually selecting the specific session you want to include in your script template</li> </ul> </li> </ul> <p><b>To Access:</b> Select <b>Applications &gt; Application Performance Lifecycle &gt; Production Analysis &gt; Business Process Distribution</b></p>
<p><b>Important Information</b></p>	<p>You can drill down in this report to view data for each session in which the displayed transactions were run.</p> <p><b>Note:</b> If the Central Repository Service (CRS) is enabled, you can export a PDF of the report to the CRS by selecting <b>Export</b> and clicking the <b>Central Repository Service</b> button . For details on exporting the report to the CRS, see “Export a Report to the CRS” on page 501.</p>
<p><b>Included in Tasks</b></p>	<ul style="list-style-type: none"> <li>▶ “Analyze the Business Process Distribution Report” on page 481</li> <li>▶ “Use Application Performance Lifecycle Reports – A Case Scenario” on page 489</li> </ul>

## Report Settings

The following elements are included (unlabeled GUI elements are shown in angle brackets):

GUI Element (A–Z)	Description
<Common report settings>	For details, see “Common Report Elements” in <i>Reports</i> . <b>Note:</b> If you already selected a time range in one of the other Production Analysis reports, the time range you previously selected is automatically displayed in the Business Process Distribution report.

GUI Element (A–Z)	Description
<p><b>Show &lt;nn&gt; transactions &lt;condition&gt; from &lt;application&gt;</b></p>	<p>Select and specify:</p> <ul style="list-style-type: none"> <li>▶ <b>&lt;nn&gt;</b>. The number of real-user transactions you want the report to display.</li> <li>▶ <b>&lt;condition&gt;</b>. Select one of the following: <ul style="list-style-type: none"> <li>▶ <b>with the greatest number of runs</b>. To display the real-user transactions that experienced the highest total number of run instances.</li> <li>▶ <b>with the worst response times</b>. To display the real-user transactions that experienced the greatest overall transaction time.</li> <li>▶ <b>with the highest session popularity</b>. To display the real-user transactions that were most popular among the sessions. Popularity is determined by dividing the number of unique sessions running a transaction by the total number of sessions.</li> <li>▶ <b>with the lowest availability</b>. To display the real-user transactions that experienced the lowest transaction availability.</li> </ul> </li> <li>▶ <b>&lt;application&gt;</b>. Select to display the transactions from all monitored applications (<b>All applications</b>) that meet the selected criteria, or only transactions that were defined for a specific application.</li> </ul>
<p><b>Transaction Selection</b></p>	<p>Select this option and click <b>Transaction Selection</b> to open the Select Transaction dialog box.</p> <p><b>Note:</b></p> <ul style="list-style-type: none"> <li>▶ If you already selected transactions in one of the other Production Analysis reports, these transactions are automatically be selected in the Business Process Distribution report.</li> <li>▶ You can select a maximum of 20 transactions.</li> </ul>

## Summary Table

The following elements are included (unlabeled GUI elements are shown in angle brackets>):

GUI Element (A–Z)	Description
	<p>Select a transaction, based on the total number of runs for the transaction as well as the transaction's session popularity (or response time/availability data), and click the button.</p> <p>The Sessions page opens, displaying data for each session in which the selected transaction was run and a transaction snapshot was collected, as well as certain key statistic averages of all the displayed sessions.</p> <p>For additional information on the Sessions page, see "Session Analyzer Report" in <i>Using End User Management</i>.</p>
<b>Application</b>	The application with which the transaction is associated.
<b>Application Response Time (seconds)</b>	Displays the net time, in seconds, of the transaction (that is, server time + network time + client time of all the pages included in the transaction).
<b>Availability</b>	<p>The transaction's availability.</p> <p><b>Note:</b> The color-coding of the column is based on the transaction's availability in relation to the transaction availability threshold you defined in End User Management Administration.</p>

GUI Element (A–Z)	Description
<p><b>Generate Scenario Package</b></p>	<p>Select one or more transactions and click the button to instruct Application Performance Lifecycle to automatically select a session for each transaction and generate a VuGen script template based on this session.</p> <p>For each transaction, Application Performance Lifecycle selects the session with a combination of the greatest number of runs, the shortest duration, and the least number of errors. Application Performance Lifecycle then generates a VuGen script template based on each session, as well as a Summary report containing the Business Process Distribution report, the Typical Transaction Load report, and the Location Load Analysis report for the selected transactions.</p> <p>If you have enabled the CRS on the Infrastructure Settings Manager page, you are prompted to save the scenario package in the repository. For details on enabling the CRS and saving the package in the repository, see “Save a Script Template or Scenario Package in the CRS” on page 502.</p> <p>If the CRS is not enabled, you are prompted to save the scenario package in your regular directory structure.</p> <ul style="list-style-type: none"> <li>▶ When you click the button the CRS page is displayed, enabling you to generate VuGen script templates. You specify a file name and a description for the script and select a location in the repository in which to save the file.</li> </ul>
<p><b>Popularity</b></p>	<p>The percentage of unique sessions in which the transaction was run over the last day.</p>
<p><b>Total Runs</b></p>	<p>The total number of run instances for the transaction.</p>
<p><b>Transaction</b></p>	<p>The transaction name.</p>

## Transaction Runs Over Time Graph

The following elements are included (unlabeled GUI elements are shown in angle brackets):

GUI Element (A–Z)	Description
<Data points>	Displays for each period of time on the Time axis, the number of transaction runs for the configured transactions monitored by the Real User Monitor. <b>Tooltip:</b> The transaction name and the number of transaction runs.
<Legend>	Describes the color coding used in the graph.
Runs <y-axis>	Displays the number of transaction runs.
Time <x-axis>	Displays the time division units for the time range that you defined when generating the report.

## Transaction Response Time Over Time Graph

The following elements are included (unlabeled GUI elements are shown in angle brackets):

GUI Element (A–Z)	Description
<Data points>	Displays for each period of time on the Time axis, the transaction response time data for the configured transactions monitored by the Real User Monitor. <b>Tooltip:</b> The transaction name and response time.
<Legend>	Describes the color coding used in the graph.
Response Time (ms) <y-axis>	Displays the transaction response time in milliseconds.
Time <x-axis>	Displays the time division units for the time range that you defined when generating the report.

## Location Load Analysis Report

<b>Description</b>	<p>Enables you to view the transaction load (the number of Real User Monitor transaction runs) and bit rate (bits per second) per end-user location.</p> <p>Use the data in this report in configuring Vusers and load generators for your Performance Center load test, as well as the run-time settings for your Application Performance Lifecycle-generated VuGen script.</p> <p><b>To Access:</b> Select <b>Application &gt; Application Performance Lifecycle &gt; Production Analysis &gt; Location Load Analysis</b></p>
<b>Important Information</b>	<p>For details about analyzing the report, see “Analyze a Typical Transaction Load Report” on page 486.</p>
<b>Included in Tasks</b>	<ul style="list-style-type: none"> <li>▶ “Analyze a Typical Transaction Load Report” on page 486</li> <li>▶ “Use Application Performance Lifecycle Reports – A Case Scenario” on page 489</li> </ul>

### Report Settings

The following elements are included (unlabeled GUI elements are shown in angle brackets):

GUI Element (A–Z)	Description
<Common report settings>	<p>For details, see “Common Report Elements” in <i>Reports</i>.</p> <p><b>Note:</b> If you already selected a time range in one of the other Production Analysis reports, the time range you previously selected is automatically displayed in the Location Load Analysis report.</p>



GUI Element (A–Z)	Description
<b>Location Selection</b>	To select locations to be displayed in the Location Load Analysis report, click the link to open the Select Locations dialog box.
<b>Transaction Selection</b>	<p>If you already selected transactions in one of the other Production Analysis reports, by default the Location Load Analysis report displays data for the previously selected transactions.</p> <p>If the Location Load Analysis report is the first Production Analysis report you are accessing, or to display data for a different group of transactions, click the link to open the Select Transaction dialog box.</p>

## Report Content Viewed as a Graph

The **View as Graph** tab includes the following graphs:

### Runs per Location

The following elements are included (unlabeled GUI elements are shown in angle brackets):

GUI Element (A–Z)	Description
<Bars>	<p>Display the total number of transaction runs for each location at which the selected transactions were run.</p> <p><b>Tooltip:</b> The number of transaction runs.</p>
<Legend>	Describes the color coding used in the graph.
Location <x-axis>	Displays the locations.
Total Runs <y-axis>	Displays the number of transaction runs.

## Bitrate

The following elements are included (unlabeled GUI elements are shown in angle brackets):

GUI Element (A-Z)	Description
<Bars>	Display the transaction bit rate (bits per second) for each location at which the selected transactions were run. <b>Tooltip:</b> The transaction bit rate (bits per second).
<Legend>	Describes the color coding used in the graph.
<b>Bitrate (Bits/sec)</b> <y-axis>	Displays the transaction bit rate (bits per second).
<b>Location</b> <x-axis>	Displays the locations.

## Report Content Viewed as a Table

<b>Description</b>	Displays a table listing the bit rate (bits/second) and total number of runs for each transaction at each location, as well as an average of the bit rates and total runs of all the transactions at a location, an average of the bit rates and total runs for each transaction across all locations, and an overall average bit rate and total run calculation for all transactions across all locations.
--------------------	---

## Select Locations Dialog Box

<b>Description</b>	Enables you to select the locations on which you want to run the Location Load Analysis report. <b>To access:</b> Click <b>Location Selection</b> in the Location Load Analysis report.
--------------------	--

The following elements are included (unlabeled GUI elements are shown in angle brackets>):

GUI Element (A–Z)	Description
<b>Locations in the report</b>	Use the first left-pointing arrow to move the appropriate locations from this area to the <b>Locations not in the report</b> area to exclude them from the report. Use the second left-pointing arrow to move all the locations from this area.
<b>Locations not in the report</b>	By default, the Select Locations dialog box displays the locations associated with the transactions you selected. Select the locations for which you want to view data, and click the first right-pointing arrow to move them to the <b>Locations in the report</b> area to include them in the report. To view data for all the locations listed, click the second right-pointing arrow.
<b>Use unknown locations</b>	Select this check box to view data for locations that have not been assigned names.

## **Select Transactions Dialog Box**

<b>Description</b>	Enables you to select the transactions on which you want to run the Business Process Distribution report. <b>To access:</b> Click <b>Transaction Selection</b> in the Business Process Distribution report or <b>Transaction Selection</b> in the Location Load Analysis report.
--------------------	---

The following elements are included (unlabeled GUI elements are shown in angle brackets>):

GUI Element (A-Z)	Description
<b>Application</b>	Select <b>All applications</b> to display the transactions from all monitored applications, or choose a specific application to display only transactions that were defined for that application. Select the transactions for which you want to view data, and click the first arrow. To view data for all the transactions listed, click the second arrow. Click <b>OK</b> to close the dialog box and save your settings.
<b>Transactions in the report</b>	Use the first left-pointing arrow to move selected transactions from this area to the <b>Transactions not in the report</b> area to exclude them from the report. Use the second left-pointing arrow to move all the transactions.
<b>Transactions not in the report</b>	Use the first right-pointing arrow to move selected transactions from this area to the <b>Transactions in the report</b> area to include them in the report. Use the second right-pointing arrow to move all the transactions.

## Typical Transaction Load Report

<b>Description</b>	<p>Enables you to view the average transaction load (the number of Real User Monitor transaction runs) during a typical hour, day, or week within a larger time frame that you select.</p> <p>Use the data in this report to:</p> <ul style="list-style-type: none"> <li>▶ View the typical load on your system during specific time frames, which can assist you in determining the time frame you want to use for your Performance Center load test.</li> <li>▶ Assist you, together with the data in the Business Process Distribution report, in selecting the transactions to include in your VuGen script templates.</li> </ul> <p><b>To Access:</b> Select <b>Application &gt; Application Performance Lifecycle &gt; Production Analysis &gt; Typical Transaction Load</b></p>
<b>Important Information</b>	For details about analyzing the report, see “Analyze the Business Process Distribution Report” on page 481.
<b>Included in Tasks</b>	“Use Application Performance Lifecycle Reports – A Case Scenario” on page 489

## Report Settings

The following elements are included (unlabeled GUI elements are shown in angle brackets):

GUI Element (A-Z)	Description
<Common report settings>	For details, see “Common Report Elements” in <i>Reports</i> . <b>Note:</b> If you already selected a time range in one of the other Production Analysis reports, the time range you previously selected is automatically displayed in the Location Load Analysis report.
<b>Transaction Selection</b>	By default, the Typical Transaction Load report displays data for the transactions you previously selected in the Business Process Distribution report. If the Typical Transaction Load report is the first Production Analysis report you are accessing, or to display data for a different group of transactions, click the <b>Transaction Selection</b> link to open the Select Transactions dialog box.
<b>View a typical...</b>	Select <b>Hour</b> , <b>Day</b> , or <b>Week</b> .
<b>Working Days</b>	Click the <b>Working Days</b> link to open the <b>Working Days</b> dialog box, where you select the days of the week for which data is included in the report. <b>Note:</b> This link is only available when viewing a typical day or hour.
<b>Working Hours</b>	Click the <b>Working Hours</b> link to open the <b>Working Hours</b> dialog box, where you select the hours of the day for which data is included in the report. <b>Note:</b> This link is only available when viewing a typical hour.

## Report Content Viewed as a Graph

The following elements are included (unlabeled GUI elements are shown in angle brackets):

GUI Element (A–Z)	Description
<Bars>	<p>Display the average number of transaction runs for the selected transactions during a typical hour, day, or week within the time frame you specified.</p> <p><b>Note:</b></p> <ul style="list-style-type: none"> <li>▶ Click a bar to drill down to a component of the time period you selected in the <b>View a typical</b> field in report settings. For example, if you have selected a typical week, click on a day in the week to display the data for a typical day.</li> <li>▶ The transaction runs for each sub-unit of time are an average of the transaction runs for all the occurrences of that sub-unit of time during the specified time frame. For example, if you choose to view a typical week during the period of a month, the average number of each of the selected transactions for each day in the week are displayed. The transaction runs listed for a specific transaction on Tuesday are an average of all that transaction's runs on Tuesdays over the course of the specified month.</li> </ul> <p><b>Tooltip:</b> The average number of transaction runs.</p>
<Legend>	Describes the color coding used in the graph.
<Time period> <x-axis>	Displays the sub-units of time for the unit selected in the <b>View a typical</b> field in report settings. For example, if you choose to view a typical week, the individual days of the week are displayed on the <b>Time period</b> axis.
Runs <y-axis>	Displays the number of transaction runs.

## Report Content Viewed as a Table

The following elements are included (unlabeled GUI elements are shown in angle brackets):

GUI Element (A-Z)	Description
<Subunit of time>	The average number of transaction runs for each subunit of time (day, hour or minute), for each selected transaction.
Average <column>	The average number of transaction runs for all subunits of time for each transaction.
Average <row>	The average number of transaction runs for all the transactions for each subunit of time.
Transaction	Transaction name.



# 15

---

## Business Process Recognition

This chapter describes the Business Process Recognition (BPR) application.

### **This chapter includes:**

#### **Concepts**

- ▶ Business Process Recognition Application – Overview on page 521
- ▶ Business Process Recognition Architecture on page 523

#### **Tasks**

- ▶ Convert Real User Monitor Data into Business Process Recognition Data on page 524
- ▶ Deploy Business Process Recognition and Analyze the Results on page 525
- ▶ Customize Business Process Recognition on page 527

#### **Reference**

- ▶ Business Process Recognition User Interface on page 528

### **Business Process Recognition Application – Overview**

Use the Business Process Recognition (BPR) application to discover business processes that can help you monitor what really matters.

The application uses a Web mining algorithm to discover frequently occurring process/transaction patterns in the use of Web applications. Such patterns could indicate business processes.

The Business Process Recognition application is part of the APL (Application Performance Lifecycle) package. As part of Application Performance Lifecycle it extends the abilities of the Real User Monitor solution. Business Process Recognition works on Real User Monitor raw data (session click streams kept in the Real User Monitor MySQL database). This data is first processed into Business Process Recognition format and then can be used as an input to the Business Process Recognition reports applet that discovers business processes and other useful information.

Both the administration applet and the reports applet work in the context of specific Real User Monitor defined applications.

The user selects to run the discovery on specific pages that are Business Critical Pages, on all pages (by giving them a new unique Id), or on both types of pages. Business Critical Pages are the pages you configure for an application in End User Management Administration.

You can discover business processes day by day up to a maximum of 40 days. When you want to run the discovery on additional days above the maximum, you must remove the equivalent number of days from the planned discovery. Data is accumulated using a scheduled process, around midnight on the scheduled day. To configure the maximum number of processing days, see “Modify the Maximum Number of Processing Days per Application” on page 527.

You can also perform emergency import of data. After the data is gathered from the Real User Monitor engine files, the discovery is run on all files that include data. One applet is used for configuration and one applet for reports. The process may take a while, and can also lower Real User Monitor performance during business hours.

On the days you analyze the data, you can tune the discovery as follows:

- ▶ Specify the minimum session length (minimum number of pages in the session)
- ▶ Remove duplicate pages (automatically refreshed pages for example)
- ▶ Ignore meaningless pages. For example, if your application pings the server regularly, the ping page has no business meaning and can be ignored.

- Include sessions that contain specific pages. For example, if you would like to find out why users leave the site after a certain page, filter only sessions that include this page, so BPR can find the most common business processes which lead to leaving the application through this page.

Before generating the report, you must schedule the import and conversion of data from the Real User Monitor. After you generate the report, the discovery is run on the imported data. The **HPWebAlgorithm.exe** process (the data mining/analysis process) takes place on the client machine and might have an impact on the CPU.

While running, the report is saved in the temporary memory/file, which is erased at the end of the session. You can save the report or export it to a recipient who can then open the file in the Business Process Recognition application.

## Business Process Recognition Architecture

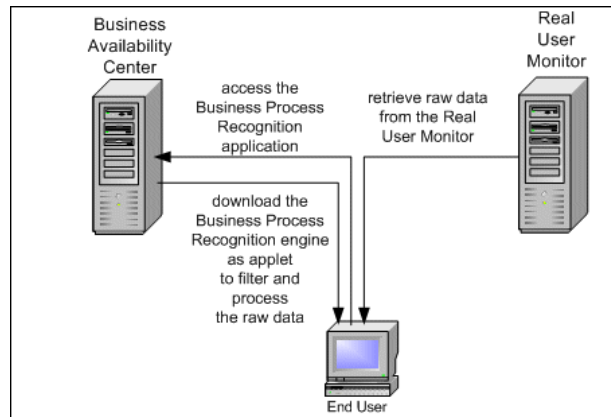

The Business Process Recognition process retrieves data from the Real User Monitor database at night. The data is then converted to reduce the data size.

Once Real User Monitor sessions are exported into small size format you can start to filter/manipulate the data. From this point, you can run the algorithm over and over again with no effect on the Real User Monitor engine and database.

You can filter the data by the number of pages in the session. You can remove duplicate consecutive pages, ignore pages, include sessions that include specific pages, and so on.

## **Convert Real User Monitor Data into Business Process Recognition Data**

This section describes the processes used to convert the Real User Monitor data into Business Process Recognition data.

To convert Real User Monitor data into Business Process Recognition data, click **Application > Application Performance Lifecycle > Business Process Recognition > Business Process Recognition Settings** and specify how to process Real User Monitor sessions data into Business Process Recognition format, and schedule the dates on which to process the data.

---

**Note:** Business Process Recognition tasks automatically stop after two hours of processing, whether or not they have completed, to avoid placing a heavy load on Real User Monitor resources. Tasks stopped before completion are marked as successful and are available for analysis, but only contain the Real User Monitor traffic up to the time they stopped and not for the entire date as configured.

---

For details, see “Business Process Recognition Settings Page” on page 530.

## **Deploy Business Process Recognition and Analyze the Results**

This task describes how to run the Business Process Recognition tool and analyze the resulting data.

This task includes the following steps:

- “Set Up Business Process Recognition” on page 525
- “Customize Business Process Recognition” on page 526
- “Generate and Analyze the Report” on page 526

### **1 Set Up Business Process Recognition**

Once Business Process Recognition data is available, create a report by clicking **Application > Application Performance Lifecycle > Business Process Recognition > Business Process Recognition Settings**, select the date range, and filter the pages on which you want to run the Business Process Recognition tool.

For details, see “Business Process Recognition Tool Page” on page 532.

## 2 Customize Business Process Recognition

You can modify:

- ▶ the default threshold settings for brownouts. For details, see “Modify the Threshold Defaults for Brownouts” on page 527.
- ▶ the maximum number of exported days for each application. For details, see “Modify the Maximum Number of Processing Days per Application” on page 527.
- ▶ the maximum size of the results. For details, see “Modify the Number of Business Processes That Can be Displayed in the Main View” on page 527.

## 3 Generate and Analyze the Report

Click Business Process Recognition tools, select the application, select the report data, and click the **Generate** button. The applet downloads the Business Process Recognition data in the requested time range, filters the data to find business processes, and runs the data mining algorithm to find the business processes. Use the different filters to tune the data you want to display and use the buttons in the report to configure the graph. You can then analyze the displayed data.

For details, see “Business Process Recognition Tool Page” on page 532.

## **Customize Business Process Recognition**

You can customize Business Process Recognition using the following options:

### **1 Modify the Threshold Defaults for Brownouts**

To modify the default threshold settings for brownouts, select **Admin > Platform > Setup and Maintenance > Infrastructure Settings**, choose **Applications**, select **Business Process Recognition**, and locate the **Critical threshold**, **Major threshold**, **Minor threshold**, and **Warning threshold** entries in the **Business Process Recognition - Brownout Settings** table. Modify the value of those thresholds.

### **2 Modify the Maximum Number of Processing Days per Application**

To modify the maximum number of processing days per application, select **Admin > Platform > Setup and Maintenance > Infrastructure Settings**, choose **Applications**, select **Business Process Recognition**, and locate the **Maximum export days** entry in the **Business Process Recognition - Parameter Settings** table. Modify the value of this entry.

### **3 Modify the Number of Business Processes That Can be Displayed in the Main View**

To modify the number of Business Processes that can be displayed in the main view of the Business Process Recognition Tool, select **Admin > Platform > Setup and Maintenance > Infrastructure Settings**, choose **Applications**, select **Business Process Recognition**, and locate the **Maximum results size** entry in the **Business Process Recognition - Parameter Settings** table. Modify the value of this entry. Default is 100.

## Business Process Recognition User Interface

### This section describes:

- ▶ Advanced Algorithm Setting Dialog Box on page 528
- ▶ Business Process Recognition Settings Page on page 530
- ▶ Business Process Recognition Tool Page on page 532
- ▶ Data Selection Dialog Box on page 541
- ▶ Raw Data Information Page on page 544
- ▶ Select Pages Dialog Box on page 544
- ▶ Unique ID Settings Dialog Box on page 545

### Advanced Algorithm Setting Dialog Box

<b>Description</b>	Enables you to specify if you want to find Business Processes, by their popularity level, automatically using an algorithm or manually.  <b>To Access:</b> Click <b>Advanced Algorithm Settings</b> in the Data Selection dialog box.
<b>Important Information</b>	The quality of a Business Process is characterized by its length (number of pages) and its popularity. The popularity is defined by percentage of sessions where the sequence of pages that represents the Business Process is included.

The following elements are included (unlabeled GUI elements are shown in angle brackets>):

GUI Element (A–Z)	Description
<b>Business Process length</b>	Specify the minimum and maximum number of pages in the Business Process.
<b>Business Process minimal length</b>	Specify the minimum number of pages in the Business Process.







GUI Element (A–Z)	Description
<b>Business Process popularity initial level</b>	Select the popularity level that interests you the most.
<b>Manual mode</b>	Select to manually set the algorithm parameters.
<b>Popularity level</b>	Select the minimum and maximum popularity levels.
<b>Smart mode</b>	<p>Select to make the Web mining algorithm run in smart mode.</p> <p>Smart mode automatically runs the algorithm with a high popularity level. It then checks the results and decides one of the following:</p> <ul style="list-style-type: none"> <li>▶ lower the popularity level and run the algorithm again</li> <li>▶ stop the process (when more than 20 results have been discovered) and return the results to the user. This enables you to display the most popular Business Processes.</li> </ul> <p>You can define the initial popularity level to shorten the running time needed for getting the result. For example, if you know (from prior runs) that the maximum popularity level is 25%, set the default at 25% and avoid waiting till the smart mode processes down to this range.</p>

## Business Process Recognition Settings Page

<b>Description</b>	<p>Enables you to manage the processing task and to configure how exactly to process Real User Monitor sessions data.</p> <p><b>To access:</b> Click <b>Application &gt; Application Performance Lifecycle &gt; Business Process Recognition &gt; Business Process Recognition Settings</b></p>
<b>Important Information</b>	<p><b>Limitation:</b> For each application you can process only 40 days. The current status appears in the upper right corner of the month view (for example: 20 out of 40 export days in use). When reaching the quota of 40 days, clean some of existing dates to enable defining more dates. This value is customizable. For details, see “Modify the Maximum Number of Processing Days per Application” on page 527.</p>
<b>Included in Tasks</b>	<p>“Convert Real User Monitor Data into Business Process Recognition Data” on page 524</p>

The following elements are included (unlabeled GUI elements are shown in angle brackets>):

<b>GUI Element (A–Z)</b>	<b>Description</b>
	Cancels the processing tasks that were assigned to the selected dates.
	Clears the processed data that exists for the selected dates. This date becomes available for reprocessing.





GUI Element (A–Z)	Description
	<p>Activates the processing tasks immediately.</p> <p><b>Note:</b></p> <ul style="list-style-type: none"> <li>▶ The task processes each date one day at a time. The processing task takes time and depends on the amount of session click streams for the selected data and on the availability of the Real User Monitor engine.</li> <li>▶ This operation is not recommended for day to day use, except for testing or troubleshooting purposes. It is recommended, instead, to use the <b>Process Selected Date</b> option.</li> </ul> <p><b>Note:</b> The process may take a while, and can also lower Real User Monitor performance during business hours.</p>
	<p>Click to schedule a processing task for the dates you selected. You can select a range of dates and apply the selected schedule for the range.</p> <p><b>Note:</b> This operation only schedules a future task for the Real User Monitor engine.</p>
<Legend>	<p>The legend describes the meaning of the possible colors of the cells in the calendar.</p>
<b>Application</b>	<p>Select the Real User Monitor application.</p>
<b>Clear downloaded data from local Client machine</b>	<p>Select to remove the data downloaded from the Real User Monitor server from the local Client machine.</p> <p>Clear the option to save the data downloaded from the Real User Monitor server on the local Client machine after you close the session.</p>
<b>Next Month with Data</b>	<p>Click to display the next month, if it includes data. If the next month does not include data, the month after that is displayed, if it includes data, and so forth.</p>
<b>Previous Month with Data</b>	<p>Click to display the previous month, if it includes data. If the previous month does not include data, the month before that is displayed, if it includes data, and so forth.</p>

GUI Element (A–Z)	Description
<b>Refresh</b>	Updates the calendar view to show when the operation started at the time you clicked the button for the immediate activation of processing tasks  .
<b>UID Setting</b>	Click to open the Unique ID Settings dialog box.

## Business Process Recognition Tool Page

<b>Description</b>	<p>Helps you discover frequently used processes/ transactions patterns that might represent Business Processes. Also generates and displays multiple reports that provide data about the discovered Business Processes, simultaneously. Each tab on the application displays a different business process report.</p> <p><b>To access:</b> Click <b>Application &gt; Application Performance Lifecycle &gt; Business Process Recognition &gt; Business Process Recognition Tool</b></p>
<b>Important Information</b>	<ul style="list-style-type: none"> <li>▶ You can close a tab (report), print it, save it, rename it, and create a new tab.</li> <li>▶ Only the first 100 Business Processes are displayed.</li> <li>▶ For more information about the Business Process Recognition, see “Business Process Recognition Application – Overview” on page 521.</li> <li>▶ <b>Customization:</b> You can customize the number of Business Processes that can be displayed. For details, see “Modify the Number of Business Processes That Can be Displayed in the Main View” on page 527.</li> </ul>
<b>Included in Tasks</b>	“Deploy Business Process Recognition and Analyze the Results” on page 525

The following elements are included (unlabeled GUI elements are shown in angle brackets>):

GUI Element (A–Z)	Description
 * New	Click to create a new Business Process Recognition report. A new tab is created in the page.
 Open	Click to open an existing Business Process Recognition report. For example, use this option to open a report that was sent to you.
 Print	Click to print the report.
 Save	Click to save the changes.

## Business Process Recognition Filter Area



The following elements are included (unlabeled GUI elements are shown in angle brackets):







GUI Element (A-Z)	Description
<Tabs>	<p>Each discovered business process report is displayed on a separate tab. A new tab is created with a default name when you click <b>New</b>. Right-click the tab to display the following options:</p> <ul style="list-style-type: none"> <li>➤ <b>Rename</b>. Opens the Rename dialog box where you can change the name of the tab.</li> <li>➤ <b>Close</b>. Closes the current tab.</li> <li>➤ <b>Close All Other Tabs</b>. Closes all tabs except the current one.</li> <li>➤ <b>Close All</b>. Closes all the tabs.</li> <li>➤ <b>New</b>. Creates a new tab.</li> </ul>
<b>Applications</b>	<p>Select the Real User Monitor application.</p> <p>Information about the date and the size of the data that was imported when you generated the report is displayed on the right of the Applications box. For example:</p> <div style="border: 1px solid black; padding: 2px; width: fit-content; margin: 5px auto;">Date: May 9, 2007-May 9, 2007, Session size: 5-200</div>
<b>Generate</b>	Click to generate a report.
<b>Select Report Data</b>	Click to open the Data Selection dialog box where you can select the data on which the report is based. For details, see “Data Selection Dialog Box” on page 541.

## Results Area

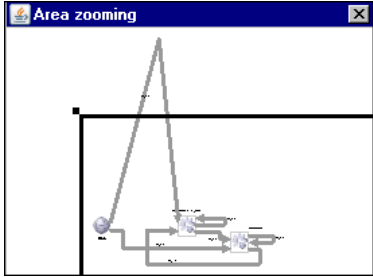

<b>Description</b>	<p>By default, in each tab, the business processes are grouped into one presentation layer. Initially, every page that appears on several business process appears only once on the generated report.</p> <p>You can then filter the pages, group or ungroup pages, and select buttons to display different aspects of the data.</p>
<b>Important Information</b>	<p>Using the buttons and options available on this panel, you modify how you display the report (without changing the actual contents).</p> <p>You can adjust the business process display so that each business process is displayed separately even if it has a shared page with other business processes.</p> <p>You can also select to display business processes that include specific pages.</p> <p>You can:</p> <ul style="list-style-type: none"> <li>▶ show only business processes with specified pages.</li> <li>▶ group pages (aggregate business processes to find the common paths between them).</li> <li>▶ ungroup pages (view each business processes separately).</li> </ul>

The following elements are included (unlabeled GUI elements are shown in angle brackets>):

GUI Element (A–Z)	Description
	<p>Click to return the graph to the original layout. The layout displays the percentage of participation of a page compared to the total number of sessions of the Business Process.</p>
	<p>Display the current report raw data information (sessions include, average sessions size and more). For details, see “Raw Data Information Page” on page 544.</p>

GUI Element (A-Z)	Description
	<p>Select a page and click the button to open the Define Page dialog box in the EUM Administration, where you can create a Business Critical Page corresponding to the selected RUM page. The page is saved in End User Management as a Business Critical page. For details, see “Define Page Dialog Box” in <i>Using End User Management</i>.</p>
	<p>Select two or more pages that you defined as Business Critical Pages and click the button to open the Define Transaction dialog box, where you can create a transaction that is saved in End User Management.</p> <p><b>Note:</b> If you select a page that is not defined as a Business Critical Page, the transaction creation fails.</p>
	<p>Fit the complete view in the window. If, for example, you have enlarged the view in such a way that it does not fit in the window, click the button, to shrink the graph so that it fits in the window.</p>
	<p>To move pages, click the button, select pages and drag them to the required location. To curve a link, click the button, click the link where you want to give it a curve, and drag until you obtain the right curve.</p>
	<p>Click the button. A small window opens. Drag the rectangle in that window to magnify the corresponding area in the main view.</p> 
	<p>Click the button and click and drag the graph to shift the location of the complete graph in the main view.</p>

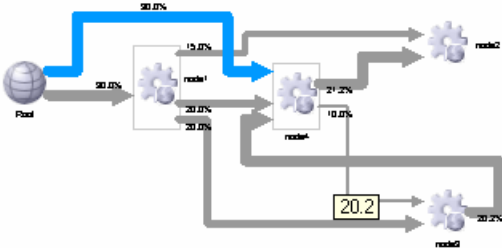

GUI Element (A–Z)	Description
	<p>Click the button, click the graph in the main view, move the cursor up to shrink the graph, and move the cursor down to enlarge the graph.</p>
	<p>Click to toggle the display of the minimum and maximum number of flows that include the page.</p>  <p>The diagram illustrates a process flow starting from a 'Prod' node (represented by a globe icon). The flow splits into three paths: one to 'resid1' (15.0%), one to 'resid2' (21.2%), and one to 'resid3' (20.2%). A box labeled '20.2' is connected to the 'resid3' node. The flow from 'Prod' to 'resid1' is 30.0%, and the flow from 'resid1' to 'resid2' is 15.0%. The flow from 'Prod' to 'resid3' is 20.0%, and the flow from 'resid3' to 'resid2' is 10.0%. The flow from 'resid1' to 'resid3' is 20.0%.</p>

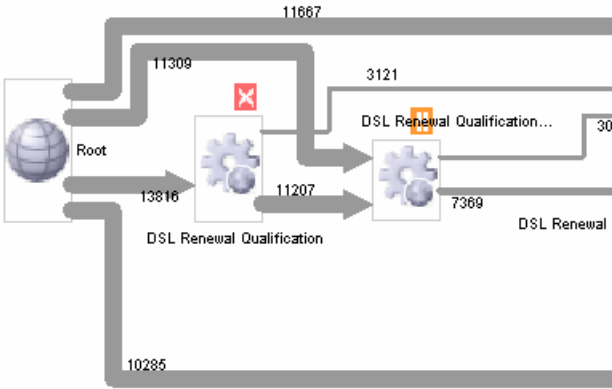
GUI Element (A-Z)	Description
	<p>Click to display the percentage of brown-out for the pages (a page is brownout when the incoming traffic is larger than the outgoing traffic, for example, the incoming traffic is 75% while the outgoing traffic is 35%).</p>  <p>The colors of the brown-out levels are as follows:</p> <ul style="list-style-type: none"> <li>➤ <b>Green.</b> 0%-25% (Normal)</li> <li>➤ <b>Yellow.</b> 25% - 35% (Minor)</li> <li>➤ <b>Light olive.</b> 35% - 55% (Warning)</li> <li>➤ <b>Orange.</b> 55% - 75% (Major)</li> <li>➤ <b>Red.</b> 75% - 100% (Critical)</li> </ul> <p><b>Customization:</b> You can change the threshold values. For details, see “Customize Business Process Recognition” on page 526.</p>

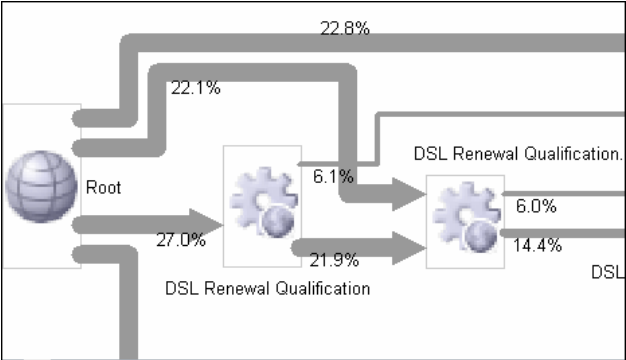
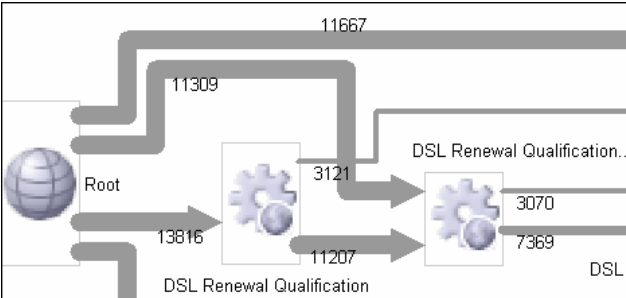
GUI Element (A-Z)	Description
	<p>Toggle to display the diagram with:</p> <ul style="list-style-type: none"> <li>► Percentage values:                      </li> <li>► Accurate values:                      </li> </ul> <p><b>Note:</b> The diagram is initially displayed with percentage values.</p>

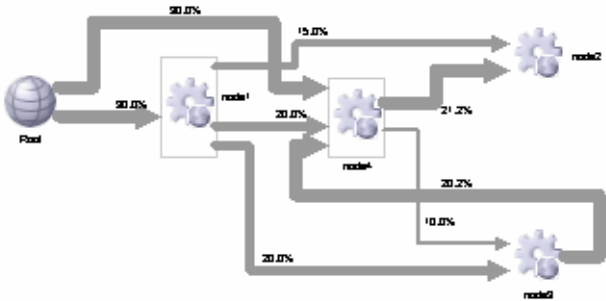
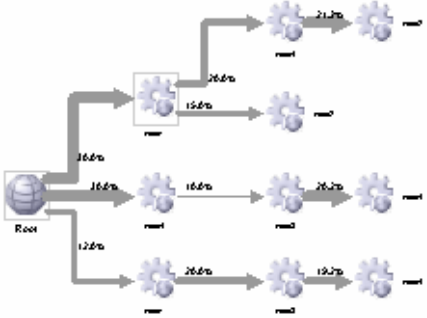
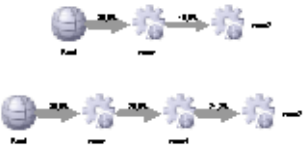
GUI Element (A–Z)	Description
<p><b>Group by:</b></p>	<p>Select:</p> <ul style="list-style-type: none"> <li> <p>➤ <b>Identical linked pages.</b> Superimposes identical pages that have links to identical pages and superimposes the links.</p>  </li> <li> <p>➤ <b>Identical pages.</b> Creates a separate path for each link to a different page or when the percentage of links to the same page is different for different Business Processes. Similar pages are displayed one under the other so you can see each link separately.</p>  </li> <li> <p>➤ <b>Do not group.</b> Shows each Business Process individually.</p>  </li> </ul>

GUI Element (A–Z)	Description
<b>View Business Processes Containing Page</b>	Select to open the Select Pages dialog box where you can select the pages you want to display. The dialog box displays all the pages that are displayed in the graph in the Results area.

### Displayed Business Process Pages Area

<b>Description</b>	Shows details about all the pages that were discovered during the Business Process Recognition process and that appear in the graph.
--------------------	--

The following elements are included (unlabeled GUI elements are shown in angle brackets>):

GUI Element (A–Z)	Description
<b>Max Popularity</b>	Displays the highest number of times the page was included in any of the discovered Business Processes.
<b>Min Popularity</b>	Displays the least number of times the page was included in any of the discovered Business Processes.
<b>Nbr. of Business Processes Using the Page</b>	The number of discovered Business Processes in which this page is included.
<b>Page Name</b>	The unique page ID or the name of the page.

### Data Selection Dialog Box

<b>Description</b>	Enables you to select the data on which the Business Process is to be discovered. <b>To Access:</b> Click <b>Select Report Data</b> in the Business Process Recognition Reports page.
<b>Included in Tasks</b>	“Convert Real User Monitor Data into Business Process Recognition Data” on page 524

### Pages Filter Area

The following elements are included (unlabeled GUI elements are shown in angle brackets>):

GUI Element (A–Z)	Description
<b>Ignore selected pages</b>	Lists the pages that you selected to filter out in the Select Pages dialog box.
<b>Remove consecutive duplicate pages</b>	Select to ignore multiple consecutive instances of the same page (leave only one instance). For example, if the session includes the following sequence of hits: login, choose package, choose package, choose package, submit, it is reduced to: login, choose package, submit.
<b>Select Pages</b>	Click to open the Select Pages dialog box. You can filter out pages that are common and that have no impact on the business (for example, Welcome page).

### Sessions Filter Area

The following elements are included (unlabeled GUI elements are shown in angle brackets>):

GUI Element (A–Z)	Description
<b>Include only sessions that contain the following page</b>	Lists the pages that must be included in the session. For example, sessions that include the log out page.
<b>Include only sessions that have more than &lt;min&gt; or less than &lt;max&gt; number of pages</b>	Specify the <b>minimum</b> and <b>maximum</b> number of pages of the session. Helps you ignore sessions that are too short or too long.  By default, those values are 5 and 200.
<b>Select Pages</b>	Click to open the Select Pages dialog box.

## Date Filter Area

<b>Description</b>	Enables you to select which date you want to analyze (remember that first you have to process them into BPR format using the administration applet).
<b>Important Information</b>	The colors of the cells in the date table indicates whether the date has been selected, there is data available for processing at that date, and the current date.

The following elements are included (unlabeled GUI elements are shown in angle brackets):

<b>GUI Element (A–Z)</b>	<b>Description</b>
<Legend>	The legend describes the meaning of the possible colors of the cells in the calendar.
<b>Advanced algorithm setting</b>	Click to open the Advanced Algorithm Setting dialog box.
<b>Clear All</b>	Click to clear the dates you selected for the month.
<b>Next Month with Data</b>	Click to display the next month, if it includes data. If the next month does not include data, the month after that is displayed, if it includes data, and so forth.
<b>Previous Month with Data</b>	Click to display the previous month, if it includes data. If the previous month does not include data, the month before that is displayed, if it includes data, and so forth.
<b>Selected Date Summary</b>	Click to display the selected dates. The legend below the monthly calendar indicates the selected dates, the days that have data assigned to them, and the non-selectable data.
<b>View Selected Date</b>	Click to display the dates you selected.

## Raw Data Information Page

<b>Description</b>	<p>Displays raw data information about the report and about the algorithm parameters that were used to run the report.</p> <p><b>To access:</b> Click the  button in the Business Process Recognition Tool Page.</p>
--------------------	---

## Select Pages Dialog Box

<b>Description</b>	<p>Enables you to select the pages that are to be ignored when running Business Process Recognition.</p> <p><b>To Access:</b> Click <b>Edit</b> in the Pages filter area of the Select Report Data dialog box.</p>
--------------------	--

The following elements are included (unlabeled GUI elements are shown in angle brackets):

<b>GUI Element (A–Z)</b>	<b>Description</b>
<arrows>	Click the single arrows to select/unselect the selected elements. Click the double arrows to select/unselect all the elements at a time.
<b>Filter</b>	<p>Enter a string to help you filter the list below.</p> <p>The string behaves as if it had a star (*) wildcard before and a star (*) wildcard after - you do not need to enter those characters.</p> <p>You can also insert a star (*) wild card in the string.</p>
<b>Selected pages</b>	Select the pages and click the arrows to move the selection back to the <b>Unselected pages</b> box.
<b>Unselected pages</b>	Lists the available pages. Select them using the filter or select the pages and click the arrows to move the selection to the <b>Selected pages</b> box.



## Unique ID Settings Dialog Box

<b>Description</b>	<p>Enables you to specify the export method and the URL ID setting.</p> <p><b>To Access:</b> Click the <b>URL Unique ID Setting</b> button in the <b>Business Process Recognition Settings</b> dialog box.</p>
<b>Important Information</b>	<p>The first step in analyzing a web application depends on the ability to identify its pages. Since the same page in a web application probably has different URLs due to different session ID, end users, and other parameters, it is important to configure how to identify the same page across all sessions. To do so, you must supply to the Business Process Recognition application a simple configuration that helps it to identify pages.</p> <p>The unique ID can rely on existing naming methods (Business Critical Pages and the meaningful names feature).</p>

The following elements are included (unlabeled GUI elements are shown in angle brackets>):

GUI Element (A–Z)	Description
<b>Add/Remove</b>	Use to add or remove specific parameters.
<b>Export method</b>	<p>Select one of the following:</p> <ul style="list-style-type: none"> <li>▶ <b>Use only named hits (Business Critical Pages and named pages).</b> To use the business critical pages that are defined in End User Management Administration and pages to which meaningful names were given.</li> <li>▶ <b>Create unique ID for all hits.</b> To use all pages in the click stream and assign a unique Business Process Recognition ID to each one of them.</li> <li>▶ <b>Both.</b> To provide a unique ID to all pages in the click stream that do not have a name or are not Business Critical Pages. The named pages retain their original name.</li> </ul>

GUI Element (A–Z)	Description
<b>Include URI in Unique ID</b>	Select to specify which components of the URL are used in the generated unique ID. You can select whether to include the URI and set of parameters (GET/POST) that are to be included in the unique ID.
<b>Parameters</b>	<p>Enter the URL parameters. The pages whose URL includes those parameters, which should be referred to for page identification, are included in the export operation.</p> <p>For example, if the source URL is:  <b>http://micrm.hp.com/callcenter_enu/start.swe?SWECmd=GotoPageTab&amp;SWEBID=-1&amp;SWEView=All Service Request List view&amp;SWEC=2&amp;SWETS=&amp;SWEScreen=Service Request Screen&amp;SWEVST=-1&amp;SWEStrCCnt=372&amp;SWECached=1&amp;SWEJFN=top._swe._swejsview.s00</b></p> <p>and you enter the <b>SWECmd</b> and <b>SWEView</b> parameters to identify this page, the result is:  <b>SWECmd=GotoPageTab&amp;SWEView=All Service Request List view</b></p>

---

# Index

## A

- Active Filter dialog box 61
- Add Inrtegration dialog box 415
- API 301
  - byTime function 308
  - configuration 302
  - Dashboard 395
  - data returned 303
  - example queries 309
  - metadata for samples 303
  - permissions 302
  - queries, legacy data 310
  - query limitations 306
  - SQL syntax supported 305
  - time formats 307
  - UCMDB 325
  - Web browser response body 303
  - Web service 305
- apis 299
- Application - Webservices module 21
- Application CI 235
- Application Performance Lifecycle
  - user interface 505
- Application Server CI 235
- application servers page 253
- Availability dimension
  - uninitialized 173
- Availability KPI
  - no color 173

## B

- bit rate, using in configuring script 495
- BPM measurements
  - SAP Systems view 118
- BPM profile 147, 206
- BPM steps CI 234

- BPM Transaction/Location CI 234
- BPM transactions
  - attaching to SAP Application components 150, 208
- Business Availability Center for Siebel 182
  - configuration 211
- Business Process Distribution report 506
- Business Process Insight
  - overview of application 461
- Business Process Monitor 208
  - creating profile for SAP 147, 207
  - invoking a script 243
  - profile 147, 206
- Business Process Monitor Measurements
  - in SAP Systems view 153
- Business Process Monitor profile
  - creating for SAP 134
- Business Process Monitor transactions for SOA
  - run 57
- Business Process Monitoring
  - synchronizing source adapter 149, 207, 219
- Business Process Monitot measurements
  - SAP Systems view 118
- Business Process profile
  - create 40
- Business Process Recognition 521
  - architecture 523
  - deploy and analyze 525
  - overview 521
  - settings 524
  - user interface 528
- Business Process transactions
  - record for Siebel 206

**C**

- CCMS
  - for SAP 146
- CCMS Counters CIs 131
- Central Repository Service (CRS) 501, 506
- Change report
  - SAP 226
  - SOA 43
- CIs
  - SOA 34
- CIs for SAP 155
- CIT Relationships Map dialog box 421
- Configuration File 155
  - details 42
- Configuration File CI 234
  - details 226, 227
- Configuration File page 161
- configuration type
  - UCMDB API 390
- configuring
  - Business Availability Center for Siebel 211
- connection parameters
  - SiteScope 277
- Consumer Summary report 65
- Contained Group CI 235
- Contained Location CI 235
- correlation
  - showing impact 154, 162
- correlation, for Application Performance
  - Lifecycle-generated scripts 494

**D**

- Dashboard API 395
- data aggregation 36
- data API 301
- data collection process
  - EMS 407
  - third-party data 407
- Database Breakdown
  - solving issues 292
- Database CI 235
- default SiteScope monitor
  - specify for Siebel 231

- Define Assignment Configuration
  - dialog box 422
- deployment
  - HP Business Availability for Siebel 194
- Diagnostic tool
  - Siebel Database Breakdown Diagnostic 221, 225
- Diagnostics
  - integrating for SOA solution 24
- diagnostics settings
  - checklist 212
- Diagnostics Tools
  - errors occurring while running 276
- Diagnostics tools
  - troubleshooting 277
- diagnostics tools
  - Siebel 182
- dialog box
  - Select Location 515
  - Select Transaction 513
- discovery 21
  - running SAP discovery 134
- Discovery Agent
  - restart 145
- Discovery and Dependency Mapping 39
- Discovery Probe
  - post-installation procedure 144

**E**

- Edit Integration dialog box 417
- EMS
  - process flowchart 407
- EMS Integration Admin page 424
- EMS integration application
  - overview 402
- EMS integration tool
  - HP Business Process Insight 463
  - HP OVO 429
  - HP ServiceCenter 456
- Enterprise Management Systems
  - integration 401
  - overview 402
- error
  - Cannot Raise Log Level 294
  - Could Not Retrieve Log File 294

- Could Not Run BPM Transaction 294
  - Database Breakdown Analysis Data for the Transaction Cannot Be Displayed 295
- errors
  - troubleshooting in logs 274
- F**
- filtering reports 513, 518
- firewalls
  - working with Siebel 188
- for SOA 21
- G**
- generate SARM report
  - save generated XML files 230
- graphs
  - Transaction Runs per Location 513
- H**
- Health report 71
- Host CI 235
- Host integration adapter 403
- hosts reconciliation 405
- HP Business Availability Center
  - unable to log on 174
- HP Business Availability Center for SAP
  - deploying 141
  - deployment workflow 133
- HP Business Availability Center for Siebel
  - architecture 187
  - license 186
- HP Business Availability Center for Siebel solution 179
- HP Business Availability Center for SOA
  - architecture 19
  - reports 29
  - views 29
- HP Business Availability for SAP
  - architecture 116
  - overview 114
- HP Business Availability for SAP application 113
- HP Business Availability for SAP Applications
  - license 115
- HP Business Availability for Siebel
  - deploying 194
- HP Business Availability for Siebel Applications
  - overview 180
- HP Business Process Insight
  - access from HP Business Availability Center 465
  - integration using EMS integration tool 463
- HP Diagnostics
  - integrating for SOA solution 24
  - integration with Business Availability Center 469
- HP Diagnostics and HP Business Availability Center integration
  - overview 470
- HP Diagnostics data
  - view in HP Business Availability Center 471
- HP Diagnostics Integration
  - enable 39
- HP Diagnostics probes
  - deploy 39
- HP OVO
  - activate view 432
  - add optional KPIs 433
  - assign CIs to SLAs 433
  - customize integration adapter 431, 464
  - customize mapping 432
  - install HP OVO integration add-on 430
  - integration using EMS integration tool 429
  - view data in views 433
- HP OVO integration
  - overview 425
- HP ServiceCenter
  - add optional KPIs 459
  - assign CIs to SLAs 459
  - CIs and KPIs 454
  - configuration 435
  - configure integration adapter 458

## Index

- context menu items and tooltips 455
- customize integration adapter 459
- EMS integration tool 456
- integration 451
  - rules 455
  - view data in views 460
- HP SOA Systinet
  - integration for SOA solution 26
- HP SOA Systinet integration
  - enable 40

**I**

- integration
  - Netscout 461
- integration adapter
  - Host 403
- invoking Business Process Monitor script 243

**J**

- J2EE - WebLogic module 21
- J2EE WebSphere module 21

**L**

- license
  - SAP 142
  - SiteScope 143
  - SOA 39
- limitations
  - HP Diagnostics 472
  - Siebel Log monitor on Unix platform 295
  - SOA reports 110
- links between SAP transactions and BP steps
  - creating automatic links 150, 209
  - creating manual links 151, 209
  - deleting 152, 216
- load test, configuring and running 496
- LoadRunner, configuring and running a scenario in 498
- Location Load Analysis report 512

**M**

- mam\_libpackages 142
- Metrics Over Time reports 85
- Monitor Deployment Wizard
  - Siebel monitors 217
  - using for SOA monitors 55
- monitors
  - creating general monitors for SAP 146
  - set to report all monitors and measurements 137

**N**

- naming conventions
  - BPM transaction automatically linked to SAP transactions 150, 209
  - regular hierarchy 122
  - Transaction/location hierarchy structure 118
- Netscout
  - integration 461
- Netscout integration
  - overview 461
- Network Speed, run-time setting 495
- no-naming convention
  - regular hierarchy structure 123
  - Transaction/location hierarchy structure 120

**O**

- operations
  - customizing number to display in SOA reports 59, 60
- overview
  - Business Process Recognition 521
- OVO
  - CIIs and KPIs 426
  - context menu items and tooltips 428
  - hierarchies 426
  - rules 428
- OVO Hosts and Applications View
  - activate 432

**P**

- parameterization, for Application Performance Lifecycle-generated scripts 493
- parameters.cfg 226, 227
- Performance Center
  - configuring and running a load test in 496
- Performance dimension
  - uninitialized 173
- Performance KPI
  - no color 173
- Problem Isolation report 165
- Processes 295
- Processes report 238
- Processes Tool - Advanced Filter dialog box 240
- profile
  - creating 147
- protocol
  - SAPGUI 147

**Q**

- queries
  - limitations 306
  - UCMDB API 329

**R**

- Real User Monitor
  - convert data into Business Process Recognition data 524
- reconciliation of hosts 405
- Regular Hierarchy
  - Business Process Monitor 208
- relation
  - UCMDB API 391
- relationships details 405
- replaying a session 484
- reporting
  - Dashboard API 395
  - using API 301
- reports
  - access and permissions 35
  - Business Process Distribution 506

- exporting to CRS 501
  - filtering 513, 518
  - Location Load Analysis 512
  - retrieving from CRS 504
  - Typical Transaction Load 517
- rum\_page\_t sample
  - example 310
- rum\_server\_t sample
  - example 310
- run-time settings 147
  - for Application Performance Lifecycle 495

**S**

- SAP
  - CIs 155
  - collecting system information 130
  - creating Business Process Monitor profile 134
  - KPIs 159
  - menu options 160
  - System CIs 226
  - troubleshooting 172
- SAP Application components
  - attaching BPM transactions 150, 208
- SAP BPM scripts
  - not executing 174
- SAP CCMS measurements
  - connecting to elements in SAP 138
- SAP CCMS monitor 146
  - creating 146
  - using to retrieve measurements from SAP system 135
- SAP deployment
  - workflow 133
- SAP dimension
  - uninitialized 172
- SAP discovery
  - running 134
- SAP Service
  - activating 140
  - administering 129
- SAP system
  - monitoring 173

## Index

- SAP Systems view 126
  - BPM measurements 118
- SAP Transaction Changes report 166
- SAP transactions
  - automatic link to BPM transactions 150, 209
- SAP Transport Changes report 169
- SAP users
  - simulation 147, 206
- SAPGUI protocol 147
- SARM
  - Analyzer tool, copying to the SiteScope server 203
  - running the user trace diagnostic 222
- SARM - User Trace Breakdown
  - running 221
- SARM - User Trace Breakdown - Analysis report 246
- SARM - User Trace Breakdown (Run the Diagnostics Tool) page 241
- SARM - User Trace Breakdown dialog box 244
- SARM logs
  - for Web and Application Server 224
- SARM user trace breakdown diagnostic application servers page 253
- SARM-related issues
  - troubleshooting 278
- scenario package
  - generating 510
  - saving in CRS 502
- script
  - editing 148
- script templates
  - generation 485
  - refining in VuGen 492
- scripts
  - invoking Business Process Monitor script 243
  - opening from CRS 503
  - saving in CRS 502
  - uploading to Performance Center 504
- Select Location
  - dialog box 515
- Select Transaction
  - dialog box 513
- Server and Endpoint Summary report 90
- service
  - Siebel 190, 199, 220
- ServiceCenter
  - integration 451
- Session Details page 483, 484
- session replay 484
- Sessions page 509
- Show Content
  - Siebel 226, 227
- Showing Impact report 162
- Siebel
  - context menu options 232
  - Database Breakdown Configuration page 221, 259
  - default CIs 234
  - deploying 194
  - diagnostics tools 182
  - record Business Process transactions 206
  - service 190, 199, 220
  - Show Content 226, 227
- Siebel Application Server Monitor 189
- Siebel Application Server solution template 219
- Siebel CIs
  - manual configuration 198, 200
- Siebel Component CI 235
- Siebel Component Group CI 235
- Siebel Database Breakdown
  - Analysis report 262
- Siebel Database Breakdown Configuration report 259
- Siebel Database Breakdown Diagnostic tool 221, 225
- Siebel Deployment Validator dialog box 264
- Siebel Deployment Validator Test Summary dialog box 269
- Siebel Enterprises CI 236
- Siebel Enterprises View 191
- Siebel Enterprises view
  - errors occurring while building 275
  - troubleshooting 276
- Siebel Gateway CI 236
- Siebel Gateway Server solution template 219
- Siebel Log Monitor 189



- Siebel monitors
    - concepts 189
    - deploying 216
    - deploying using Monitor Deployment Wizard 217
    - deploying using Siebel solution templates 219
  - Siebel solution
    - architecture 187
    - configuring 211
    - license 186
    - troubleshooting 274
  - Siebel Web Server Application CI 236
  - Siebel Web Server Extension CI 236
  - Siebel Web Server Monitor 189
  - Siebel Web Server solution template 219
  - siebel.cfg 226, 227
  - SiteScope
    - attaching SiteScope to HP Business Availability Center for SAP 137
    - connection parameters 277
    - license 143
    - monitors for SOA 28
    - post-installation procedure 143
  - SiteScope CCMS Solution Template 136
  - SiteScope CCMS Solution template
    - using for SAP 136
  - SiteScope Measurement CIs 236
  - SiteScope measurements
    - checking in SAP 124, 140
  - SiteScope monitor
    - manual attach 57
    - specify default for Siebel 231
  - SiteScope monitors
    - deploy 40
    - deploy for SOA solution 55
    - deploying for SOA using Monitor Deployment Wizard 55
    - for SAP 146
    - specify default for Siebel 231
  - SiteScope server
    - copying the srvmgr and the SARM Analyzer tool to 203
  - SiteScope source adapter
    - synchronizing 137
  - SOA
    - CIs 34, 43
    - deploy SiteScope monitors for 55
    - deployment workflow 38
    - discovery patterns for 21
    - information in views 29
    - integrating with HP SOA Systinet 26
    - integration HP Diagnostics data 24
    - SiteScope monitors 28
  - SOA discovery modules 21
  - SOA information in Dashboard 41
  - SOA reports
    - limitations 110
  - SOA solution
    - overview 18
  - Software Component File 155
  - Software Component File page 163
  - solution
    - Siebel 179
  - Speed Simulation settings 495
  - srvmgr tool
    - copying to the SiteScope server 203
  - ss\_t sample
    - example 309
  - Support Package File Information 155
  - Systinet
    - integration for SOA solution 26
- T**
- table information
    - Web services 103, 109
  - Tasks 296
  - Tasks Diagnostics Tool - Advanced Filter dialog box 273
  - Tasks Diagnostics Tool report 271
  - Technology Web Service Integration Monitor 28
  - third-party data
    - process flowchart 407
  - third-party integrations 299
  - timeout
    - changing default for SiteScope monitor 231
    - increasing default for SARM Task or SARM Analyzer 232

## Index

- Top Metrics report 97
  - TopologyMap
    - UCMDB API 329
  - Total Database Time chart 293
  - trans\_t sample
    - example 309
  - Transaction Location Regular Hierarchy 208
  - Transaction Runs per Location graph 513
  - Transaction/Location
    - Business Process Monitor 208
  - troubleshooting
    - HP Diagnostics 472
    - SAP solution 172
    - SARM-related issues 278
  - Typical Transaction Load report 517
- U**
- UCMDB API
    - addCIsAndRelations 352
    - calculateImpact 357
    - chunkInfo 393
    - CIT name 390
    - class name 390
    - configuration type name 390
    - deleteCIsAndRelations 353
    - errors 329
    - exceptions 329
    - executeTopologyQueryByName 345
    - executeTopologyQueryByNameWithParameters 345
    - executeTopologyQueryWithParameters 346
    - getAllClassesHierarchy 355
    - getChangedCIs 337
    - getCIsByID 338
    - getCIsByType 338
    - getClassAncestors 355
    - getCmdbClassDefinition 356
    - getFilteredCIsByType 339
    - getImpactPath 358
    - getImpactRulesByNamePrefix 359
    - getQueryNameOfView 343
    - getTopologyQueryExistingResultByName 344
    - getTopologyQueryResultCountByName 344
    - identifier in impact analysis methods 357
    - key attributes 389
    - labels 329
    - parameter format 350, 388, 392
    - permissions 328
    - query methods 337
    - query, properties returned 334
    - relation 391
    - ShallowRelation 392
    - TopologyMap 329
    - TQL queries 329
    - update methods 352, 355, 357
    - updateCIsAndRelations 354
    - using 327
    - Web service, calling 329
  - UDDI Monitor 28
  - UDDI Registry
    - for SOA 21
  - user trace diagnostic (SARM) 222
- V**
- view
    - OVO Hosts and Applications View 432
    - SAP Systems 126
    - Siebel Enterprises 191
  - views
    - SOA 29
    - Web Services 29
  - VuGen
    - correlating recorded values 494
    - parameterization 493
    - refining script templates 492
- W**
- Web Server CI 236
  - Web Servers - IIS module 21
  - Web service
    - API 305
    - API, data returned 304
    - UCMDB API 325, 329

- Web Service Monitor 28
- Web services
  - customizing number to display in SOA reports 59, 60
  - discovering 21
  - information in views 29
- workflow
  - for deploying SAP 133
  - for deploying SOA 38

